

DWG. NO.
SD-500047-002

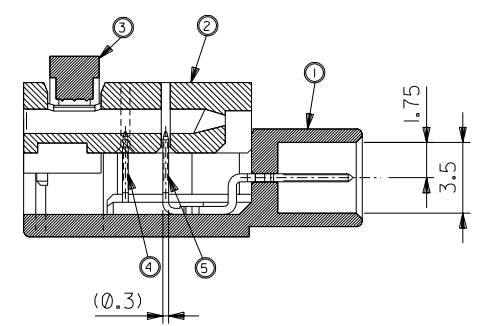
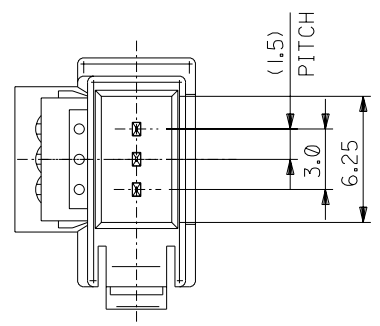
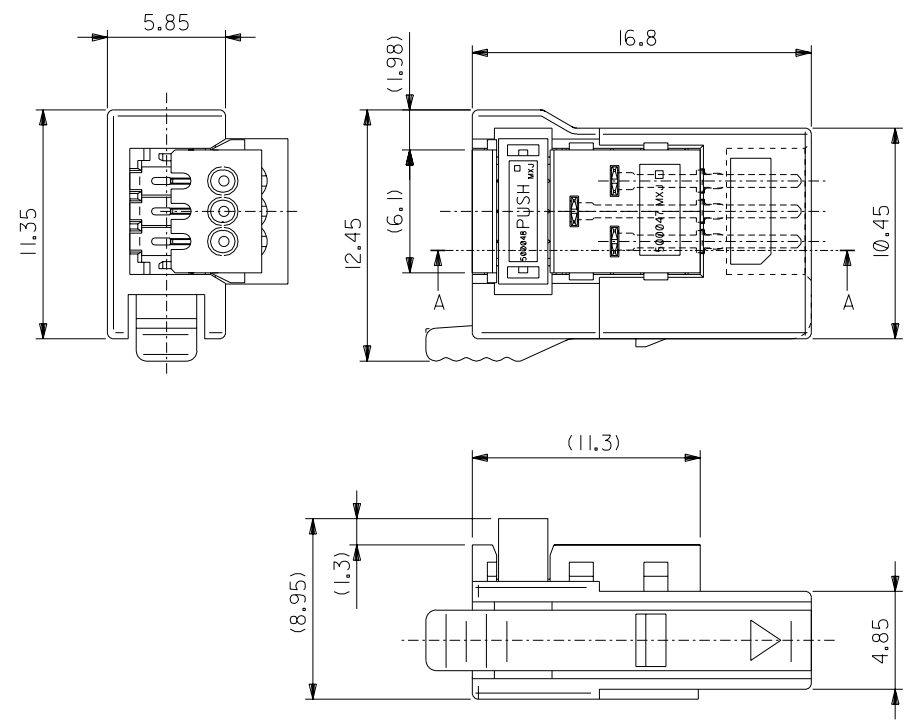

SECT A-A

番号 NO.	部品名 PART NAME	数量 QTY	材料 MATERIAL	色 COLOR	仕上げ FINISH
⑤	ターミナル 4 TERMINAL 4	2	りん青銅 (φ0.4)		接点部：金めっき CONTACT AREA: GOLD PLATING
④	ターミナル 3 TERMINAL 3	1	PHOSPHOR BRONZE (φ0.4)		圧接部：半田めっき LD PORTION: SOLDER PLATING
③	ケーブル ストッパー CABLE STOPPER	1	ポリエスチル、ガラス入り樹脂、UL94V-0 G.F.PBT UL94V-0	白 WHITE	下地：ニッケルのめっき UNDER PLATING: NICKEL PLATING
②	インナー ハウジング INNER HOUSING	1	ポリカーボネート、UL94V-0 PC UL94V-0	無色透明 CLEAR	
①	プラグ ハウジング PLUG HOUSING	1	ナイロン、ガラス入り樹脂、UL94V-0 G.F.NYLON UL94V-0	黒 BLACK	

500047-0300 500047-**00
製品番号 MATERIAL No. MODEL No.

DO NOT SCALE DRAWING

EC NO. DRWN: CHK: APPR:	EC NO. DRWN: CHK: APPR:	EC NO. DRWN: CHK: APPR:	REVISED EC NO. J2002-3248 DRWN: T.NAKANO 02/06/26 CHK: M.YAGI APPR: YO.ITO	RELEASED EC NO. J2002-2642 DRWN: T.NAKANO 02/04/19 CHK: M.YAGI APPR: YO.ITO	DESCRIPTION	MATERIAL 材料 SEE CHART	GENERAL TOLERANCES: (UNLESS SPECIFIED) 一般公差	SCALE 4-1	DESIGN UNITS <input checked="" type="checkbox"/> mm <input type="checkbox"/> INCH	THIRD ANGLE PROJECTION	DIMENSIONS: <input type="checkbox"/> mm <input type="checkbox"/> INCH <input checked="" type="checkbox"/> mm ONLY	SHT REVISE ON CAD ONLY	REV
					FINISH 仕上げ SEE CHART		10 UNDER 未満	±0.2	DRAWN BY & DATE T.NAKANO 02/04/19	TITLE: 1.5mm PITCH EZ CONN 3CKT PLUG ASS'Y			
					WIRE RANGE 適用 線径 範囲 AWG #28		10 OVER 30 UNDER 未満	±0.25	CHECKED BY & DATE M.YAGI 02/04/19	MOLEX MOLEX INCORPORATED			
					INS. RANGE 被覆 外径 φ0.7		30 OVER 以上	±0.3	APPROVED BY & DATE YO.ITO 02/04/19	MATERIAL NO. SEE CHART	DRAWING NO. SD-500047-002	SHEET NO. 1 OF 2	
THIS DRAWING CONTAINS INFORMATION THAT IS PROPRIETARY TO MOLEX INCORPORATED AND SHOULD NOT BE USED WITHOUT WRITTEN PERMISSION.											SIZE B		

DWG. NO.
E-500047-002

F

D

V

C

B

DO NOT SCALE DRAWING

8

7

6

5

4

3

2

1

F

E

D

C

B

SD500047002.S92

ケーブル組立前

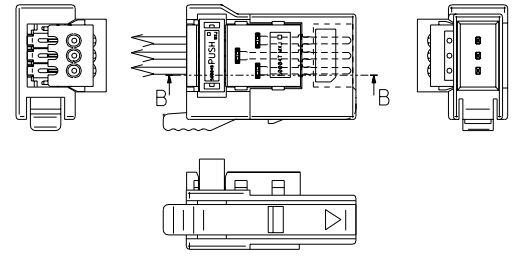

1. インナーハウジングへケーブルを挿入する。
(この時インナーハウジングのケーブル挿入穴奥のテーパによりケーブルが仮止めされる。)

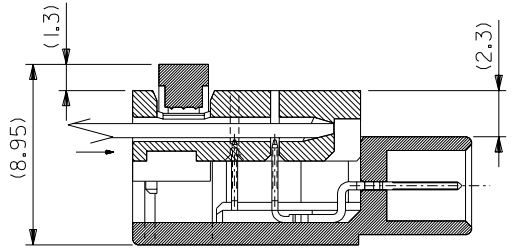

SECT B-B
(SCALE:4-1)

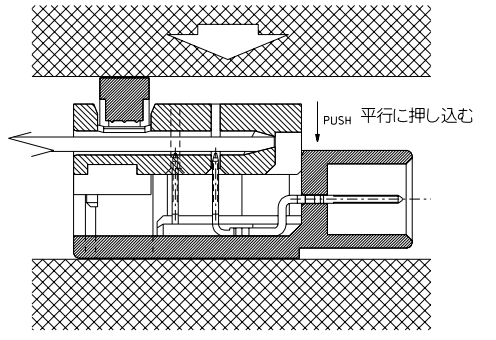

2. ケーブル圧接
プライヤ等の工具もしくは治具にて本コネクタを挟み込み、ケーブルストッパーとインナーハウジング共にプラグハウジングへ平行に押し込む。
この工程にてケーブルの一括圧接を行う。

ケーブル組立後

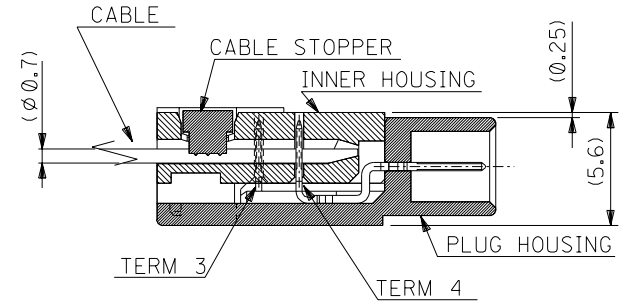
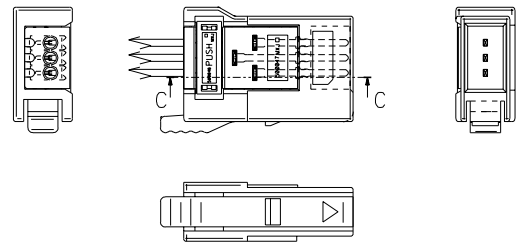

SECT C-C
(SCALE:4-1)

ケーブル組立手順

EC NO. DRWN: CHK: APPR:	EC NO. DRWN: CHK: APPR:	EC NO. DRWN: CHK: APPR:	SEE SHEET 1 OF 2 EC NO. DRWN: CHK: APPR:	SEE SHEET 1 OF 2 EC NO. DRWN: CHK: APPR:	DESCRIPTION	MATERIAL 材料	GENERAL TOLERANCES: (UNLESS SPECIFIED) 一般公差	SCALE 2-1	DESIGN UNITS <input checked="" type="checkbox"/> mm <input type="checkbox"/> INCH	DIMENSIONS: <input type="checkbox"/> mm <input type="checkbox"/> INCH <input checked="" type="checkbox"/> mm ONLY	SHT	REV
						SEE SHEET 1 OF 2	10 UNDER 未満	±0.2	DRAWN BY & DATE T.NAKANO 02/04/19	THIRD ANGLE PROJECTION	TITLE: 1.5mm PITCH EZ CONN 3CKT PLUG ASS'Y	REVISION REVISE ON CAD ONLY
						FINISH 仕上げ	10 OVER 30 UNDER 以上 未満	±0.25	CHECKED BY & DATE M.YAGI 02/04/19			
						WIRE RANGE 適用配線範囲	30 OVER 以上	±0.3	APPROVED BY & DATE YO.ITO 02/04/19			
INS. RANGE 被覆外径	SEE SHEET 1 OF 2	ANGLE 角度	±3°	CAD FILENAME SD500047002.S02	MATERIAL NO. SEE SHEET 1 OF 2	DRAWING NO. SD-500047-002	SHEET NO. 2 OF 2					
THIS DRAWING CONTAINS INFORMATION THAT IS PROPRIETARY TO MOLEX INCORPORATED AND SHOULD NOT BE USED WITHOUT WRITTEN PERMISSION.						MOLEX MOLEX INCORPORATED		SIZE B				

8

7

6

5

4

3

2

EN-02J(097) MXJ-54