



# 15GN03FA

## RF Transistor

10V, 70mA,  $f_T=1.5\text{GHz}$ , NPN Single SSFP

ON Semiconductor®

<http://onsemi.com>

### Applications

- VHF, RF, MIXER, OSC, IF amplifier

### Features

- High cutoff frequency :  $f_T=1.5\text{GHz}$  typ
- High gain :  $|S_{21e}|^2=14\text{dB}$  typ ( $f=0.4\text{GHz}$ )
- Ultrasmall package permitting applied sets to be small and slim
- Halogen free compliance

### Specifications

Absolute Maximum Ratings at  $T_a=25^\circ\text{C}$

Parameter	Symbol	Conditions	Ratings	Unit
Collector-to-Base Voltage	$V_{CBO}$		20	V
Collector-to-Emitter Voltage	$V_{CEO}$		10	V
Emitter-to-Base Voltage	$V_{EBO}$		3	V
Collector Current	$I_C$		70	mA
Collector Dissipation	$P_C$		250	mW
Junction Temperature	$T_j$		150	$^\circ\text{C}$
Storage Temperature	$T_{stg}$		-55 to +150	$^\circ\text{C}$

Stresses exceeding Maximum Ratings may damage the device. Maximum Ratings are stress ratings only. Functional operation above the Recommended Operating Conditions is not implied. Extended exposure to stresses above the Recommended Operating Conditions may affect device reliability.

### Package Dimensions

unit : mm (typ)

7029A-002

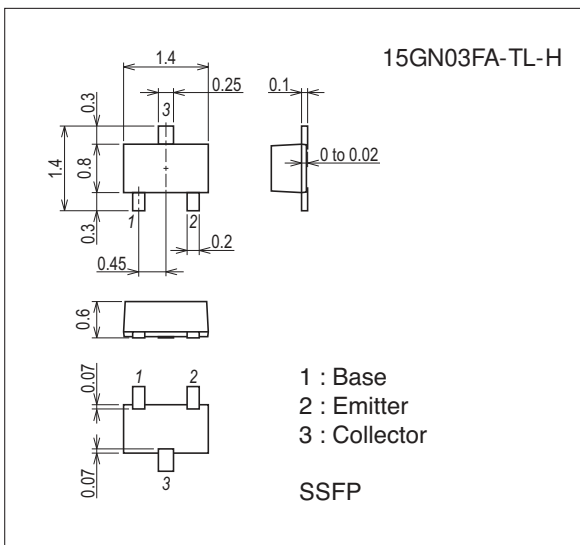

### Product & Package Information

- Package : SSFP
- JEITA, JEDEC : SC-81
- Minimum Packing Quantity : 8,000 pcs./reel

### Packing Type: TL

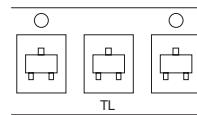

### Marking

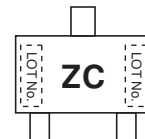

### Electrical Connection

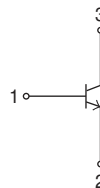

# 15GN03FA

## Electrical Characteristics at Ta=25°C

Parameter	Symbol	Conditions	Ratings			Unit
			min	typ	max	
Collector Cutoff Current	ICBO	V <sub>CB</sub> =10V, I <sub>E</sub> =0A			0.1	μA
Emitter Cutoff Current	IEBO	V <sub>EB</sub> =2V, I <sub>C</sub> =0A			1	μA
DC Current Gain	h <sub>FE</sub>	V <sub>CE</sub> =5V, I <sub>C</sub> =10mA	100		180	
Gain-Bandwidth Product	f <sub>T</sub>	V <sub>CE</sub> =5V, I <sub>C</sub> =20mA	1.0	1.5		GHz
Output Capacitance	C <sub>ob</sub>	V <sub>CB</sub> =10V, f=1MHz		0.9	1.2	pF
Reverse Transfer Capacitance	C <sub>re</sub>				0.6	
Forward Transfer Gain	S <sub>21e</sub>   <sup>2</sup>	V <sub>CE</sub> =5V, I <sub>C</sub> =20mA, f=0.4GHz	11	14		dB
Noise Figure	NF	V <sub>CE</sub> =3V, I <sub>C</sub> =2mA, f=0.4GHz		1.6		dB

## Ordering Information

Device	Package	Shipping	memo
15GN03FA-TL-H	SSFP	8,000pcs./reel	Pb Free and Halogen Free

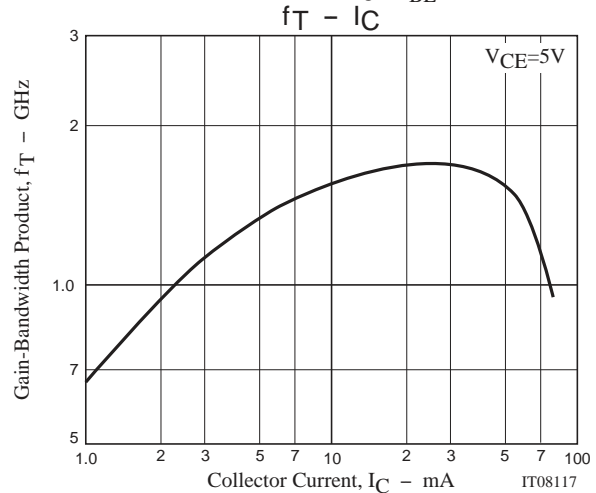
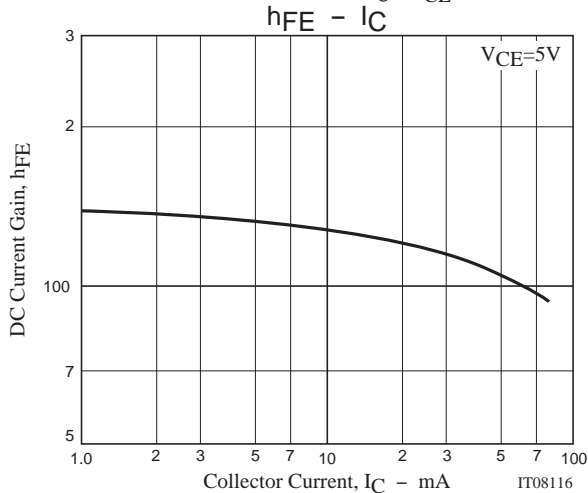
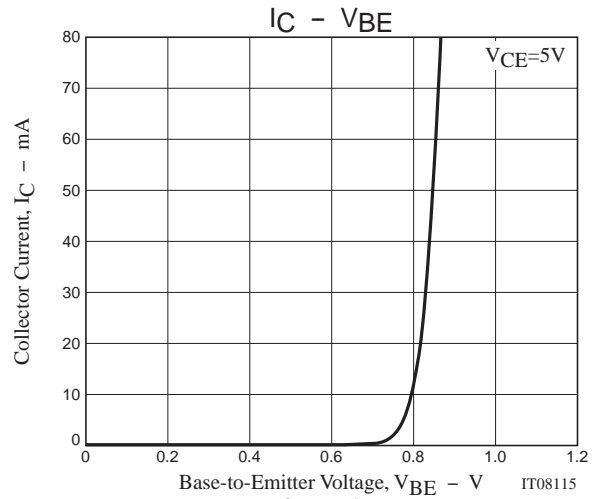
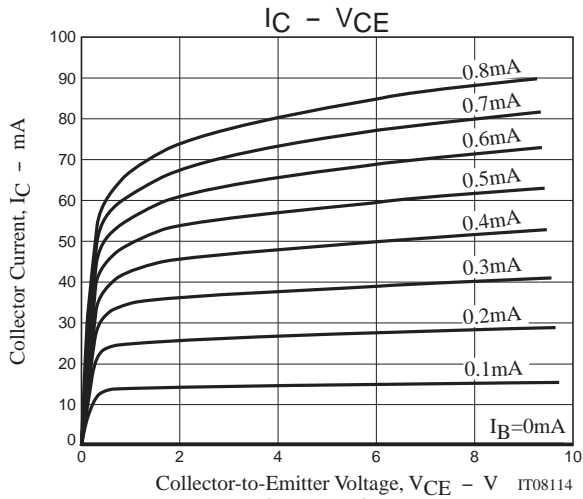

# 15GN03FA

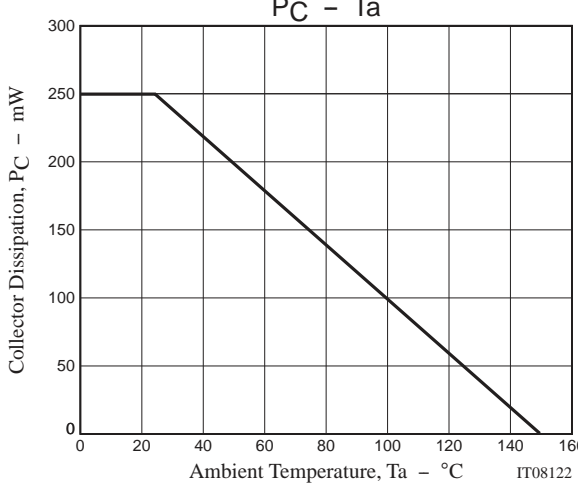
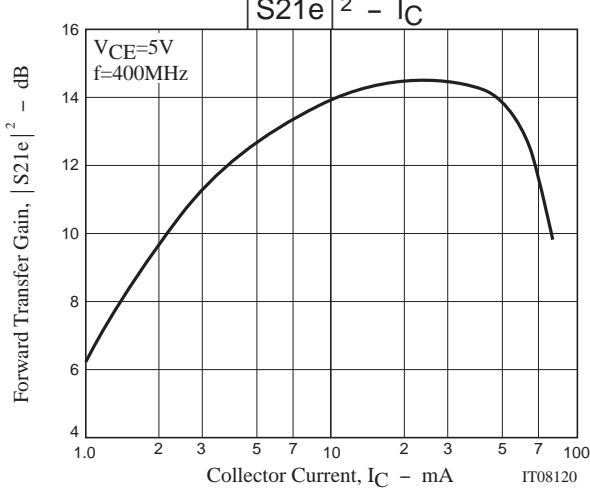
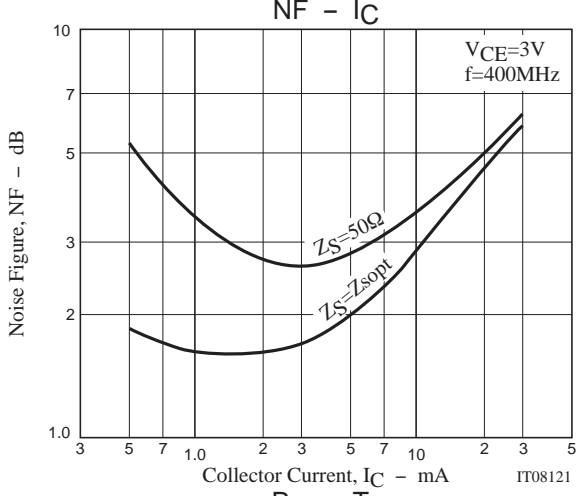
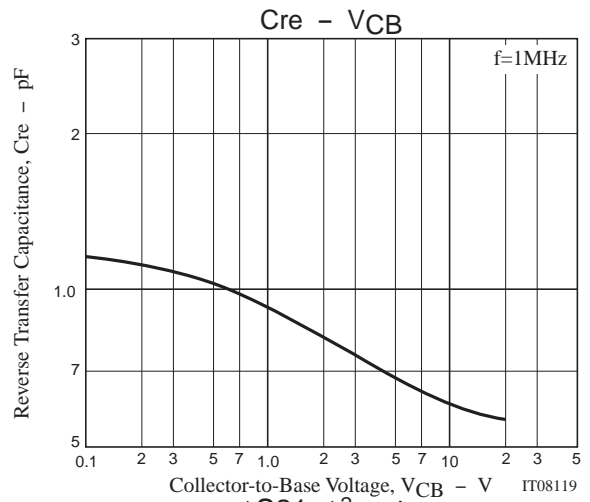
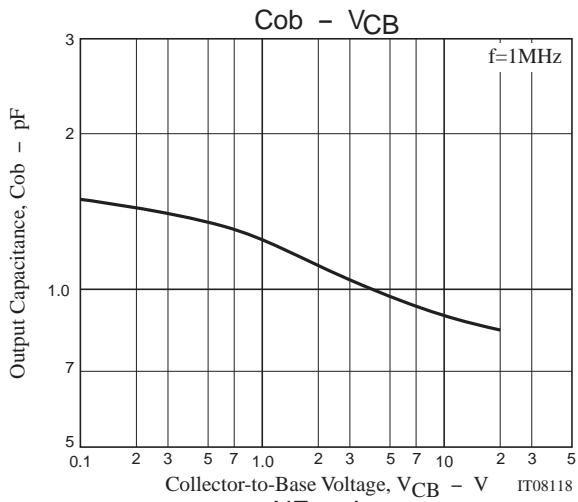

# 15GN03FA

## S Parameters (Common emitter)

$V_{CE}=5V, I_C=1mA, Z_O=50\Omega$

Freq(MHz)	S11	$\angle S11$	S21	$\angle S21$	S12	$\angle S12$	S22	$\angle S22$
100	0.961	-34.18	3.294	157.68	0.040	70.32	0.974	-8.70
200	0.932	-63.71	2.882	139.23	0.068	53.42	0.920	-15.14
300	0.907	-86.85	2.472	124.36	0.087	40.84	0.873	-19.79
400	0.887	-104.47	2.112	112.52	0.096	32.90	0.842	-23.48
500	0.871	-117.78	1.834	102.94	0.099	28.12	0.818	-26.33
600	0.859	-128.62	1.605	94.86	0.101	23.64	0.802	-29.35
700	0.857	-137.14	1.432	87.95	0.097	19.29	0.798	-32.27
800	0.850	-144.21	1.289	81.60	0.095	17.58	0.796	-35.02
900	0.845	-150.72	1.176	76.29	0.090	17.23	0.797	-38.01
1000	0.839	-156.10	1.081	70.99	0.085	16.55	0.797	-41.02

$V_{CE}=5V, I_C=3mA, Z_O=50\Omega$

Freq(MHz)	S11	$\angle S11$	S21	$\angle S21$	S12	$\angle S12$	S22	$\angle S22$
100	0.892	-58.77	8.161	145.03	0.034	56.36	0.902	-14.46
200	0.843	-98.07	6.099	122.67	0.051	42.43	0.786	-20.13
300	0.817	-121.82	4.658	108.72	0.055	33.87	0.727	-22.56
400	0.803	-136.85	3.715	98.70	0.058	30.68	0.700	-24.99
500	0.792	-146.48	3.051	91.64	0.058	28.74	0.687	-26.83
600	0.786	-154.00	2.599	85.58	0.058	29.60	0.678	-29.37
700	0.788	-159.54	2.257	80.45	0.056	31.43	0.677	-32.02
800	0.787	-164.23	2.001	75.47	0.055	35.06	0.680	-34.73
900	0.784	-168.41	1.798	71.27	0.054	40.40	0.683	-37.51
1000	0.782	-171.95	1.635	67.12	0.056	43.46	0.687	-40.32

$V_{CE}=5V, I_C=5mA, Z_O=50\Omega$

Freq(MHz)	S11	$\angle S11$	S21	$\angle S21$	S12	$\angle S12$	S22	$\angle S22$
100	0.836	-76.63	11.501	136.45	0.030	52.40	0.838	-17.51
200	0.798	-117.27	7.726	114.17	0.040	37.48	0.709	-21.18
300	0.781	-137.77	5.593	101.72	0.043	34.01	0.658	-22.46
400	0.773	-149.33	4.358	93.38	0.044	33.11	0.638	-24.37
500	0.769	-156.90	3.532	87.35	0.046	36.56	0.630	-26.09
600	0.766	-162.43	2.982	81.95	0.045	39.81	0.625	-28.60
700	0.769	-167.07	2.577	77.34	0.045	42.61	0.624	-31.24
800	0.770	-170.74	2.274	72.95	0.048	47.50	0.632	-33.83
900	0.768	-173.91	2.041	69.14	0.049	53.32	0.637	-36.62
1000	0.765	-176.92	1.844	65.26	0.054	58.93	0.643	-39.47

$V_{CE}=5V, I_C=10mA, Z_O=50\Omega$

Freq(MHz)	S11	$\angle S11$	S21	$\angle S21$	S12	$\angle S12$	S22	$\angle S22$
100	0.767	-103.15	15.822	124.63	0.023	46.33	0.734	-20.47
200	0.755	-138.50	9.411	104.65	0.028	38.32	0.619	-20.77
300	0.754	-153.35	6.527	94.69	0.030	38.73	0.584	-21.03
400	0.752	-161.57	4.982	87.97	0.033	42.64	0.572	-22.78
500	0.750	-166.80	4.014	82.84	0.035	48.31	0.572	-24.69
600	0.748	-170.55	3.373	78.22	0.037	54.47	0.569	-27.25
700	0.753	-173.80	2.897	73.96	0.041	59.86	0.572	-29.68
800	0.756	-176.67	2.549	69.82	0.044	62.98	0.581	-32.50
900	0.757	-179.14	2.277	66.41	0.049	68.43	0.588	-35.36
1000	0.755	-178.64	2.056	62.61	0.053	72.29	0.593	-38.13

# 15GN03FA

## S Parameters (Common emitter)

$V_{CE}=5V, I_C=15mA, Z_O=50\Omega$

Freq(MHz)	S11	$\angle S11$	S21	$\angle S21$	S12	$\angle S12$	S22	$\angle S22$
100	0.738	-117.62	17.843	118.37	0.020	37.24	0.676	-21.03
200	0.743	-147.93	10.060	100.54	0.023	37.86	0.576	-19.90
300	0.747	-159.66	6.883	91.63	0.025	46.10	0.554	-19.99
400	0.745	-166.45	5.220	85.36	0.029	50.71	0.546	-21.67
500	0.744	-170.73	4.196	80.63	0.032	56.16	0.545	-23.38
600	0.745	-173.77	3.511	76.05	0.037	61.92	0.546	-26.19
700	0.752	-176.53	3.020	72.07	0.040	66.25	0.552	-28.81
800	0.756	-179.03	2.658	68.01	0.044	70.92	0.560	-31.80
900	0.755	178.79	2.361	64.63	0.049	74.88	0.565	-34.57
1000	0.756	176.76	2.132	60.89	0.053	76.28	0.574	-37.19

$V_{CE}=5V, I_C=20mA, Z_O=50\Omega$

Freq(MHz)	S11	$\angle S11$	S21	$\angle S21$	S12	$\angle S12$	S22	$\angle S22$
100	0.726	-126.53	18.861	114.70	0.017	40.89	0.640	-21.11
200	0.739	-153.13	10.358	98.19	0.022	42.84	0.553	-18.93
300	0.745	-163.18	7.042	89.82	0.024	49.20	0.536	-19.14
400	0.745	-169.08	5.324	83.86	0.027	55.62	0.530	-20.71
500	0.745	-172.83	4.271	79.22	0.031	60.79	0.533	-22.65
600	0.746	-175.56	3.573	74.72	0.035	67.12	0.534	-25.56
700	0.753	-177.99	3.062	70.86	0.039	71.29	0.539	-28.07
800	0.756	179.89	2.695	66.61	0.043	73.72	0.550	-30.95
900	0.757	177.73	2.394	63.36	0.050	76.38	0.557	-33.79
1000	0.758	175.84	2.152	59.54	0.055	80.04	0.565	-36.64

$V_{CE}=5V, I_C=30mA, Z_O=50\Omega$

Freq(MHz)	S11	$\angle S11$	S21	$\angle S21$	S12	$\angle S12$	S22	$\angle S22$
100	0.717	-137.48	19.630	110.26	0.015	44.21	0.601	-20.34
200	0.738	-159.18	10.491	95.35	0.018	47.49	0.531	-17.41
300	0.746	-167.18	7.088	87.53	0.021	53.11	0.517	-17.66
400	0.748	-172.07	5.346	81.72	0.026	61.37	0.517	-19.37
500	0.748	-175.06	4.275	77.20	0.030	66.16	0.521	-21.62
600	0.752	-177.32	3.568	72.74	0.034	71.42	0.527	-24.47
700	0.760	-179.44	3.054	68.73	0.039	73.32	0.532	-26.91
800	0.764	178.51	2.662	64.73	0.044	78.79	0.543	-29.78
900	0.766	176.85	2.365	61.05	0.049	79.65	0.553	-32.93
1000	0.766	174.89	2.129	57.53	0.055	81.62	0.562	-35.85

$V_{CE}=5V, I_C=50mA, Z_O=50\Omega$

Freq(MHz)	S11	$\angle S11$	S21	$\angle S21$	S12	$\angle S12$	S22	$\angle S22$
100	0.726	-148.90	18.826	105.46	0.013	44.77	0.567	-18.27
200	0.751	-165.14	9.843	92.00	0.017	52.99	0.521	-15.19
300	0.762	-171.12	6.595	84.51	0.020	59.41	0.513	-16.09
400	0.764	-174.96	4.946	78.62	0.024	66.61	0.516	-18.39
500	0.767	-177.43	3.935	74.00	0.029	73.69	0.522	-20.54
600	0.772	-179.26	3.268	69.60	0.033	75.14	0.529	-23.65
700	0.780	178.77	2.784	65.39	0.038	78.53	0.537	-26.50
800	0.786	176.95	2.430	60.89	0.043	80.73	0.548	-29.67
900	0.789	175.17	2.150	57.73	0.050	83.79	0.559	-32.92
1000	0.791	173.32	1.926	53.98	0.054	84.92	0.569	-35.99

# 15GN03FA

## Embossed Taping Specification

15GN03FA-TL-H

### 1. Packing Format

Package Name	Carrier Tape Type	Maximum Number of devices contained (pcs)			Packing format	
		Reel	Inner box	Outer box	Inner BOX (C-1)	Outer BOX (A-7)
SSFP	SSFP	8,000	40,000	240,000	5 reels contained Dimensions:mm (external) 183×72×185	6 inner boxes contained Dimensions:mm (external) 440×195×210

#### Packing method

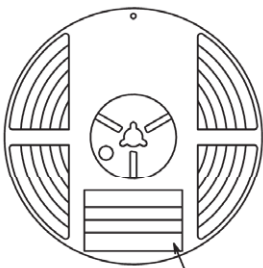

Reel label

Reel label, Inner box label  
(unit:mm)

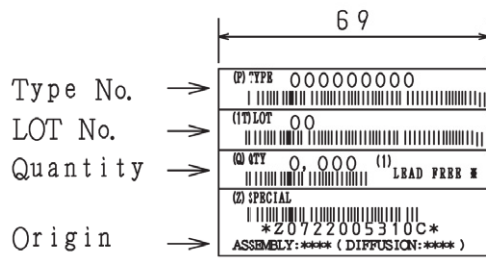

Outer box label

It is a label at the time of factory shipments. The form of a label may change in physical distribution process.

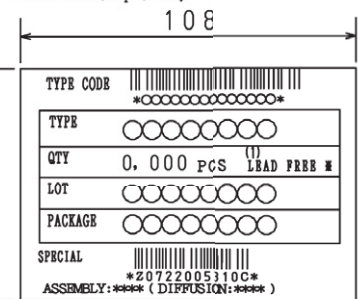

#### NOTE (1)

The LEAD FREE \* description shows that the surface treatment of the terminal is lead free.

Label	JEITA Phase
LEAD FREE 3	JEITA Phase 3A
LEAD FREE 4	JEITA Phase 3

### 2. Taping configuration

#### 2-1. Carrier tape size (unit:mm)

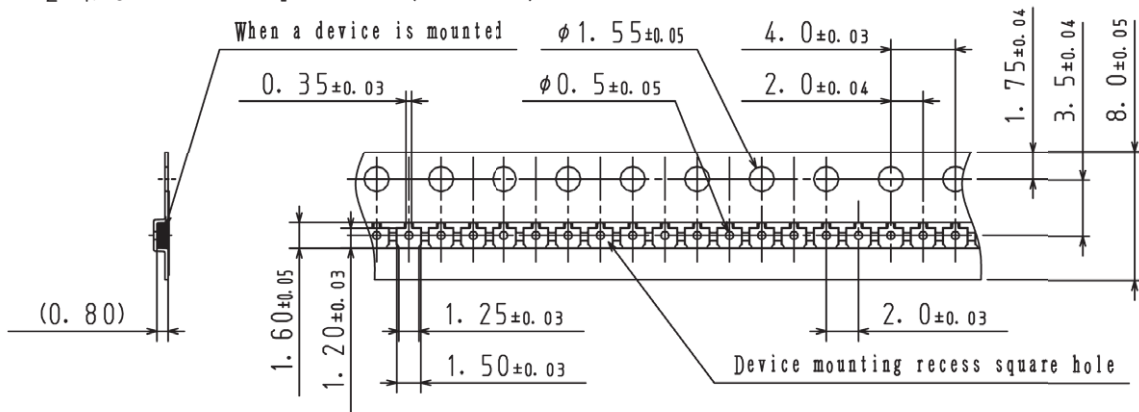

#### 2-2. Device placement direction

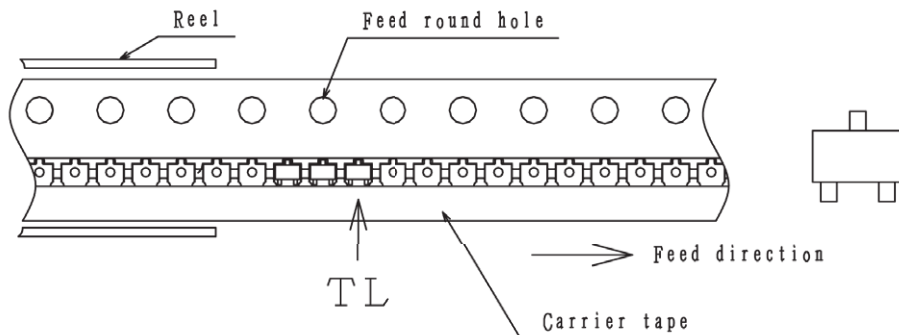

Those with pin 1 index on the feed hole side.....TL

# 15GN03FA

## Outline Drawing

15GN03FA-TL-H

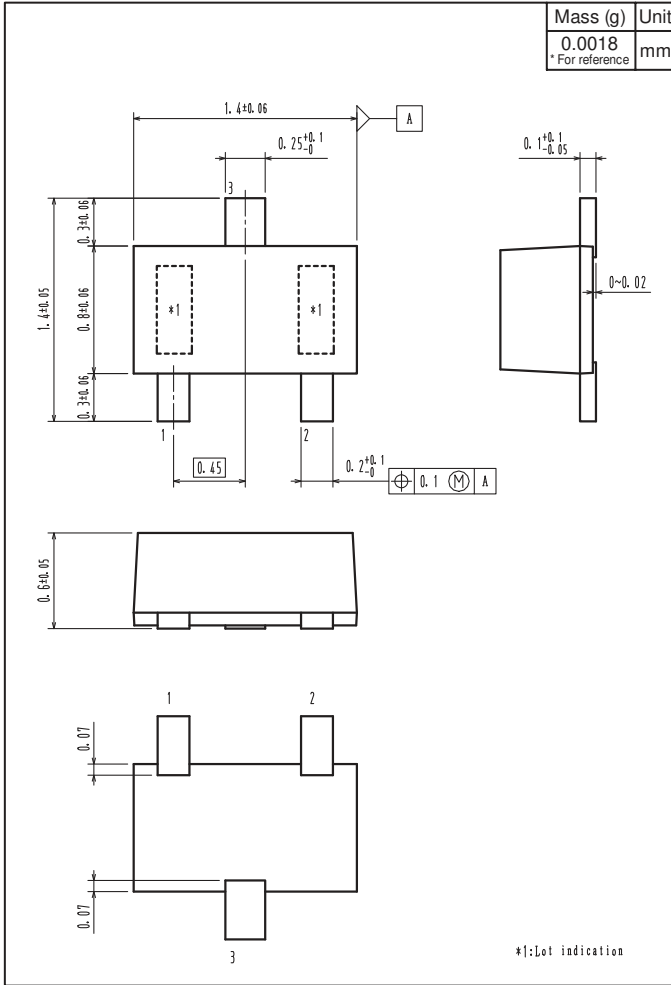

## Land Pattern Example

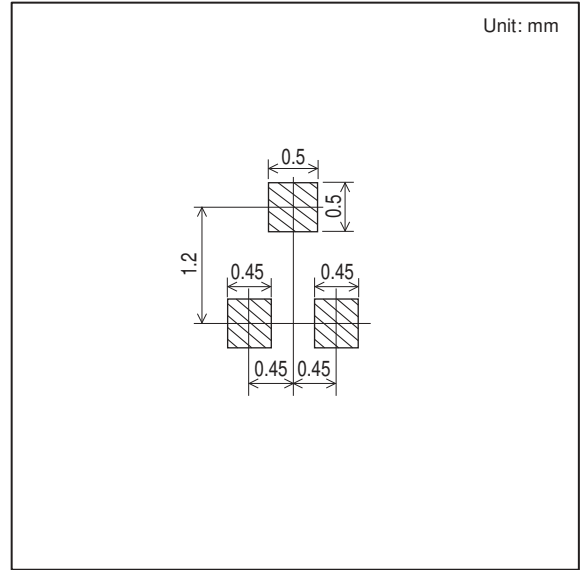

ON Semiconductor and the ON logo are registered trademarks of Semiconductor Components Industries, LLC (SCILLC). SCILLC owns the rights to a number of patents, trademarks, copyrights, trade secrets, and other intellectual property. A listing of SCILLC's product/patent coverage may be accessed at [www.onsemi.com/site/pdf/Patent-Marking.pdf](http://www.onsemi.com/site/pdf/Patent-Marking.pdf). SCILLC reserves the right to make changes without further notice to any products herein. SCILLC makes no warranty, representation or guarantee regarding the suitability of its products for any particular purpose, nor does SCILLC assume any liability arising out of the application or use of any product or circuit, and specifically disclaims any and all liability, including without limitation special, consequential or incidental damages. "Typical" parameters which may be provided in SCILLC data sheets and/or specifications can and do vary in different applications and actual performance may vary over time. All operating parameters, including "Typicals" must be validated for each customer application by customer's technical experts. SCILLC does not convey any license under its patent rights nor the rights of others. SCILLC products are not designed, intended, or authorized for use as components in systems intended for surgical implant into the body, or other applications intended to support or sustain life, or for any other application in which the failure of the SCILLC product could create a situation where personal injury or death may occur. Should Buyer purchase or use SCILLC products for any such unintended or unauthorized application, Buyer shall indemnify and hold SCILLC and its officers, employees, subsidiaries, affiliates, and distributors harmless against all claims, costs, damages, and expenses, and reasonable attorney fees arising out of, directly or indirectly, any claim of personal injury or death associated with such unintended or unauthorized use, even if such claim alleges that SCILLC was negligent regarding the design or manufacture of the part. SCILLC is an Equal Opportunity/Affirmative Action Employer. This literature is subject to all applicable copyright laws and is not for resale in any manner.