



Improved Precision Micropower Shunt Voltage Reference with Multiple Reverse Breakdown Voltages

General Description

The LM4040 is a precision two-terminal shunt mode, bandgap voltage reference available in fixed reverse breakdown voltages of 2.048V, 2.500V, 3.000V, 3.3V, 4.096V, and 5.000V. Ideal for space-critical applications, the LM4040 is offered in the subminiature 3-pin SC70 surface-mount package (1.8mm × 1.8mm), 50% smaller than comparable devices in SOT23 surface-mount packages (SOT23 versions are also available).

Laser-trimmed resistors ensure precise initial accuracy. With a 100ppm/°C temperature coefficient, the device is offered in four grades of initial accuracy ranging from 0.1% to 1%. The LM4040 has a 60μA to 15mA shunt current capability with low dynamic impedance, ensuring stable reverse breakdown voltage accuracy over a wide range of operating temperatures and currents.

The LM4040 does not require an external stabilizing capacitor while ensuring stability with any capacitive load.

The LM4040 is guaranteed over the temperature range of -40°C to +125°C.

For a 1.225V output version, refer to the LM4041 data sheet.

Applications

Portable, Battery-Powered Equipment
 Notebook Computers
 Cell Phones
 Industrial Process Controls

Pin Configuration

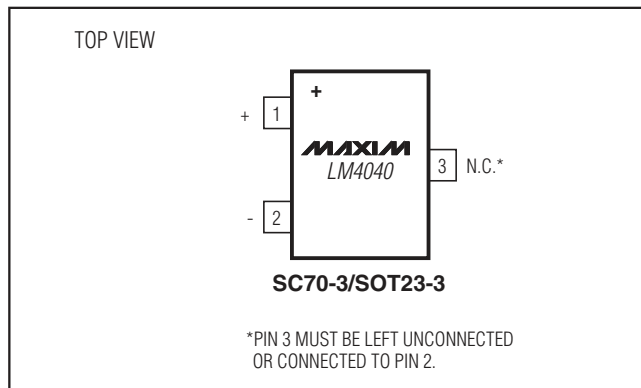

Features

- ◆ Ultra-Small 3-Pin SC70 Package
- ◆ 0.1% (max) Initial Accuracy
- ◆ 100ppm/°C (max) Temperature Coefficient Guaranteed over -40°C to +125°C Temperature Range
- ◆ Wide Operating Current Range: 60μA to 15mA
- ◆ Low 28μVRMS Output Noise (10Hz to 10kHz)
- ◆ 2.048V, 2.500V, 3.000V, 3.3V, 4.096V, and 5.000V Fixed Reverse Breakdown Voltages
- ◆ No Output Capacitors Required
- ◆ Tolerates Capacitive Loads

Selector Guide

PART	TEMP RANGE	PIN-PACKAGE	OUTPUT VOLTAGE (V)
LM4040_IM3-2.1+T	-40°C to +85°C	3 SOT23	2.048
LM4040_IX3-2.1+T	-40°C to +85°C	3 SC70	2.048
LM4040_EM3-2.1+T	-40°C to +125°C	3 SOT23	2.048
LM4040_EX3-2.1+T	-40°C to +125°C	3 SC70	2.048
LM4040_IM3-2.5+T	-40°C to +85°C	3 SOT23	2.500
LM4040_IX3-2.5+T	-40°C to +85°C	3 SC70	2.500
LM4040_IM3-2.5V+T	-40°C to +85°C	3 SC70	2.500
LM4040_EM3-2.5+T	-40°C to +125°C	3 SOT23	2.500
LM4040_EM3-2.5V+T	-40°C to +125°C	3 SOT23	2.500
LM4040_EX3-2.5+T	-40°C to +125°C	3 SC70	2.500
LM4040_IM3-3.0+T	-40°C to +85°C	3 SOT23	3.000
LM4040_IX3-3.0+T	-40°C to +85°C	3 SC70	3.000
LM4040_EX3-3.0+T	-40°C to +125°C	3 SC70	3.000
LM4040_EX3-3.3+T	-40°C to +125°C	3 SC70	3.300
LM4040_IM3-4.1+T	-40°C to +85°C	3 SOT23	4.096
LM4040_IX3-4.1+T	-40°C to +85°C	3 SC70	4.096
LM4040_EM3-4.1	-40°C to +125°C	3 SOT23	4.096
LM4040_EM3-4.1V+T	-40°C to +125°C	3 SOT23	4.096
LM4040_EX3-4.1+T	-40°C to +125°C	3 SC70	4.096
LM4040_IM3-5.0+T	-40°C to +85°C	3 SOT23	5.000
LM4040_IX3-5.0+T	-40°C to +85°C	3 SC70	5.000
LM4040_EM3-5.0+T	-40°C to +125°C	3 SOT23	5.000
LM4040_EM3-5.0V+T	-40°C to +125°C	3 SOT23	5.000
LM4040_EX3-5.0+T	-40°C to +125°C	3 SC70	5.000

+ Denotes a lead(Pb)-free/RoHS-compliant package.
 T = Tape and reel.

Ordering Information appears at end of data sheet.



Improved Precision Micropower Shunt Voltage Reference with Multiple Reverse Breakdown Voltages

ABSOLUTE MAXIMUM RATINGS

Reverse Current (cathode to anode)20mA
 Forward Current (anode to cathode) 10mA
 Continuous Power Dissipation (T_A = +70°C)
 3-Pin SC70 (derate 2.17mW/°C above +70°C)174mW
 3-Pin SOT23 (derate 4.01mW/°C above +70°C)320mW

Operating Temperature Range

LM4040_I_ _-40°C to +85°C
 LM4040_E_ _-40°C to +125°C
 Storage Temperature Range-65°C to +150°C
 Junction Temperature+150°C
 Lead Temperature (soldering, 10s)+300°C
 Soldering Temperature (reflow)+260°C

Stresses beyond those listed under "Absolute Maximum Ratings" may cause permanent damage to the device. These are stress ratings only, and functional operation of the device at these or any other conditions beyond those indicated in the operational sections of the specifications is not implied. Exposure to absolute maximum rating conditions for extended periods may affect device reliability.

ELECTRICAL CHARACTERISTICS—2.048V

(I_R = 100μA, T_A = T_{MIN} to T_{MAX}, unless otherwise noted. Typical values are at T_A = +25°C.) (Note 1)

PARAMETER	SYMBOL	CONDITIONS		MIN	TYP	MAX	UNITS
Reverse Breakdown Voltage	V _R	T _A = +25°C	LM4040A (0.1%)	2.046	2.048	2.050	V
			LM4040B (0.2%)	2.044	2.048	2.052	
			LM4040C (0.5%)	2.038	2.048	2.058	
			LM4040D (1.0%)	2.028	2.048	2.068	
Reverse Breakdown Voltage Tolerance (Note 2)	V _R	LM4040A		±2.0	±15	mV	
		LM4040B		±4.0	±17		
		LM4040C		±10	±23		
		LM4040D		±20	±41		
Minimum Operating Current	I _{RMIN}	LM4040A/B/C		45	65	μA	
		LM4040D		45	70		
Average Reverse Voltage Temperature Coefficient (Notes 2 and 3)	ΔV _R /ΔT	I _R = 10mA		±20		ppm/°C	
		I _R = 1mA	LM4040A/B/C	±15	±100		
			LM4040D	±15	±150		
I _R = 100μA		±15					
Reverse Breakdown Voltage Change with Operating Current Change		I _{RMIN} ≤ I _R ≤ 1mA	LM4040A/B/C		0.3	1.0	mV
			LM4040D		0.3	1.2	
		1mA ≤ I _R ≤ 15mA	LM4040A/B/C		2.5	8.0	
			LM4040D		2.5	10.0	
Reverse Dynamic Impedance (Note 3)	Z _R	I _R = 1mA, f = 120Hz, I _{AC} = 0.1I _R	LM4040A/B		0.3	0.8	Ω
			LM4040C		0.3	0.9	
			LM4040D		0.3	1.1	
Wideband Noise	e _N	I _R = 100μA, 10Hz ≤ f ≤ 10kHz		28		μV _{RMS}	
Reverse Breakdown Voltage Long-Term Stability	ΔV _R	T = 1000h		120		ppm	

Improved Precision Micropower Shunt Voltage Reference with Multiple Reverse Breakdown Voltages

LM4040

ELECTRICAL CHARACTERISTICS—2.500V

($I_R = 100\mu\text{A}$, $T_A = T_{\text{MIN}}$ to T_{MAX} , unless otherwise noted. Typical values are at $T_A = +25^\circ\text{C}$.) (Note 1)

PARAMETER	SYMBOL	CONDITIONS		MIN	TYP	MAX	UNITS
Reverse Breakdown Voltage	V_R	$T_A = +25^\circ\text{C}$	LM4040A (0.1%)	2.4975	2.5000	2.5025	V
			LM4040B (0.2%)	2.4950	2.5000	2.5050	
			LM4040C (0.5%)	2.4875	2.5000	2.5125	
			LM4040D (1.0%)	2.4750	2.5000	2.5250	
Reverse Breakdown Voltage Tolerance (Note 2)	V_R	LM4040A		± 2.0	± 19	mV	
		LM4040B		± 4.0	± 21		
		LM4040C		± 10	± 29		
		LM4040D		± 20	± 49		
Minimum Operating Current	$I_{R\text{MIN}}$	LM4040A/B/C		45	65	μA	
		LM4040D		45	70		
Average Reverse Voltage Temperature Coefficient (Notes 2 and 3)	$\Delta V_R/\Delta T$	$I_R = 10\text{mA}$		± 20		ppm/ $^\circ\text{C}$	
		$I_R = 1\text{mA}$	LM4040A/B/C	± 15	± 100		
			LM4040D	± 15	± 150		
Reverse Breakdown Voltage Change with Operating Current Change		$I_{R\text{MIN}} \leq I_R \leq 1\text{mA}$	LM4040A/B/C	0.3	1.0	mV	
			LM4040D	0.4	1.2		
		$1\text{mA} \leq I_R \leq 15\text{mA}$	LM4040A/B/C	2.5	8.0		
			LM4040D	2.5	10.0		
Reverse Dynamic Impedance (Note 3)	Z_R	$I_R = 1\text{mA}$, $f = 120\text{Hz}$, $I_{\text{AC}} = 0.1I_R$	LM4040A/B	0.3	0.8	Ω	
			LM4040C	0.3	0.9		
			LM4040D	0.3	1.1		
Wideband Noise	e_N	$I_R = 100\mu\text{A}$, $10\text{Hz} \leq f \leq 10\text{kHz}$		35		μVRMS	
Reverse Breakdown Voltage Long-Term Stability	ΔV_R	$T = 1000\text{h}$		120		ppm	

Improved Precision Micropower Shunt Voltage Reference with Multiple Reverse Breakdown Voltages

LM4040

ELECTRICAL CHARACTERISTICS—3.000V

($I_R = 100\mu\text{A}$, $T_A = T_{\text{MIN}}$ to T_{MAX} , unless otherwise noted. Typical values are at $T_A = +25^\circ\text{C}$.) (Note 1)

PARAMETER	SYMBOL	CONDITIONS		MIN	TYP	MAX	UNITS
Reverse Breakdown Voltage	V_R	$T_A = +25^\circ\text{C}$	LM4040A (0.1%)	2.997	3.000	3.003	V
			LM4040B (0.2%)	2.994	3.000	3.006	
			LM4040C (0.5%)	2.985	3.000	3.015	
			LM4040D (1.0%)	2.970	3.000	3.030	
Reverse Breakdown Voltage Tolerance (Note 2)	V_R	LM4040A		± 3.0	± 22	mV	
		LM4040B		± 6.0	± 26		
		LM4040C		± 15	± 34		
		LM4040D		± 30	± 59		
Minimum Operating Current	$I_{R\text{MIN}}$	LM4040A/B/C		45	67	μA	
		LM4040D		45	70		
Average Reverse Voltage Temperature Coefficient (Notes 2 and 3)	$\Delta V_R/\Delta T$	$I_R = 10\text{mA}$		± 20		ppm/ $^\circ\text{C}$	
		$I_R = 1\text{mA}$	LM4040A/B/C	± 15	± 100		
			LM4040D	± 15	± 150		
Reverse Breakdown Voltage Change with Operating Current Change		$I_{R\text{MIN}} \leq I_R \leq 1\text{mA}$	LM4040A/B/C		0.3	1.0	mV
			LM4040D		0.3	1.2	
		$1\text{mA} \leq I_R \leq 15\text{mA}$	LM4040A/B/C		2.5	8.0	
			LM4040D		2.5	10.0	
Reverse Dynamic Impedance (Note 3)	Z_R	$I_R = 1\text{mA}$, $f = 120\text{Hz}$, $I_{\text{AC}} = 0.1I_R$	LM4040A/B		0.3	0.8	Ω
			LM4040C		0.3	0.9	
			LM4040D		0.3	1.1	
Wideband Noise	e_N	$I_R = 100\mu\text{A}$, $10\text{Hz} \leq f \leq 10\text{kHz}$		45		μVRMS	
Reverse Breakdown Voltage Long-Term Stability	ΔV_R	$T = 1000\text{h}$		120		ppm	

Improved Precision Micropower Shunt Voltage Reference with Multiple Reverse Breakdown Voltages

LM4040

ELECTRICAL CHARACTERISTICS—3.300V

($I_R = 100\mu\text{A}$, $T_A = T_{\text{MIN}}$ to T_{MAX} , unless otherwise noted. Typical values are at $T_A = +25^\circ\text{C}$.) (Note 1)

PARAMETER	SYMBOL	CONDITIONS		MIN	TYP	MAX	UNITS
Reverse Breakdown Voltage	V_R	$T_A = +25^\circ\text{C}$	LM4040A (0.1%)	3.2967	3.3000	3.3033	V
			LM4040B (0.2%)	3.2934	3.3000	3.3066	
			LM4040C (0.5%)	3.2835	3.3000	3.3165	
			LM4040D (1.0%)	3.2670	3.3000	3.3330	
Reverse Breakdown Voltage Tolerance (Note 2)	V_R	LM4040A		± 3.0	± 22	mV	
		LM4040B		± 6.0	± 26		
		LM4040C		± 15	± 34		
		LM4040D		± 30	± 59		
Minimum Operating Current	$I_{R\text{MIN}}$	LM4040A/B/C		45	67	μA	
		LM4040D		45	70		
Average Reverse Voltage Temperature Coefficient (Notes 2 and 3)	$\Delta V_R/\Delta T$	$I_R = 10\text{mA}$		± 20		ppm/ $^\circ\text{C}$	
		$I_R = 1\text{mA}$	LM4040A/B/C	± 15	± 100		
			LM4040D	± 15	± 150		
Reverse Breakdown Voltage Change with Operating Current Change		$I_{R\text{MIN}} \leq I_R \leq 1\text{mA}$	LM4040A/B/C	0.3	1.0	mV	
			LM4040D	0.3	1.2		
		$1\text{mA} \leq I_R \leq 15\text{mA}$	LM4040A/B/C	2.5	8.0		
			LM4040D	2.5	10.0		
Reverse Dynamic Impedance (Note 3)	Z_R	$I_R = 1\text{mA}$, $f = 120\text{Hz}$, $I_{\text{AC}} = 0.1I_R$	LM4040A/B	0.3	0.8	Ω	
			LM4040C	0.3	0.9		
			LM4040D	0.3	1.1		
Wideband Noise	e_N	$I_R = 100\mu\text{A}$, $10\text{Hz} \leq f \leq 10\text{kHz}$		50		μVRMS	
Reverse Breakdown Voltage Long-Term Stability	ΔV_R	$T = 1000\text{h}$		120		ppm	

Improved Precision Micropower Shunt Voltage Reference with Multiple Reverse Breakdown Voltages

LM4040

ELECTRICAL CHARACTERISTICS—4.096V

($I_R = 100\mu\text{A}$, $T_A = T_{\text{MIN}}$ to T_{MAX} , unless otherwise noted. Typical values are at $T_A = +25^\circ\text{C}$.) (Note 1)

PARAMETER	SYMBOL	CONDITIONS		MIN	TYP	MAX	UNITS
Reverse Breakdown Voltage	V_R	$T_A = +25^\circ\text{C}$	LM4040A (0.1%)	4.092	4.096	4.100	V
			LM4040B (0.2%)	4.088	4.096	4.104	
			LM4040C (0.5%)	4.076	4.096	4.116	
			LM4040D (1.0%)	4.055	4.096	4.137	
Reverse Breakdown Voltage Tolerance (Note 2)	V_R	LM4040A		± 4.1	± 31	mV	
		LM4040B		± 8.2	± 35		
		LM4040C		± 20	± 47		
		LM4040D		± 41	± 81		
Minimum Operating Current	$I_{R\text{MIN}}$	LM4040A/B/C		50	73	μA	
		LM4040D		50	78		
Average Reverse Voltage Temperature Coefficient (Notes 2 and 3)	$\Delta V_R/\Delta T$	$I_R = 10\text{mA}$		± 30		ppm/ $^\circ\text{C}$	
		$I_R = 1\text{mA}$	LM4040A/B/C	± 20	± 100		
			LM4040D	± 20	± 150		
$I_R = 100\mu\text{A}$		± 15					
Reverse Breakdown Voltage Change with Operating Current Change		$I_{R\text{MIN}} \leq I_R \leq 1\text{mA}$	LM4040A/B/C	0.5	1.2	mV	
			LM4040D	0.5	1.5		
		$1\text{mA} \leq I_R \leq 15\text{mA}$	LM4040A/B/C	3.0	10.0		
			LM4040D	3.0	13.0		
Reverse Dynamic Impedance (Note 3)	Z_R	$I_R = 1\text{mA}$, $f = 120\text{Hz}$, $I_{\text{AC}} = 0.1I_R$	LM4040A/B/C	0.5	1.0	Ω	
			LM4040D	0.5	1.3		
Wideband Noise	e_N	$I_R = 100\mu\text{A}$, $10\text{Hz} \leq f \leq 10\text{kHz}$		64		μV_{RMS}	
Reverse Breakdown Voltage Long-Term Stability	ΔV_R	$T = 1000\text{h}$		120		ppm	

Improved Precision Micropower Shunt Voltage Reference with Multiple Reverse Breakdown Voltages

LM4040

ELECTRICAL CHARACTERISTICS—5.000V

($I_R = 100\mu\text{A}$, $T_A = T_{\text{MIN}}$ to T_{MAX} , unless otherwise noted. Typical values are at $T_A = +25^\circ\text{C}$.) (Note 1)

PARAMETER	SYMBOL	CONDITIONS		MIN	TYP	MAX	UNITS
Reverse Breakdown Voltage	V_R	$T_A = +25^\circ\text{C}$	LM4040A (0.1%)	4.995	5.000	5.005	V
			LM4040B (0.2%)	4.990	5.000	5.010	
			LM4040C (0.5%)	4.975	5.000	5.025	
			LM4040D (1.0%)	4.950	5.000	5.050	
Reverse Breakdown Voltage Tolerance (Note 2)	V_R	LM4040A		± 5.0	± 38	mV	
		LM4040B		± 10	± 43		
		LM4040C		± 25	± 58		
		LM4040D		± 50	± 99		
Minimum Operating Current	$I_{R\text{MIN}}$	LM4040A/B/C		54	80	μA	
		LM4040D		54	85		
Average Reverse Voltage Temperature Coefficient (Notes 2 and 3)	$\Delta V_R/\Delta T$	$I_R = 10\text{mA}$		± 30		ppm/ $^\circ\text{C}$	
		$I_R = 1\text{mA}$	LM4040A/B/C	± 20	± 100		
			LM4040D	± 20	± 150		
Reverse Breakdown Voltage Change with Operating Current Change		$I_{R\text{MIN}} \leq I_R \leq 1\text{mA}$	LM4040A/B/C	0.5	1.4	mV	
			LM4040D	0.5	1.8		
		$1\text{mA} \leq I_R \leq 15\text{mA}$	LM4040A/B/C	3.5	12.0		
			LM4040D	3.5	15.0		
Reverse Dynamic Impedance (Note 3)	Z_R	$I_R = 1\text{mA}$, $f = 120\text{Hz}$, $I_{AC} = 0.1I_R$	LM4040A/B/C	0.5	1.1	Ω	
			LM4040D	0.5	1.5		
Wideband Noise	e_N	$I_R = 100\mu\text{A}$, $10\text{Hz} \leq f \leq 10\text{kHz}$		80		μV_{RMS}	
Reverse Breakdown Voltage Long-Term Stability	ΔV_R	$T = 1000\text{h}$		120		ppm	

Note 1: All devices are 100% production tested at $T_A = +25^\circ\text{C}$ and are guaranteed by design for $T_A = T_{\text{MIN}}$ to T_{MAX} , as specified.

Note 2: The overtemperature limit for Reverse Breakdown Voltage Tolerance is defined as the room-temperature Reverse Breakdown Voltage Tolerance $\pm[(\Delta V_R/\Delta T)(\text{max}\Delta T)(V_R)]$, where $\Delta V_R/\Delta T$ is the V_R temperature coefficient, $\text{max}\Delta T$ is the maximum difference in temperature from the reference point of $+25^\circ\text{C}$ to T_{MIN} or T_{MAX} , and V_R is the reverse breakdown voltage. The total overtemperature tolerance for the different grades in the temperature range where $\text{max}\Delta T = +65^\circ\text{C}$ is shown below:

A grade: $\pm 0.75\% = \pm 0.1\% \pm 100\text{ppm}/^\circ\text{C} \times 65^\circ\text{C}$

B grade: $\pm 0.85\% = \pm 0.2\% \pm 100\text{ppm}/^\circ\text{C} \times 65^\circ\text{C}$

C grade: $\pm 1.15\% = \pm 0.5\% \pm 100\text{ppm}/^\circ\text{C} \times 65^\circ\text{C}$

D grade: $\pm 1.98\% = \pm 1.0\% \pm 150\text{ppm}/^\circ\text{C} \times 65^\circ\text{C}$

The total over-temperature tolerance for the different grades in the extended temperature range where $\text{max}\Delta T = +100^\circ\text{C}$ is shown below:

A grade: $\pm 1.1\% = \pm 0.1\% \pm 100\text{ppm}/^\circ\text{C} \times 100^\circ\text{C}$

B grade: $\pm 1.2\% = \pm 0.2\% \pm 100\text{ppm}/^\circ\text{C} \times 100^\circ\text{C}$

C grade: $\pm 1.5\% = \pm 0.5\% \pm 100\text{ppm}/^\circ\text{C} \times 100^\circ\text{C}$

D grade: $\pm 2.5\% = \pm 1.0\% \pm 150\text{ppm}/^\circ\text{C} \times 100^\circ\text{C}$

Therefore, as an example, the A-grade LM4040-2.5 has an over-temperature reverse breakdown voltage tolerance of $\pm 2.5\text{V} \times 0.75\% = \pm 19\text{mV}$.

Note 3: Guaranteed by design.

Improved Precision Micropower Shunt Voltage Reference with Multiple Reverse Breakdown Voltages

Typical Operating Characteristics

($I_R = 100\mu A$, SC70-3 package, $T_A = +25^\circ C$, unless otherwise noted.)

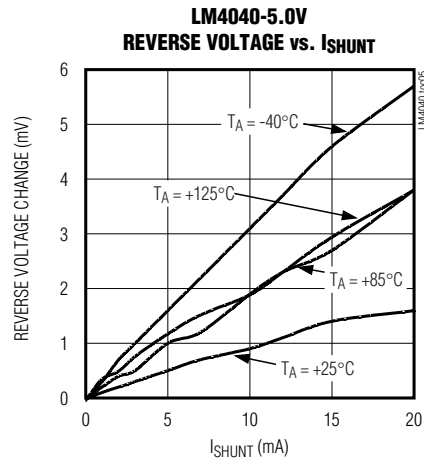
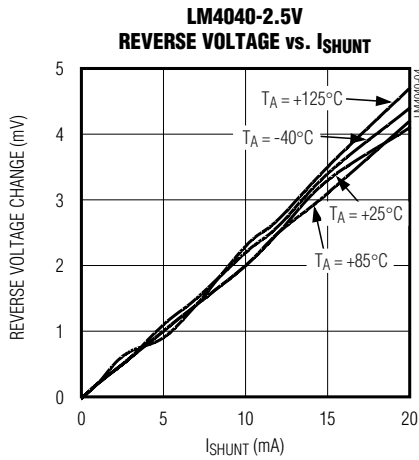
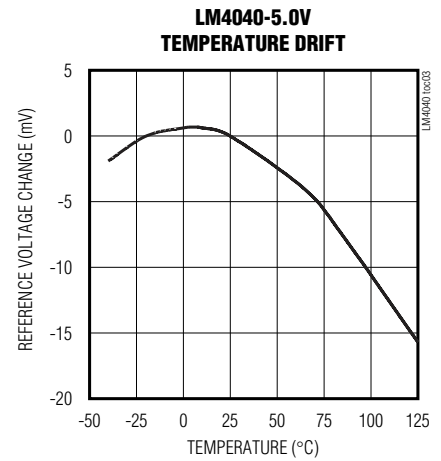
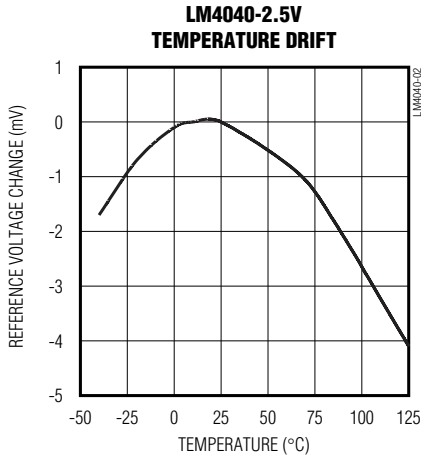
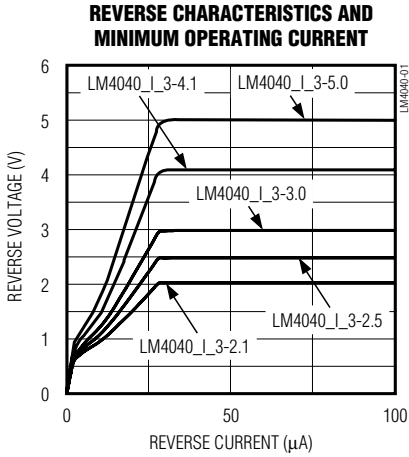

Improved Precision Micropower Shunt Voltage Reference with Multiple Reverse Breakdown Voltages

Typical Operating Characteristics (continued)

($I_R = 100\mu\text{A}$, SC70 package, $T_A = +25^\circ\text{C}$, unless otherwise noted.)

LM4040

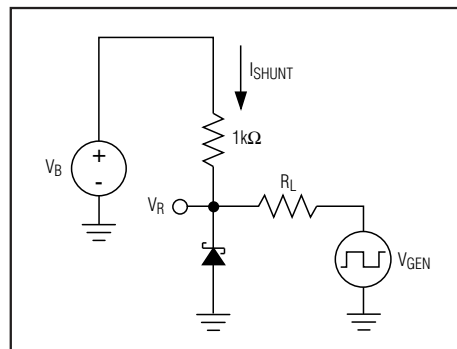
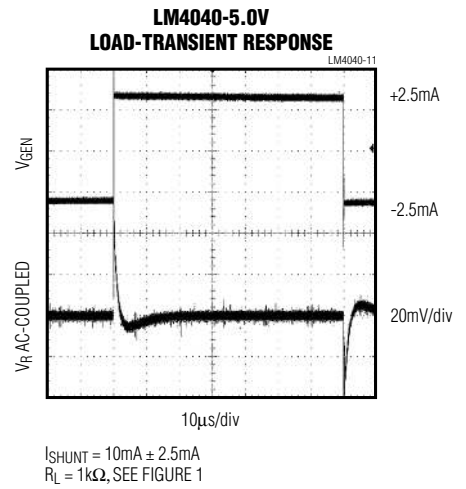
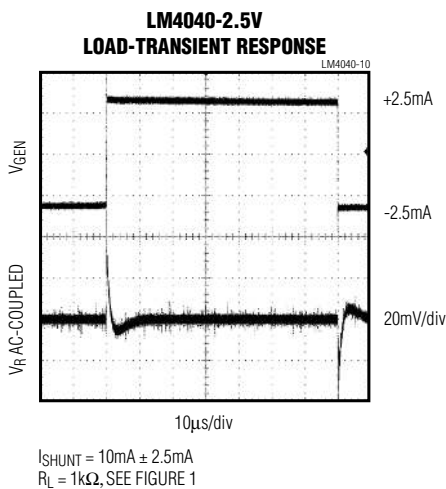
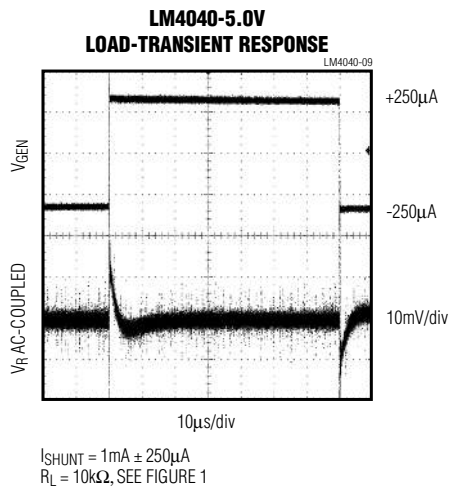
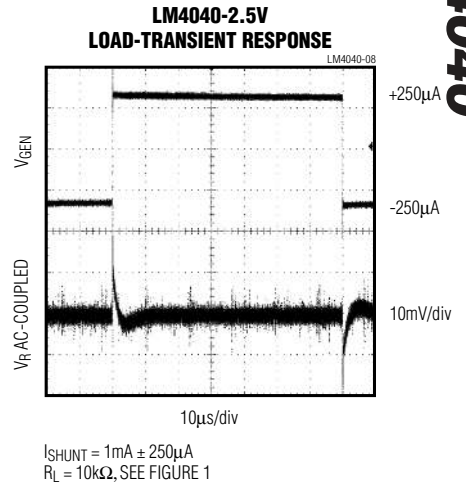
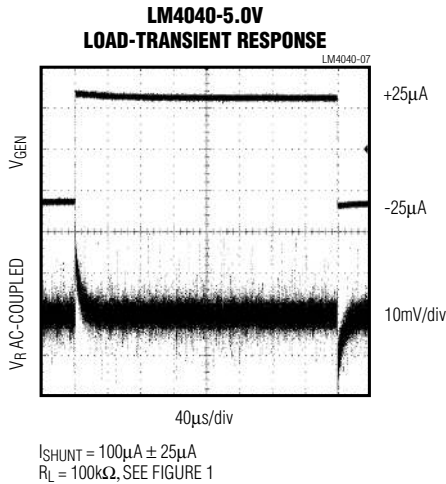
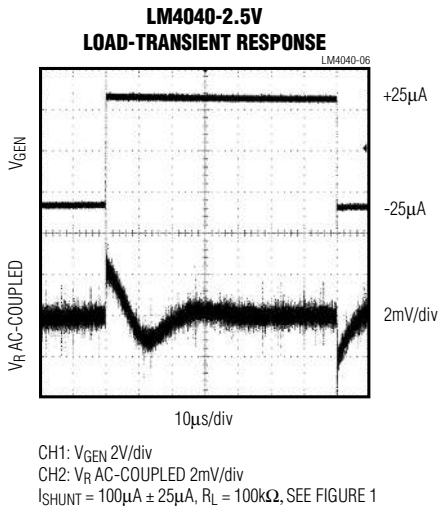

Figure 1. Load-Transient Test Circuit

Improved Precision Micropower Shunt Voltage Reference with Multiple Reverse Breakdown Voltages

Typical Operating Characteristics (continued)

($I_R = 100\mu\text{A}$, SC70 package, $T_A = +25^\circ\text{C}$, unless otherwise noted.)

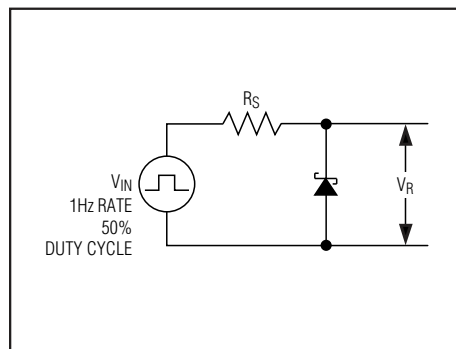
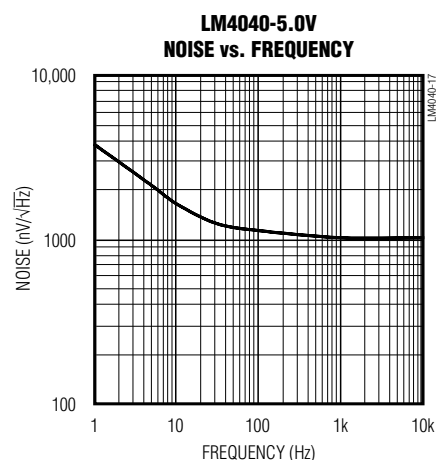
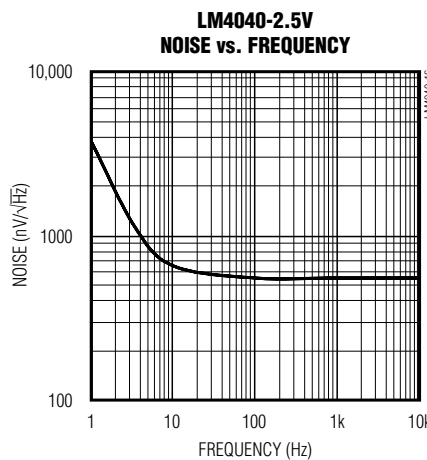
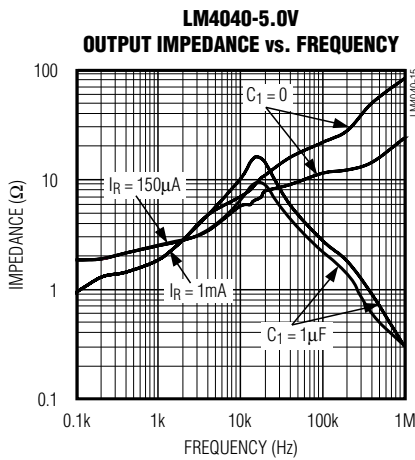
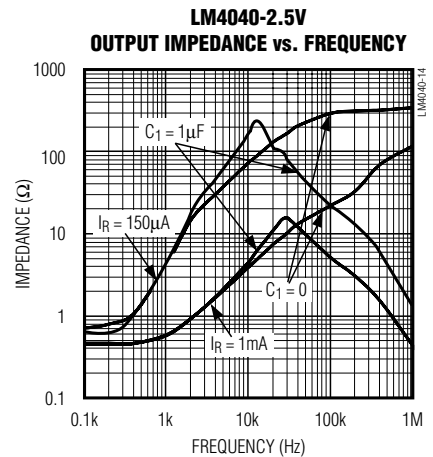
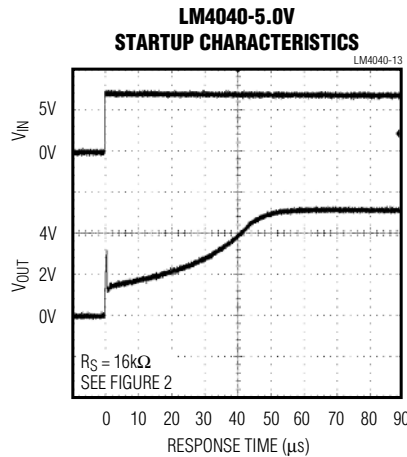
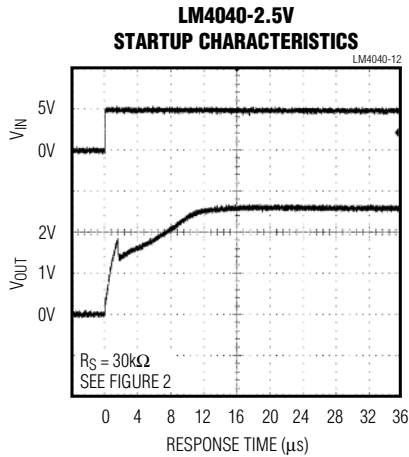

Figure 2. Startup Characteristics Test Circuit

Improved Precision Micropower Shunt Voltage Reference with Multiple Reverse Breakdown Voltages

LM4040

Pin Description

PIN	NAME	FUNCTION
1	+	Positive Terminal of the Shunt Reference
2	-	Negative Terminal of the Shunt Reference
3	N.C.	No connection. Leave this pin unconnected or connected to pin 2.

Detailed Description

The LM4040 shunt references use the bandgap principle to produce a stable, accurate voltage. The device behaves similarly to an ideal zener diode; a fixed voltage is maintained across its output terminals when biased with 60µA to 15mA of reverse current. The LM4040 behaves similarly to a silicon diode when biased with forward currents up to 10mA.

Figure 3 shows a typical operating circuit. The LM4040 is ideal for providing a stable reference from a high-voltage power supply.

Applications Information

The LM4040's internal pass transistor is used to maintain a constant output voltage (V_{SHUNT}) by sinking the necessary amount of current across a source resistor. The source resistance (R_S) is determined from the load current (I_{LOAD}) range, supply voltage (V_S) variations, V_{SHUNT} , and desired quiescent current.

Choose the value of R_S when V_S is at a minimum and I_{LOAD} is at a maximum. Maintain a minimum I_{SHUNT} of 60µA at all times. The R_S value should be large enough to keep I_{SHUNT} less than 15mA for proper regulation when V_S is maximum and I_{LOAD} is at a minimum. To prevent damage to the device, I_{SHUNT} should never exceed 20mA.

Therefore, the value of R_S is bounded by the following equation:

$$\frac{[V_S(\text{MIN}) - V_R]}{[60\mu\text{A} + I_{LOAD}(\text{MAX})]} > R_S > \frac{[V_S(\text{MAX}) - V_R]}{[20\text{mA} + I_{LOAD}(\text{MIN})]}$$

Choosing a larger resistance minimizes the total power dissipation in the circuit by reducing the shunt current ($P_{D(TOTAL)} = V_S \times I_{SHUNT}$). Provide a safety margin to incorporate the worst-case tolerance of the resistor used. Ensure that the resistor's power rating is adequate, using the following general power equation:

$$PDR = I_{SHUNT} \times (V_S(\text{MAX}) - V_{SHUNT})$$

Output Capacitance

The LM4040 does not require an external capacitor for frequency stability and is stable for any output capacitance.

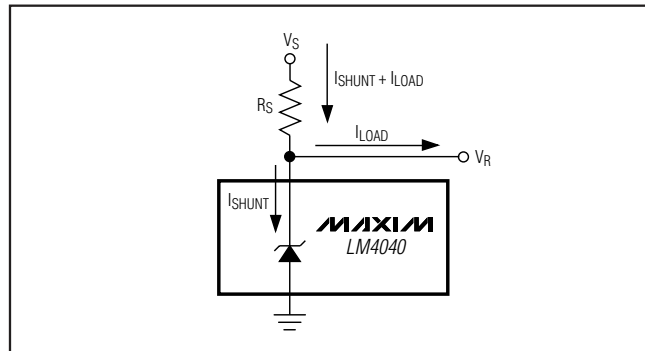

Figure 3. Typical Operating Circuit

Temperature Performance

The LM4040 typically exhibits an output voltage temperature coefficient within $\pm 15\text{ppm}/^\circ\text{C}$. The polarity of the temperature coefficient may be different from one device to another; some may have positive coefficients, and others may have negative coefficients.

High Temperature Operation

The maximum junction temperature of the LM4040 is $+150^\circ\text{C}$. The maximum operating temperature for the LM4040_E_ is $+125^\circ\text{C}$. At a maximum load current of 15mA and a maximum output voltage of 5V, the part will dissipate 75mW of power. The power dissipation limits of the 3-pin SC70 call for a derating value of $2.17\text{mW}/^\circ\text{C}$ above $+70^\circ\text{C}$ and thus for 75mW of power dissipation, the part will self-heat to 35.56°C above ambient temperature. If the ambient temperature is $+125^\circ\text{C}$, the part operates at 159.56°C , thereby exceeding the maximum junction temperature value of $+150^\circ\text{C}$. For high-temperature operation, care must be taken to ensure the combination of ambient temperature, output power dissipation and package thermal resistance does not conspire to raise the device temperature beyond that listed in the *Absolute Maximum Ratings*. Either reduce the output load current or the ambient temperature to keep the part within the limits.

Improved Precision Micropower Shunt Voltage Reference with Multiple Reverse Breakdown Voltages

LM4040

Ordering Information

PART	OUTPUT VOLTAGE (V)	INITIAL ACCURACY (%)	TEMPCO (ppm/°C)	TEMP RANGE	PIN-PACKAGE	TOP MARK
LM4040AIM3-2.1+T	2.048	0.1	100	-40°C to +85°C	3 SOT23	FZEF
LM4040AIX3-2.1+T	2.048	0.1	100	-40°C to +85°C	3 SC70	ABJ
LM4040BIM3-2.1+T	2.048	0.2	100	-40°C to +85°C	3 SOT23	FZEG
LM4040BIX3-2.1+T	2.048	0.2	100	-40°C to +85°C	3 SC70	ABK
LM4040CIM3-2.1+T	2.048	0.5	100	-40°C to +85°C	3 SOT23	FZEH
LM4040CIX3-2.1+T	2.048	0.5	100	-40°C to +85°C	3 SC70	ABL
LM4040DIM3-2.1+T	2.048	1.0	150	-40°C to +85°C	3 SOT23	FZEI
LM4040DIX3-2.1+T	2.048	1.0	150	-40°C to +85°C	3 SC70	ABM
LM4040AEM3-2.1+T	2.048	0.1	100	-40°C to +125°C	3 SOT23	FZNG
LM4040AEX3-2.1+T	2.048	0.1	100	-40°C to +125°C	3 SC70	ALF
LM4040BEM3-2.1-T	2.048	0.2	100	-40°C to +125°C	3 SOT23	FZNH
LM4040BEX3-2.1-T	2.048	0.2	100	-40°C to +125°C	3 SC70	ALG
LM4040CEM3-2.1-T	2.048	0.5	100	-40°C to +125°C	3 SOT23	FZNI
LM4040CEX3-2.1+T	2.048	0.5	100	-40°C to +125°C	3 SC70	ALH
LM4040DEM3-2.1+T	2.048	1.0	150	-40°C to +125°C	3 SOT23	FZNJ
LM4040DEX3-2.1+T	2.048	1.0	150	-40°C to +125°C	3 SC70	ALI
LM4040AIM3-2.5+T	2.500	0.1	100	-40°C to +85°C	3 SOT23	FZEJ
LM4040AIX3-2.5+T	2.500	0.1	100	-40°C to +85°C	3 SC70	ABN
LM4040BIM3-2.5+T	2.500	0.2	100	-40°C to +85°C	3 SOT23	FZEK
LM4040BIM3-2.5/V+T	2.500	0.2	100	-40°C to +125°C	3 SOT23	FZWL
LM4040BIX3-2.5+T	2.500	0.2	100	-40°C to +85°C	3 SC70	ABO
LM4040CIM3-2.5+T	2.500	0.5	100	-40°C to +85°C	3 SOT23	FZEL
LM4040CIX3-2.5+T	2.500	0.5	100	-40°C to +85°C	3 SC70	ABP
LM4040DIM3-2.5+T	2.500	1.0	150	-40°C to +85°C	3 SOT23	FZEM
LM4040DIX3-2.5+T	2.500	1.0	150	-40°C to +85°C	3 SC70	ABQ
LM4040AEM3-2.5+T	2.500	0.1	100	-40°C to +125°C	3 SOT23	FZNK
LM4040AEX3-2.5+T	2.500	0.1	100	-40°C to +125°C	3 SC70	ALJ
LM4040BEM3-2.5+T	2.500	0.2	100	-40°C to +125°C	3 SOT23	FZNL
LM4040BEX3-2.5+T	2.500	0.2	100	-40°C to +125°C	3 SC70	ALK
LM4040CEM3-2.5+T	2.500	0.5	100	-40°C to +125°C	3 SOT23	FZNM
LM4040CEM3-2.5/V+T	2.500	0.5	100	-40°C to +125°C	3 SOT23	FZVZ
LM4040CEX3-2.5+T	2.500	0.5	100	-40°C to +125°C	3 SC70	ALL
LM4040DEM3-2.5+T	2.500	1.0	150	-40°C to +125°C	3 SOT23	FZNN
LM4040DEX3-2.5+T	2.500	1.0	150	-40°C to +125°C	3 SC70	ALM

+Denotes a lead(Pb)-free/RoHS-compliant package.

T = Tape and reel.

Improved Precision Micropower Shunt Voltage Reference with Multiple Reverse Breakdown Voltages

Ordering Information (continued)

PART	OUTPUT VOLTAGE (V)	INITIAL ACCURACY (%)	TEMPCO (ppm/°C)	TEMP RANGE	PIN-PACKAGE	TOP MARK
LM4040AIM3-3.0+T	3.000	0.1	100	-40°C to +85°C	3 SOT23	FZEN
LM4040AIX3-3.0+T	3.000	0.1	100	-40°C to +85°C	3 SC70	ABR
LM4040BIM3-3.0+T	3.000	0.2	100	-40°C to +85°C	3 SOT23	FZEO
LM4040BIX3-3.0+T	3.000	0.2	100	-40°C to +85°C	3 SC70	ABS
LM4040CIM3-3.0+T	3.000	0.5	100	-40°C to +85°C	3 SOT23	FZEP
LM4040CIX3-3.0+T	3.000	0.5	100	-40°C to +85°C	3 SC70	ABT
LM4040DIM3-3.0+T	3.000	1.0	150	-40°C to +85°C	3 SOT23	FZEQ
LM4040DIX3-3.0+T	3.000	1.0	150	-40°C to +85°C	3 SC70	ABU
LM4040AEM3-3.0+T	3.000	0.1	100	-40°C to +125°C	3 SOT23	FZNO
LM4040AEX3-3.0+T	3.000	0.1	100	-40°C to +125°C	3 SC70	ALN
LM4040BEM3-3.0+T	3.000	0.2	100	-40°C to +125°C	3 SOT23	FZNP
LM4040BEX3-3.0+T	3.000	0.2	100	-40°C to +125°C	3 SC70	ALO
LM4040CEX3-3.0+T	3.000	0.5	100	-40°C to +125°C	3 SC70	ALP
LM4040DEM3-3.0+T	3.000	1.0	150	-40°C to +125°C	3 SOT23	FZNR
LM4040DEX3-3.0+T	3.000	1.0	150	-40°C to +125°C	3 SC70	ALQ
LM4040AEX3-3.3+T	3.300	0.1	100	-40°C to +125°C	3 SC70	ANY
LM4040BEX3-3.3+T	3.300	0.2	100	-40°C to +125°C	3 SC70	ANZ
LM4040CEX3-3.3+T	3.300	0.5	100	-40°C to +125°C	3 SC70	AOA
LM4040DEX3-3.3+T	3.300	1.0	150	-40°C to +125°C	3 SC70	AOB
LM4040AIM3-4.1+T	4.096	0.1	100	-40°C to +85°C	3 SOT23	FZER
LM4040AIX3-4.1+T	4.096	0.1	100	-40°C to +85°C	3 SC70	ABV
LM4040BIM3-4.1+T	4.096	0.2	100	-40°C to +85°C	3 SOT23	FZES
LM4040BIX3-4.1+T	4.096	0.2	100	-40°C to +85°C	3 SC70	ABW
LM4040CIM3-4.1+T	4.096	0.5	100	-40°C to +85°C	3 SOT23	FZET
LM4040CIX3-4.1+T	4.096	0.5	100	-40°C to +85°C	3 SC70	ABX
LM4040DIM3-4.1+T	4.096	1.0	150	-40°C to +85°C	3 SOT23	FZEU
LM4040DIX3-4.1+T	4.096	1.0	150	-40°C to +85°C	3 SC70	ABY
LM4040AEM3-4.1+T	4.096	0.1	100	-40°C to +125°C	3 SOT23	FZNS
LM4040AEX3-4.1+T	4.096	0.1	100	-40°C to +125°C	3 SC70	ALR
LM4040BEM3-4.1+T	4.096	0.2	100	-40°C to +125°C	3 SOT23	FZNT
LM4040BEX3-4.1+T	4.096	0.2	100	-40°C to +125°C	3 SC70	ALS
LM4040CEM3-4.1+T	4.096	0.5	100	-40°C to +125°C	3 SOT23	FZNU

+Denotes a lead(Pb)-free/RoHS-compliant package.

T = Tape and reel.

LM4040

Improved Precision Micropower Shunt Voltage Reference with Multiple Reverse Breakdown Voltages

Ordering Information (continued)

PART	OUTPUT VOLTAGE (V)	INITIAL ACCURACY (%)	TEMPCO (ppm/°C)	TEMP RANGE	PIN-PACKAGE	TOP MARK
LM4040CEX3-4.1+T	4.096	0.5	100	-40°C to +125°C	3 SC70	ALT
LM4040DEM3-4.1+T	4.096	1.0	150	-40°C to +125°C	3 SOT23	FZNV
LM4040DEM3-4.1/V+T	4.096	1.0	150	-40°C to +125°C	3 SOT23	FZWA
LM4040DEX3-4.1+T	4.096	1.0	150	-40°C to +125°C	3 SC70	ALU
LM4040AIM3-5.0+T	5.000	0.1	100	-40°C to +85°C	3 SOT23	FZEV
LM4040AIX3-5.0+T	5.000	0.1	100	-40°C to +85°C	3 SC70	ABZ
LM4040BIM3-5.0+T	5.000	0.2	100	-40°C to +85°C	3 SOT23	FZEW
LM4040BIX3-5.0+T	5.000	0.2	100	-40°C to +85°C	3 SC70	ACA
LM4040CIM3-5.0+T	5.000	0.5	100	-40°C to +85°C	3 SOT23	FZEX
LM4040CIX3-5.0+T	5.000	0.5	100	-40°C to +85°C	3 SC70	ACB
LM4040DIM3-5.0+T	5.000	1.0	150	-40°C to +85°C	3 SOT23	FZEY
LM4040DIX3-5.0+T	5.000	1.0	150	-40°C to +85°C	3 SC70	ACC
LM4040AEM3-5.0+T	5.000	0.1	100	-40°C to +125°C	3 SOT23	FZNW
LM4040AEM3-5.0/V+T	5.000	0.1	100	-40°C to +125°C	3 SOT23	FZWB
LM4040AEX3-5.0+T	5.000	0.1	100	-40°C to +125°C	3 SC70	ALV
LM4040BEM3-5.0+T	5.000	0.2	100	-40°C to +125°C	3 SOT23	FZNX
LM4040BEX3-5.0+T	5.000	0.2	100	-40°C to +125°C	3 SC70	ALW
LM4040CEM3-5.0+T	5.000	0.5	100	-40°C to +125°C	3 SOT23	FZNY
LM4040CEM3-5.0/V+T	5.000	0.5	100	-40°C to +125°C	3 SOT23	+FZWC
LM4040CEX3-5.0+T	5.000	0.5	100	-40°C to +125°C	3 SC70	ALX
LM4040DEM3-5.0+T	5.000	1.0	150	-40°C to +125°C	3 SOT23	FZNZ
LM4040DEX3-5.0+T	5.000	1.0	150	-40°C to +125°C	3 SC70	ALY

+Denotes a lead(Pb)-free/RoHS-compliant package.

T = Tape and reel.

Chip Information

PROCESS: BiCMOS

Package Information

For the latest package outline information and land patterns (footprints), go to www.maxim-ic.com/packages. Note that a "+", "#", or "-" in the package code indicates RoHS status only. Package drawings may show a different suffix character, but the drawing pertains to the package regardless of RoHS status.

PACKAGE TYPE	PACKAGE CODE	OUTLINE NO.	LAND PATTERN NO.
6 µDFN	L611+1	21-0147	90-0080
6 Thin SOT23	Z6+1	21-0114	90-0242

Improved Precision Micropower Shunt Voltage Reference with Multiple Reverse Breakdown Voltages

Revision History

REVISION NUMBER	REVISION DATE	DESCRIPTION	PAGES CHANGED
0	8/00	Initial release	—
5	7/05	Updated <i>Electrical Characteristics</i> .	2-7
6	4/11	Updated <i>Selector Guide</i> , <i>Absolute Maximum Ratings</i> , and <i>Ordering Information</i> .	1, 2, 12, 13, 14
7	11/11	Add IV+ automotive-qualified identification to the <i>Selector Guide</i> and <i>Ordering Information</i> .	1, 12

LM4040

Maxim cannot assume responsibility for use of any circuitry other than circuitry entirely embodied in a Maxim product. No circuit patent licenses are implied. Maxim reserves the right to change the circuitry and specifications without notice at any time. The parametric values (min and max limits) shown in the Electrical Characteristics table are guaranteed. Other parametric values quoted in this data sheet are provided for guidance.

15 _____ **Maxim Integrated Products, 120 San Gabriel Drive, Sunnyvale, CA 94086 408-737-7600**