

TPS2214A, TPS2216A DUAL-SLOT PC CARD POWER SWITCHES FOR SERIAL PCMCIA CONTROLLERS

SLVS267C – DECEMBER 1999 – REVISED FEBRUARU 2008

- Provides S-CARD and M-CARD Power Management for CableCARD™ Applications
- Fully Integrated xVCC and xVPP Switching
- xVPP Programmed Independent of xVCC
- 3.3-V, 5-V, and/or 12-V Power Distribution
- Low $r_{DS(on)}$ (60-m Ω 3.3-V xVCC Switch and 140-m Ω 5-V xVCC Switch Typical)
- Short Circuit and Thermal Protection
- 150- μ A (Maximum) Quiescent Current
- Standby Mode: 50-mA Current Limit (Typ)
- 12-V Supply Can Be Disabled
- 3.3-V Low-Voltage Mode
- Ambient Temperature . . . -40°C to 70°C
- Meets PC Card™ Standards
- TTL-Logic Compatible Inputs
- Available in 24-Pin and 30-Pin SSOP (DB), and 32-Pin TSSOP (DAP) Packages
- Break-Before-Make Switching
- Internal Power-On Reset

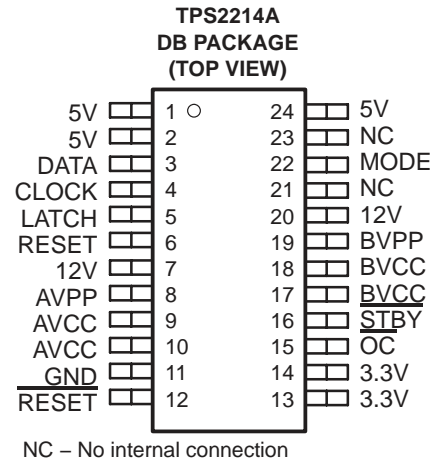

PINOUTS FOR TPS2216A DAP AND DB
PACKAGES ARE PROVIDED ON PAGE 2.

description

The TPS2214A and TPS2216A PC Card power-interface switches provide an integrated power-management solution for two PC Cards. All of the discrete power MOSFETs, a logic section, current limiting, and thermal protection for PC Card control are combined on single integrated circuits. These low-cost devices allow the distribution of 3.3-V, 5-V, and/or 12-V power to the card. The current-limiting feature eliminates the need for fuses. Current-limit reporting can help the user isolate a system fault.

The TPS2214A and TPS2216A feature a 3.3-V low-voltage mode that allows for 3.3-V switching without the need for 5-V power. This feature facilitates low-power system designs such as sleep modes where only 3.3 V is available. These devices also have the ability to program the xVPP outputs independent of the xVCC outputs. A standby mode that changes all output-current limits to 50 mA (typical) has been incorporated.

End-equipment applications for these products include: notebook computers, desktop computers, personal digital assistants (PDAs), digital cameras, and bar-code scanners.

The TPS2216A is backward-compatible with the TPS2202A, TPS2206, and TPS2216. The TPS2214A is backward-compatible with the TPS2214.

AVAILABLE OPTIONS

| T _A | PACKAGED DEVICES† | |
|----------------|------------------------------|---------------------------------------|
| | PLASTIC SMALL OUTLINE (DB) | PowerPAD PLASTIC SMALL OUTLINE™ (DAP) |
| -40°C to 70°C | TPS2214ADB(R), TPS2216ADB(R) | TPS2216ADAP(R) |

† The DB and DAP packages are available in tubes and left-end taped and reeled. Add R suffix to device type (e.g., TPS2216ADB(R)) for taped and reeled.



Please be aware that an important notice concerning availability, standard warranty, and use in critical applications of Texas Instruments semiconductor products and disclaimers thereto appears at the end of this data sheet.

PowerPAD is a trademark of Texas Instruments.

PC Card is a trademark of PCMCIA (Personal Computer Memory Card International Association).

CableCard is a trademark of Cable Television Laboratories, Inc. All other trademarks are the property of their respective owners.

PRODUCTION DATA information is current as of publication date. Products conform to specifications per the terms of Texas Instruments standard warranty. Production processing does not necessarily include testing of all parameters.



POST OFFICE BOX 655303 • DALLAS, TEXAS 75265

Copyright © 2008, Texas Instruments Incorporated

TPS2214A, TPS2216A DUAL-SLOT PC CARD POWER SWITCHES FOR SERIAL PCMCIA CONTROLLERS

SLVS267C – DECEMBER 1999 – REVISED FEBRUARU 2008

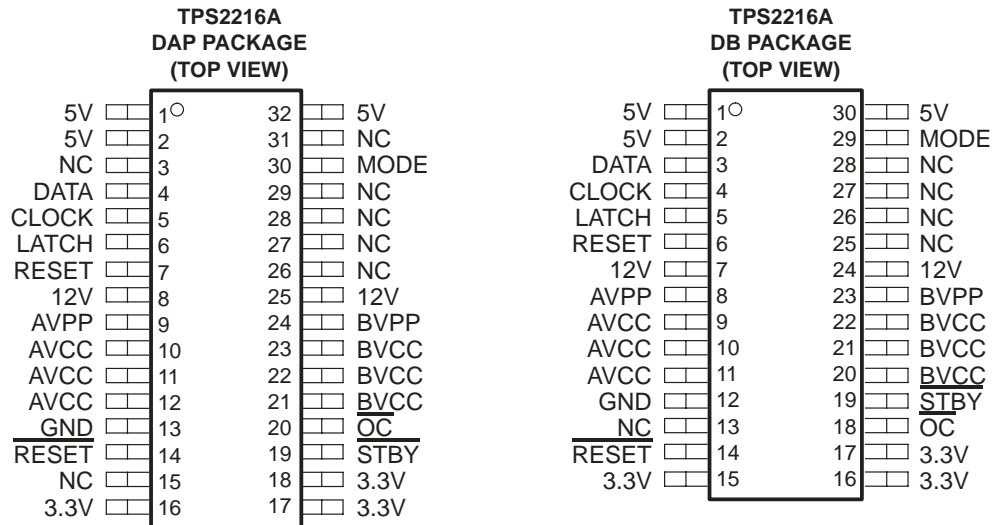

NC – No internal connection

Terminal Functions

| NAME | TERMINAL NO. | | | I/O | DESCRIPTION |
|-------|--------------|--------------------|---------------------------|-----|--|
| | TPS2214 | | TPS2216 | | |
| | DB-24 | DB-30 | DAP | | |
| 3.3V | 13, 14 | 15, 16, 17 | 16, 17, 18 | I | 3.3-V input for card power and/or chip power if 5 V is not present |
| 5V | 1, 2, 24 | 1, 2, 30 | 1, 2, 32 | I | 5-V input for card power and/or chip power |
| 12V | 7, 20 | 7, 24 | 8, 25 | I | 12-V V_{pp} input card power |
| AVCC | 9, 10 | 9, 10, 11 | 10, 11, 12 | O | VCC output: 3.3-V, 5-V, GND or high impedance to card |
| AVPP | 8 | 8 | 9 | O | VPP output: 3.3-V, 5-V, 12-V, GND or high impedance to card |
| BVCC | 17, 18 | 20, 21, 22 | 21, 22, 23 | O | VCC output: 3.3-V, 5-V, GND or high impedance to card |
| BVPP | 19 | 23 | 24 | O | VPP output: 3.3-V, 5-V, 12-V, GND or high impedance to card |
| GND | 11 | 12 | 13 | | Ground |
| MODE | 22 | 29 | 30 | I | TPS2206 operation when floating or pulled low; must be pulled high externally for TPS2216A operation. MODE is internally pulled low with a 150-k Ω pulldown resistor. |
| OC | 15 | 18 | 20 | O | Logic-level output that goes low when an overcurrent or overtemperature condition exists. |
| RESET | 6 | 6 | 7 | I | Logic-level reset input active high. Do not connect if RESET pin is used. RESET is internally pulled low with a 150-k Ω pulldown resistor. |
| RESET | 12 | 14 | 14 | I | Logic-level reset input active low. Do not connect if RESET pin is used. The pin is internally pulled high with a 150-k Ω pullup resistor. |
| STBY | 16 | 19 | 19 | I | Logic-level active low input sets the TPS2216 to standby mode and sets all current limits to 50 mA. The pin is internally pulled high with a 150-k Ω pullup resistor. |
| CLOCK | 4 | 4 | 5 | I | Logic-level clock for serial data word |
| DATA | 3 | 3 | 4 | I | Logic-level serial data word |
| LATCH | 5 | 5 | 6 | I | Logic-level latch for serial data word |
| NC | 21, 23 | 13, 25, 26, 27, 28 | 3, 15, 26, 27, 28, 29, 31 | | No internal connection |



TPS2214A, TPS2216A DUAL-SLOT PC CARD POWER SWITCHES FOR SERIAL PCMCIA CONTROLLERS

SLVS267C – DECEMBER 1999 – REVISED FEBRUARU 2008

functional block diagram (pin numbers refer to 30-pin DB package)

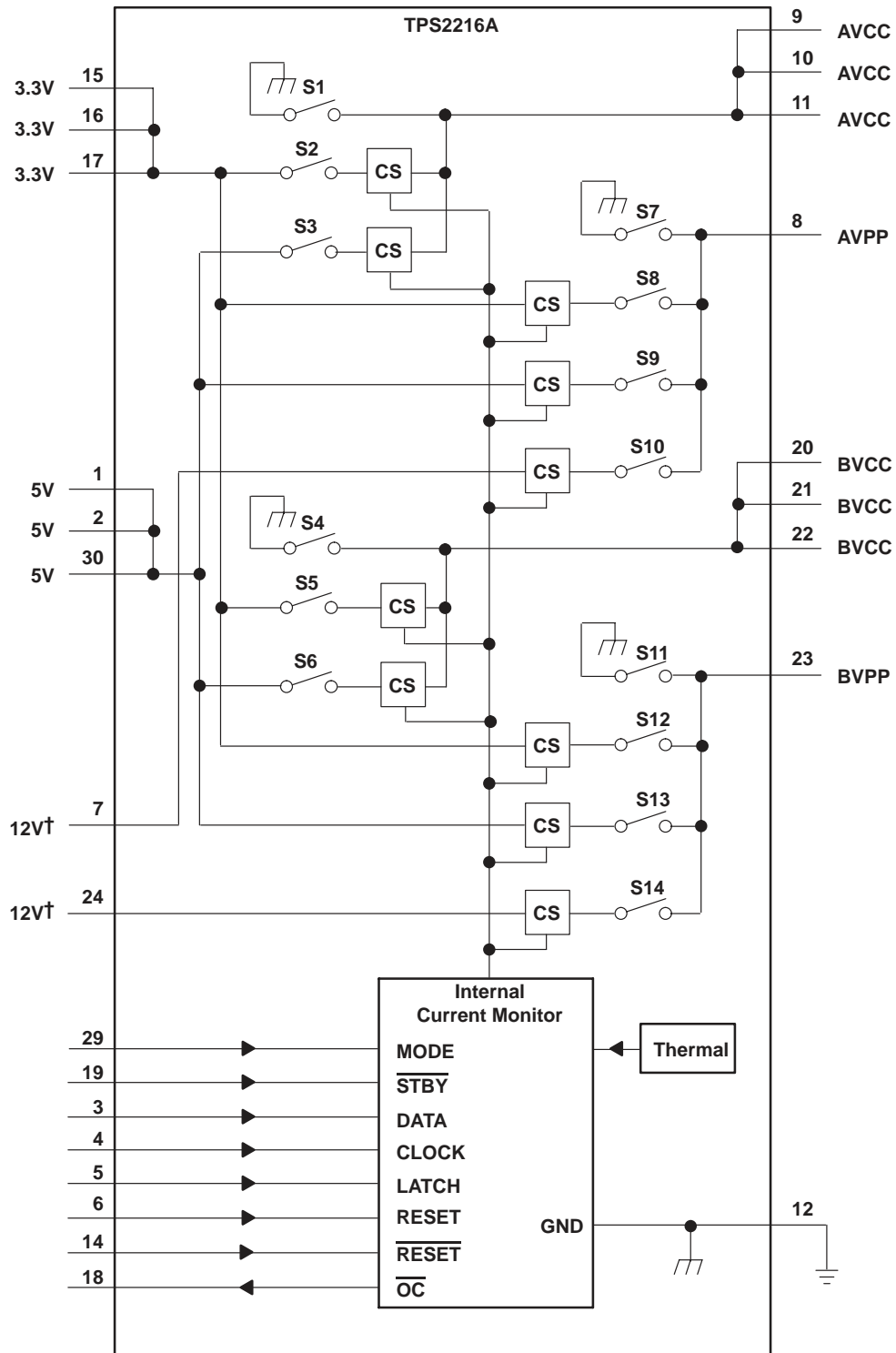

† Both 12V pins must be connected together.

TPS2214A, TPS2216A DUAL-SLOT PC CARD POWER SWITCHES FOR SERIAL PCMCIA CONTROLLERS

SLVS267C – DECEMBER 1999 – REVISED FEBRUARU 2008

absolute maximum ratings over operating virtual free-air temperature (unless otherwise noted)†

| | |
|--|------------------------------|
| Input voltage range for card power: $V_{I(3.3V)}$ | -0.3 V to 6 V |
| $V_{I(5V)}$ | -0.3 V to 6 V |
| $V_{I(12V)}$ | -0.3 V to 14 V |
| Logic input voltage | -0.3 V to 6 V |
| Output voltage range: $V_{O(xVCC)}$ | -0.3 V to 6 V |
| $V_{O(xVPP)}$ | -0.3 V to 14 V |
| Continuous total power dissipation | See Dissipation Rating Table |
| Output current: $I_{O(xVCC)}$ | Internally limited |
| $I_{O(xVPP)}$ | Internally limited |
| Operating virtual junction temperature range, T_J | -40°C to 125°C |
| Storage temperature range, T_{stg} | -55°C to 150°C |
| Lead temperature 1,6 mm (1/16 inch) from case for 10 seconds | 260°C |

† Stresses beyond those listed under “absolute maximum ratings” may cause permanent damage to the device. These are stress ratings only, and functional operation of the device at these or any other conditions beyond those indicated under “recommended operating conditions” is not implied. Exposure to absolute-maximum-rated conditions for extended periods may affect device reliability.

DISSIPATION RATING TABLE

| PACKAGE | $T_A \leq 25^\circ\text{C}$ POWER RATING | DERATING FACTOR‡ ABOVE $T_A = 25^\circ\text{C}$ | $T_A = 70^\circ\text{C}$ POWER RATING | $T_A = 85^\circ\text{C}$ POWER RATING |
|---------|---|--|--|--|
| DB | 1095 mW | 10.99 mW/°C | 602 mW | 438 mW |
| DAP | 4255 mW | 42.55 mW/°C | 2340 mW | 1702 mW |

‡ These devices are mounted on an JEDEC low-k board (2 oz. traces on surface), 1-W power applied.

recommended operating conditions

| | | MIN | MAX | UNIT |
|---|--|-----|------|------|
| Input voltage, V_I | $V_{I(3.3V)}$ | 2.7 | 5.25 | V |
| | $V_{I(5V)}$ | 2.7 | 5.25 | V |
| | $V_{I(12V)}$ | 2.7 | 13.5 | V |
| Output current, I_O | $I_{O(VCC)}$ at $T_A = 70^\circ\text{C}$ | | 750 | mA |
| | $I_{O(VPP)}$ at $T_A = 70^\circ\text{C}$ | | 200 | mA |
| Clock frequency | | | 2.5 | MHz |
| Pulse duration | Data | 200 | | ns |
| | Latch | 250 | | |
| | Clock | 100 | | |
| Data hold time§ | | 100 | | ns |
| Data setup time§ | | 100 | | ns |
| Latch delay time§ | | 100 | | ns |
| Clock delay time§ | | 250 | | ns |
| Operating virtual junction temperature, T_J | | -40 | 100 | °C |

§ Refer to Figures 2 and 3.



TPS2214A, TPS2216A
DUAL-SLOT PC CARD POWER SWITCHES
FOR SERIAL PCMCIA CONTROLLERS

SLVS267C – DECEMBER 1999 – REVISED FEBRUARU 2008

electrical characteristics, $T_J = 25^\circ\text{C}$, $V_{I(5V)} = 5\text{ V}$, $V_{I(3.3V)} = 3.3\text{ V}$, $V_{I(12V)} = 12\text{ V}$, $\overline{\text{STBY}}$ floating, all outputs unloaded (unless otherwise noted)

power switch

| PARAMETER | | TEST CONDITIONS | MIN | TYP | MAX | UNIT | | |
|--|---|---|---|---|------|------------------|---------------|---------------|
| Switch resistance† | 3.3 V to xVCC, with one or two switches on | $T_J = 25^\circ\text{C}$, $V_{I(5V)} = 0$ or 5 , $I_O = 750\text{ mA}$ | | 60 | 105 | m Ω | | |
| | | $T_J = 85^\circ\text{C}$, $V_{I(5V)} = 0$ or 5 , $I_O = 750\text{ mA}$ | | 90 | 140 | | | |
| | 5 V to xVCC, with one or two switches on | $T_J = 25^\circ\text{C}$, $I_O = 750\text{ mA}$ | | 140 | 185 | | | |
| | | $T_J = 85^\circ\text{C}$, $I_O = 750\text{ mA}$ | | 160 | 200 | | | |
| | 3.3 V/5 V/12 V to xVPP | $T_J = 25^\circ\text{C}$, $I_O = 50\text{ mA}$ | | 0.7 | 1.5 | Ω | | |
| | | | $T_J = 85^\circ\text{C}$, $I_O = 50\text{ mA}$ | | 1.4 | | 2.5 | |
| | | 3.3 V/5 V to xVCC | $T_J = 25^\circ\text{C}$, $\overline{\text{STBY}} = \text{low}$, $I_O = 30\text{ mA}$ | | 1.4 | | 2 | |
| | | | $T_J = 85^\circ\text{C}$, $\overline{\text{STBY}} = \text{low}$, $I_O = 30\text{ mA}$ | | 2 | | 3 | |
| 3.3 V/5 V/12 V to xVPP | $T_J = 25^\circ\text{C}$, $\overline{\text{STBY}} = \text{low}$, $I_O = 30\text{ mA}$ | | 5 | 7 | | | | |
| | $T_J = 85^\circ\text{C}$, $\overline{\text{STBY}} = \text{low}$, $I_O = 30\text{ mA}$ | | 10 | 16 | | | | |
| Clamp low voltage | $V_{O(xVCC)}$ | $I_{O(xVCC)}$ at 10 mA, After reset | | 0.275 | 0.8 | V | | |
| | $V_{O(xVPP)}$ | $I_{O(xVPP)}$ at 10 mA, After reset | | 0.275 | 0.8 | | | |
| I_{lkg} Leakage current | $I_{O(xVCC)}$ high-impedance state | $T_J = 25^\circ\text{C}$ | | 1 | 10 | μA | | |
| | | $T_J = 85^\circ\text{C}$ | | 2 | 50 | | | |
| | $I_{O(xVPP)}$ high-impedance state | $T_J = 25^\circ\text{C}$ | | 1 | 10 | | | |
| | | $T_J = 85^\circ\text{C}$ | | 2 | 50 | | | |
| I_{OS} Short-circuit output current limit† | $I_{O(xVCC)}$ | $T_J = 85^\circ\text{C}$, Output powered into a short to GND | | 1 | 2.5 | A | | |
| | $I_{O(xVPP)}$ | | | 250 | 500 | mA | | |
| | Standby mode, $I_{O(xVCC)}$ | $T_J = 85^\circ\text{C}$, Output powered into a short to GND, | | 35 | 65 | mA | | |
| | Standby mode, $I_{O(xVPP)}$ | $\overline{\text{STBY}} = 0\text{ V}$ | | 30 | 60 | | | |
| Current limit response time‡ | xVCC switch | 100-m Ω short circuit | | 100 | | μs | | |
| | xVPP switch | | | 16 | | | | |
| I_I Input current§ | Normal operation and in reset mode | $I_I(3.3V)$ | $V_{O(xVCC)} = V_{O(xVPP)} = 5\text{ V}$ | | 0.01 | 2 | μA | |
| | | $I_I(5V)$ | | | 100 | 120 | | |
| | | $I_I(12V)$ | | | 6 | 10 | | |
| | | $I_I(3.3V)$ | | $V_{I(5V)} = 0$, $V_{O(xVCC)} = 3.3\text{ V}$, $V_{O(xVPP)} = 12\text{ V}$ | | 100 | 120 | μA |
| | | $I_I(5V)$ | | | | 0 | | |
| | | $I_I(12V)$ | | | | 22 | 30 | |
| | Shutdown mode | $I_I(3.3V)$ | $V_{O(xVCC)} = \text{Hi-Z}$, $V_{O(xVPP)} = \text{Hi-Z}$ | | 1 | | μA | |
| | | $I_I(5V)$ | | | 1 | | | |
| | | $I_I(12V)$ | | | 1 | | | |
| Thermal shutdown‡ | Trip point, T_J | | | 155 | | $^\circ\text{C}$ | | |
| | Hysteresis | | | 10 | | | | |

† Pulse-testing techniques maintain junction temperature close to ambient temperature (250- μs -wide pulse, less than 0.5% duty cycle); thermal effects must be taken into account separately.

‡ Specified by design, not tested in production.

§ Input currents do not include logic input currents (presented in electrical characteristics for logic section); clock is inactive.

NOTE: $V_{I(3.3V)}$ or $V_{I(5V)}$ must be biased for switches to function.



TPS2214A, TPS2216A
DUAL-SLOT PC CARD POWER SWITCHES
FOR SERIAL PCMCIA CONTROLLERS

SLVS267C – DECEMBER 1999 – REVISED FEBRUARU 2008

electrical characteristics, $T_J = 25^\circ\text{C}$, $V_{I(5V)} = 5\text{ V}$, $V_{I(3.3V)} = 3.3\text{ V}$, $V_{I(12V)} = 12\text{ V}$, $\overline{\text{STBY}}$ floating, all outputs unloaded (unless otherwise noted) (continued)

logic section (CLOCK, DATA, LATCH, MODE, RESET, $\overline{\text{RESET}}$, $\overline{\text{STBY}}$, $\overline{\text{OC}}$)

| PARAMETER | | TEST CONDITIONS | MIN | TYP | MAX | UNIT |
|--|---|---|---------------------|-----|-----|---------------|
| Logic input current | $I_{I(\text{RESET})}$ or $I_{I(\overline{\text{RESET}})}^\dagger$ | $V_{I(\text{RESET})} = 5\text{ V}$ or $V_{I(\overline{\text{RESET}})} = 0\text{ V}$ | | 30 | 50 | μA |
| | | $V_{I(\text{RESET})} = 0\text{ V}$ or $V_{I(\overline{\text{RESET}})} = 5\text{ V}$ | | | 1 | |
| | $I_{I(\text{MODE})}^\dagger$ | $V_{I(\text{MODE})} = 5\text{ V}$ | | 30 | 50 | |
| | | $V_{I(\text{MODE})} = 0\text{ V}$ | | | 1 | |
| | $I_{I(\overline{\text{STBY}})}^\dagger$ | $V_{I(\overline{\text{STBY}})} = 5\text{ V}$ | | | 1 | |
| | | $V_{I(\overline{\text{STBY}})} = 0\text{ V}$ | | 30 | 50 | |
| $I_{I(\text{CLOCK})}$ or $I_{I(\text{DATA})}$ or $I_{I(\text{LATCH})}$ | | | | | 1 | |
| Logic input high level | $V_{I(5V)} = 5\text{ V}$ | | 2 | | | V |
| | $V_{I(5V)} = 0\text{ V}$ | | 2 | | | |
| Logic input low level | | | | | 0.8 | V |
| Logic output high level, $\overline{\text{OC}}$ | $V_{I(5V)} = 5\text{ V}$, $I_O = 1\text{ mA}$ | | $V_{I(5V)} - 0.4$ | | | V |
| | $V_{I(5V)} = 0\text{ V}$, $I_O = 1\text{ mA}$ | | $V_{I(3.3V)} - 0.4$ | | | |
| Logic output low level, $\overline{\text{OC}}$ | $I_O = 1\text{ mA}$ | | | | 0.4 | V |

† RESET and MODE have internal 150-k Ω pulldown resistors; $\overline{\text{RESET}}$ and $\overline{\text{STBY}}$ have internal 150-k Ω pullup resistors.



TPS2214A, TPS2216A
DUAL-SLOT PC CARD POWER SWITCHES
FOR SERIAL PCMCIA CONTROLLERS

SLVS267C – DECEMBER 1999 – REVISED FEBRUARU 2008

switching characteristics

| PARAMETER† | LOAD CONDITION† | TEST CONDITIONS† | MIN | TYP | MAX | UNIT |
|---|---|---|---------------|------|-----|------|
| t_r Output rise times‡ | $C_L(xVCC) = 0.1 \mu F$, $C_L(xVPP) = 0.1 \mu F$, $I_O(xVCC) = 0S$, $I_O(xVPP) = 0S$ | $V_O(xVCC)$ | | 1 | | ms |
| | | $V_O(xVPP)$ | | 0.8 | | |
| | $C_L(xVCC) = 150 \mu F$, $C_L(xVPP) = 10 \mu F$, $I_O(xVCC) = 1 A$, $I_O(xVPP) = 50 mA$ | $V_O(xVCC)$ | | 1.2 | | |
| | | $V_O(xVPP)$ | | 2.5 | | |
| t_f Output fall times‡ | $C_L(xVCC) = 0.1 \mu F$, $C_L(xVPP) = 0.1 \mu F$, $I_O(xVCC) = 0S$, $I_O(xVPP) = 0S$ | $V_O(xVCC)$ | | 0.01 | | ms |
| | | $V_O(xVPP)$ | | 0.01 | | |
| | $C_L(xVCC) = 150 \mu F$, $C_L(xVPP) = 10 \mu F$, $I_O(xVCC) = 1 A$, $I_O(xVPP) = 50 mA$ | $V_O(xVCC)$ | | 3 | | |
| | | $V_O(xVPP)$ | | 8 | | |
| t_{pd} Propagation delay‡ | $C_L(xVCC) = 0.1 \mu F$, $C_L(xVPP) = 0.1 \mu F$, $I_O(xVCC) = 0S$, $I_O(xVPP) = 0S$ | Latch↑ to xVPP (12 V) | $t_{pd}(on)$ | 3 | | ms |
| | | | $t_{pd}(off)$ | 25 | | |
| | | Latch↑ to xVPP (5 V) | $t_{pd}(on)$ | 0.6 | | |
| | | | $t_{pd}(off)$ | 8.5 | | |
| | | Latch↑ to xVPP (3.3 V), $V_I(5V) = 5 V$ | $t_{pd}(on)$ | 0.6 | | |
| | | | $t_{pd}(off)$ | 9 | | |
| | | Latch↑ to xVPP (3.3 V), $V_I(5V) = 0 V$ | $t_{pd}(on)$ | 1.4 | | |
| | | | $t_{pd}(off)$ | 9 | | |
| | Latch↑ to xVCC (5 V) | $t_{pd}(on)$ | 0.3 | | | |
| | | $t_{pd}(off)$ | 15 | | | |
| | Latch↑ to xVCC (3.3 V), $V_I(5V) = 5 V$ | $t_{pd}(on)$ | 0.2 | | | |
| | | $t_{pd}(off)$ | 15 | | | |
| | Latch↑ to xVCC (3.3 V), $V_I(5V) = 0 V$ | $t_{pd}(on)$ | 0.4 | | | |
| | | $t_{pd}(off)$ | 15 | | | |
| | $C_L(xVCC) = 150 \mu F$, $C_L(xVPP) = 10 \mu F$, $I_O(xVCC) = 1 A$, $I_O(xVPP) = 50 mA$ | Latch↑ to xVPP (12 V) | $t_{pd}(on)$ | 4.5 | | |
| | | | $t_{pd}(off)$ | 13 | | |
| Latch↑ to xVPP (5 V) | | $t_{pd}(on)$ | 3.3 | | | |
| | | $t_{pd}(off)$ | 8 | | | |
| Latch↑ to xVPP (3.3 V), $V_I(5V) = 5 V$ | | $t_{pd}(on)$ | 3 | | | |
| | | $t_{pd}(off)$ | 9 | | | |
| Latch↑ to xVPP (3.3 V), $V_I(5V) = 0 V$ | | $t_{pd}(on)$ | 3 | | | |
| | | $t_{pd}(off)$ | 9 | | | |
| Latch↑ to xVCC (5 V) | $t_{pd}(on)$ | 1 | | | | |
| | $t_{pd}(off)$ | 12 | | | | |
| Latch↑ to xVCC (3.3 V), $V_I(5V) = 5 V$ | $t_{pd}(on)$ | 0.6 | | | | |
| | $t_{pd}(off)$ | 12 | | | | |
| Latch↑ to xVCC (3.3 V), $V_I(5V) = 0 V$ | $t_{pd}(on)$ | 1 | | | | |
| | $t_{pd}(off)$ | 12 | | | | |

† Refer to *Parameter Measurement Information*

‡ Specified by design; not tested in production.

§ No card inserted, assumes 0.1- μF recommended output capacitor (see Figure 32).



TPS2214A, TPS2216A DUAL-SLOT PC CARD POWER SWITCHES FOR SERIAL PCMCIA CONTROLLERS

SLVS267C – DECEMBER 1999 – REVISED FEBRUARU 2008

PARAMETER MEASUREMENT INFORMATION

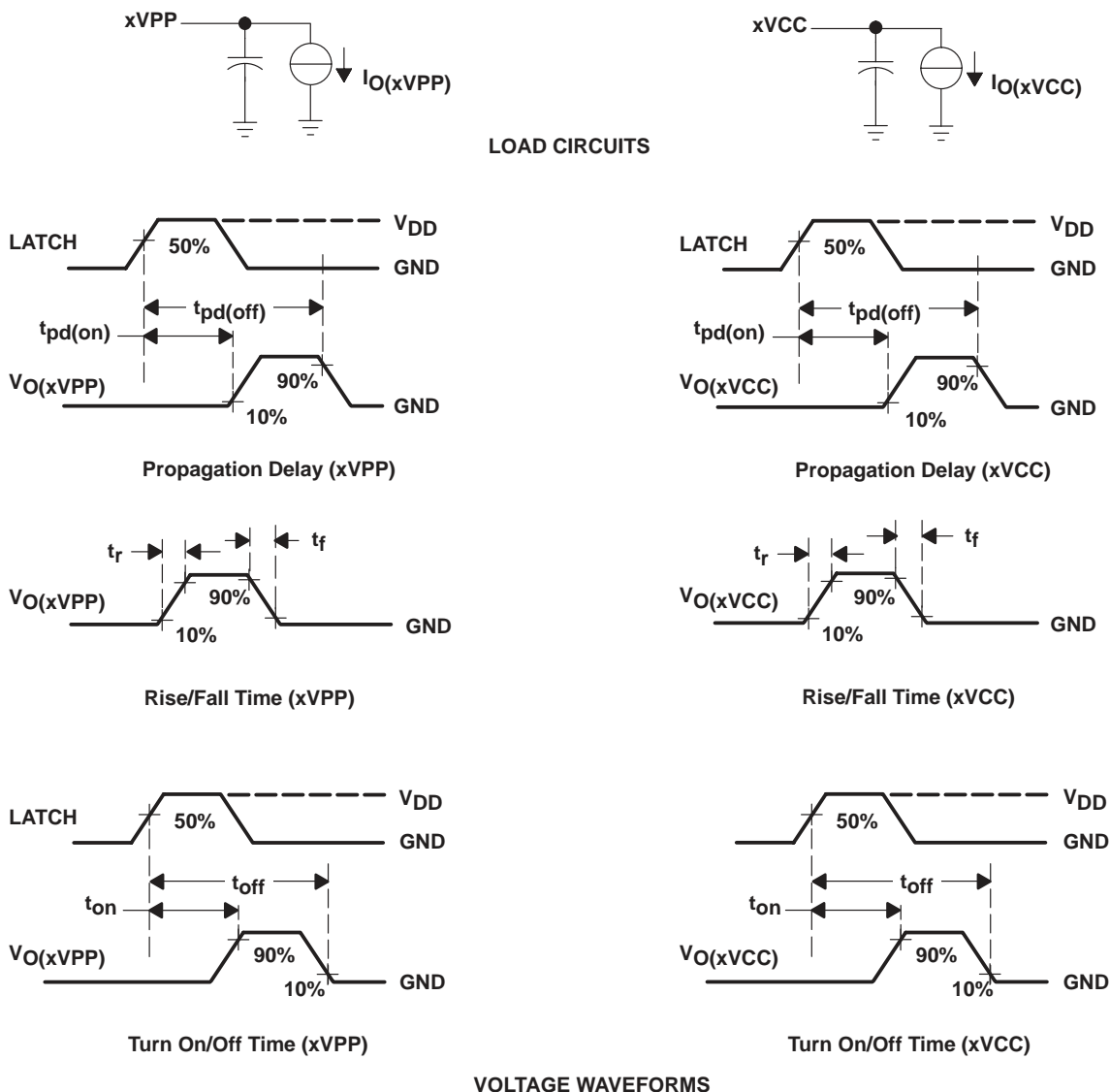
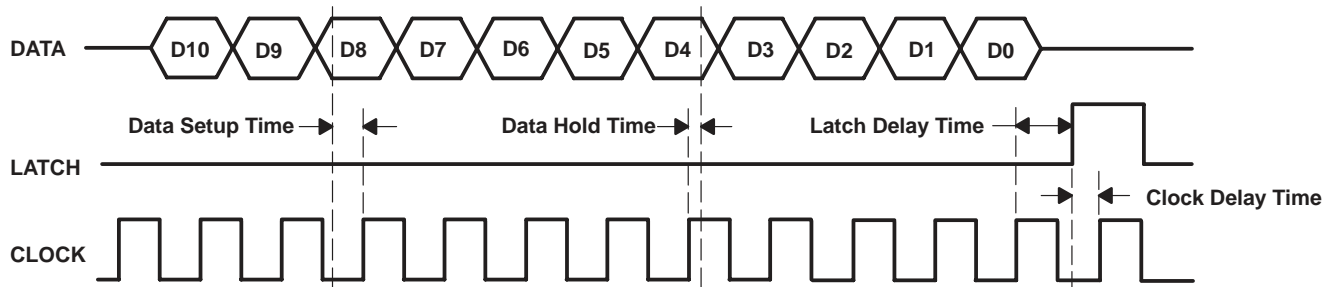

Figure 1. Test Circuits and Voltage Waveforms

PARAMETER MEASUREMENT INFORMATION



NOTE: Data is clocked in on the positive edge of the clock. The positive edge of the latch signal should occur before the next positive edge of the clock. For definition of D0 to D10, see the control logic table.

Figure 2. Serial-Interface Timing for Independent xVPP Switching When MODE = 5 V or 3.3 V

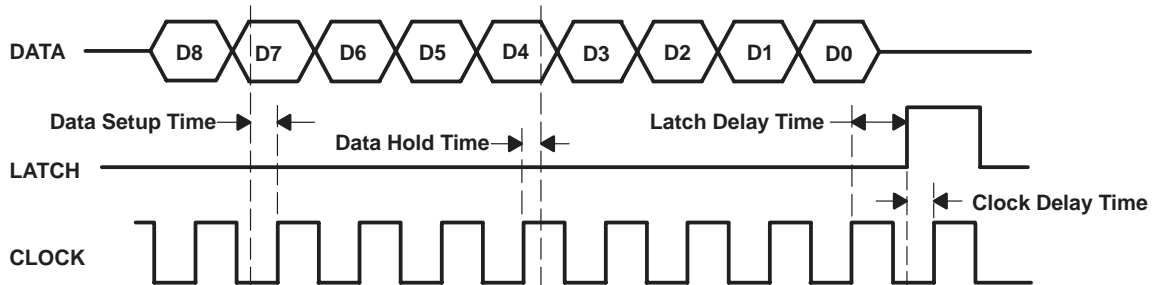

NOTE: Data is clocked in on the positive edge of the clock. The positive edge of the latch signal should occur before the next positive edge of the clock. For definition of D0 to D8, see the control logic table.

Figure 3. Serial-Interface Timing When MODE = 0 V or Floating

Table of Timing Diagrams†

| | FIGURE |
|---|--------|
| Short-circuit current response, short applied to powered-on 5-V xVCC switch output | 4 |
| Short-circuit current response, short applied to powered-on 12-V xVPP switch output | 5 |
| OC response with ramped load on 5-V xVCC switch output | 6 |
| OC response with ramped load on 12-V xVPP switch output | 7 |

† Timing tests are conducted at free-air temperature, $V_I(5V) = 5V$, $V_I(3.3V) = 3.3V$, $V_I(12V) = 12V$, $C_L = 0.1\mu F$ on each output, \overline{STBY} floating.

TPS2214A, TPS2216A
DUAL-SLOT PC CARD POWER SWITCHES
FOR SERIAL PCMCIA CONTROLLERS

SLVS267C – DECEMBER 1999 – REVISED FEBRUARU 2008

PARAMETER MEASUREMENT INFORMATION

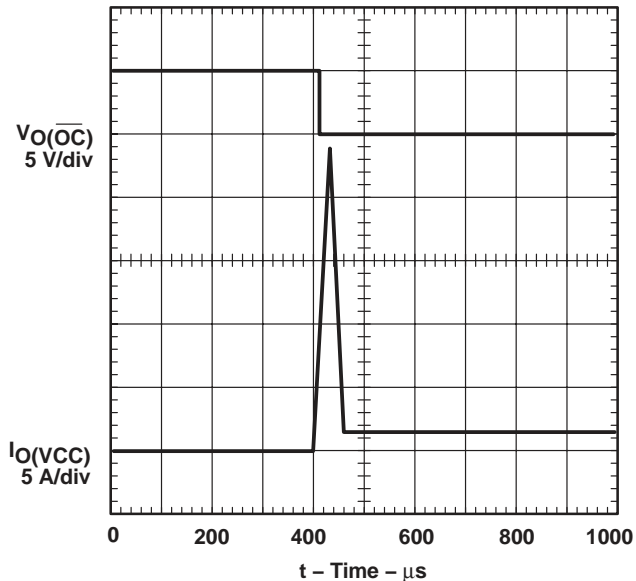

Figure 4. Short-Circuit Response, Short Applied to Powered-on 5-V xVCC-Switch Output

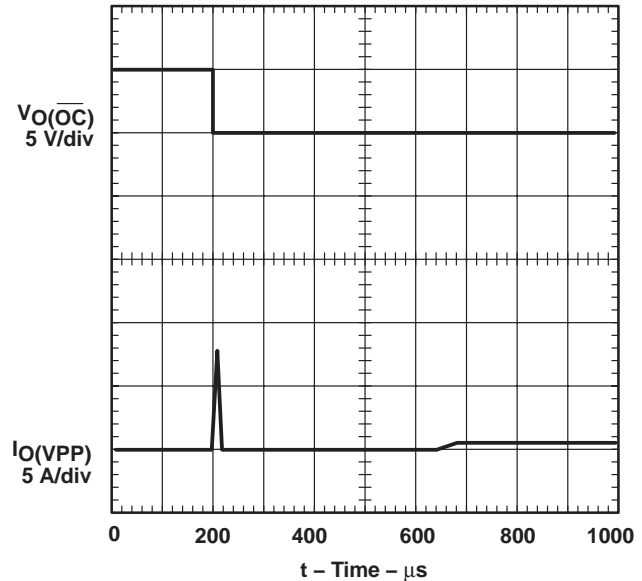

Figure 5. Short-Circuit Response, Short Applied to Powered-on 12-V xVPP-Switch Output

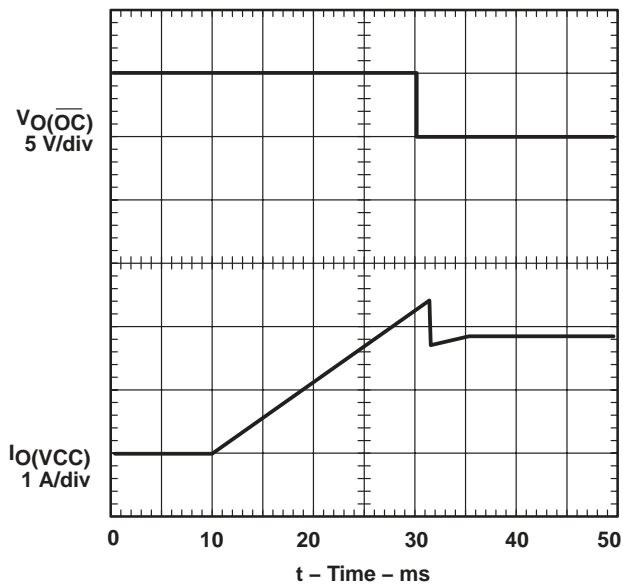

Figure 6. \overline{OC} Response With Ramped Load on 5-V xVCC-Switch Output

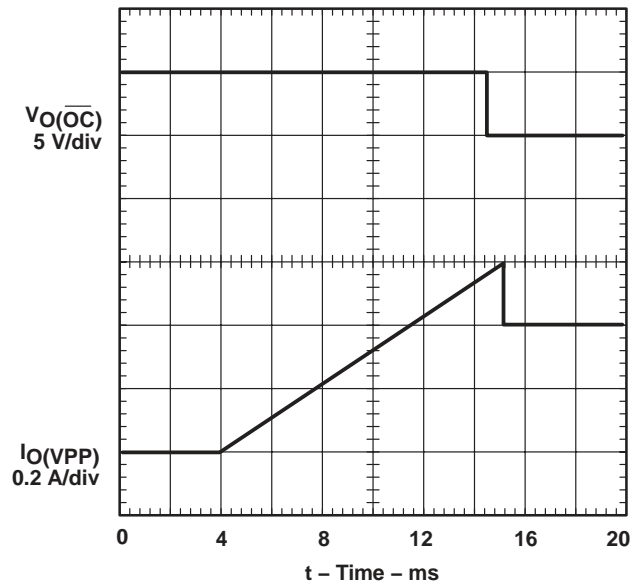

Figure 7. \overline{OC} Response With Ramped Load on 12-V xVPP-Switch Output

TPS2214A, TPS2216A
DUAL-SLOT PC CARD POWER SWITCHES
FOR SERIAL PCMCIA CONTROLLERS

SLVS267C – DECEMBER 1999 – REVISED FEBRUARU 2008

TYPICAL CHARACTERISTICS

Table of Graphs

| | | | FIGURE |
|----------------|---|-------------------------|--------|
| $t_{pd(on)}$ | Turnon propagation delay time, 3.3-V xVCC switch | vs Load capacitance | 8 |
| $t_{pd(off)}$ | Turnoff propagation delay time, 3.3-V xVCC switch | vs Load capacitance | 9 |
| $t_{pd(on)}$ | Turnon propagation delay time, 5-V xVCC switch | vs Load capacitance | 10 |
| $t_{pd(off)}$ | Turnoff propagation delay time, 5-V xVCC switch | vs Load capacitance | 11 |
| $t_{pd(on)}$ | Turnon propagation delay time, 12-V xVPP switch | vs Load capacitance | 12 |
| $t_{pd(off)}$ | Turnoff propagation delay time dc, 12-V xVPP switch | vs Load capacitance | 13 |
| t_r | Rise time, 3.3-V xVCC switch | vs Load capacitance | 14 |
| t_f | Fall time, 3.3-V xVCC switch | vs Load capacitance | 15 |
| t_r | Rise time, 5-V xVCC switch | vs Load capacitance | 16 |
| t_f | Fall time, 5-V xVCC switch | vs Load capacitance | 17 |
| t_r | Rise time, 12-V xVPP switch | vs Load capacitance | 18 |
| t_f | Fall time, 12-V xVPP switch | vs Load capacitance | 19 |
| I_I | Input current at $V_I(xVCC) = V_I(xVPP) = 3.3\text{ V}$ | vs Junction temperature | 20 |
| | Input current at $V_I(xVCC) = V_I(xVPP) = 5\text{ V}$ | vs Junction temperature | 21 |
| | Input current at $V_I(xVCC) = 5\text{ V}$, $V_I(xVPP) = 12\text{ V}$ | vs Junction temperature | 22 |
| $r_{DS(on)}$ | Static drain-source on-state resistance, 3.3-V xVCC switch | vs Junction temperature | 23 |
| | Static drain-source on-state resistance, 5-V xVCC switch | vs Junction temperature | 24 |
| | Static drain-source on-state resistance, 12-V xVPP switch | vs Junction temperature | 25 |
| $V_{IO(xVCC)}$ | DC input-to-output voltage (drop), 3.3-V xVCC switch | vs Load current | 26 |
| | DC input-to-output voltage (drop), 5-V xVCC switch | vs Load current | 27 |
| $V_{IO(xVPP)}$ | DC input-to-output voltage (drop), 12-V xVPP switch | vs Load current | 28 |
| I_{OS} | Short-circuit current limit, 3.3-V xVCC switch | vs Junction temperature | 29 |
| | Short-circuit current limit, 5-V xVCC switch | vs Junction temperature | 30 |
| | Short-circuit current limit, 12-V xVPP switch | vs Junction temperature | 31 |

NOTE: Electrical characteristics tests are conducted at $V_I(5V) = 5\text{ V}$, $V_I(3.3V) = 3.3\text{ V}$, $V_I(12V) = 12\text{ V}$, $C_L = 0.1\text{ }\mu\text{F}$ on each output, $\overline{\text{STBY}}$ floating (unless otherwise noted on Figures).

**TPS2214A, TPS2216A
DUAL-SLOT PC CARD POWER SWITCHES
FOR SERIAL PCMCIA CONTROLLERS**

SLVS267C – DECEMBER 1999 – REVISED FEBRUARU 2008

TYPICAL CHARACTERISTICS

**TURNON PROPAGATION DELAY TIME,
3.3-V xVCC SWITCH
vs
LOAD CAPACITANCE**

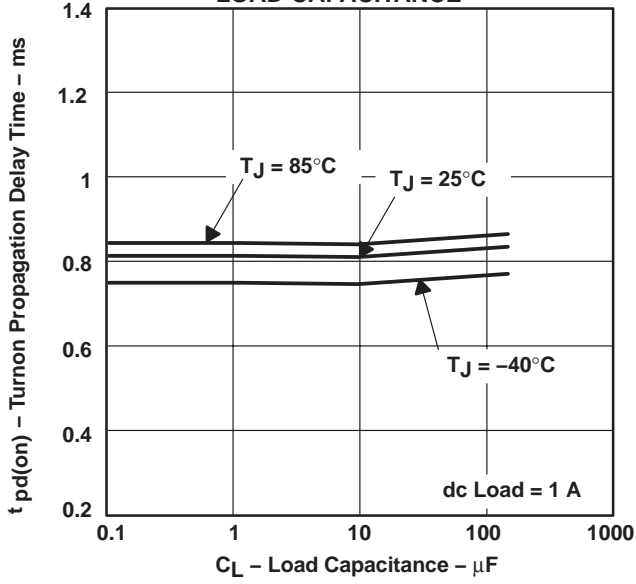

Figure 8

**TURNOFF PROPAGATION DELAY TIME,
3.3-V xVCC SWITCH
vs
LOAD CAPACITANCE**

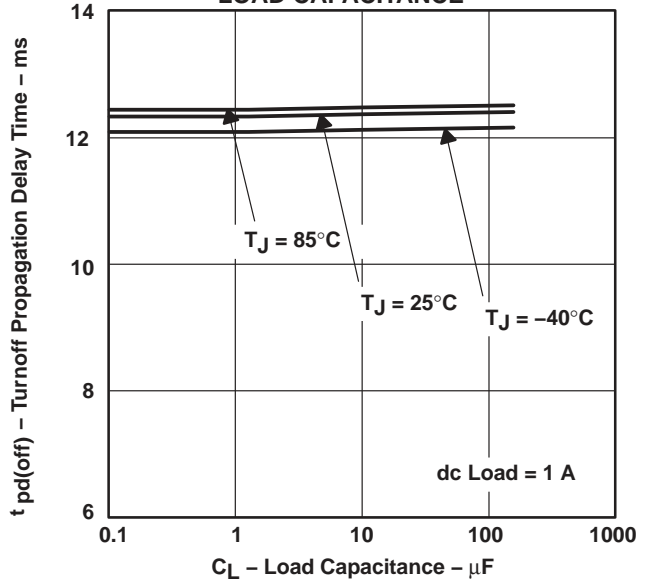

Figure 9

**TURNON PROPAGATION DELAY TIME,
5-V xVCC SWITCH
vs
LOAD CAPACITANCE**

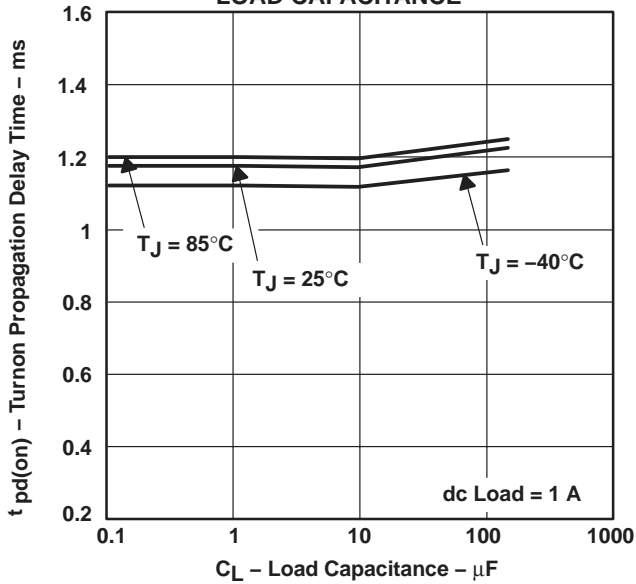

Figure 10

**TURNOFF PROPAGATION DELAY TIME,
5-V xVCC SWITCH
vs
LOAD CAPACITANCE**

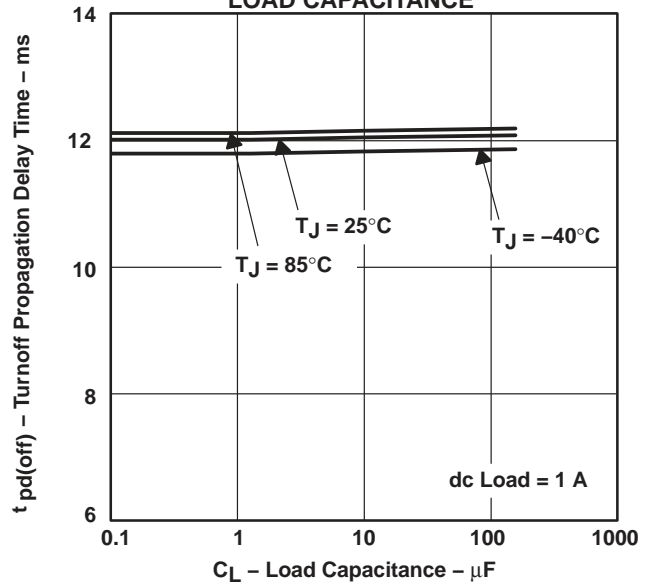

Figure 11



TYPICAL CHARACTERISTICS

TURNON PROPAGATION DELAY TIME,
 12-V xVPP SWITCH
 VS
 LOAD CAPACITANCE

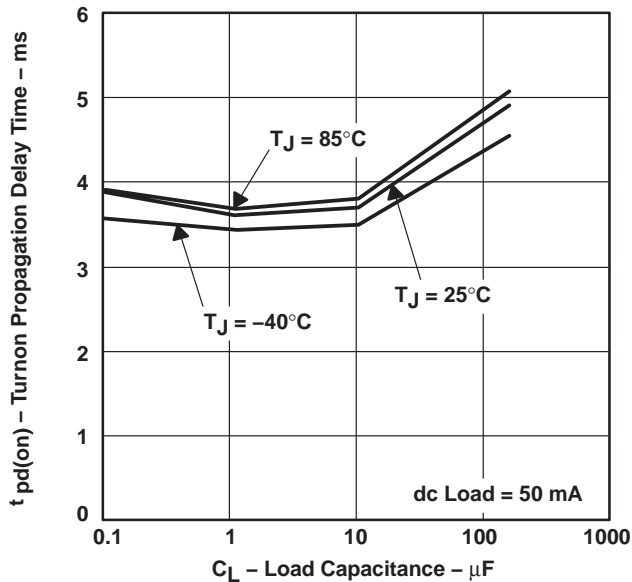

Figure 12

TURNOFF PROPAGATION DELAY TIME dc
 12-V xVPP SWITCH
 VS
 LOAD CAPACITANCE

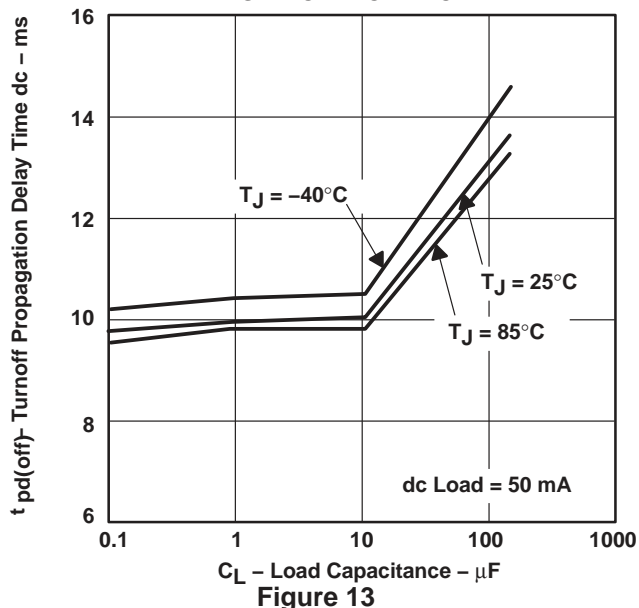

Figure 13

RISE TIME, 3.3-V xVCC SWITCH
 VS
 LOAD CAPACITANCE

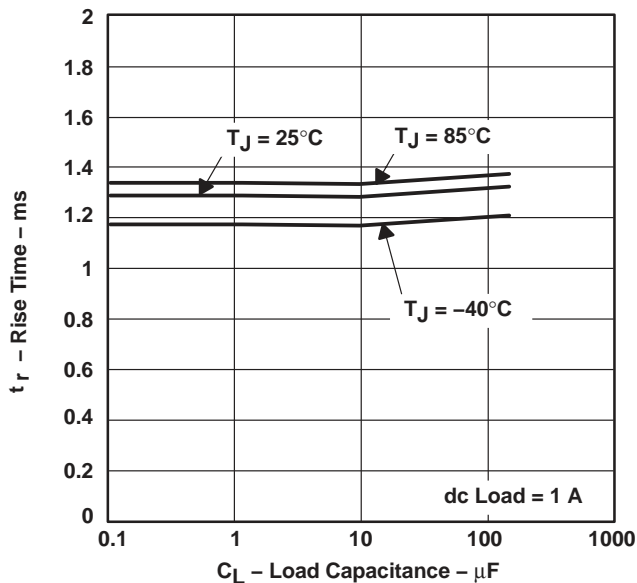

Figure 14

FALL TIME, 3.3-V xVCC SWITCH
 VS
 LOAD CAPACITANCE

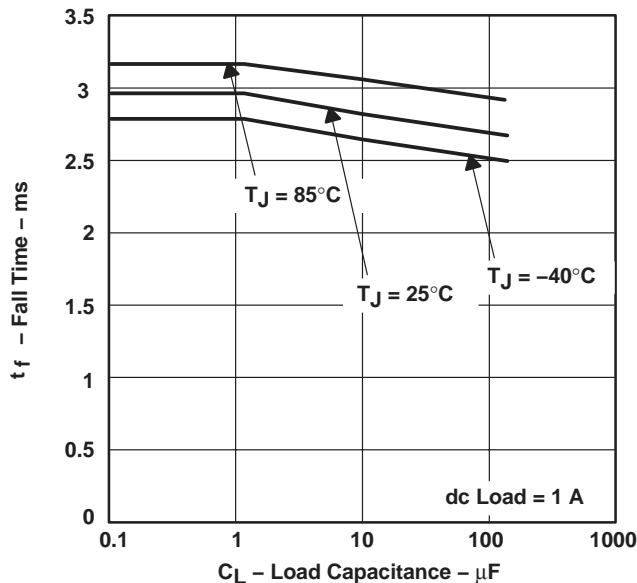

Figure 15

TPS2214A, TPS2216A
DUAL-SLOT PC CARD POWER SWITCHES
FOR SERIAL PCMCIA CONTROLLERS

SLVS267C – DECEMBER 1999 – REVISED FEBRUARU 2008

TYPICAL CHARACTERISTICS

RISE TIME, 5-V xVCC SWITCH
vs
LOAD CAPACITANCE

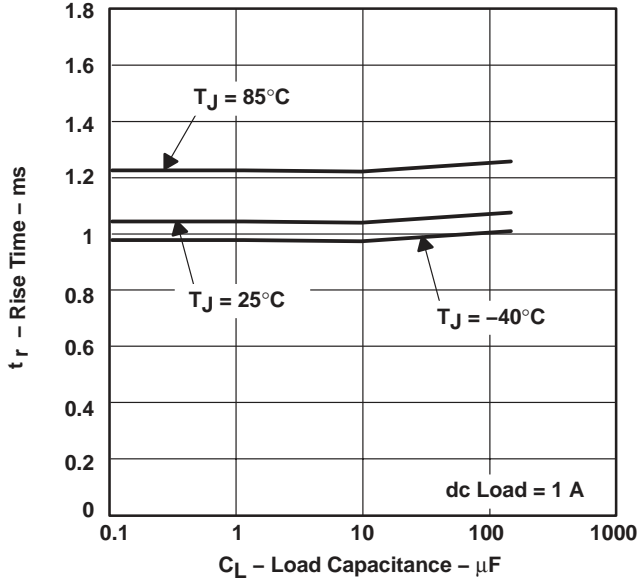

Figure 16

FALL TIME, 5-V xVCC SWITCH
vs
LOAD CAPACITANCE

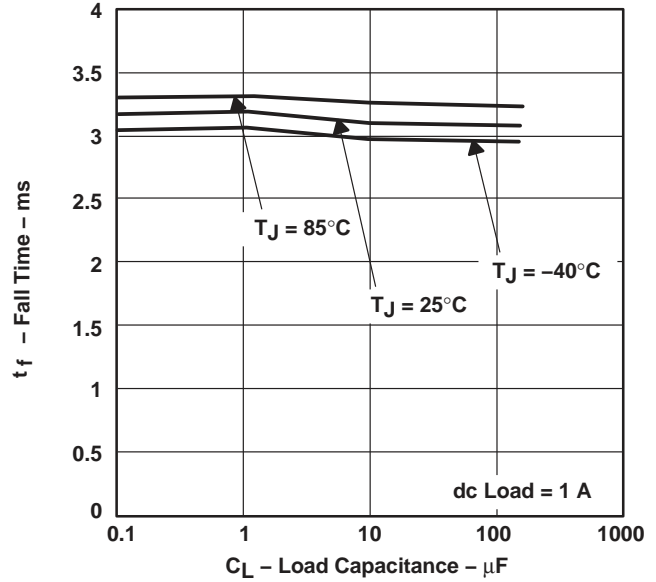

Figure 17

RISE TIME, 12-V xVPP SWITCH
vs
LOAD CAPACITANCE

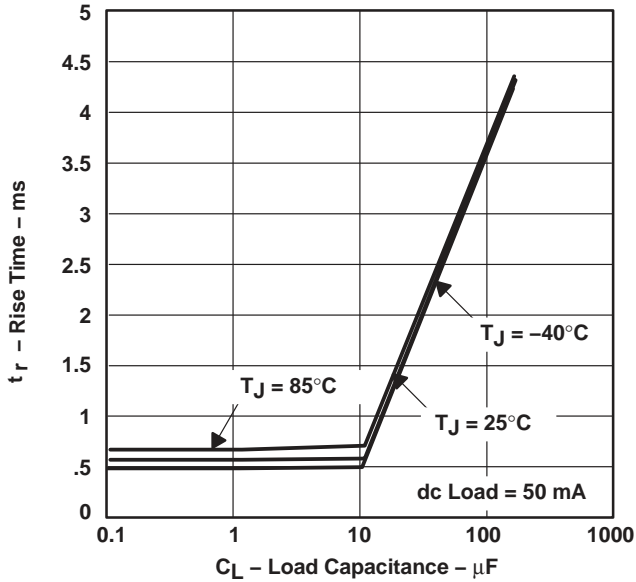

Figure 18

FALL TIME, 12-V xVPP SWITCH
vs
LOAD CAPACITANCE

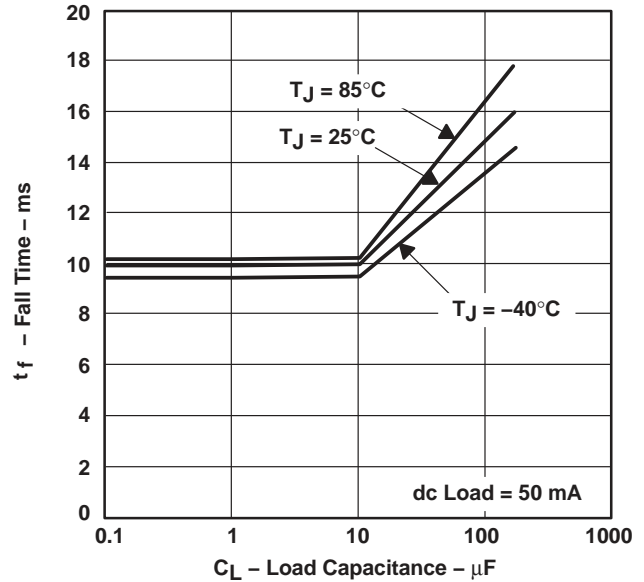

Figure 19



TYPICAL CHARACTERISTICS

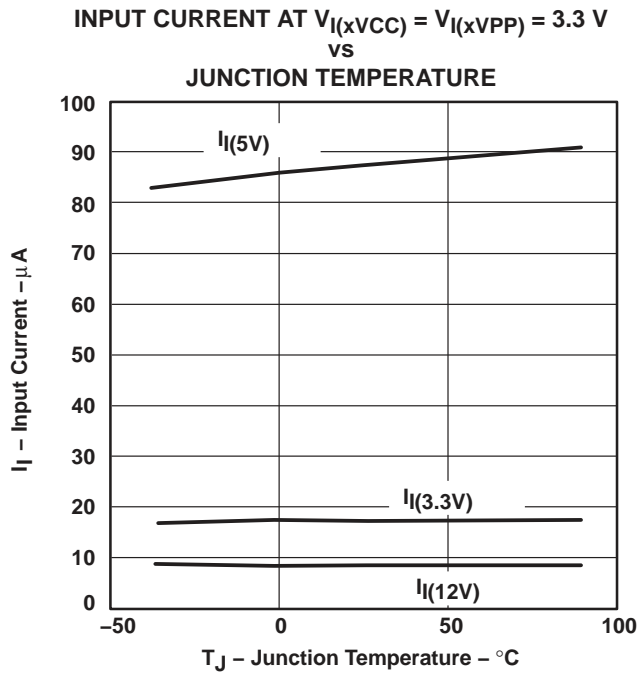

Figure 20

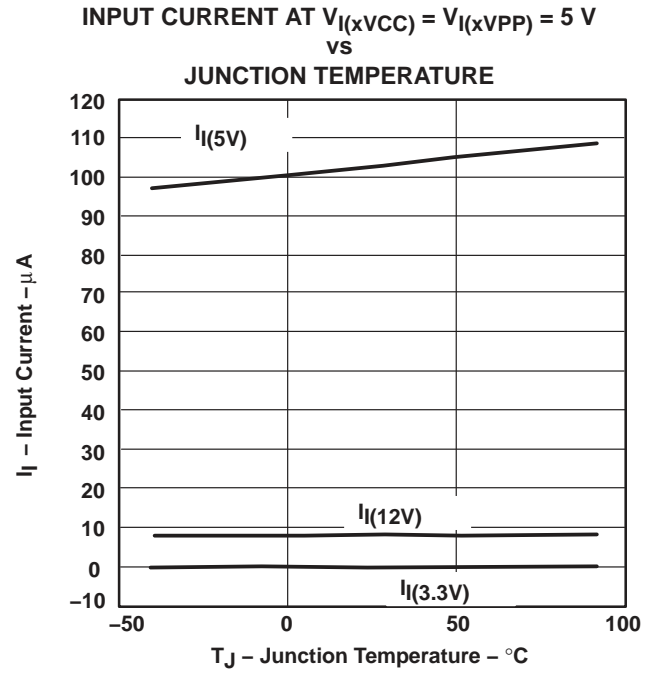

Figure 21

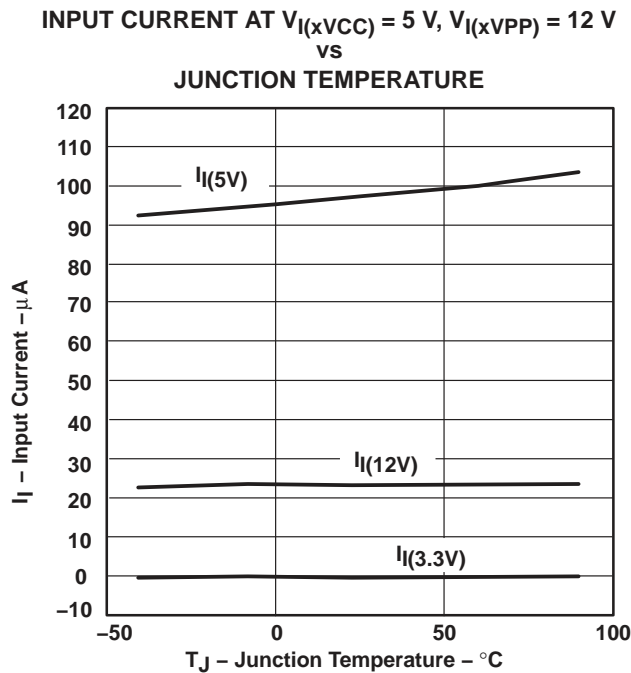

Figure 22

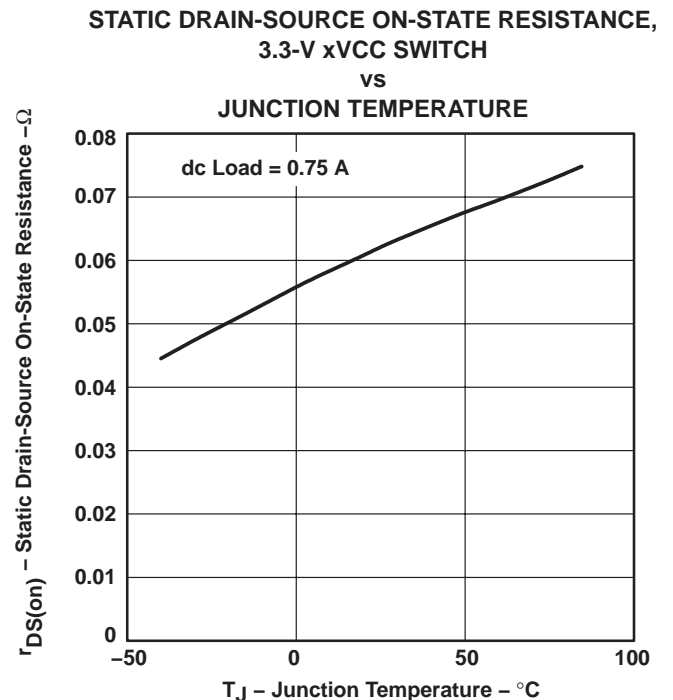

Figure 23

TPS2214A, TPS2216A
DUAL-SLOT PC CARD POWER SWITCHES
FOR SERIAL PCMCIA CONTROLLERS

SLVS267C – DECEMBER 1999 – REVISED FEBRUARU 2008

TYPICAL CHARACTERISTICS

**STATIC DRAIN-SOURCE ON-STATE RESISTANCE,
 5-V xVCC SWITCH**

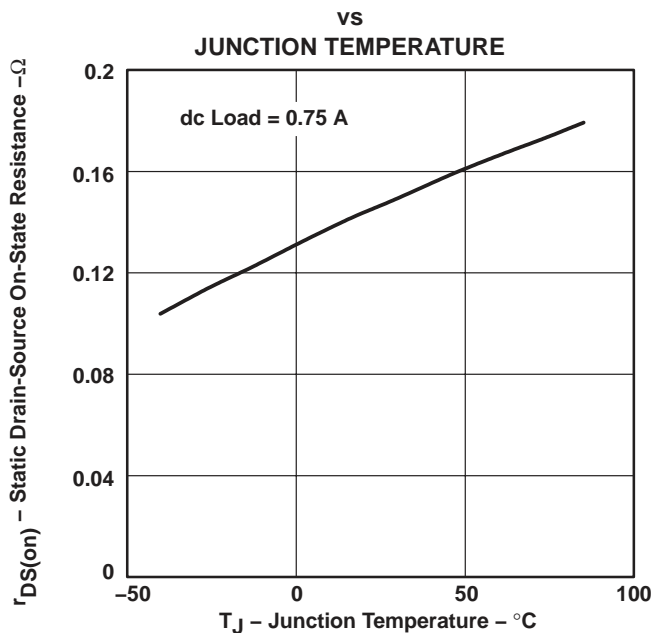

Figure 24

**STATIC DRAIN-SOURCE ON-STATE RESISTANCE,
 12-V xVPP SWITCH**

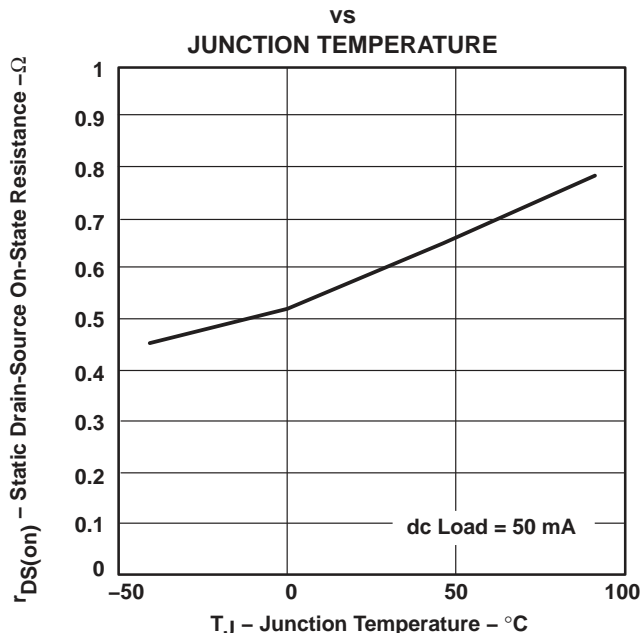

Figure 25

**DC INPUT-TO-OUTPUT VOLTAGE (DROP),
 3.3-V xVCC SWITCH**

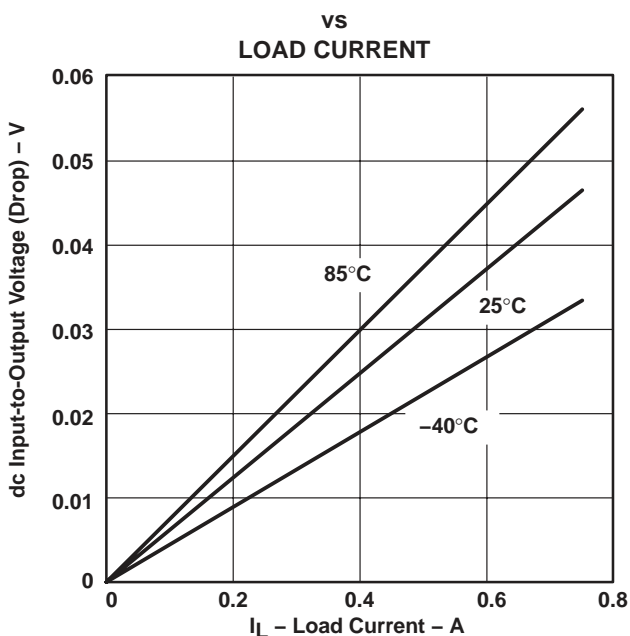

Figure 26

**DC INPUT-TO-OUTPUT VOLTAGE (DROP),
 5-V xVCC SWITCH**

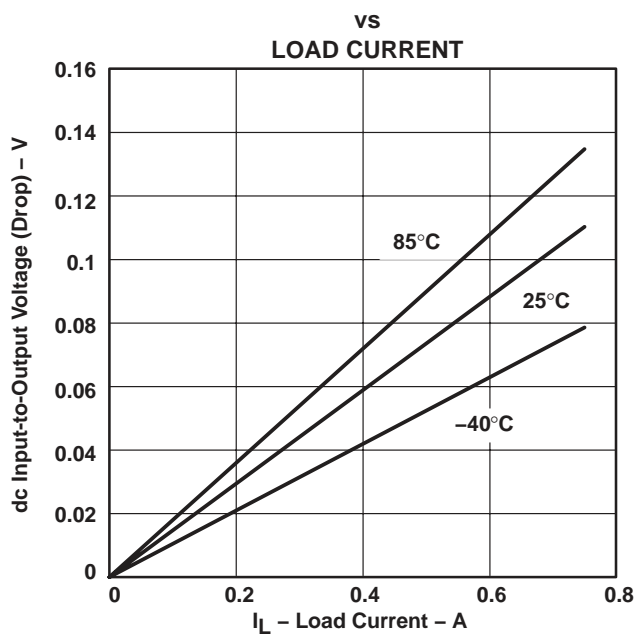

Figure 27



TYPICAL CHARACTERISTICS

DC INPUT-TO-OUTPUT VOLTAGE (DROP),
 12-V xVPP SWITCH
 vs
 LOAD CURRENT

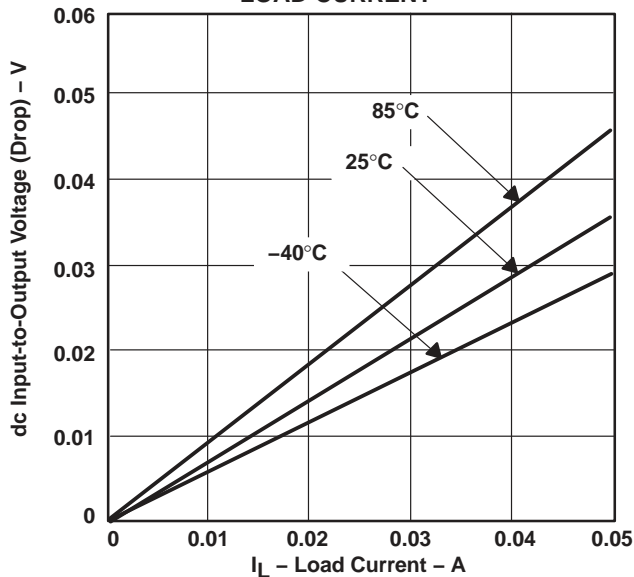

Figure 28

SHORT-CIRCUIT CURRENT LIMIT,
 3.3-V xVCC SWITCH
 vs
 JUNCTION TEMPERATURE

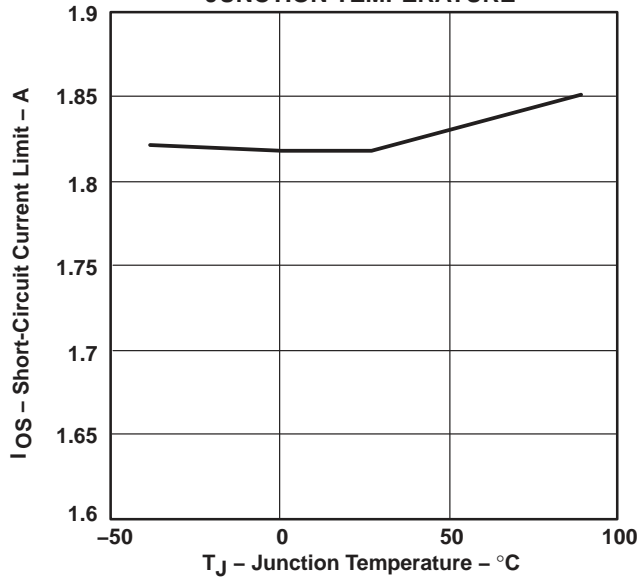

Figure 29

SHORT-CIRCUIT CURRENT LIMIT, 5-V xVCC
 SWITCH
 vs
 JUNCTION TEMPERATURE

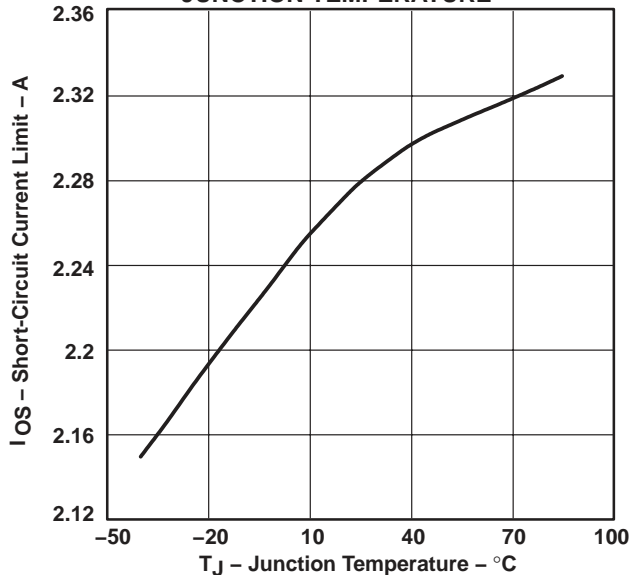

Figure 30

SHORT-CIRCUIT CURRENT LIMIT, 12-V xVPP
 SWITCH
 vs
 JUNCTION TEMPERATURE

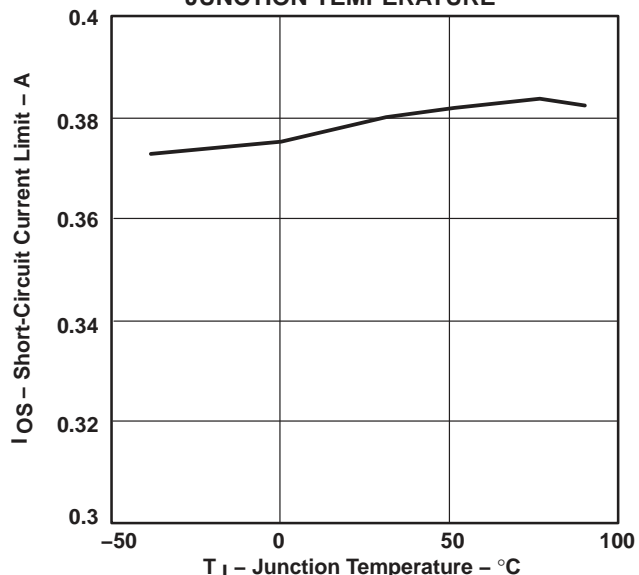

Figure 31

TPS2214A, TPS2216A DUAL-SLOT PC CARD POWER SWITCHES FOR SERIAL PCMCIA CONTROLLERS

SLVS267C – DECEMBER 1999 – REVISED FEBRUARU 2008

APPLICATION INFORMATION

overview

PC Cards were initially introduced as a means to add EEPROM (flash memory) to portable computers with limited onboard memory. The idea of add-in cards quickly took hold; modems, wireless LANs, Global Positioning Satellite System (GPS), multimedia, and hard-disk versions were soon available. As the number of PC Card applications grew, the engineering community quickly recognized the need for a standard to ensure compatibility across platforms. To this end, the PCMCIA (Personal Computer Memory Card International Association), comprising members from leading computer, software, PC Card, and semiconductor manufacturers, was established. One key goal was to realize the plug-and-play concept. Cards and hosts from different vendors should be compatible or able to communicate with one another transparently.

PC Card power specification

System compatibility also means power compatibility. The most current set of specifications (PC Card Standard) set forth by the PCMCIA committee states that power is to be transferred between the host and the card through eight of the 68 terminals of the PC Card connector. This power interface consists of two V_{CC} , two V_{pp} , and four ground terminals. Multiple V_{CC} and ground terminals minimize connector terminal and line resistance. The two V_{pp} terminals were originally specified as separate signals, but are commonly tied together in the host to form a single node to minimize voltage losses. Card primary power is supplied through the V_{CC} terminals; flash-memory programming and erase voltage is supplied through the V_{pp} terminals.

designing for voltage regulation

The current PCMCIA specification for output voltage regulation, $V_{O(reg)}$, of the 5-V output is 5% (250 mV). In a typical PC power-system design, the power supply has an output-voltage regulation, $V_{PS(reg)}$, of 2% (100 mV). Also, a voltage drop from the power supply to the PC Card will result from resistive losses, V_{PCB} , in the PCB traces and the PCMCIA connector. A typical design would limit the total of these resistive losses to less than 1% (50 mV) of the output voltage. Therefore, the allowable voltage drop, V_{DS} , for the TPS2214A or TPS2216A would be the PCMCIA voltage regulation less the power supply regulation and less the PCB and connector resistive drops:

$$V_{DS} = V_{O(reg)} - V_{PS(reg)} - V_{PCB}$$

Typically, this would leave 100 mV for the allowable voltage drop across the 5-V switch. The specification for output voltage regulation of the 3.3-V output is 300 mV; so, using the same equation by deducting the voltage drop percentages (2%) for power-supply regulation and PCB resistive loss (1%), the allowable voltage drop for the 3.3-V switch is 200 mV. The voltage drop is the output current multiplied by the switch resistance of the TPS2214A or TPS2216A. Therefore, the maximum output current, I_{Omax} , that can be delivered to the PC Card in regulation is the allowable voltage drop across the IC, divided by the output-switch resistance.

$$I_{Omax} = \frac{V_{DS}}{r_{DS(on)}}$$

The xVCC outputs can deliver 1 A continuously at 5 V and 3.3 V within regulation over the operating temperature range. The xVPP outputs of the IC can deliver 200 mA continuously.

APPLICATION INFORMATION

designing for voltage regulation (continued)

overcurrent and overtemperature protection

PC Cards are inherently subject to damage that can result from mishandling. Host systems require protection against short-circuited cards that could lead to power-supply or PCB trace damage. Even systems robust enough to withstand a short circuit would still undergo rapid battery discharge into the damaged PC Card, resulting in the rather sudden and unacceptable loss of system power. Most hosts include fuses for protection. However, the reliability of fused systems is poor, as blown fuses require troubleshooting and repair, usually by the manufacturer.

The TPS2214A and TPS2216A take a two-pronged approach to overcurrent protection, which is designed to activate if an output is shorted or when an overcurrent condition is present when switches are powered up. First, instead of fuses, sense FETs monitor each of the xVCC and xVPP power outputs. Unlike sense resistors or polyfuses, these FETs do not add to the series resistance of the switch; therefore voltage and power losses are reduced. Overcurrent sensing is applied to each output separately. Excessive current generates an error signal that limits the output current of only the affected output, preventing damage to the host. Each xVCC output overcurrent limits from 1 A to 2.2 A, typically around 1.6 A; the xVPP outputs limit from 250 mA to 500 mA, typically around 375 mA.

Second, when an overcurrent condition is detected, these devices assert an active low \overline{OC} signal that can be monitored by the microprocessor or controller to initiate diagnostics and/or send the user a warning message. In the event that an overcurrent condition persists, causing the IC to exceed its maximum junction temperature, thermal-protection circuitry activates. This shuts down all power outputs until the device cools to within a safe operating region, which is ensured by a thermal shutdown hysteresis.

12-V supply not required

Many PC Card switches use the externally supplied 12 V to power gate drive and other chip functions; this requires that power be present at all times. The TPS2214A and TPS2216A offer considerable power savings by using an internal charge pump to generate the required higher gate drive voltages from the 5-V or 3.3-V power supplies. Therefore, the external 12-V supply can be disabled except when needed for flash-memory functions, thereby extending battery lifetime. Additional power savings are realized by the IC during shutdown mode, in which quiescent current drops to a maximum of 1 μ A.

3.3-V low-voltage mode

The TPS2214A and TPS2216A will operate in 3.3-V low-voltage mode when 3.3 V is the only available input voltage ($V_{I(5V)} = 0$, $V_{I(12V)} = 0$). This feature allows host and PC Cards to be operated in low-power 3.3-V-only modes such as sleep modes. Note that in this operation mode, the IC will derive its bias current from the 3.3-V input pin and can only provide 3.3 V to the outputs.

voltage transitioning requirement

PC Cards are migrating from 5 V to 3.3 V to minimize power consumption, optimize board space, and increase logic speeds. The TPS2214A and TPS2216A meet all combinations of power delivery as currently defined in the PCMCIA standard. The latest protocol accommodates mixed 3.3-V/5-V systems by first powering the card with 5 V, then polling it to determine its 3.3-V compatibility. The PCMCIA specification requires that the capacitors on 3.3-V-compatible cards be discharged to below 0.8 V before applying 3.3-V power. This action ensures that sensitive 3.3-V circuitry is not subjected to any residual 5-V charge and functions as a power reset. PC Card specification requires that V_{CC} be discharged within 100 ms. PC Card resistance can not be relied on to provide a discharge path for voltages stored on PC Card capacitance because of possible high-impedance isolation by power-management schemes. The TPS2214A and TPS2216A include discharge transistors on all xVCC and xVPP outputs to meet the specification requirement.

TPS2214A, TPS2216A DUAL-SLOT PC CARD POWER SWITCHES FOR SERIAL PCMCIA CONTROLLERS

SLVS267C – DECEMBER 1999 – REVISED FEBRUARU 2008

APPLICATION INFORMATION

designing for voltage regulation (continued)

shutdown mode

In the shutdown mode, which can be controlled by bit D8 of the input serial DATA word, each of the xVCC and xVPP outputs is forced to a high-impedance state. In this mode, the chip quiescent current is limited to 1 μ A or less to conserve battery power.

standby mode

The TPS2214A and TPS2216A can be put in standby mode by pulling $\overline{\text{STBY}}$ low to conserve power during low-power operation. In this mode, all of the power outputs (xVCC and xVPP) will have a nominal current limit of 50 mA. $\overline{\text{STBY}}$ has an internal 150-k Ω pullup resistor. The output-switch status of the device must be set, allowing the output capacitors to charge, prior to enabling the standby mode. Changing the setting of the output switches with the device in standby mode may cause an overcurrent response to be generated.

mode

The mode pin programs the switches in either TPS2214A/TPS2216A or TPS2206 mode. An internal 150-k Ω pulldown resistor is connected to the pin. Floating or pulling the mode pin low sets the switches in TPS2206 mode; pulling the mode pin high sets the switches in TPS2214A/TPS2216A mode. In TPS2206 mode, xVPP outputs are dependent on xVCC outputs. In TPS2214A/TPS2216A mode, xVPP is programmed independent of xVCC. Refer to TPS2214A/TPS2216A control-logic tables for more information.

power-supply considerations

The TPS2214A and TPS2216A have multiple pins for each of its 3.3-V and 5-V power inputs and for the switched xVCC outputs. Any individual pin can conduct the rated input or output current. Unless all pins are connected in parallel, the series resistance is higher than that specified, resulting in increased voltage drops and less power. It is recommended that all input and output power pins be paralleled for optimum operation. Because the two 12-V pins are not internally connected, they must be tied together externally.

To increase the noise immunity of the TPS2214A and TPS2216A, the power-supply inputs should be bypassed with a 1- μ F electrolytic or tantalum capacitor paralleled by a 0.047- μ F to 0.1- μ F ceramic capacitor. It is strongly recommended that the switched outputs be bypassed with a 0.1- μ F (or larger) ceramic capacitor; doing so improves the immunity of the IC to electrostatic discharge (ESD). Care should be taken to minimize the inductance of PCB traces between the IC and the load. High switching currents can produce large negative voltage transients, which forward biases substrate diodes, resulting in unpredictable performance. Similarly, no pin should be taken, or allowed to fall, below -0.3 V.

RESET and $\overline{\text{RESET}}$ inputs

To ensure that cards are in a known state after power brownouts or system initialization, the PC Cards should be reset at the same time as the host by applying low impedance paths from xVCC and xVPP terminals to ground. A low-impedance output state allows discharging of residual voltage remaining on PC Card filter capacitance, permitting the system (host and PC Cards) to be powered up concurrently. The active-high RESET or active low $\overline{\text{RESET}}$ input will close internal switches S1, S4, S7, and S11 with all other switches left open. The TPS2214A and TPS2216A remain in the low-impedance output state until the signal is deasserted and further data is clocked in and latched. The input serial data can not be latched during reset mode. RESET and $\overline{\text{RESET}}$ are provided for direct compatibility with systems that use either an active-low or active-high reset voltage supervisor. The RESET pin has an internal 150-k Ω pulldown resistor and the $\overline{\text{RESET}}$ pin has an internal 150-k Ω pullup resistor. The device will be reset automatically when powered up.



APPLICATION INFORMATION

calculating junction temperature

The switch resistance, $r_{DS(on)}$, is dependent on the junction temperature, T_J , of the die. The junction temperature is dependent on both $r_{DS(on)}$ and the current through the switch. To calculate T_J , first find $r_{DS(on)}$ from Figures 23 through 25, using an initial temperature estimate about 50°C above ambient. Then calculate the power dissipation for each switch, using the formula:

$$P_D = r_{DS(on)} \times I^2$$

Next, sum the power dissipation of all switches and calculate the junction temperature:

$$T_J = \left(\sum P_D \times R_{\theta JA} \right) + T_A$$

Where:

$R_{\theta JA}$ is the inverse of the derating factor given in the dissipation rating table.

Compare the calculated junction temperature with the initial temperature estimate. If the temperatures are not within a few degrees of each other, recalculate using the calculated temperature as the initial estimate.

logic inputs and outputs

The serial interface consists of DATA, CLOCK, and LATCH leads. The data is clocked in on the positive edge of the clock (see Figures 2 and 3). The 11-bit (D0–D10) serial data word is loaded during the positive edge of the latch signal. The positive edge of the latch signal should occur before the next positive edge of the clock occurs.

The TPS2216 serial interfaces are compatible with serial-interface PCMCIA controllers and current PCMCIA and Japan Electronic Industry Development Association (JEIDA) standards.

An overcurrent output (\overline{OC}) is provided to indicate an overcurrent or overtemperature condition in any of the xVCC and xVPP outputs as previously discussed.

**TPS2214A, TPS2216A
DUAL-SLOT PC CARD POWER SWITCHES
FOR SERIAL PCMCIA CONTROLLERS**

SLVS267C – DECEMBER 1999 – REVISED FEBRUARU 2008

APPLICATION INFORMATION

TPS2214A/TPS2216A control logic

TPS2214A/TPS2216A mode (MODE pulled high)

xVPP

| D8 (SHDN) | AVPP CONTROL SIGNALS | | | OUTPUT V_AVPP | BVPP CONTROL SIGNALS | | | | OUTPUT V_BVPP |
|-----------|----------------------|----|----|------------------|----------------------|----|----|-----|------------------|
| | D0 | D1 | D9 | | D8 (SHDN) | D4 | D5 | D10 | |
| 1 | 0 | 0 | X | 0 V | 1 | 0 | 0 | X | 0 V |
| 1 | 0 | 1 | 0 | 3.3 V | 1 | 0 | 1 | 0 | 3.3 V |
| 1 | 0 | 1 | 1 | 5 V | 1 | 0 | 1 | 1 | 5 V |
| 1 | 1 | 0 | X | 12 V | 1 | 1 | 0 | X | 12 V |
| 1 | 1 | 1 | X | Hi-Z | 1 | 1 | 1 | X | Hi-Z |
| 0 | X | X | X | Hi-Z | 0 | X | X | X | Hi-Z |

xVCC

| D8 (SHDN) | AVCC CONTROL SIGNALS | | OUTPUT V_AVCC | BVCC CONTROL SIGNALS | | | OUTPUT V_BVCC |
|-----------|----------------------|----|------------------|----------------------|----|----|------------------|
| | D3 | D2 | | D8 (SHDN) | D6 | D7 | |
| 1 | 0 | 0 | 0 V | 1 | 0 | 0 | 0 V |
| 1 | 0 | 1 | 3.3 V | 1 | 0 | 1 | 3.3 V |
| 1 | 1 | 0 | 5 V | 1 | 1 | 0 | 5 V |
| 1 | 1 | 1 | 0 V | 1 | 1 | 1 | 0 V |
| 0 | X | X | Hi-Z | 0 | X | X | Hi-Z |

TPS2206 mode (MODE floating or pulled low)

xVPP

| D8 (SHDN) | AVPP CONTROL SIGNALS | | OUTPUT V_AVPP | BVPP CONTROL SIGNALS | | | OUTPUT V_BVPP |
|-----------|----------------------|----|------------------|----------------------|----|----|------------------|
| | D0 | D1 | | D8 (SHDN) | D4 | D5 | |
| 1 | 0 | 0 | 0 V | 1 | 0 | 0 | 0 V |
| 1 | 0 | 1 | V_AVCC | 1 | 0 | 1 | V_BVCC |
| 1 | 1 | 0 | 12 V | 1 | 1 | 0 | 12 V |
| 1 | 1 | 1 | Hi-Z | 1 | 1 | 1 | Hi-Z |
| 0 | X | X | Hi-Z | 0 | X | X | Hi-Z |

xVCC

| D8 (SHDN) | AVCC CONTROL SIGNALS | | OUTPUT V_AVCC | BVCC CONTROL SIGNALS | | | OUTPUT V_BVCC |
|-----------|----------------------|----|------------------|----------------------|----|----|------------------|
| | D3 | D2 | | D8 (SHDN) | D6 | D7 | |
| 1 | 0 | 0 | 0 V | 1 | 0 | 0 | 0 V |
| 1 | 0 | 1 | 3.3 V | 1 | 0 | 1 | 3.3 V |
| 1 | 1 | 0 | 5 V | 1 | 1 | 0 | 5 V |
| 1 | 1 | 1 | 0 V | 1 | 1 | 1 | 0 V |
| 0 | X | X | Hi-Z | 0 | X | X | Hi-Z |



APPLICATION INFORMATION

ESD protections (see Figure 32)

All TPS2214A and TPS2216A inputs and outputs incorporate ESD-protection circuitry designed to withstand a 2-kV human-body-model discharge as defined in MIL-STD-883C, Method 3015. The xVCC and xVPP outputs can be exposed to potentially higher discharges from the external environment through the PC Card connector. Bypassing the outputs with 0.1- μ F capacitors protects the devices from discharges up to 10 kV.

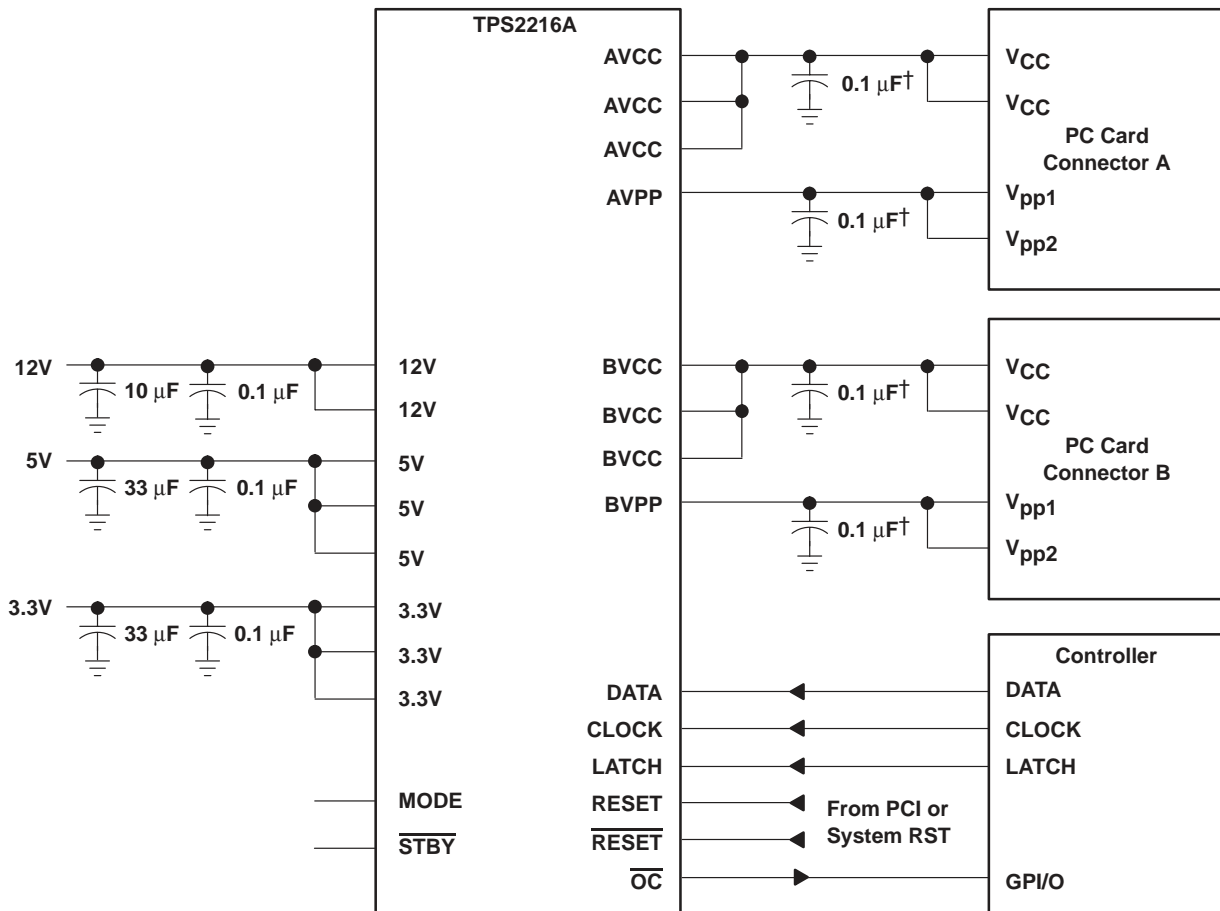

† Maximum recommended output capacitance for xVCC is 220 μ F and for xVPP is 10 μ F without $\overline{\text{OC}}$ glitch when switches are powered on.

Figure 32. Detailed Interconnections and Capacitor Recommendations

TPS2214A, TPS2216A DUAL-SLOT PC CARD POWER SWITCHES FOR SERIAL PCMCIA CONTROLLERS

SLVS267C – DECEMBER 1999 – REVISED FEBRUARU 2008

APPLICATION INFORMATION

12-V flash memory supply

The TPS6734 is a fixed 12-V output boost converter capable of delivering 120 mA from inputs as low as 2.7 V. The device is pin-for-pin compatible with the MAX734 regulator and offers the following advantages: lower supply current, wider operating input-voltage range, and higher output currents. As shown in Figure 33, the only external components required are: an inductor, a Schottky rectifier, an output filter capacitor, an input filter capacitor, and a small capacitor for loop compensation. The entire converter occupies less than 0.7 in² of PCB space when implemented with surface-mount components. An enable input is provided to shut the converter down and reduce the supply current to 3 μ A when 12 V is not needed.

The TPS6734 is a 170-kHz current-mode PWM (pulse-width modulation) controller with an n-channel MOSFET power switch. Gate drive for the switch is derived from the 12-V output after start-up to minimize the die area needed to realize the 0.7- Ω MOSFET and improve efficiency at input voltages below 5 V. Soft start is accomplished with the addition of one small capacitor. A 1.22-V reference (pin 2) is brought out for external use. For additional information, see the TPS6734 data sheet (SLVS127).

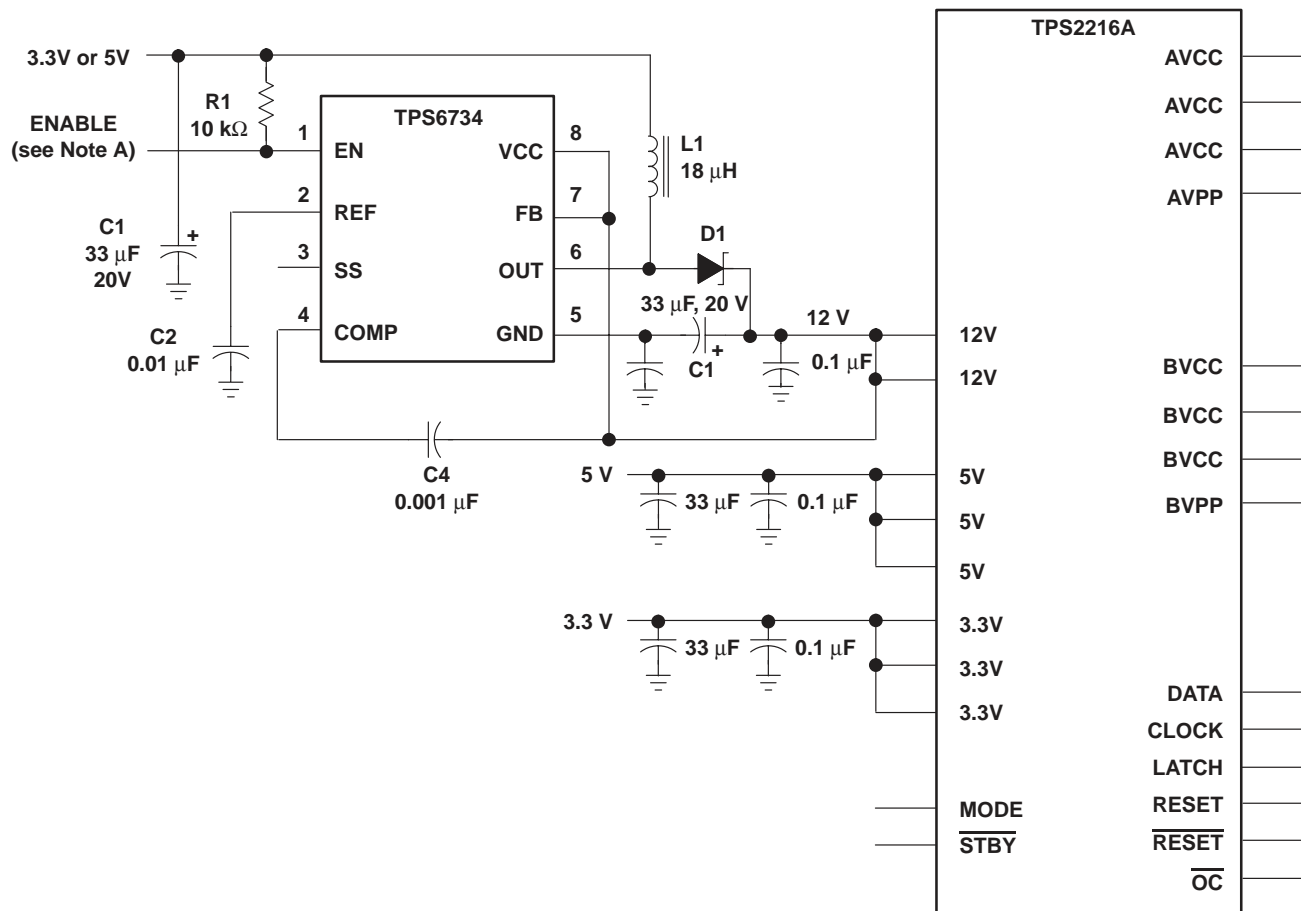

NOTE A: The enable terminal can be tied to a general-purpose I/O terminal on the PCMCIA controller or tied high.

Figure 33. TPS2216A with TPS6734 12-V, 120-mA Supply

PACKAGING INFORMATION

| Orderable Device | Status ⁽¹⁾ | Package Type | Package Drawing | Pins | Package Qty | Eco Plan ⁽²⁾ | Lead/ Ball Finish | MSL Peak Temp ⁽³⁾ | Samples (Requires Login) |
|------------------|-----------------------|--------------|-----------------|------|-------------|-------------------------|----------------------|------------------------------|--------------------------------------|
| TPS2214ADB | ACTIVE | SSOP | DB | 24 | 60 | Green (RoHS & no Sb/Br) | CU NIPDAU | Level-1-260C-UNLIM | Request Free Samples |
| TPS2214ADBG4 | ACTIVE | SSOP | DB | 24 | 60 | Green (RoHS & no Sb/Br) | CU NIPDAU | Level-1-260C-UNLIM | Request Free Samples |
| TPS2214ADBR | ACTIVE | SSOP | DB | 24 | 2000 | Green (RoHS & no Sb/Br) | CU NIPDAU | Level-1-260C-UNLIM | Purchase Samples |
| TPS2214ADBRG4 | ACTIVE | SSOP | DB | 24 | 2000 | Green (RoHS & no Sb/Br) | CU NIPDAU | Level-1-260C-UNLIM | Purchase Samples |
| TPS2216ADAP | ACTIVE | HTSSOP | DAP | 32 | 46 | Green (RoHS & no Sb/Br) | CU NIPDAU | Level-3-260C-168 HR | Request Free Samples |
| TPS2216ADAPG4 | ACTIVE | HTSSOP | DAP | 32 | 46 | Green (RoHS & no Sb/Br) | CU NIPDAU | Level-3-260C-168 HR | Request Free Samples |
| TPS2216ADB | ACTIVE | SSOP | DB | 30 | 50 | Green (RoHS & no Sb/Br) | CU NIPDAU | Level-1-260C-UNLIM | Request Free Samples |
| TPS2216ADBG4 | ACTIVE | SSOP | DB | 30 | 50 | Green (RoHS & no Sb/Br) | CU NIPDAU | Level-1-260C-UNLIM | Request Free Samples |
| TPS2216ADBR | ACTIVE | SSOP | DB | 30 | 2000 | Green (RoHS & no Sb/Br) | CU NIPDAU | Level-1-260C-UNLIM | Purchase Samples |
| TPS2216ADBRG4 | ACTIVE | SSOP | DB | 30 | 2000 | Green (RoHS & no Sb/Br) | CU NIPDAU | Level-1-260C-UNLIM | Purchase Samples |

⁽¹⁾ The marketing status values are defined as follows:

ACTIVE: Product device recommended for new designs.

LIFEBUY: TI has announced that the device will be discontinued, and a lifetime-buy period is in effect.

NRND: Not recommended for new designs. Device is in production to support existing customers, but TI does not recommend using this part in a new design.

PREVIEW: Device has been announced but is not in production. Samples may or may not be available.

OBSELETE: TI has discontinued the production of the device.

⁽²⁾ Eco Plan - The planned eco-friendly classification: Pb-Free (RoHS), Pb-Free (RoHS Exempt), or Green (RoHS & no Sb/Br) - please check <http://www.ti.com/productcontent> for the latest availability information and additional product content details.

TBD: The Pb-Free/Green conversion plan has not been defined.

Pb-Free (RoHS): TI's terms "Lead-Free" or "Pb-Free" mean semiconductor products that are compatible with the current RoHS requirements for all 6 substances, including the requirement that lead not exceed 0.1% by weight in homogeneous materials. Where designed to be soldered at high temperatures, TI Pb-Free products are suitable for use in specified lead-free processes.

Pb-Free (RoHS Exempt): This component has a RoHS exemption for either 1) lead-based flip-chip solder bumps used between the die and package, or 2) lead-based die adhesive used between the die and leadframe. The component is otherwise considered Pb-Free (RoHS compatible) as defined above.

Green (RoHS & no Sb/Br): TI defines "Green" to mean Pb-Free (RoHS compatible), and free of Bromine (Br) and Antimony (Sb) based flame retardants (Br or Sb do not exceed 0.1% by weight in homogeneous material)

⁽³⁾ MSL, Peak Temp. -- The Moisture Sensitivity Level rating according to the JEDEC industry standard classifications, and peak solder temperature.

Important Information and Disclaimer: The information provided on this page represents TI's knowledge and belief as of the date that it is provided. TI bases its knowledge and belief on information provided by third parties, and makes no representation or warranty as to the accuracy of such information. Efforts are underway to better integrate information from third parties. TI has taken and continues to take reasonable steps to provide representative and accurate information but may not have conducted destructive testing or chemical analysis on incoming materials and chemicals. TI and TI suppliers consider certain information to be proprietary, and thus CAS numbers and other limited information may not be available for release.

In no event shall TI's liability arising out of such information exceed the total purchase price of the TI part(s) at issue in this document sold by TI to Customer on an annual basis.

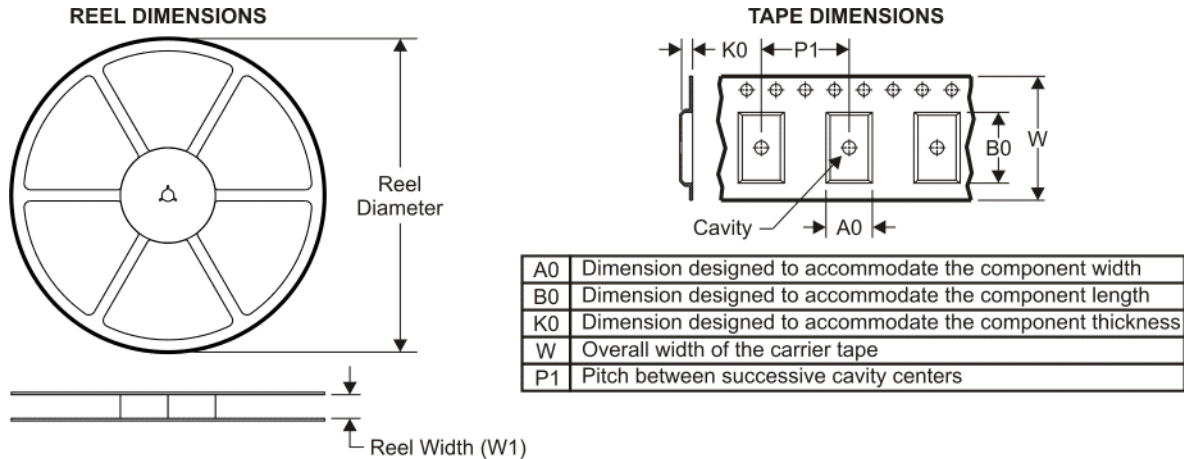
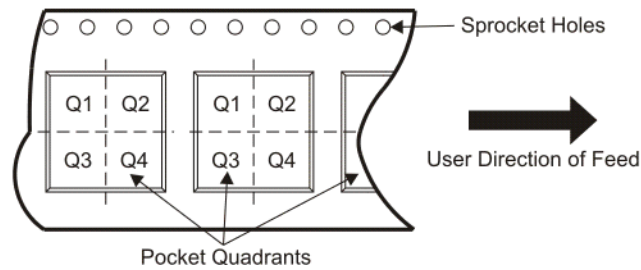
TAPE AND REEL INFORMATION

QUADRANT ASSIGNMENTS FOR PIN 1 ORIENTATION IN TAPE

*All dimensions are nominal

| Device | Package Type | Package Drawing | Pins | SPQ | Reel Diameter (mm) | Reel Width W1 (mm) | A0 (mm) | B0 (mm) | K0 (mm) | P1 (mm) | W (mm) | Pin1 Quadrant |
|-------------|--------------|-----------------|------|------|--------------------|--------------------|---------|---------|---------|---------|--------|---------------|
| TPS2214ADBR | SSOP | DB | 24 | 2000 | 330.0 | 16.4 | 8.2 | 8.8 | 2.5 | 12.0 | 16.0 | Q1 |
| TPS2216ADBR | SSOP | DB | 30 | 2000 | 330.0 | 16.4 | 8.2 | 10.5 | 2.5 | 12.0 | 16.0 | Q1 |

TAPE AND REEL BOX DIMENSIONS

*All dimensions are nominal

| Device | Package Type | Package Drawing | Pins | SPQ | Length (mm) | Width (mm) | Height (mm) |
|-------------|--------------|-----------------|------|------|-------------|------------|-------------|
| TPS2214ADBR | SSOP | DB | 24 | 2000 | 346.0 | 346.0 | 33.0 |
| TPS2216ADBR | SSOP | DB | 30 | 2000 | 346.0 | 346.0 | 33.0 |

DB (R-PDSO-G**)

PLASTIC SMALL-OUTLINE

28 PINS SHOWN



- NOTES: A. All linear dimensions are in millimeters.
 B. This drawing is subject to change without notice.
 C. Body dimensions do not include mold flash or protrusion not to exceed 0,15.
 D. Falls within JEDEC MO-150

IMPORTANT NOTICE

Texas Instruments Incorporated and its subsidiaries (TI) reserve the right to make corrections, modifications, enhancements, improvements, and other changes to its products and services at any time and to discontinue any product or service without notice. Customers should obtain the latest relevant information before placing orders and should verify that such information is current and complete. All products are sold subject to TI's terms and conditions of sale supplied at the time of order acknowledgment.

TI warrants performance of its hardware products to the specifications applicable at the time of sale in accordance with TI's standard warranty. Testing and other quality control techniques are used to the extent TI deems necessary to support this warranty. Except where mandated by government requirements, testing of all parameters of each product is not necessarily performed.

TI assumes no liability for applications assistance or customer product design. Customers are responsible for their products and applications using TI components. To minimize the risks associated with customer products and applications, customers should provide adequate design and operating safeguards.

TI does not warrant or represent that any license, either express or implied, is granted under any TI patent right, copyright, mask work right, or other TI intellectual property right relating to any combination, machine, or process in which TI products or services are used. Information published by TI regarding third-party products or services does not constitute a license from TI to use such products or services or a warranty or endorsement thereof. Use of such information may require a license from a third party under the patents or other intellectual property of the third party, or a license from TI under the patents or other intellectual property of TI.

Reproduction of TI information in TI data books or data sheets is permissible only if reproduction is without alteration and is accompanied by all associated warranties, conditions, limitations, and notices. Reproduction of this information with alteration is an unfair and deceptive business practice. TI is not responsible or liable for such altered documentation. Information of third parties may be subject to additional restrictions.

Resale of TI products or services with statements different from or beyond the parameters stated by TI for that product or service voids all express and any implied warranties for the associated TI product or service and is an unfair and deceptive business practice. TI is not responsible or liable for any such statements.

TI products are not authorized for use in safety-critical applications (such as life support) where a failure of the TI product would reasonably be expected to cause severe personal injury or death, unless officers of the parties have executed an agreement specifically governing such use. Buyers represent that they have all necessary expertise in the safety and regulatory ramifications of their applications, and acknowledge and agree that they are solely responsible for all legal, regulatory and safety-related requirements concerning their products and any use of TI products in such safety-critical applications, notwithstanding any applications-related information or support that may be provided by TI. Further, Buyers must fully indemnify TI and its representatives against any damages arising out of the use of TI products in such safety-critical applications.

TI products are neither designed nor intended for use in military/aerospace applications or environments unless the TI products are specifically designated by TI as military-grade or "enhanced plastic." Only products designated by TI as military-grade meet military specifications. Buyers acknowledge and agree that any such use of TI products which TI has not designated as military-grade is solely at the Buyer's risk, and that they are solely responsible for compliance with all legal and regulatory requirements in connection with such use.

TI products are neither designed nor intended for use in automotive applications or environments unless the specific TI products are designated by TI as compliant with ISO/TS 16949 requirements. Buyers acknowledge and agree that, if they use any non-designated products in automotive applications, TI will not be responsible for any failure to meet such requirements.

Following are URLs where you can obtain information on other Texas Instruments products and application solutions:

| Products | | Applications | |
|-----------------------------|--|----------------------------|--|
| Amplifiers | amplifier.ti.com | Audio | www.ti.com/audio |
| Data Converters | dataconverter.ti.com | Automotive | www.ti.com/automotive |
| DLP® Products | www.dlp.com | Communications and Telecom | www.ti.com/communications |
| DSP | dsp.ti.com | Computers and Peripherals | www.ti.com/computers |
| Clocks and Timers | www.ti.com/clocks | Consumer Electronics | www.ti.com/consumer-apps |
| Interface | interface.ti.com | Energy | www.ti.com/energy |
| Logic | logic.ti.com | Industrial | www.ti.com/industrial |
| Power Mgmt | power.ti.com | Medical | www.ti.com/medical |
| Microcontrollers | microcontroller.ti.com | Security | www.ti.com/security |
| RFID | www.ti-rfid.com | Space, Avionics & Defense | www.ti.com/space-avionics-defense |
| RF/IF and ZigBee® Solutions | www.ti.com/lprf | Video and Imaging | www.ti.com/video |
| | | Wireless | www.ti.com/wireless-apps |