

# Poly-carbonmonofluoride Lithium Coin Batteries: Individual Specifications

## BR1225

### ■ Dimensions(mm)

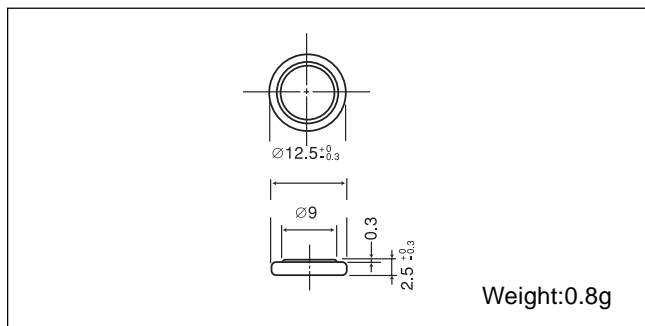

### ■ Specification

Nominal voltage (V)	3
Nominal capacity (mAh)	48
Continuous standard load (mA)	0.03
Operating temperature (C)	-30 ~ +80

### ■ Temperature Characteristics

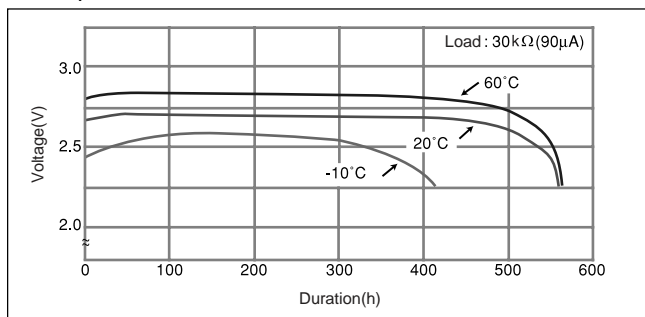

### ■ Operating voltage vs. load resistance (voltage at 50% discharge depth)

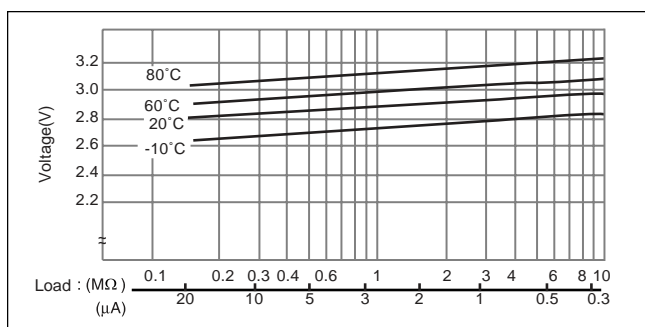

### ■ Capacity vs. load resistance

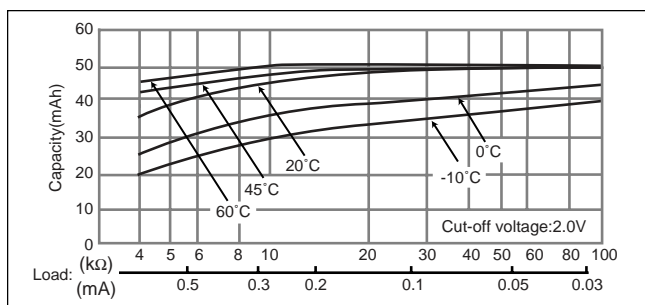

## BR1616

### ■ Dimensions(mm)

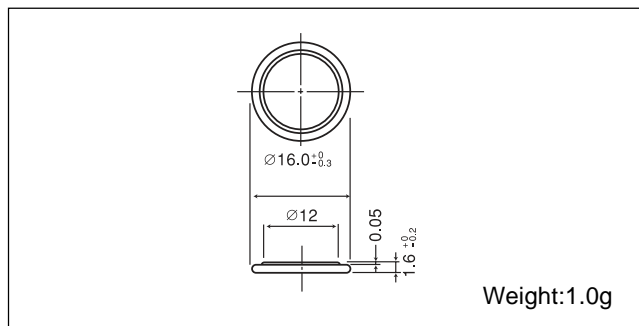

### ■ Specification

Nominal voltage (V)	3
Nominal capacity (mAh)	48
Continuous standard load (mA)	0.03
Operating temperature (C)	-30 ~ +80

### ■ Temperature Characteristics

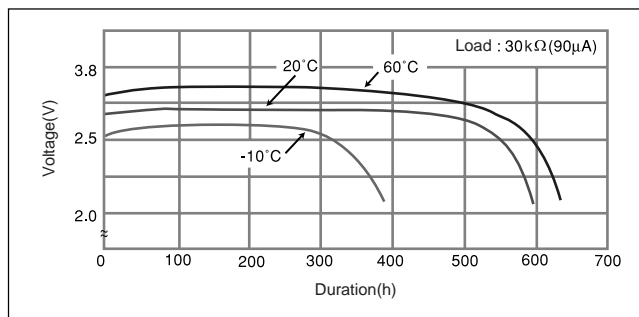

### ■ Operating voltage vs. load resistance (voltage at 50% discharge depth)

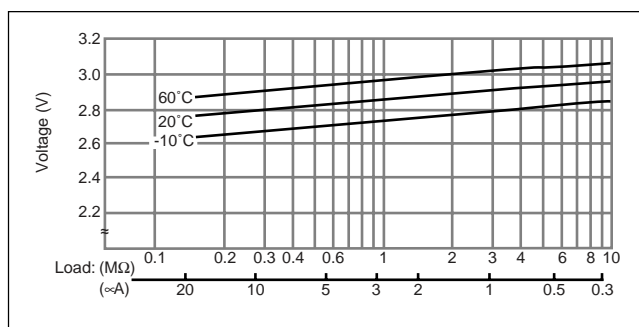

### ■ Capacity vs. load resistance

