

Encoder | Encoders



427

Ausführung

- Miniatur -2-Bit-Encoder
- 15, 16 oder 30 Schaltstellungen
- Horizontale oder vertikale Betätigung
- Ohne oder mit Tastschalter
- Verschiedene Gehäusevarianten
- Verschiedene Drehmomente
- Optional: verschiedene Achsvarianten

Anschlüsse

SMD- oder THT- Ausführung

Abmessungen

Vertikal: 11,5 x 13,7 x 5,3 mm
Horizontal: 11,5 x 5,3 x 13,7 mm

427

Construction

- Miniatur 2-bit encoder
- 15, 16 or 30 positions
- Operated horizontally or vertically
- Without or with tactile push switch
- Various housing designs
- Various torques
- Optional: multiple shaft designs

Pining

SMD or THT design

Dimensions

Vertical: 11.5 x 13.7 x 5.3 mm
Horizontal: 11.5 x 5.3 x 13.7 mm

Ausführung Construction	Anschlußmaße Abmessungen	See drawing See drawing	Pining Outline Dimensions
Isolierwerkstoffe Insulation Material	Gehäuse Kontaktträger	Thermoplastic-UL-94-Vo Thermoplastic-UL-94-Vo	Housing Contact Body
Elektrische Daten Electrical Data	Übergangswiderstand (Neuwert) Isolierwiderstand Kapazität Durchschlagfestigkeit	< 100 mOhm > 100 MOhm < 2 pF See drawing	Contact Resistance (new conditions) Insulation Resistance Capacity Resistance of phase
Mechanische Daten Mechanical Data	Betriebstemperatur Lagertemperatur Handlötung Wellenlötung Reflow (nur SMD)	-40 °C to +85°C -55 °C to +90°C 3 s +300°C 4 s +260°C 5 s +260°C acc. to IPC/JEDEC J-STD -020D Tab. 4-2 (max. peak temperature +260°)	Operation Temp. Storage Temp. Manual soldering Dip soldering (wave) Reflow soldering (SMD only)
Dichtheit Sealing	Zwischen Achse und Gehäuse Mit O-Ring Ohne O-Ring	IP 67 IP 50	Between shaft and housing With O-ring Without O-ring
Anzugsdrehmoment (Gehäuse) tightening torque (housing)	Gehäuse 5 & 9 Gehäuse D & F	60 Ncm 100 Ncm	housing 5 & 9 housing D & F

Impulsschalter | Encoder

Kontaktwerkstoffe Contact Material	Festkontakte Schaltkontakte Lötanschlüsse	CuSn plating: see drawings CuBe gal. Ni 1 Au 1 Sn	Fixed Contacts Sliding Contacts Pins
Elektrische Daten Electrical Data	Schaltspannung Schaltstrom Ag Schaltstrom Au Prellung und Signaleinbruch Impulszeit	Max. 5 VDC Min. 1 mA, max. 10 mA Min. 1µmA, max. 10 mA 2 ms max. at 60 rpm 6 ms min. at 60 rpm	Switching Voltage Switching Current Ag Switching Current Au Bounce Difference of phase
Mechanische Daten Mechanical Data	Gesamter Drehwinkel Anzahl der Impulse Lebensdauer (Umdrehungen) Drehmoment (Neuwert)	360° endless See drawing > 100.000 See drawing	Overall rotation angle Pulse quantity Life expectancy (rotations) Rotational torque (new condition)

Endschalter | Tactile Push Button Switch

Isolierwerkstoffe Insulation Material	Betätiger	Aluminium	Actuator
Kontaktwerkstoffe Contact Material	Festkontakte Schaltkontakte Lötanschlüsse	CuZn gal Ni 1 Au flash Steel gal. Ni 1 Au flash Sn	Fixed Contacts Sliding Contacts Pins
Elektrische Daten Electrical Data	Schaltspannung Schaltstrom Kontaktprellen	Max. 16 VDC Min. 1 mA, max, 300 mA < 2 ms	Switching Voltage Switching Current Bounce
Mechanische Daten Mechanical Data	Tasthub Betätigungskraft Lebensdauer (Hübe)	0,5 mm See drawing > 100.000	Stroke Operating Force Life Expectancy (travels)

Impulsbild (Standard) Impulse diagram (standard)

Impulsbild in CW-Richtung bei 30 Rastpositionen
impulse diagram in CW direction with 30 detent positions

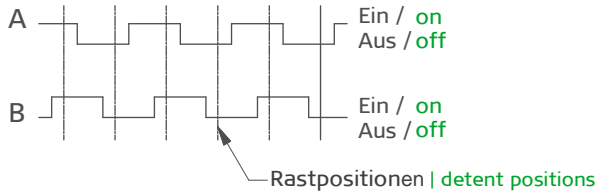

Impulsbild in CW-Richtung bei 15 Rastpositionen
impulse diagram in CW direction with 15 detent positions

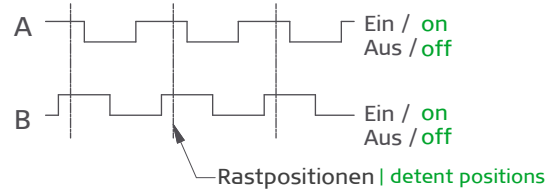

Impulsbild in CCW-Richtung bei 30 Rastpositionen
impulse diagram in CCW direction with 30 detent positions

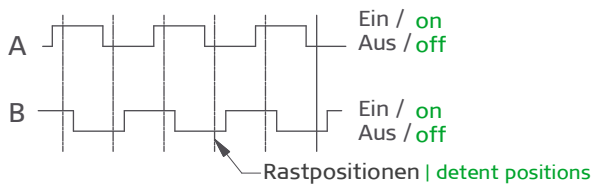

Schaltbild circuit diagram

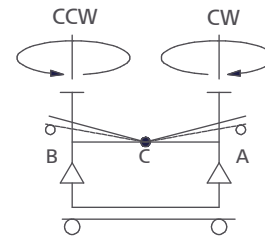

Bei 16 Rastpositionen ist das Impulsbild Invertiert.
AT 16 detent positions the impulse diagram is inverted.

---> Impulsbild Invertiert auf Anfrage
---> impulse diagram on application

Empfohlene Reflow Temperaturkurve recommended reflow temperature profile

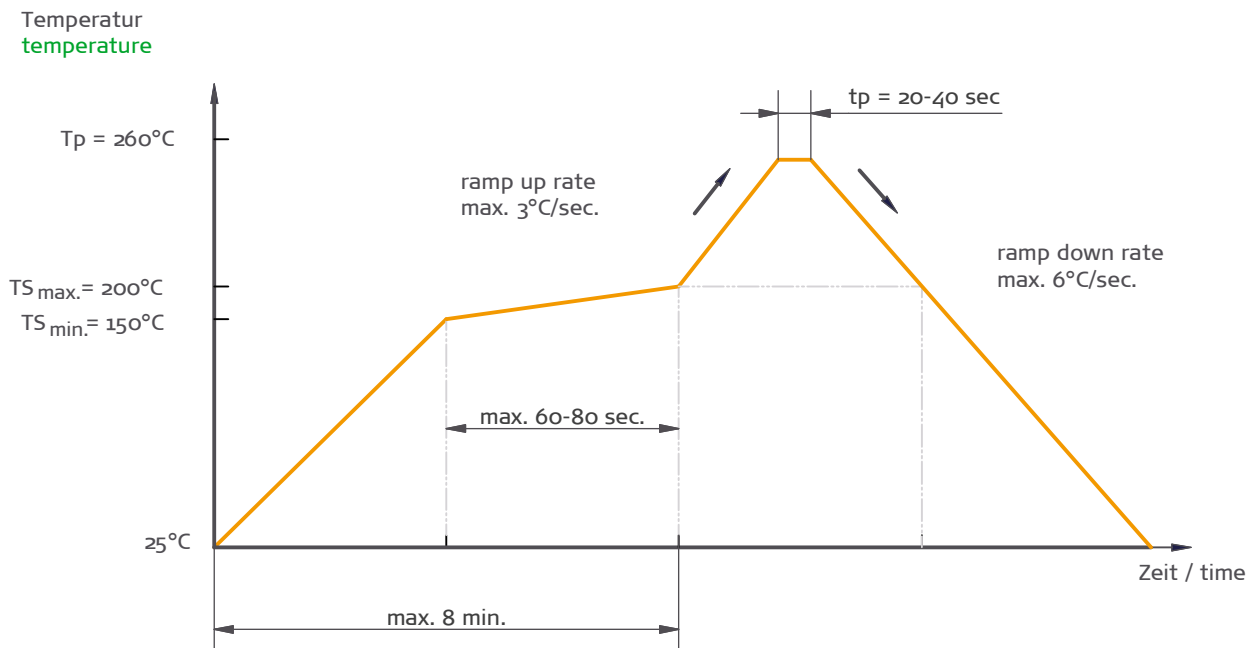



Anzahl der Rastpositionen number of detent positions

Codierscheibe vergoldet
code disc gold (gal. Au1)

Codierscheibe versilbert
code disc silver (gal. Ag3)

0	A	30 Positionen Standard (A vor B) 30 positions (standard)
1	B	16 Positionen (B vor A) 16 positions
6	G	15 Positionen (A vor B) 15 positions



Schalterausführung Switch version

--> siehe folgende Seite
--> have a look at following page

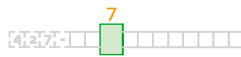

Taktile Tastschalter Tactile push button switch

- 0 Ohne Tastschalter
without tactile push button switch
- 1 Mit Tastschalter $F = 6N \pm 2N$ (Standard)
with tactile push button switch $F = 6N \pm 2N$ (standard)
- 2 Mit Tastschalter $F = 3N$
with tactile push button switch $F = 3N$

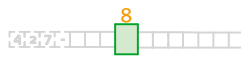

Rastung detent

- 0 Ohne Rastung
without detent
- 1 Rastung mit 1,5 Ncm Drehmoment (Standard)
detent 1,5 Ncm torque (standard)
- 2 Rastung mit 2,5 Ncm Drehmoment
(Lebensdauer > 10.000 Umdrehungen)
detent 2,5 Ncm torque
(life expectancy > 10.000 rotations)
- 3 Rastung mit 0,5 Ncm Drehmoment
detent 0,5 Ncm torque

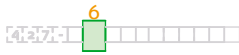

Schalterausführung | switch version

- 1 horizontale Ausführung **ohne** Tastschalter
horizontal version **without** tactile push button switch

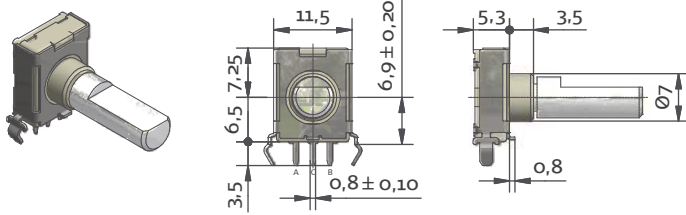

Leiterplattenlochbild Bauteilseite
drilling matrix component side

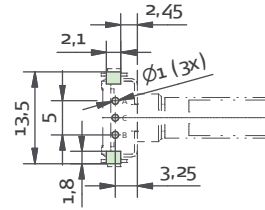

- 1 horizontale Ausführung **mit** Tastschalter
horizontal version **with** tactile push button switch

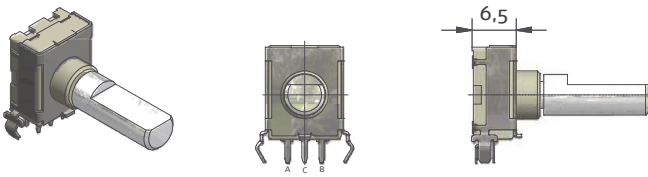

Leiterplattenlochbild Bauteilseite
drilling matrix component side

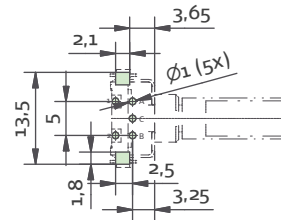

- 2 vertikale Ausführung **ohne** Tastschalter
vertical version **without** tactile push button switch

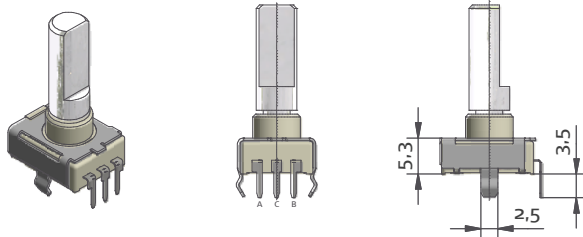

Leiterplattenlochbild Bauteilseite
drilling matrix component side

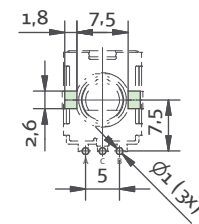

- 2 vertikale Ausführung **mit** Tastschalter
vertical version **with** tactile push button switch

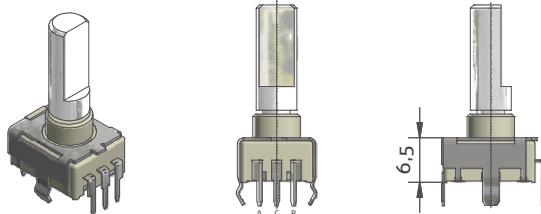

Leiterplattenlochbild Bauteilseite
drilling matrix component side

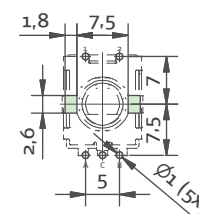

- 5 vertikale Ausführung **ohne** Tastschalter SMD
vertical version **without** tactile push button switch SMD

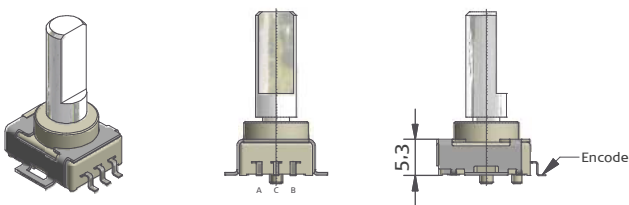

Löt-Pad-Anordnung
SMD soldering pad

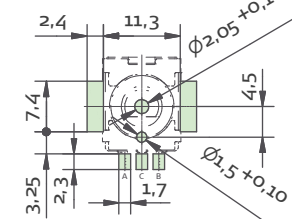

- 5 vertikale Ausführung **mit** Tastschalter SMD
vertical version **with** tactile push button switch SMD

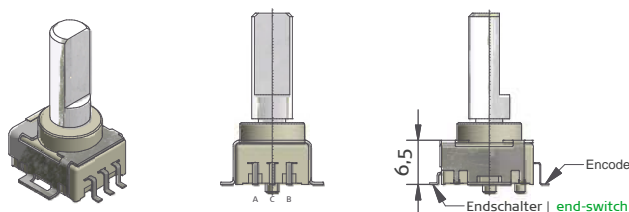

Löt-Pad-Anordnung
SMD soldering pad

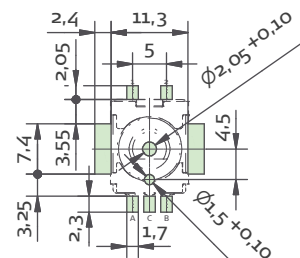

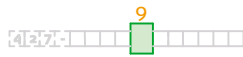

Gehäuseausführung (Kunststoff)
housing version (plastic)

0 Gehäuse Ø7 x 3,5
housing Ø7 x 3,5

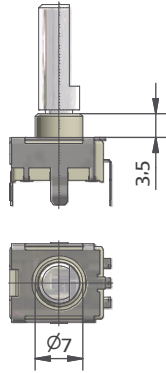

4 Gehäuse Ø9,5 x 2,6
housing Ø9,5 x 2,6

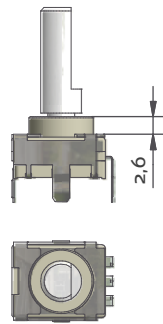

5 Gehäuse M7 x 7,3 mit Bund
housing M7 x 7,3 with collar

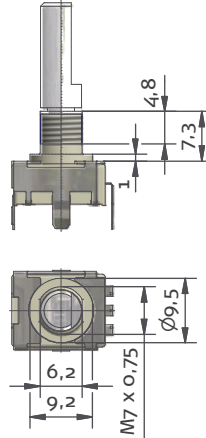

9 Gehäuse M6 X 4,5
housing M6 x 4,5

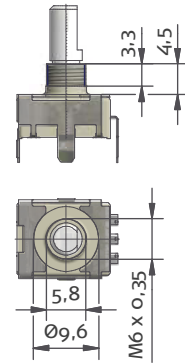

Gehäuseausführung (Zinkdruckguß)
housing version (zinc diecasting)

D Gehäuse M7 x 7,3 mit Bund
housing M7 x 7,3 with collar

G Gehäuse M6 x 4,5
housing M6 x 4,5

Gehäuse 9 optional auch im MIM-Verfahren lieferbar (Sinterstahl 1.4404)
housing 9 optional also in MIM-technique available (sintered steel 1.4404)



Achsausführung
shaft version

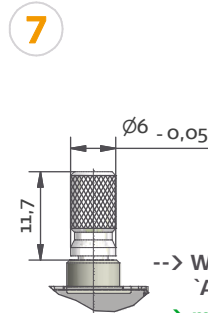
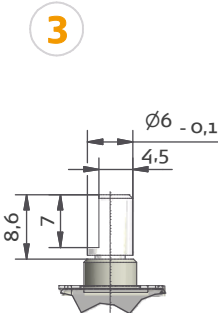
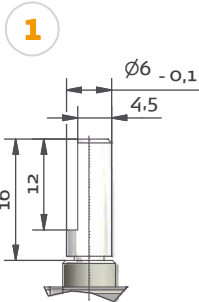

0 ohne Achse
without shaft

1 Standard
standard

3 Achse 8mm lang
shaft 8mm long

7 Kreuzrändel
cross knurl-shaft

Sonderachsen auf Anfrage möglich
other shaft versions on request

--> Werkstoffauswahl der Achse siehe Bereich: 'Achs-Leitfähigkeit / Durchschlagsfestigkeit'
--> material of the shaft have a look at the area: 'shaft-conductivity / resistance to voltage'

Achtung: Über diese Achsen läßt sich keine M6 Mutter montieren.
Attention: You can't mount the switch with a M6 nut - won't fit over the shaft diameter.



**Achs-Leitfähigkeit/
Durchschlagsfestigkeit**
shaft-conductivity/
resistance to voltage

00 ohne Achse
without shaft

AL Aluminium, elektr. leitend (Standard)
aluminium, conductive (standard)

AE Aluminium, elektr. isoliert (≥ 2kV)
aluminium, electric insulate (≥ 2kV)



Dichtung
sealed

0 Ohne O-Ring
without O-ring

1 Mit O-Ring (Standard)
with O-ring (standard)

2 Ohne O-Ring mit Dichtscheibe
without O-ring with gasket

3 Mit O-Ring mit Dichtscheibe
with O-ring with gasket

Dichtscheibe | gasket

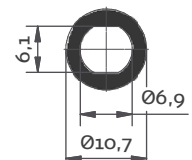

nur für Gewinde M7
only for thread M7

Werkstoffe Materials	Blistergurt	PS plastic	Embossed tape
	Abdeckband	PE paper	Reel
Abdeckband Top Cover Tape	Zugmoment	min. 10 Nm	Embossed tape pull strength
	Abzugswinkel	165°C - 180°C	Peel of angle
	Abzugsgeschwindigkeit	300 mm / min.	Peel speed
	Abzugskraft	0.1 - 0.7 Nm	Peel force

15 **Verpackung | packaging**

1 Palette (THT) | **palette (THT)**

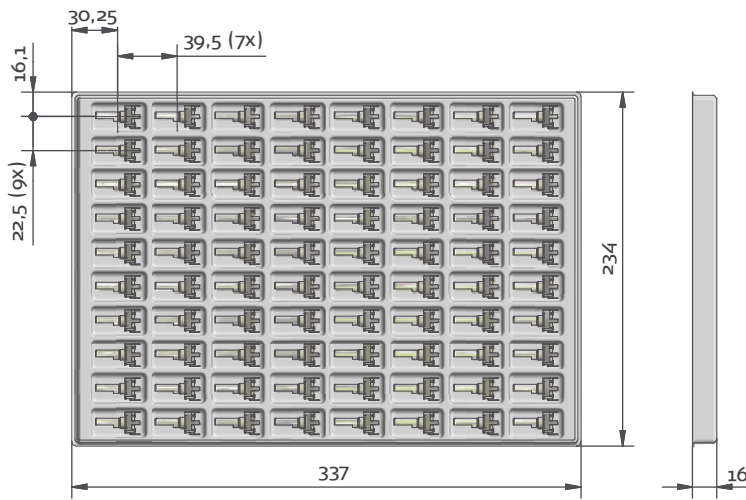

Daten der Palette
properties of the palette

max. Stückzahl number of pieces	80	Werkstoffe Materials	Palette palette PS Deckel cover PVC
------------------------------------	----	------------------------	--

2 Gurt (SMD) | **embossed tape (SMD)**

Blistergurtabmessungen
embossed tape dimensions

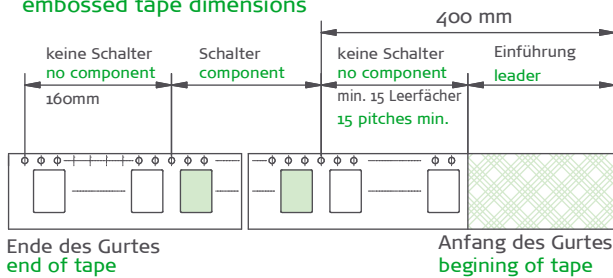

Ende des Gurtes
end of tape

Anfang des Gurtes
beginning of tape

Spulenabmessungen
reel dimensions

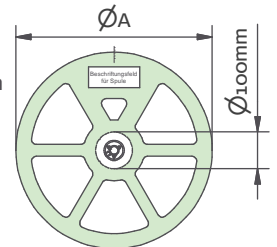

max. Stückzahl number of pieces	Takt tact	Maß "A" dimension "A"	Ausführung version
300 Stück	20mm	330mm	Gehäuse 4
300 Stück	24mm	380mm	Gehäuse 5

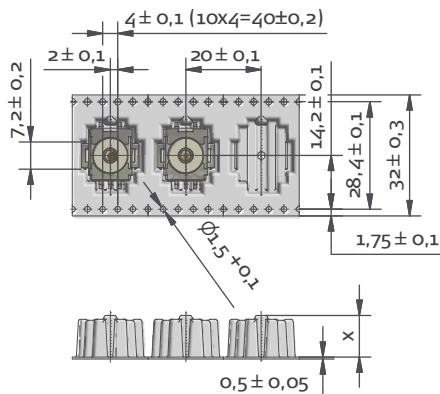

Abzugsrichtung | peel direction

Abdeckband
top cover tape

Blistergurt
carrier tape

Vorschubrichtung
direction of feed

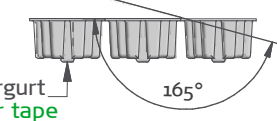

Zubehör utilities

Mutter | nut
M7 x 0,75

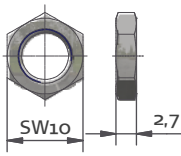

(nur für Gehäuseausführung 5 und D)
(only for housing version 5 and D)

Scheibe | washer
DIN 125

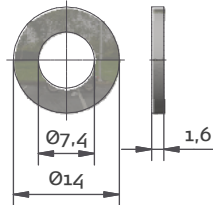

Mutter | nut
M6 x 0,35

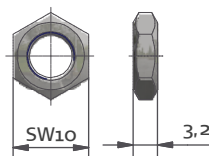

(nur für Gehäuseausführung 9 und F)
(only for housing version 9 and F)



0	3	kein Zubehör (Standard) without utilities
1	4	mit Mutter with nut
2	5	mit Mutter und Scheibe with nut and washer

Achse montiert
shaft assembled
 Achse lose beigestellt
shaft delivered separately

Für Gehäuse D + F nur "Achse montiert" wählbar
for housing D + F only "shaft assembled" selectable

Bestell-Schlüssel ordering code



Anzahl der Rastpositionen
number of detent positions

Schalerausführung
switch version

Tastschalter
tactile push button switch

Rastung
detent

Gehäuseausführung
housing version

Achsausführung
shaft version

Achs-Leitfähigkeit/Durchschlagsfestigkeit
shaft-conductivity/resistance to voltage

Dichtung
sealed

Zubehör
utilities

Verpackung
packaging

Dieses Schema zeigt, wie ein Schalter 427 mit einem Mikrocontroller angeschlossen wird.

In order to minimize effect of spikes or bounds, this schema shows an example with a switch 427 connected to a micro-controller.

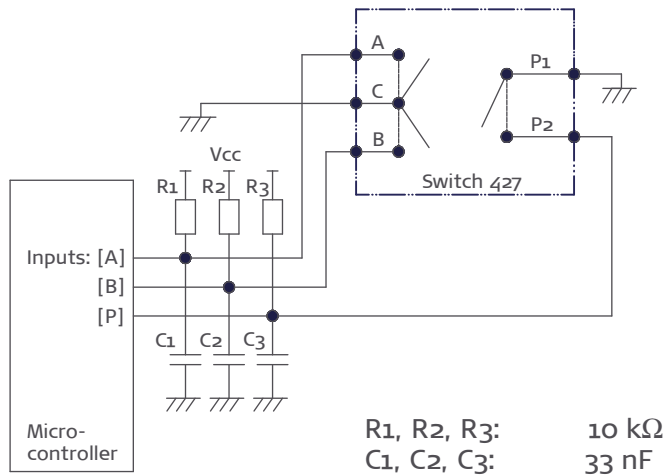

Anwendung

Dieser Algorithmus ist ein umfassendes Software Beispiel im Mikrocontroller für die Abfragung der Antriebe, die durch diesen Schalter gegeben werden.

Application notes

This algorithm is a software example to include into a micro-controller for the detection of impulses given by this switch.

CCW ← Direction → CW

Steps	N-3	N-2	N-1	N	N+1	N+2	N+3	N+4
[AB]	[10]	[11]	[01]	[00]	[10]	[11]	[01]	[00]
A xor B	1	0	1	0	1	0	1	0
[AB] _N xor [AB] _{N-1}	[10]	[01]	[10]	[01]	[10]	[01]	[10]	[01]
[AB] _{N+1} xor [AB] _N	[01]	[10]	[01]	[10]	[01]	[10]	[01]	[10]

Inputzustände:

Wir betrachten hier jeden Step wie
 wenn eine Position [AB] = [00] or [AB] = [11]
 wenn ein Übergang [AB] = [10] or [AB] = [01]

Input states:

We consider here each step as
 a position when [AB] = [00] or [AB] = [11]
 a transition when [AB] = [10] or [AB] = [01]

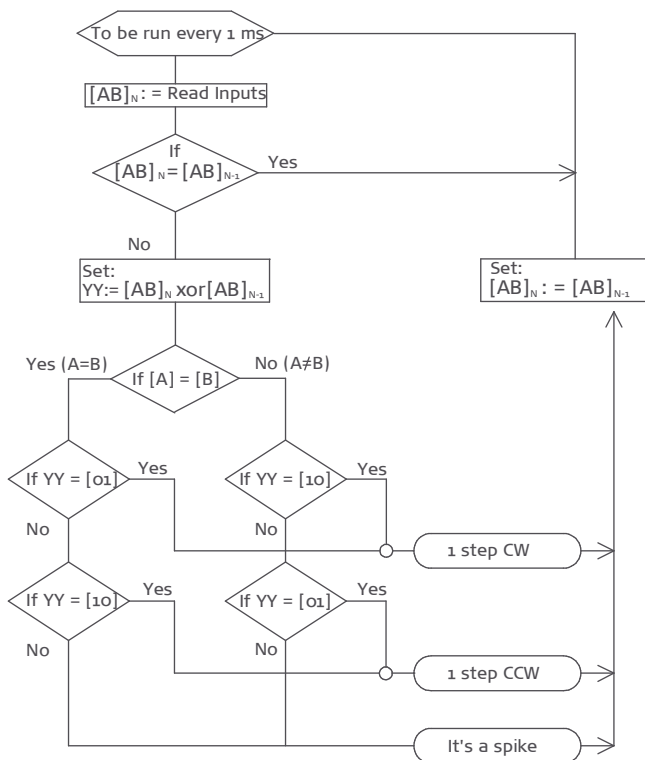

Algorithmus zum Erhalten des Stepzählimpulses und -richtung
 Algorithm to get steps count and direction:

Wenn ein Schalterpin an eine Unterbrechung Input des Mikrocontrollers angeschlossen wird und die Unterbrechung an fallender und steigender Flanke konfiguriert werden kann, sollte folgender Algorithmus einfacher einzuführen sein.

If one of the switch pin is connected to an interrupt input of the micro-controller, and the interruption can be configured at both falling and rising edge, the following algorithm should be easier to implement.

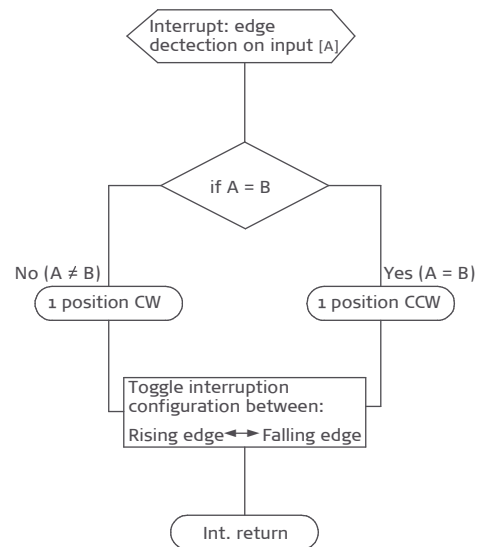

Typische Relaxion des Drehmomentes nach dem Reflow-Löten typical relaxation of the torque after reflow soldering

Bestellschlüssel ordering code	Anzahl Rastpositionen number of detents	Nominaldrehmoment nominal torque	Drehmoment torque	
			vor dem Löten before soldering	nach dem Löten after soldering
427-1XX3XXXXXXX	16	0,5 Ncm	0,75 Ncm	0,5 Ncm
427-0XX3XXXXXXX	30	0,5 Ncm	0,9 Ncm	0,55 Ncm
427-1XX1XXXXXXX	16	1,5 Ncm	1,65 Ncm	1,2 Ncm
427-0XX1XXXXXXX	30	1,5 Ncm	1,9 Ncm	1,25 Ncm
427-1XX2XXXXXXX	16	2,5 Ncm	2,85 Ncm*	
427-0XX2XXXXXXX	30	2,5 Ncm	3,35 Ncm*	

* bezogen auf eine THT-Ausführung des Schalters (Wellenlöten) | * based on a THT-version of the switch (wave soldering)

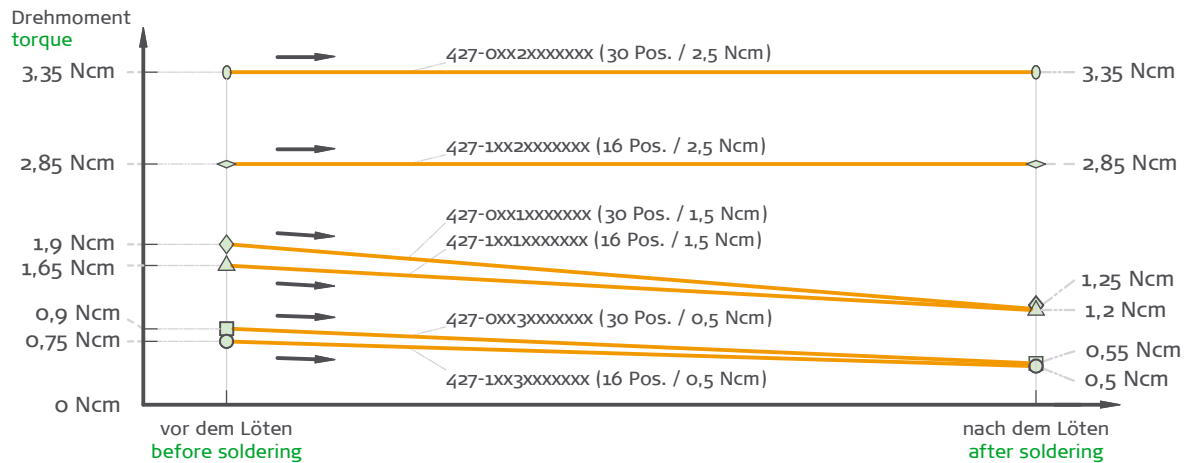

Nachlassen des Drehmomentes über die Lebensdauer (100k Umdrehungen) typical decrease of the torque during life-time (100k turns)

Bestellschlüssel ordering code	Anzahl Rastpositionen number of detents	Nominaldrehmoment nominal torque	Drehmoment torque		
			0 Umdrehungen 0 turns	30k Umdrehungen 30k turns	100k Umdrehungen 100k turns
427-1XX3XXXXXXX	16	0,5 Ncm	0,5 Ncm	-	0,42 Ncm
427-0XX3XXXXXXX	30	0,5 Ncm	0,55 Ncm	-	0,45 Ncm
427-1XX1XXXXXXX	16	1,5 Ncm	1,2 Ncm	-	1,2 Ncm
427-0XX1XXXXXXX	30	1,5 Ncm	1,25 Ncm	-	1,1 Ncm
427-1XX2XXXXXXX	16	2,5 Ncm	2,85 Ncm*	1,6 Ncm*	-
427-0XX2XXXXXXX	30	2,5 Ncm	3,35 Ncm*	1,4 Ncm*	-

* bezogen auf eine THT-Ausführung des Schalters (Wellenlöten) | * based on a THT-version of the switch (wave soldering)

