

# **QT-Brightek Mid Power Series**

## **2835 PLCC 2 IR LED**

**Part No.: QBHP686-IR4D**

**IR4: 740nm  
D: 50mA**

---

**Table of Contents:**

Introduction .....	3
Electrical / Optical Characteristic (Ta=25 °C) .....	4
Absolute Maximum Rating .....	4
Characteristic Curves.....	5
Solder Profile & Footprint.....	6
Packing .....	7
Labeling .....	8
Ordering Information .....	8
Revision History .....	9
Disclaimer .....	9

Product: QBHP686-IR4D	Date: June 23, 2020	Page 2 of 9
	Version# 1.0	

## Introduction

### Feature:

- Water clear lens
- Package in tape and reel
- AlGaAs technology
- Peak wavelength  $\lambda_p=740\text{nm}$
- Viewing Angle = 120 deg typ.

### Description:

This low profile 2835 IR LED has the height of 0.8mm. With the advantage of the fast response time and the high radiant intensity, the LED is ideal for infrared remote controls and data Transmission systems.

### Application:

- Infrared Sensor
- Optoelectronic Switch
- Smoke detector
- Drive sensor

### Certification & Compliance:

- TS16949
- ISO9001
- RoHS Compliant



### Dimension:

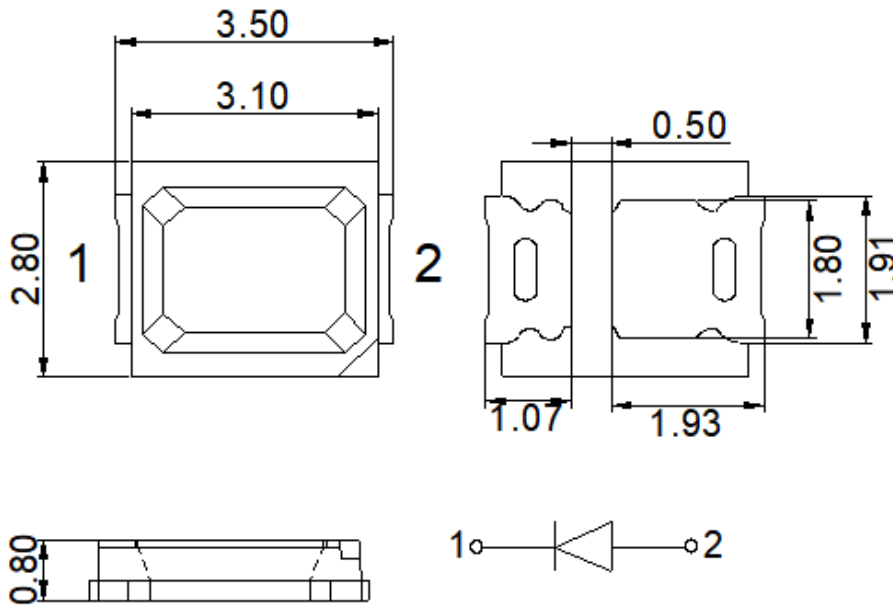

Units: mm / tolerance = +/-0.2mm

Product: QBHP686-IR4D	Date: June 23, 2020	Page 3 of 9
	Version# 1.0	

**Electrical / Optical Characteristic (Ta=25 °C)**

Product	Color	I <sub>F</sub> (mA)	V <sub>F</sub> (V)		λ <sub>P</sub> (nm)			I <sub>e</sub> (mW/sr)		
			Typ.	Max.	Min.	Typ.	Max.	Min.	Typ.	Max.
QBLP686-IR4D	Infrared	50	1.8	2.4	730	740	750	5.6	6.75	-

**Absolute Maximum Rating**

Material	P <sub>d</sub> (mW)	I <sub>F</sub> (mA)	I <sub>FP</sub> (mA)*	V <sub>R</sub> (V)	T <sub>OP</sub> (°C)	T <sub>ST</sub> (°C)	T <sub>SO L</sub> (°C)**
AlGaAs	240	100	150	5	-40 ~ +80	-40 ~ +85	260

\*Duty cycle=1%, Pulse width 100us

\*\*IR Reflow for no more than 10 sec @ 260 °C

**Forward Voltage V<sub>F</sub> @ I<sub>F</sub>=50mA**

Bin	Min.	Max.	Unit
<input type="checkbox"/>	1.4	2.4	V

**Peak Wavelength λ<sub>P</sub> @ I<sub>F</sub>=50mA**

Bin	Min.	Max.	Unit
<input type="checkbox"/>	730	750	nm

## Characteristic Curves

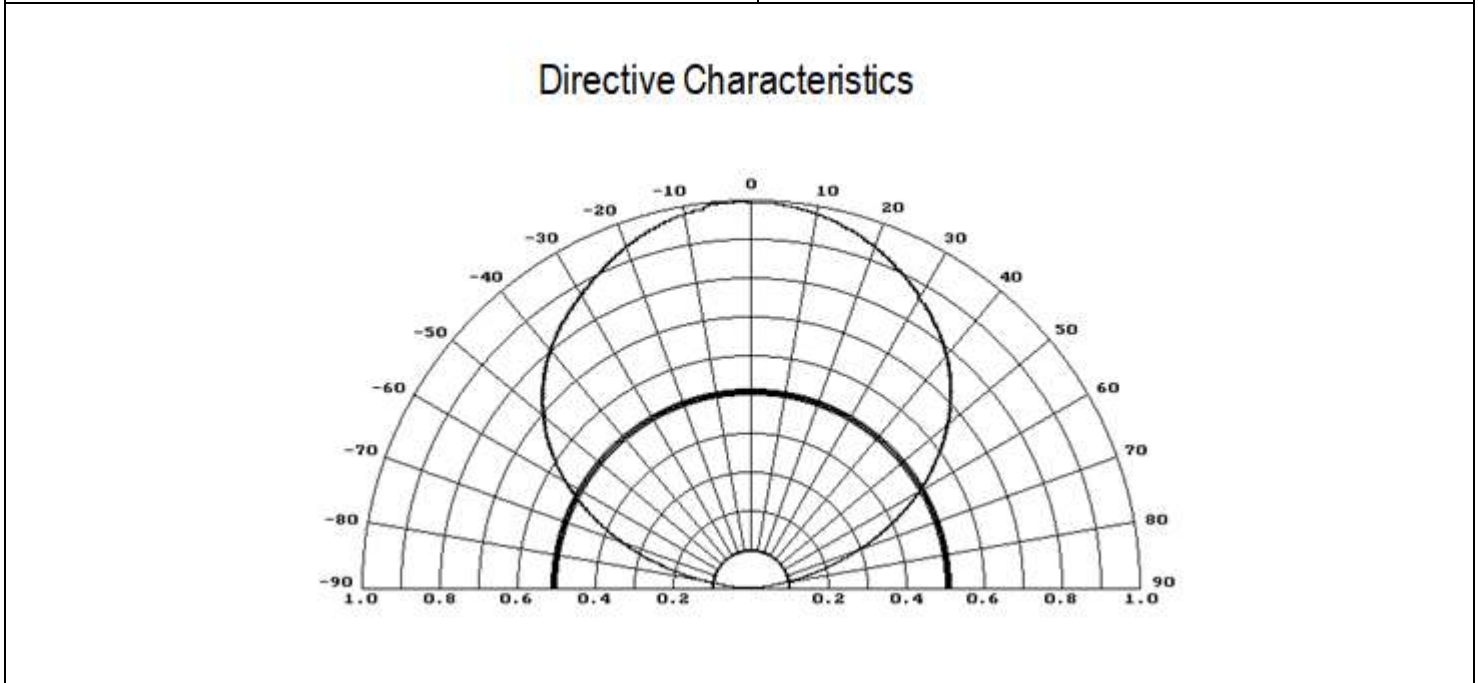
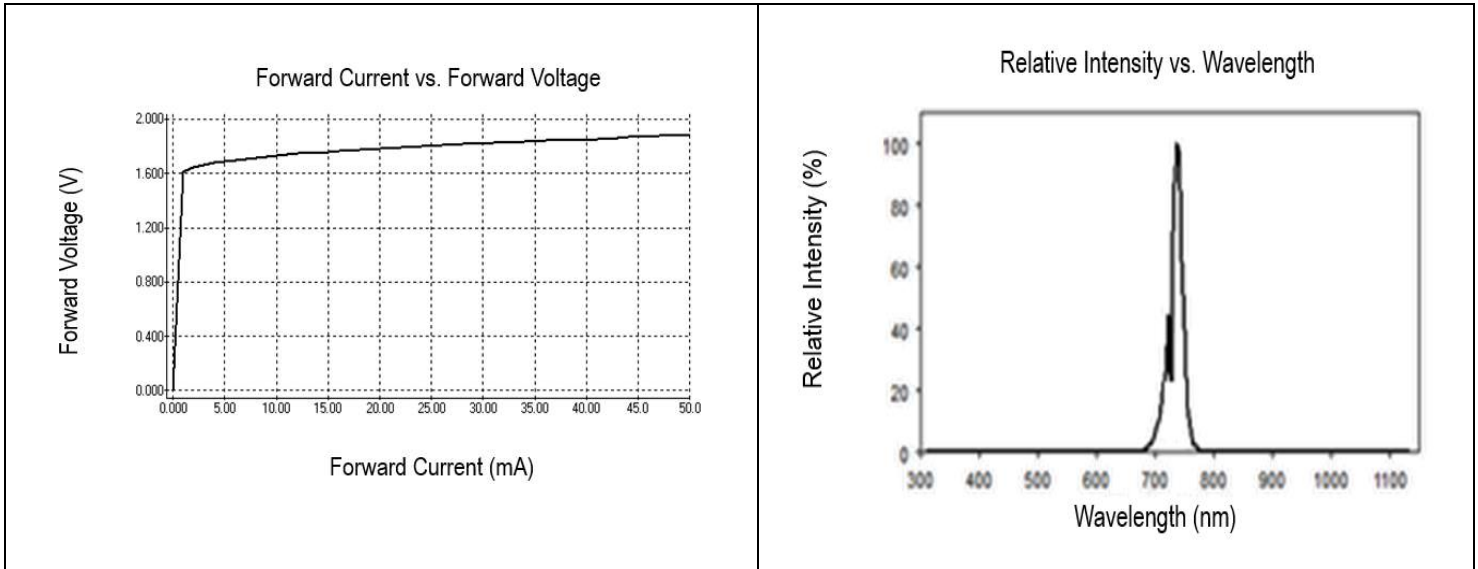

## Solder Profile & Footprint

-The recommended reflow soldering profile is as follows (temperatures indicated are as measured on the surface of the LED resin):

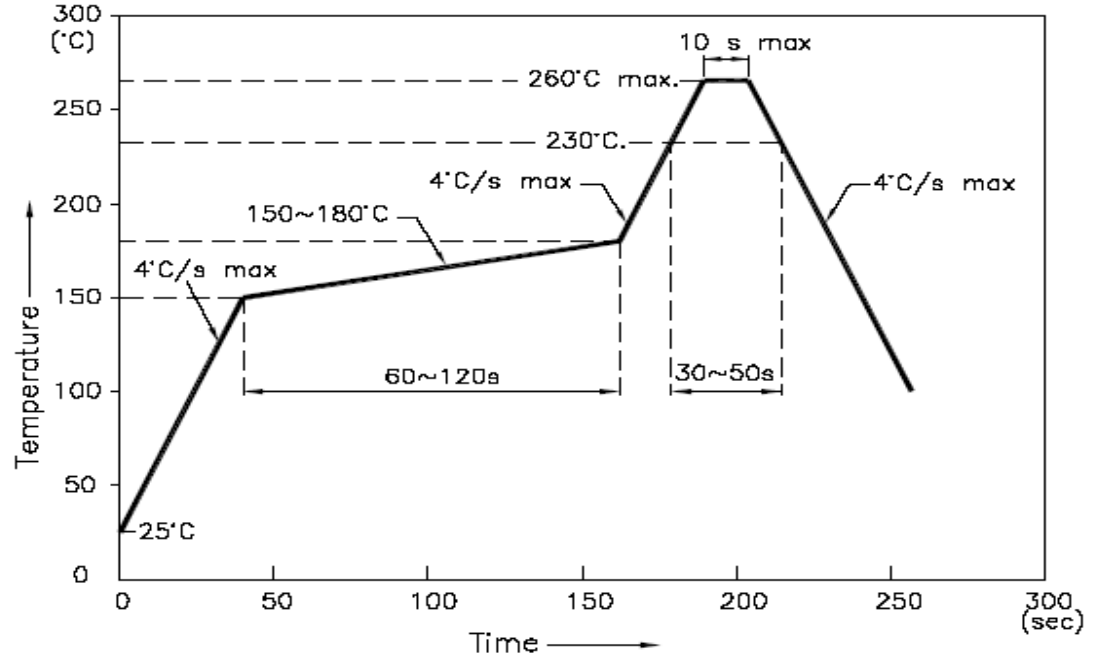

### Recommended Pad Layout

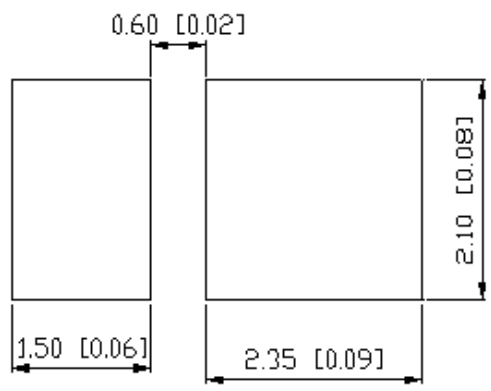

Units: mm

Tolerance: ± 0.2mm

Product: QBHP686-IR4D	Date: June 23, 2020	Page 6 of 9
	Version# 1.0	

## Packing

### Reel Dimension:

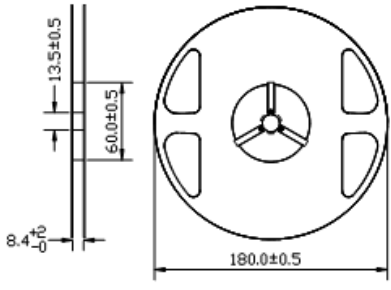

Unit: mm

### Tape Dimension:

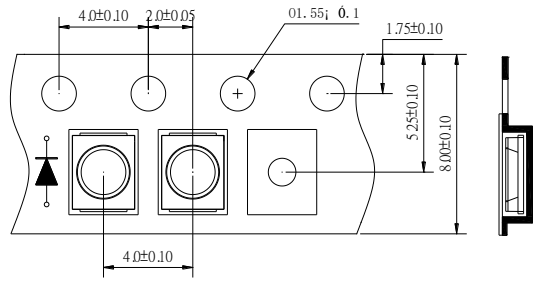

Unit: mm

### Arrangement of Tape:

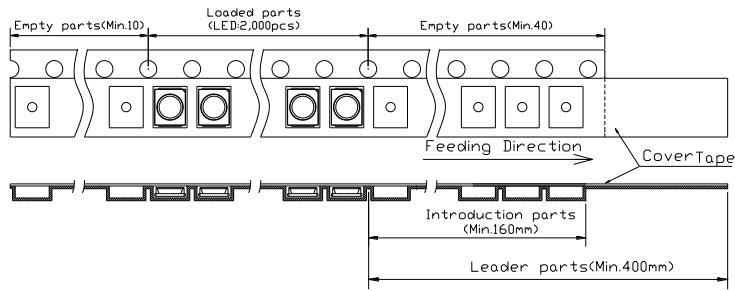

### Packaging Specification:

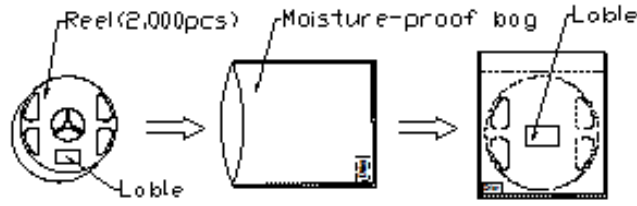

## Labeling



Part No: \_\_\_\_\_  
Customer P/N: \_\_\_\_\_  
Item: \_\_\_\_\_  
Q'ty: \_\_\_\_\_  
Vf: \_\_\_\_\_  
Iv: \_\_\_\_\_  
WI: \_\_\_\_\_  
Date: \_\_\_\_\_

**Made in China**

## Ordering Information

Part #	Orderable Part #	Spec Range	Quantity per reel
QBHP686-IR4D	QBHP686-IR4D	Ie=6.75mW/sr typ. @ If=50mA / λP=740nm typ.	2,000 units



**Revision History**

Description:	Revision #	Revision Date
New Release of QBHP686-IR4D	V1.0	06/23/2020

**Disclaimer**

QT-BRIGHTEK reserves the right to make changes without further notice to any products herein to improve reliability, function or design. QT-BRIGHTEK does not assume any liability arising out of the application or use of any product or circuit described herein; neither does it convey any license under its patent rights, nor the rights of others.

**Life Support Policy**

QT-BRIGHTEK's products are not authorized for use as critical components in life support devices or systems without the express written approval of QT-BRIGHTEK. As used herein:

1. Life support devices or systems are devices or systems which, (a) are intended for surgical implant into the body, or (b) support or sustain life, and (c) whose failure to perform when properly used in accordance with instructions for use provided in the labeling, can be reasonably expected to result in a significant injury of the user.
2. A critical component in any component of a life support device or system whose failure to perform can be reasonably expected to cause the failure of the life support device or system, or to affect its safety or effectiveness.

Product: QBHP686-IR4D	Date: June 23, 2020	Page 9 of 9
	Version# 1.0	