



SOT-223



Pin Definition:

1. Base
2. Collector
3. Emitter

PRODUCT SUMMARY

BV_{CBO}	-500V
BV_{CEO}	-500V
I_C	-150mA
$V_{CE(SAT)}$	-0.5V @ $I_C / I_B = -50mA / -10mA$

Features

- Low Saturation Voltages
- Excellent gain characteristics specified up to -50mA

Structure

- Epitaxial Planar Type
- PNP Silicon Transistor

Ordering Information

Part No.	Package	Packing
TSA874CW RPG	SOT-223	2.5Kpcs / 13" Reel

Note: "G" denotes for Halogen Free

Absolute Maximum Rating (Ta = 25°C unless otherwise noted)

Parameter	Symbol	Limit	Unit
Collector-Base Voltage	V_{CBO}	-500	V
Collector-Emitter Voltage	V_{CEO}	-500	V
Emitter-Base Voltage	V_{EBO}	-5	V
Collector Current	DC	-150	mA
	Pulse	-500	
Total Power Dissipation	P_{tot}	1	W
Operating Junction Temperature	T_J	+150	°C
Operating Junction and Storage Temperature Range	T_{STG}	- 55 to +150	°C

Electrical Specifications (Ta = 25°C unless otherwise noted)

Parameter	Conditions	Symbol	Min	Typ	Max	Unit
Collector-Base Breakdown Voltage	$I_C = -100\mu A, I_E = 0$	BV_{CBO}	-500	--	--	V
Collector-Emitter Breakdown Voltage	$I_C = -10mA, I_B = 0$	BV_{CEO}	-500	--	--	V
Emitter-Base Breakdown Voltage	$I_E = -100\mu A, I_C = 0$	BV_{EBO}	-5	--	--	V
Collector Cutoff Current	$V_{CB} = -120V, I_E = 0$	I_{CBO}	--	--	-100	nA
Emitter Cutoff Current	$V_{EB} = -6V, I_C = 0$	I_{EBO}	--	--	-100	nA
Collector-Emitter Saturation Voltage	$I_C = -20mA, I_B = -2mA$	$V_{CE(SAT) 1}$	--	--	-0.2	V
	$I_C = -50mA, I_B = -10mA$	$V_{CE(SAT) 2}$	--	--	-0.5	
Base-Emitter Saturation Voltage	$I_C = -50mA, I_B = -10mA$	$V_{BE(SAT)}$	--	--	-0.9	V
Base-Emitter on Voltage	$V_{CE} = -10V, I_C = -50mA$	$V_{BE(ON)}$	--	--	-0.9	V
DC Current Transfer Ratio	$V_{CE} = -10V, I_C = -1mA$	$h_{FE 1}$	150	--	300	
	$V_{CE} = -10V, I_C = -50mA$	$h_{FE 2}$	80	--	300	
	$V_{CE} = -10V, I_C = -100mA$	$h_{FE 3}$	--	15	--	
Transition Frequency	$V_{CE} = 10V, I_C = -100mA$	f_T	--	50	--	MHz
Output Capacitance	$V_{CB} = 20V, f = 1MHz$	C_{ob}	--	--	8	pF
Turn On Time	$V_{CE} = -100V, I_C = -50mA$	T_{on}	--	110	--	nS
Turn Off Time	$I_{B1} = -5mA, I_{B2} = -10mA$	T_{off}	--	1500	--	nS

Electrical Characteristics Curve ($T_a = 25^\circ\text{C}$, unless otherwise noted)

Figure 1. Static Characteristics

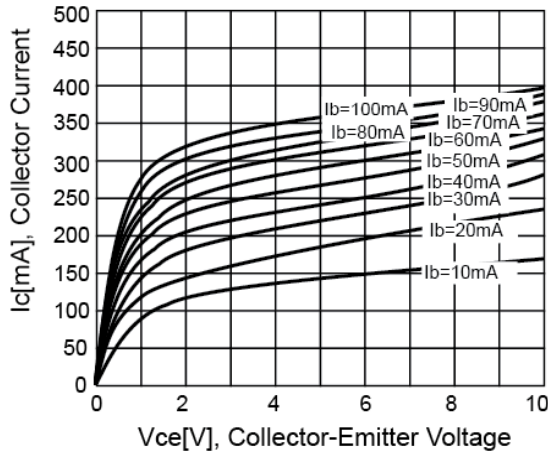

Figure 2. DC Current Gain

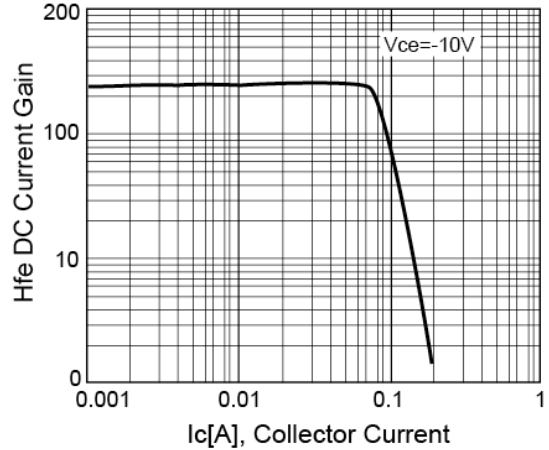

Figure 3. VCE(SAT) v.s. VBE(SAT)

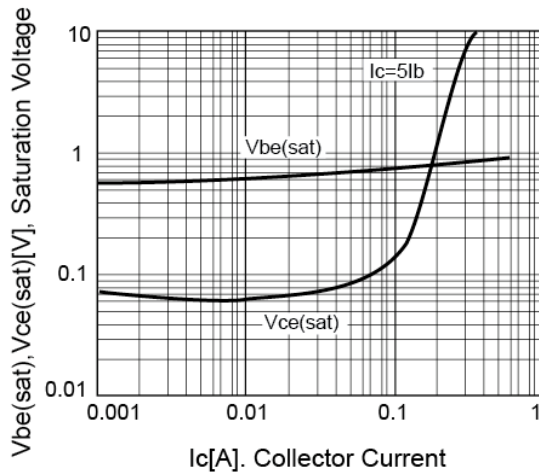

Figure 4. Power Derating

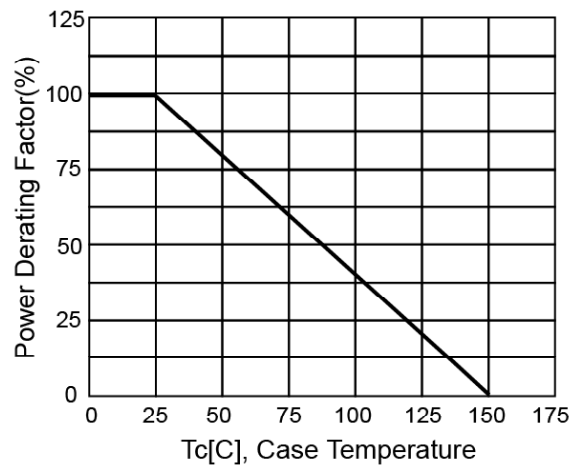
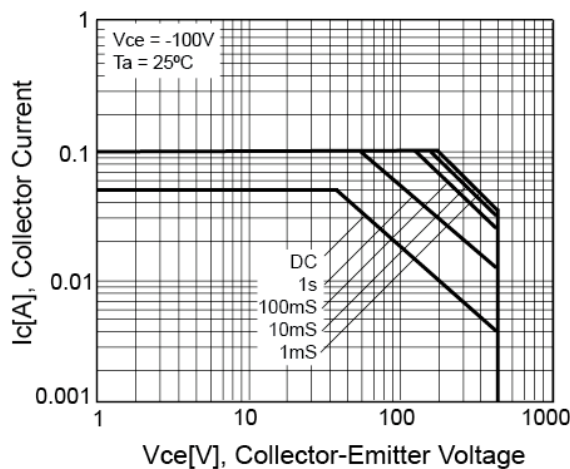
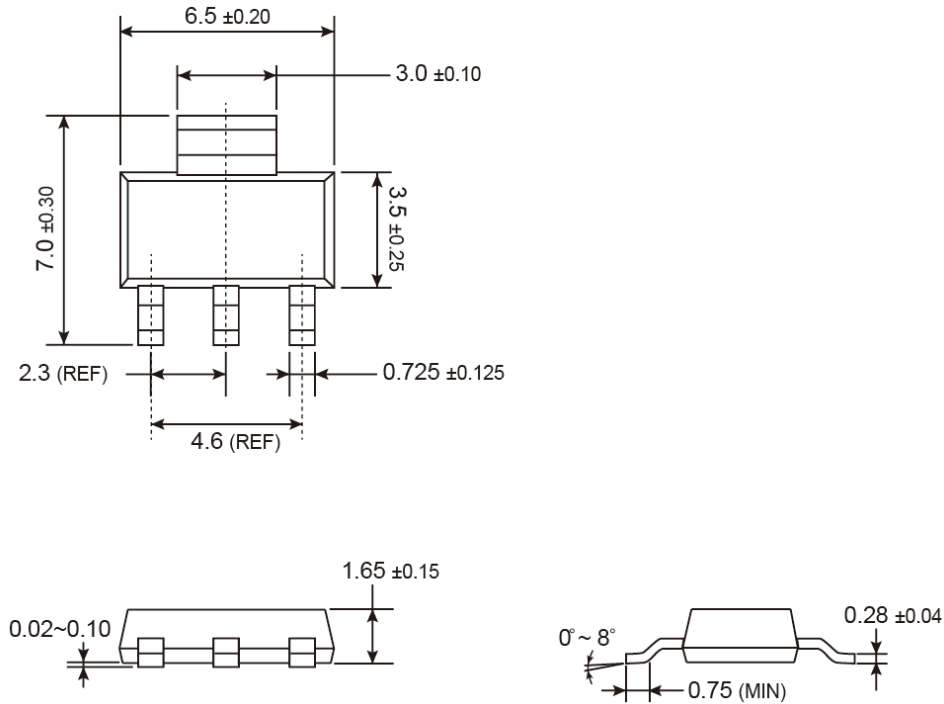

Figure 5. Safety Operation Area



SOT-223 Mechanical Drawing



Unit: Millimeters

Marking Diagram

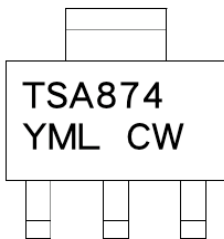

- Y** = Year Code
- M** = Month Code for Halogen Free Product
 - O** =Jan **P** =Feb **Q** =Mar **R** =Apr
 - S** =May **T** =Jun **U** =Jul **V** =Aug
 - W** =Sep **X** =Oct **Y** =Nov **Z** =Dec
- L** = Lot Code

Notice

Specifications of the products displayed herein are subject to change without notice. TSC or anyone on its behalf, assumes no responsibility or liability for any errors or inaccuracies.

Information contained herein is intended to provide a product description only. No license, express or implied, to any intellectual property rights is granted by this document. Except as provided in TSC's terms and conditions of sale for such products, TSC assumes no liability whatsoever, and disclaims any express or implied warranty, relating to sale and/or use of TSC products including liability or warranties relating to fitness for a particular purpose, merchantability, or infringement of any patent, copyright, or other intellectual property right.

The products shown herein are not designed for use in medical, life-saving, or life-sustaining applications. Customers using or selling these products for use in such applications do so at their own risk and agree to fully indemnify TSC for any damages resulting from such improper use or sale.