



specifications

CRI	Voltage	Ambient Temp (F)	Color Temp	Material	IP Rating	Efficacy	Gross Weight	Beam Angle	Warranty	Case QTY
80	100-277 ⚡	-40° - 131°	5000K	copper free aluminum housing	IP 66	140 LM / W	11.68 lbs	120°	6 years	1 pcs

select your fixture

Part Number	Color Temp	Consumption	Lumen Output	Emergency Driver	Dimensions
GI-EPA-C1500-C1D2	5000K	400W	56,000	No	18.6'x13.8'x10.2'
GI-EPA-C1500-EMC1D2	5000K	400W	56,000	Yes	18.6'x13.8'x10.2'

add your accessories*

Accessories Part Number	Description
1.) GI-ACC-EPSMA	Surface Mounting Arm
2.) GI-ACC-EPJB	Junction Box
3.) GI-ACC-EP255	25° Degree Pole Support
4.) GI-ACC-EP90S	90° Degree Pole Support

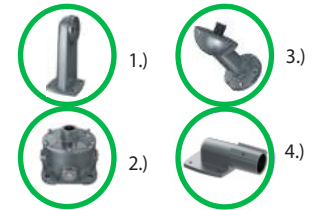

optional*

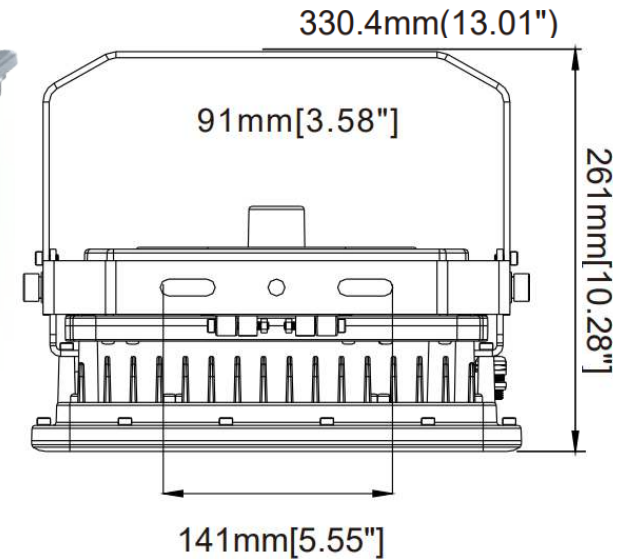

Features

- Rated for high temperatures, humidity, dust and vapor locations
- Built for a variety of purposes such as spot light, tunnel light, and general illumination in hazardous locations
- Light weight design
- Heavy duty and high impact resistance
- Various installation options for particular applications
- Dimmable

Distribution Diagram

	Center Beam fc	Beam Width	
4ft	683fc	11ft	11ft
8ft	170fc	21ft	22ft
12ft	73fc	32ft	33ft
16ft	39fc	43ft	45ft
20ft	26fc	53ft	56ft

■ Vert, Spread; 120°
■ Horiz, Spread; 120°

Not all product variations listed on this page may be DLC qualified. Visit www.designlights.org/search to confirm qualification.

