

# R7 SERIES ROCKER SWITCH

ANTI-VANDAL SWITCHES  
DETECTOR SWITCHES  
DIP SWITCHES  
KEYLOCK SWITCHES  
NAVIGATION SWITCHES  
PUSHBUTTON SWITCHES  
ROCKER SWITCHES  
ROTARY SWITCHES  
SLIDE SWITCHES  
SNAP ACTION SWITCHES  
TACTILE SWITCHES  
TOGGLE SWITCHES  
CAP OPTIONS

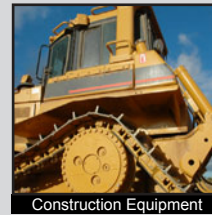

## APPLICATIONS / MARKETS



RoHS

## SPECIFICATIONS

**Contact Rating:** 20(8)A @ 125/250VAC, 50/60 Hz,  $\mu$ T55;  
16A @ 6-30VDC, 50/60 Hz,  $\mu$ T55;  
20(8)A @ 125/250VAC, 50/60 Hz,  $\mu$ T85/T55;  
16A @ 6-30VDC, 50/60 Hz,  $\mu$ T85/T55  
**Electrical Life:** 10,000 Cycles per UL61058  
**Contact Resistance:** 20m $\Omega$  Max. initial  
**Insulation Resistance:** 100 M $\Omega$  Min. @ 500VDC  
**Dielectric Strength:** 1,500VAC for 1 minute  
**Operating Temperature:** 0°C to 55°C  
**Storage Temperature:** -20°C to 85°C  
**Agency Approvals:** cURus  
**Contact Arrangement:** SP or DP up to 3 positions  
**Moisture Protection:** IP67 to front panel  
**Panel Thickness:** 1.5 - 4.5mm

## FEATURES & BENEFITS

- Rated to IP67
- UL Certified
- Ergonomic design
- Solder, faston or screw termination
- LED Illumination options
- Multiple functions
- Many actuator styles
- Custom actuator marking available

## PART NUMBER CONFIGURATOR

Series	No. of Poles	Functions	Terminals	Actuator Style**	Marking**	Lamp Type	Actuator Color**	Ratings/Temp	LED 1 Color	LED 2 Color	Lens Color**
<input type="text"/>	<input type="text"/>	<input type="text"/>	<input type="text"/>	<input type="text"/>	<input type="text"/>	<input type="text"/>	<input type="text"/>	<input type="text"/>	<input type="text"/>	<input type="text"/>	<input type="text"/>
R7	1 - SP 2 - DP	1 - On-Off 2 - On-On 3 - On-Off-On <sup>‡</sup> 4 - (On)-Off 5 - (On)-On 6 - (On)-Off-(On) 7 - (On)-Off-On 8 - On-(Off)	F - Faston 1/4" S - Solder Lug W - Screw	XX - None A1 - Hard PC A2 - Hard PC A3 - Hard PC B1 - Soft TPR B2 - Soft TPR B3 - Soft TPR B4 - Soft TPR C1 - Hard PC C2 - Hard PC C3 - Hard PC D1 - Hard PC D2 - Hard PC D3 - Hard PC E1 - Soft TPR E2 - Soft TPR E3 - Soft TPR F1 - Soft TPR F2 - Soft TPR F3 - Soft TPR	SXXX	N - None 1 - 6VDC 2 - 12VDC 3 - 24VDC 4 - 125VAC 5 - 250VAC	X - None B - Black G - Gray	B - 20(8)A @ 125/250VAC, 50/60 Hz, $\mu$ T55 D - 16A @ 6-30VDC, 50/60 Hz, $\mu$ T55 2 - 20(8)A @ 125/250VAC, 50/60 Hz, $\mu$ T85/T55 <sup>‡</sup> 4 - 16A @ 6-30VDC, 50/60 Hz, $\mu$ T85/T55 <sup>‡</sup>	N - None R - Red A - Amber G - Green	N - None R - Red A - Amber G - Green	X - None W - White G - Green

( ) denotes momentary  
‡ Function 3 is used only with ratings options 2 and 4

\*\* When creating a part number for just the switch body, choose the "X" options for those marked in red. Use all options in the main part number configurator when ordering the switch body assembled with the actuator.

**EXAMPLE ORDERING CODES:**  
Complete Switch: R712FB1-SXXXNBBNXX  
R711FB2-SXXX2BDANW  
Switch Body: R712FX-SXXX2XDGRX  
R711FX-SXXXNXDNXX  
Switch Actuator: R7F3BLKW  
R7A1BLKX

### ACTUATOR CONFIGURATOR\*

Series	Actuator Style	Actuator Color	Lens Color	Marking
<input type="text"/>	<input type="text"/>	<input type="text"/>	<input type="text"/>	<input type="text"/>
R7	XX A1 A2 D1 A3 D2 B1 D3 B2 E1 B3 E2 B4 E3 C1 F1 C2 F2 C3 F3	BLK - Black GRY - Gray	X - None W - White G - Green	SXXX

\*You can choose to order just the actuator as a separate part number

Specifications subject to change without notice



E-SWITCH®

www.e-switch.com

800.867.2717

2

# R7 SERIES ROCKER SWITCH

## BODY DIMENSIONS

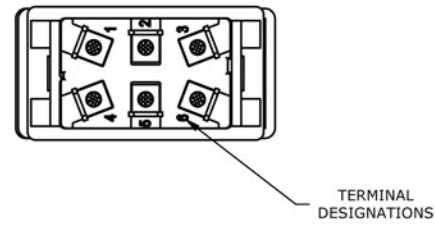
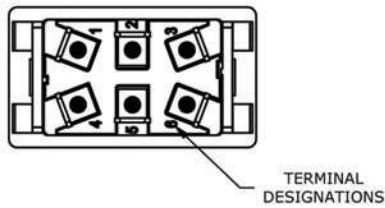
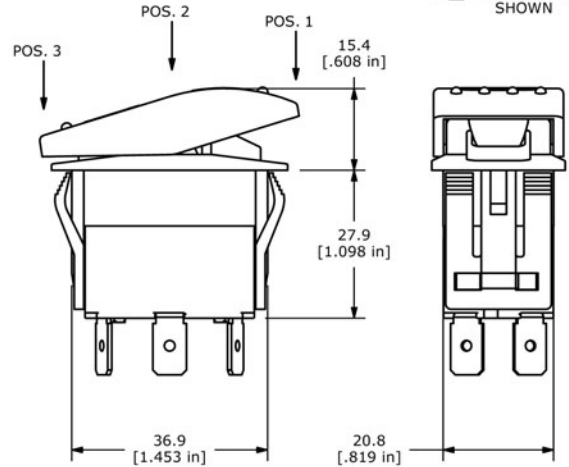
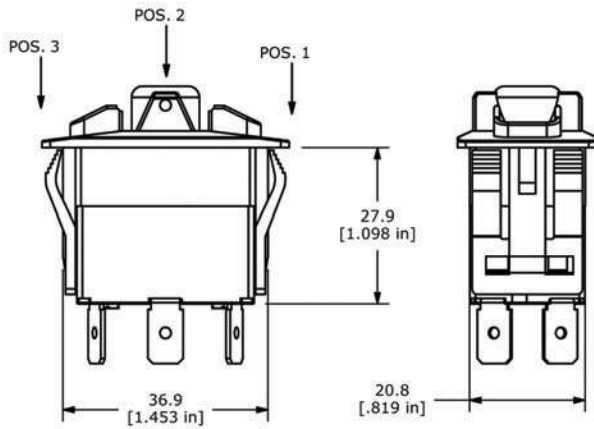
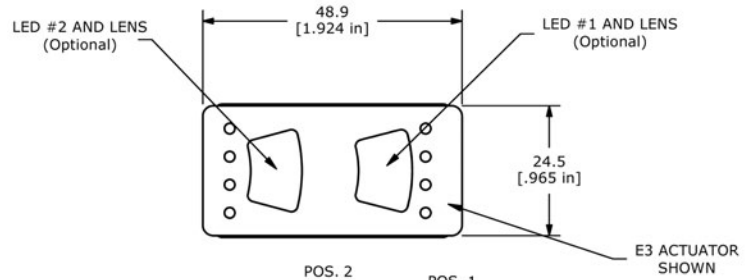
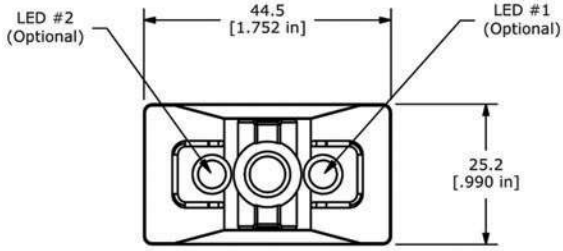

**Double Pole  
without actuator**

**Double Pole  
with actuator**

(E3 actuator shown)

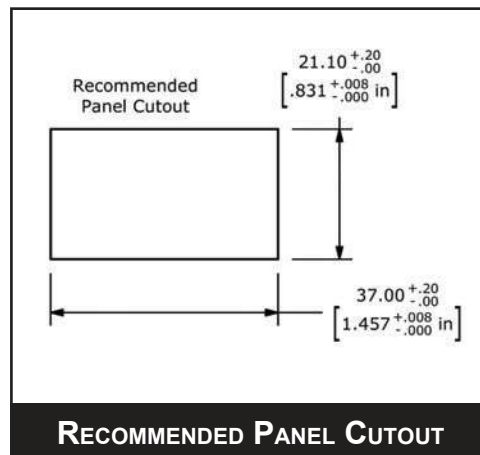

- ANTI-VANDAL SWITCHES
- DETECTOR SWITCHES
- DIP SWITCHES
- KEYLOCK SWITCHES
- NAVIGATION SWITCHES
- PUSHBUTTON SWITCHES
- ROCKER SWITCHES**
- ROTARY SWITCHES
- SLIDE SWITCHES
- SNAP ACTION SWITCHES
- TACTILE SWITCHES
- TOGGLE SWITCHES
- CAP OPTIONS

## TERMINATION OPTIONS

- ANTI-VANDAL SWITCHES
- DETECTOR SWITCHES
- DIP SWITCHES
- KEYLOCK SWITCHES
- NAVIGATION SWITCHES
- PUSHBUTTON SWITCHES
- ROCKER SWITCHES**
- ROTARY SWITCHES
- SLIDE SWITCHES
- SNAP ACTION SWITCHES
- TACTILE SWITCHES
- TOGGLE SWITCHES
- CAP OPTIONS

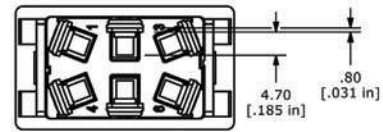
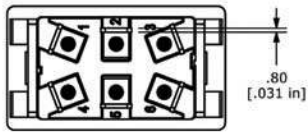
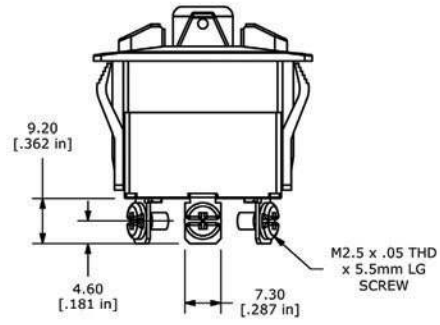
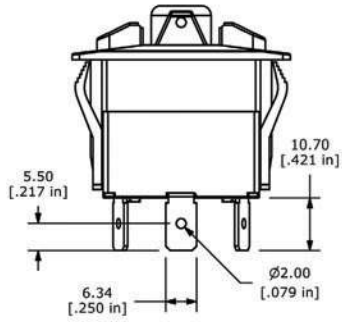
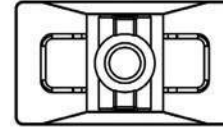
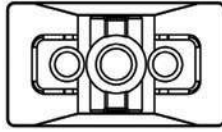

**FASTON 1/4"**

**SCREW**

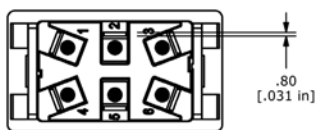
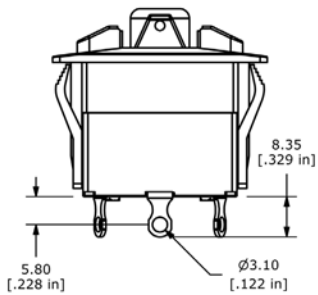
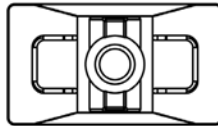

**SOLDER**



# R7 SERIES ROCKER SWITCH

## ACTUATOR OPTIONS

**A**  
Hard PC



A1



A2



A3

**B**  
Soft TPR



B1



B2



B3



B4

**C**  
Hard PC



C1



C2



C3

**D**  
Hard PC



D1



D2



D3

**E**  
Soft TPR



E1



E2

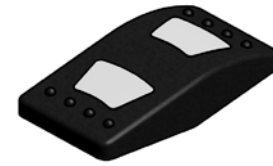

E3

**F**  
Soft TPR



F1



F2



F3

TPR = Thermal Plastic Rubber

PC = Polycarbonate

ANTI-VANDAL SWITCHES  
DETECTOR SWITCHES  
DIP SWITCHES  
KEYLOCK SWITCHES  
NAVIGATION SWITCHES  
PUSHBUTTON SWITCHES  
ROCKER SWITCHES  
ROTARY SWITCHES  
SLIDE SWITCHES  
SNAP ACTION SWITCHES  
TACTILE SWITCHES  
TOGGLE SWITCHES  
CAP OPTIONS



**E-SWITCH®**

[www.e-switch.com](http://www.e-switch.com)

800.867.2717

5

# R7 SERIES ROCKER SWITCH

## SCHEMATICS



**SPST**  
Non Illuminated

For R711, R714, R718

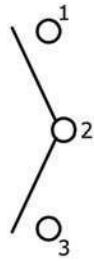

**SPDT**  
Non Illuminated

For R712, R713, R715,  
R716, R717

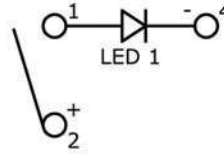

**SPST**  
with LED #1

For R711, R714, R718

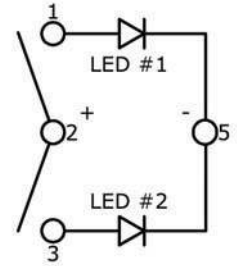

**SPDT**  
with 2 LEDs

For R712, R713, R715,  
R716, R717

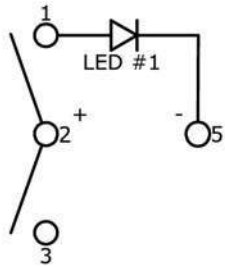

**SPDT**  
with LED #1

For R712, R713, R715,  
R716, R717

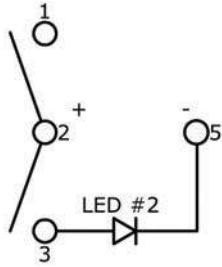

**SPDT**  
with LED #2

For R712, R713, R715,  
R716, R717

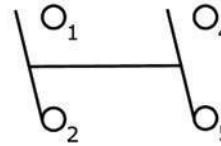

**DPST**  
Non Illuminated

For R721, R724, R728

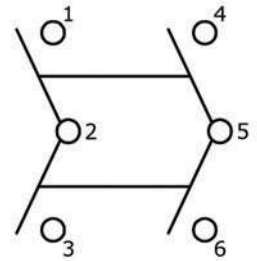

**DPDT**  
Non Illuminated

For R722, R723, R725,  
R726, R727

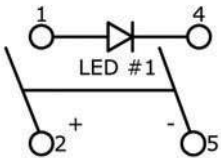

**DPST**  
with LED #1

For R721, R724, R728

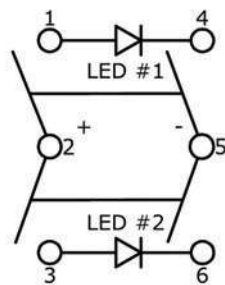

**DPDT**  
with 2 LEDs

For R722, R723, R725,  
R726, R727

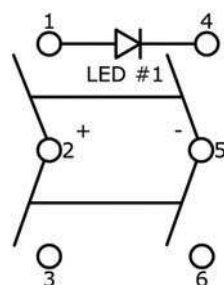

**DPDT**  
with LED #1

For R722, R723, R725,  
R726, R727

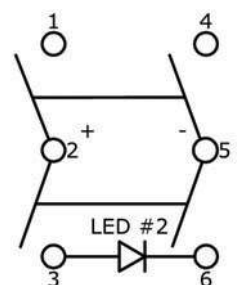

**DPDT**  
with LED #2

For R722, R723, R725,  
R726, R727

