



**Features:**

- Motor: Brushless EC
- Motor Protection: Electronically Protected
- Bearing Type: Two Ball
- Connection: UL 1007 AWG 22, 300mm Wire Leads or Terminal
- Frame Material: Plastic UL94V-0
- Impeller Material: Plastic UL94V-0
- IP54 Rated (Optional: IP55, IP56)
- Operating Temp:  
Two Ball: -20°C~70°C
- Life Expectancy:  
Two Ball: 70,000 Hours (40°C)



**Fan-S Division**

Note: FMA1-08038WBM and FMA1-08038WBL series fans have CE approval only.



Model No.	Volt.	Current	Power	Rated Speed	Maximum AirFlow		Maximum Static Pressure		Noise Level	Weight
	(VAC)	(A)	(W)	(rpm)	(CMM)	(CFM)	(InAq)	(Pa)	(dB/A)	(g)
FMA1-08038WBH*1**#	100-240	0.09	5.50	4000	1.16	40.95	0.28	70.41	31.0	162
FMA1-08038WBM*1**#	100-240	0.06	3.20	3500	1.03	36.30	0.22	54.23	27.0	162
FMA1-08038WBL*1**#	100-240	0.04	2.70	3000	0.87	30.61	0.16	40.80	24.0	162

\* Indicates "W" (Wire Leads) or "T" (Terminal)

\*\* Indicates "2" (No Special Function), "3" (Alarm), "4" (Speed Sensor)

# Indicates "-55" (IP55 Rated), "-56" (IP56 Rated), or Leave Blank (IP54 Rated)

Noise is measured at the distance of one (1) meter from the axis of intake.

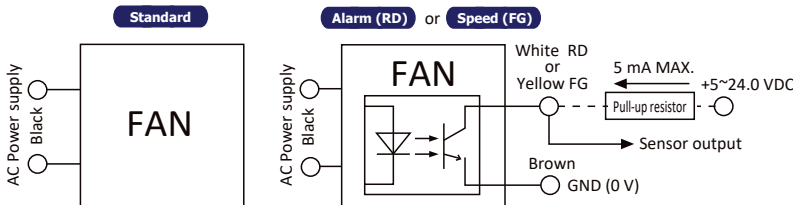
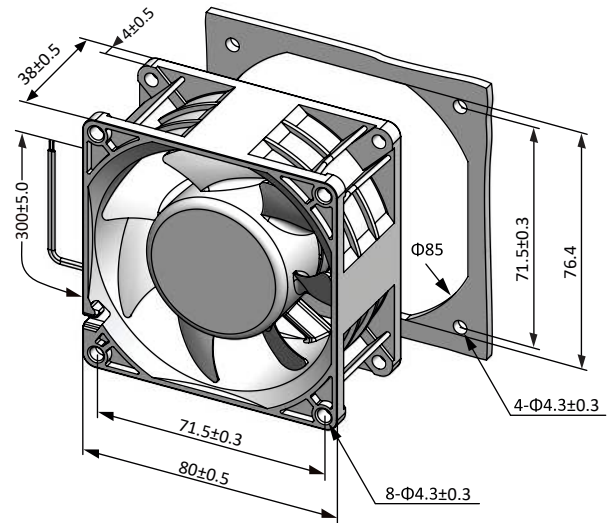
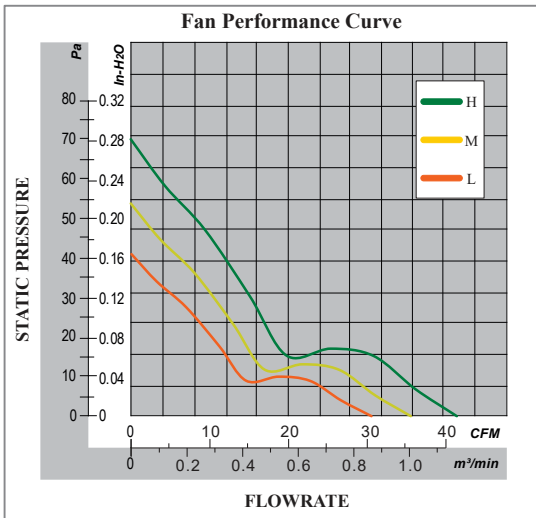

Note: Standard Qualtek EC fans have either 2 lead wires, or terminals  
Alarm (RD) or Speed Sensor (FG) fans have 4 lead wires. RD - White color, FG - Yellow color, GND - Brown