

# CH-002B

## Wall Mount Electronic Component Shelf

### Product Features:

Can be used for holding a single device or "stacked" for multiple components such as DVD players, CD players, DVRs and HD receivers

Shelf dimensions – 18" W x 13" D

Black tempered glass shelf

Can be used in conjunction with any TV wall mount to design an entertainment center

Load capacity – 25 lbs

Black powder coat finish

### Product Specifications:

*(for Architects & Engineers)*

The wall mounted component shelf for the DVR/DVD player/satellite receiver shall be the Video Mount Products (VMP) part number the CH-002B. The shelf shall be capable of mounting on a single stud or other suitable mounting surface. The shelf shall be mountable singly or assembled together with multiple CH-001B to create a wall shelf system. The shelf shall be made out of black tempered glass measuring 18" wide by 13" deep and supported by steel. The load capacity shall be 25 lbs. The self shall have a black finish.

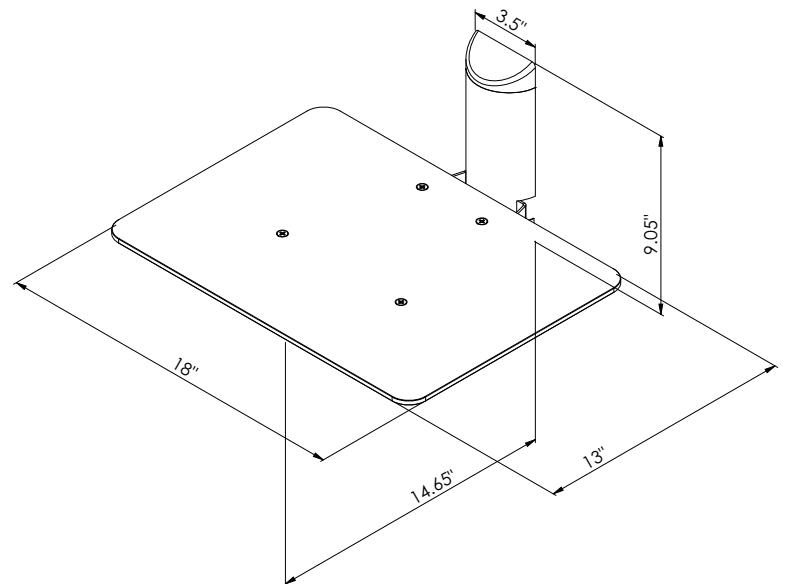

### Video Mount Products

345 Log Canoe Circle

Stevensville, MD 21666

Toll Free: 877.281.2169

Telephone: 410.643.6390

Facsimile: 410.643.6615

[www.videomount.com](http://www.videomount.com)

**VMP**  
VIDEO MOUNT PRODUCTS