

Manual Motor Starters

MMS Series



Standards and Certifications

- UL508 (Manual Motor Controller)
- UL508 (Type E self-protected Manual Motor Controller)
- CSA C22.2 No.14
- IEC 60947-2 & IEC 60947-4-2

Features

- DIN Rail and Screw Mounting
- Lockable Handle in OFF position
- Finger safe terminals
- Class 10 thermal Overload protection
- Trip test feature
- Phase failure protection
- Adjustable thermal release
- Type F combination Manual Motor Controller (with MC-Series Contactor)
- Wide range of common accessories:
 - Auxiliary contacts
 - Alarm Switch
 - Undervoltage/ Shunt Trip
 - Rotary Handle
 - Busbar
 - MC-Series Mounting Adapter

General Specifications

Maximum Voltage	600V AC
Short Circuit Current Rating (SCCR)	up to 65kA@480VAC
Rated Frequency	50/60Hz
Max Operating Frequency	25 operations/hour
Operating Temperature	-20°C (-4°F) to +60°C (140°F)
Storage Temperature	-50°C (-58°F) to +80°C (176°F)
Degree of protection	IP20
Resistance to Shock	25g
Resistance to Vibration	5 - 150Hz

Terminal Size Acceptability and Torque

Wire Type	Conductors	MMS-32H	MMS-63H	MMS-100H
Solid	1	18-8 AWG	18-2AWG	12-2/0 AWG
	2	18-10AWG	18-4AWG	12-1/0 AWG
Stranded	1	18-10AWG	18-2AWG	12-2/0 AWG
	2	18-10AWG	18-4AWG	12-1/0 AWG
Flexible	1	18-10AWG	18-4AWG	12-2/0 AWG
	2	18-10AWG	18-6AWG	12-1/0 AWG
Torque		7-22 lb-in.	26-39 lb-in.	35-53 lb-in.



Manual Motor Starters

MMS Series



UL508 Type E
E252942



MMS-32H



MMS-63H



MMS-100H

Part No.	Rated Operational Current	Thermal Release Adjustment Range	Magnetic Release Operating Current	Horsepower Rating						Interrupting Capacity [kA]		
				Single Phase		Three Phase						
				115V	230V	200V	230V	460V	575V	240V	480V	600V
MMS-32H												
MMS-32H-0.16A	0.16A	0.1...0.16A	2.1A	-	-	-	-	-	-	100	65	25
MMS-32H-0.25A	0.25A	0.16...0.25A	3.3A	-	-	-	-	-	-	100	65	25
MMS-32H-0.4A	0.4A	0.25...0.4A	5.2A	-	-	-	-	-	-	100	65	25
MMS-32H-0.63A	0.63A	0.4...0.63A	8.2A	-	-	-	-	-	-	100	65	25
MMS-32H-1.0A	1.0A	0.63...1.0A	13A	-	-	-	-	-	1/2	100	65	25
MMS-32H-1.6A	1.6A	1.0...1.6A	20.8A	-	1/10	-	-	3/4	3/4	100	65	25
MMS-32H-2.5A	2.5A	1.6...2.5A	32.5A	-	1/6	1/2	1/2	1	1 1/2	100	65	25
MMS-32H-4.0A	4.0A	2.5...4.0A	52A	1/8	1/3	3/4	3/4	2	3	100	65	25
MMS-32H-6A	6A	4...6A	78A	1/4	1/2	1	1 1/2	3	5	100	65	25
MMS-32H-8A	8A	5...8A	104A	1/3	1	2	2	5	5	100	65	25
MMS-32H-10A	10A	6...10A	130A	1/2	1 1/2	2	3	5	7 1/2	100	65	25
MMS-32H-13A	13A	9...13A	169A	1/2	2	3	3	7 1/2	10	100	65	25
MMS-32H-17A	17A	11...17A	221A	1	3	3	5	10	15	100	30	10
MMS-32H-22A	22A	14...22A	286A	1 1/2	3	5	7 1/2	15	20	100	30	10
MMS-32H-26A	26A	18...26A	338A	2	3	7 1/2	7 1/2	15	20	100	30	10
MMS-32H-32A	32A	22...32A	416A	2	5	7 1/2	10	20	30	100	30	10
MMS-32H-40A	40A	28...40A	520A	3	7 1/2	10	15	30	40	100	30	10
MMS-63H												
MMS-63H-10A	10A	6...10A	130A	1/2	1 1/2	2	3	5	7 1/2	100	65	25
MMS-63H-13A	13A	9...13A	169A	1/2	2	3	3	7 1/2	10	100	65	25
MMS-63H-17A	17A	11...17A	221A	1	3	3	5	10	15	100	50	10
MMS-63H-22A	22A	14...22A	286A	1 1/2	3	5	7 1/2	15	20	100	50	10
MMS-63H-26A	26A	18...26A	338A	2	3	7 1/2	7 1/2	15	20	100	50	10
MMS-63H-32A	32A	22...32A	416A	2	5	7 1/2	10	20	30	100	50	10
MMS-63H-40A	40A	28...40A	520A	3	7 1/2	10	10	30	30	100	50	10
MMS-63H-50A	50A	34...50A	650A	3	10	15	15	30	40	100	50	10
MMS-63H-63A	63A	45...63A	819A	5	10	20	20	40	60	100	50	10
MMS-63H-65A	65A	47...65A	845A	5	15	20	25	50	60	100	50	10
MMS-100H												
MMS-100H-17A	17A	11...17A	221A	1	3	3	5	10	15	100	65	25
MMS-100H-22A	22A	14...22A	286A	1 1/2	3	5	7 1/2	15	20	100	65	25
MMS-100H-26A	26A	18...26A	338A	2	3	7 1/2	7 1/2	15	20	100	65	25
MMS-100H-32A	32A	22...32A	416A	2	5	7 1/2	10	20	30	100	65	20
MMS-100H-40A	40A	28...40A	520A	3	7 1/2	10	10	30	30	100	65	20
MMS-100H-50A	50A	34...50A	650A	3	10	15	15	30	40	100	65	20
MMS-100H-63A	63A	45...63A	819A	5	10	20	20	40	60	100	50	10
MMS-100H-75A	75A	55...75A	975A	5	15	20	25	50	60	100	50	10
MMS-100H-90A	90A	70...90A	1170A	7 1/2	20	25	30	60	75	100	50	10
MMS-100H-100A	100A	80...100A	1300A	10	20	30	30	75	100	100	50	10

Drawings and other technical information can be found on page 24-25.

Accessories

Manual Motor Starter
- MMS Series



FX...



Auxiliary Contacts

Part No.	Poles	Configuration	Mounting
FX-20	2	2NO	Front
FX-11	2	1NO/1NC	Front
FX-02	2	2NC	Front
LX-20	2	2NO	Side
LX-11	2	1NO/1NC	Side
LX-02	2	2NC	Side

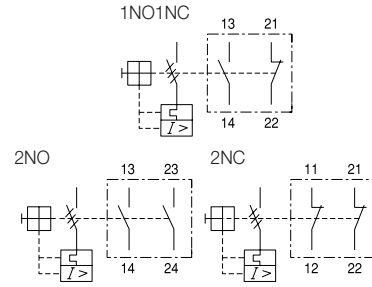

Connection Diagrams FX

LAM...



Alarm Contacts

Part No.	Poles	Configuration	Mounting
LA-20	Any Trip	2NO	Side
LA-11	Any Trip	1NO/1NC	Side
LA-02	Any Trip	2NC	Side
LAM-20	Magnetic Trip	2NO	Side
LAM-11	Magnetic Trip	1NO/1NC	Side
LAM-02	Magnetic Trip	2NC	Side

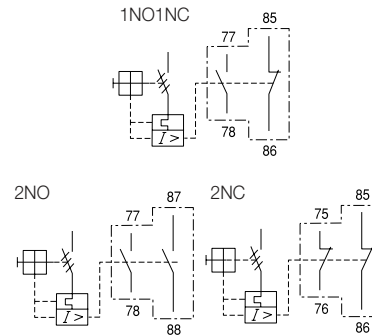

Connection Diagrams LAM

RS...



Shunt Trips*

Part No.	Control Voltage	
	50 Hz	60Hz
RS-28V	24VAC	28VAC
RS-120V	110VAC	120VAC
RS-220V	200VAC	200-220VAC
RS-260V	220-230VAC	240-260VAC
RS-277V	240VAC	277VAC
RS-440V	380-400VAC	440-460VAC
RS-480V	415-440VAC	460-480VAC

*cannot be used with RU or RUX

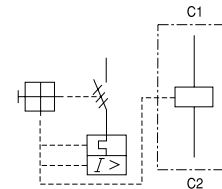

Connection Diagrams RS

RU...



Undervoltage Trips**

Part No.	Control Voltage	
	50 Hz	60Hz
RU-28V	24VAC	28VAC
RU-120V	110VAC	120VAC
RU-220V	200VAC	200-220VAC
RU-260V	220-230VAC	240-260VAC
RU-277V	240VAC	277VAC
RU-440V	380-400VAC	440-460VAC
RU-480V	415-440VAC	460-480VAC

**cannot be used with RS or RUX

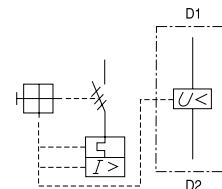

Connection Diagrams RU

RUX...



Undervoltage Trips with Switches*** includes 2NO Auxiliary Contacts

Part No.	Control Voltage	
	50 Hz	60Hz
RUX-28V	24VAC	28VAC
RUX-120V	110VAC	120VAC
RUX-220V	200VAC	200-220VAC
RUX-260V	220-230VAC	240-260VAC
RUX-277V	240VAC	277VAC
RUX-440V	380-400VAC	440-460VAC
RUX-480V	415-440VAC	460-480VAC

***cannot be used with RS or RU

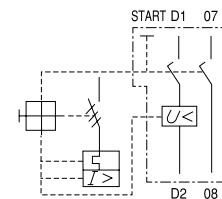

Connection Diagrams RUX

Accessories

Manual Motor Starter
- MMS Series



Altech Corp.[®]



Extended Handles

- Lockable in ON/ OFF position
- IP65 protection

Part No.	MMS-Type	Shaft Length
MEH-32-115	MMS-32H	115mm (4.53in.)
MEH-32-315	MMS-32H	315mm (12.4in.)
MEH-63-115	MMS-63H	115mm (4.53in.)
MEH-63-315	MMS-63H	315mm (12.4in.)
MEH-100-115	MMS-100H	115mm (4.53in.)
MEH-100-315	MMS-100H	315mm (12.4in.)



Busbars

Part No.	MMS Type	No, MMS	Rated Current
PB-322	MMS-32H	2	63A
PB-323	MMS-32H	3	63A
PB-632	MMS-63H	2	108A
PB-633	MMS-63H	3	108A

Insulation Cap

Part No.	Busbar Type
PBPC-32	PB-32x
PBPC-63	PB-63x



Insulated Enclosure

- IP65 protection

Part No.	MMS Type
EPH-32	MKMS-32H



Dial Cover

Dial Cover

to protect set value
from unintended operation
(for all types)

Part No.
DIAL COVER



Insulation Barrier

to increase creepage
and clearance distance
(for MMS-100H only)

Part No.
IB100

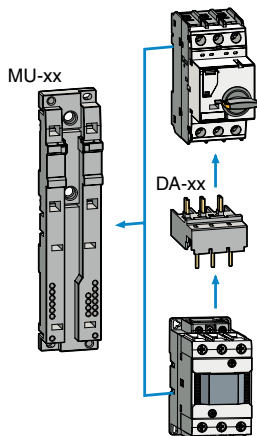

Direct Adapters and Mounting Units

- Connect MMS directly with Metasol or Mini Contactor
- Type F combination Motor Controllers consisting of Type E MMS device with MC Series contactor

Part No.	MMS Type	Combined Contactor Type	Mounting Unit
DA-16HA	MMS-32H	Mini Contactor GMC-6M...12M AC	MU-45
DA-16HD	MMS-32H	Mini Contactor GMC-6M...12M AC	MU-45
DA-22HA	MMS-32H	MC-9B...22B AC	MU-45
DA-22HD	MMS-32H	MC-9B...22B DC	MU-45
DA-32HA	MMS-32H	MC-32A...40A AC	MU-45
DA-32HD	MMS-32H	MC-32A...40A DC	MU-45
DA-63A	MMS-63H	MC-50A...65A AC	MU-55
DA-63D	MMS-63H	MC-50A...65A DC	MU-55
DA-95A	MMS-100H	MC-75A...100A AC	MU-70
DA-95D	MMS-100H	MC-75A...100A DC	MU-70

Specifications

MMS Series

Trip Curves

MMS-32H

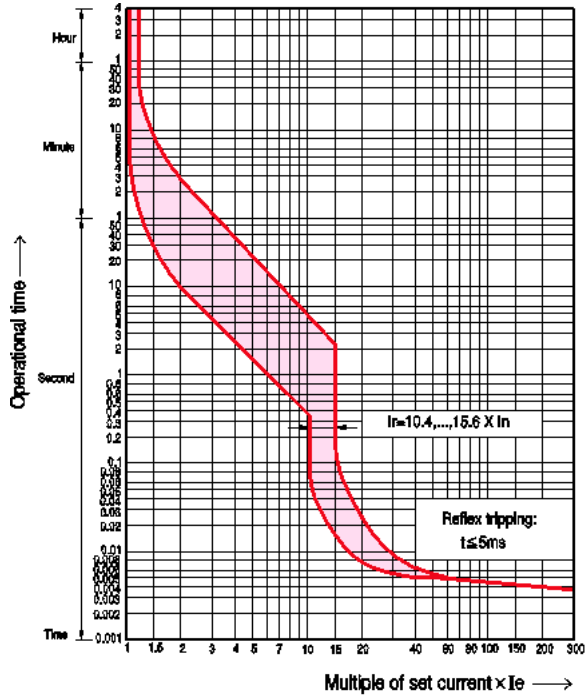

MMS-63H, MMS-100H

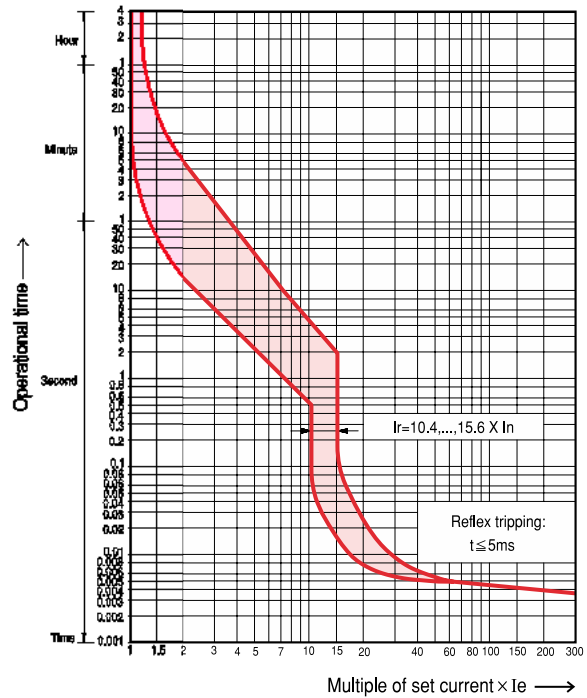

Thermal Short Circuit Limit

MMS-32H

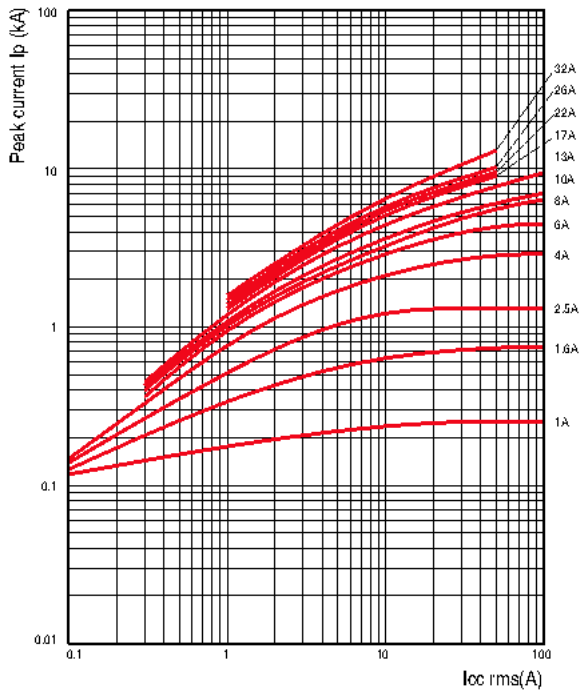

MMS-63H

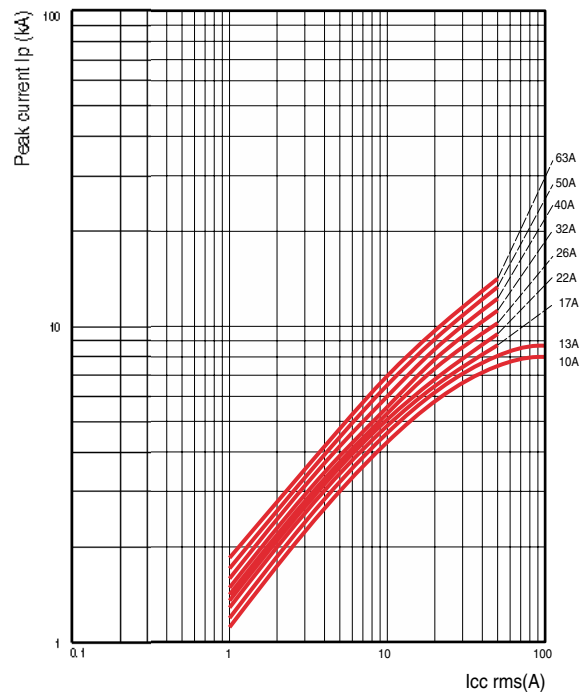

Specifications

MMS Series

- 1) Side auxiliary switch
- 2) Side magnetic trip alarm switch
- 3) Side shunt release or Side undervoltage release
- 4) Front auxiliary switch
- 5) Handle lock in OFF position (± 5mm)
- 6) Push-in Lugs for screw mounting
- 7) 35mm standard mounting rail acc. to EN 50 022

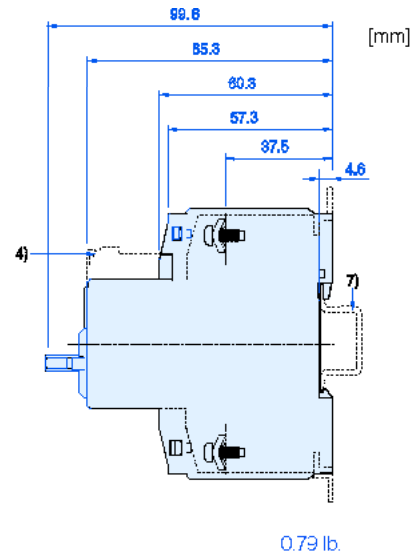
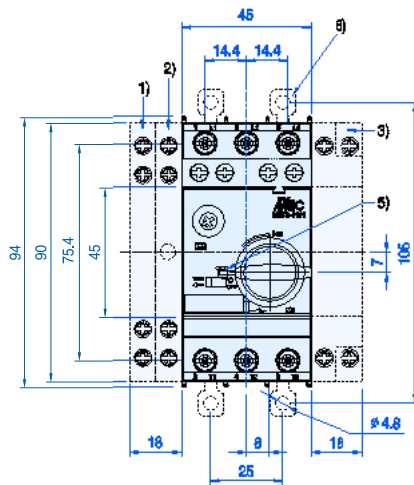

- 1) Side auxiliary switch
- 2) Side magnetic trip alarm switch
- 3) Side shunt release or Side undervoltage release
- 4) Front auxiliary switch
- 5) Handle lock in OFF position (± 5mm)
- 6) 35mm standard mounting rail acc. to EN 50 022

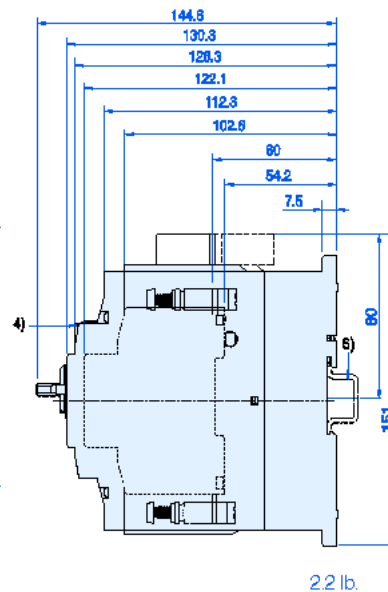
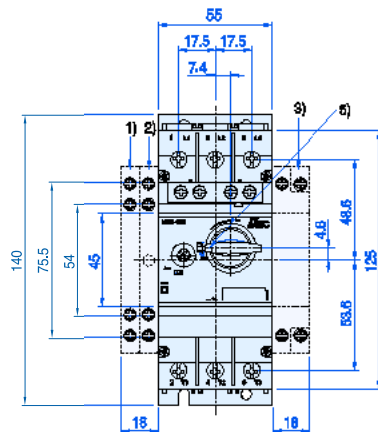

- 1) Side auxiliary switch
- 2) Side magnetic trip alarm switch
- 3) Side shunt release or Side undervoltage release
- 4) Front auxiliary switch
- 5) Handle lock in OFF position (± 5mm)
- 6) 35mm standard mounting rail acc. to EN 50 022
- 7) 75mm standard mounting rail acc. to EN 50 023
- 8) 4mm hexagon socket screw

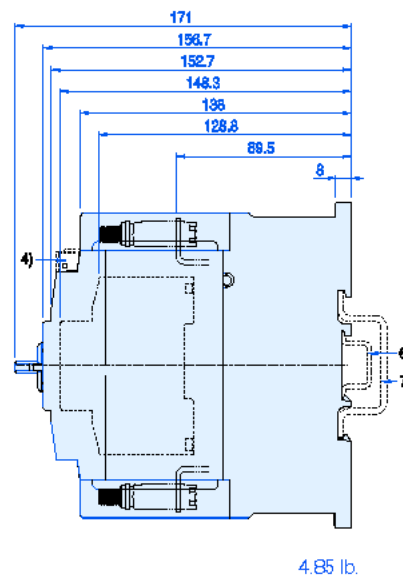
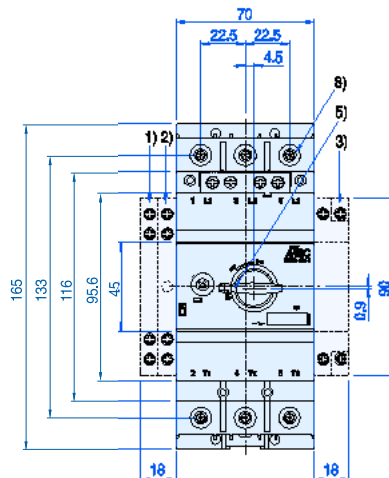

Dimensions in mm (to convert to inches multiply by 0.03937).