



TFT LCD Module

Product Specification

DT070CTFT-TS

**7.0" (800(RGB) x 480 DOTS) TFT Module
with Resistive Touch Panel**

January 2, 2018

Remark:

Contents in this document are subject to change without notice. No part of this document may be reproduced or transmitted in any form or by any means, electronic or mechanical, for any purpose, without the express written permission of Displaytech Ltd.

Displaytech Ltd.

Tel: (852) 2311 2080 ; Fax: (852) 2722 6998 ; Email: sales@displaytech.com.hk

Address: 31E Billion Plaza 2, No. 10 Cheung Yue Street, Cheung Sha Wan, Kowloon,
Hong Kong.

Website: <http://www.displaytech.com.hk>

Revision Record

| REV | CHANGES | DATE |
|-------------------------------|----------------|-------------|
| 1.0 (Ref. 1.0 20171211) | First release | Jan 2, 2018 |
| | | |
| | | |
| | | |
| | | |
| | | |
| | | |
| | | |
| | | |
| | | |
| | | |

Table of Content

| | |
|--|-----------|
| Revision Record | 1 |
| 1. Scope | 3 |
| 2. Application | 3 |
| 3. General Information..... | 3 |
| 4. Outline Drawing | 4 |
| 5. Interface Signals | 5 |
| 6. Absolute Maximum Ratings..... | 6 |
| 6.1 Electrical absolute maximum ratings | 6 |
| 6.2 Environment conditions..... | 6 |
| 7. Electrical Specifications | 7 |
| 7.1 Electrical characteristics | 7 |
| 7.2 Current consumption | 7 |
| 7.3 LED backlight..... | 7 |
| 8. Command / AC Timing | 7 |
| 8.1 AC Electrical Characteristics..... | 7 |
| 8.2 Input Clock and Data Timing Diagram..... | 8 |
| 8.3 Timing | 8 |
| 8.4 Data Input Format..... | 8 |
| 8.5 Power ON/OFF Sequence | 9 |
| 9. Optical Specification | 10 |
| 10. Environmental / Reliability Tests..... | 12 |
| 11. Precautions for Use of LCD Modules..... | 12 |
| 11.1 Safety | 12 |
| 11.2 Handling | 12 |
| 11.3 Static electricity | 13 |
| 11.4 Storage | 13 |
| 11.5 Cleaning..... | 13 |
| 11.6 Cautions for installing and assembling..... | 13 |

1. Scope

This data sheet is to introduce the specification of DT070CTFT-TS, active matrix TFT module. It is composed of a color TFT-LCD panel, driver ICs, FPC, resistive touch panel and backlight unit. The 7.0" display area contains 800(RGB) x 480 pixels.

2. Application

Digital equipment which need color display, mobile navigator/video systems.

3. General Information

| Item | Contents | Unit |
|-------------------------------|------------------------------|---------|
| Size | 7.0 | inch |
| Resolution | 800(RGB) x 480 | / |
| Interface | RGB 24-bit | / |
| Technology Type | a-Si TFT | / |
| Pixel Pitch | 0.1926 x 0.1790 | mm |
| Pixel Configuration | R.G.B. Stripe | |
| Outline Dimension (W x H x D) | 165.0 x 100.0 x 6.9 | mm |
| Active Area | 154.08 x 85.92 | mm |
| Display Mode | Transmissive, Normally White | / |
| Viewing Direction | 12 | O'clock |
| Backlight Type | LED | / |
| Controller/ driver | HX8264E & HX8664B | / |

4. Outline Drawing

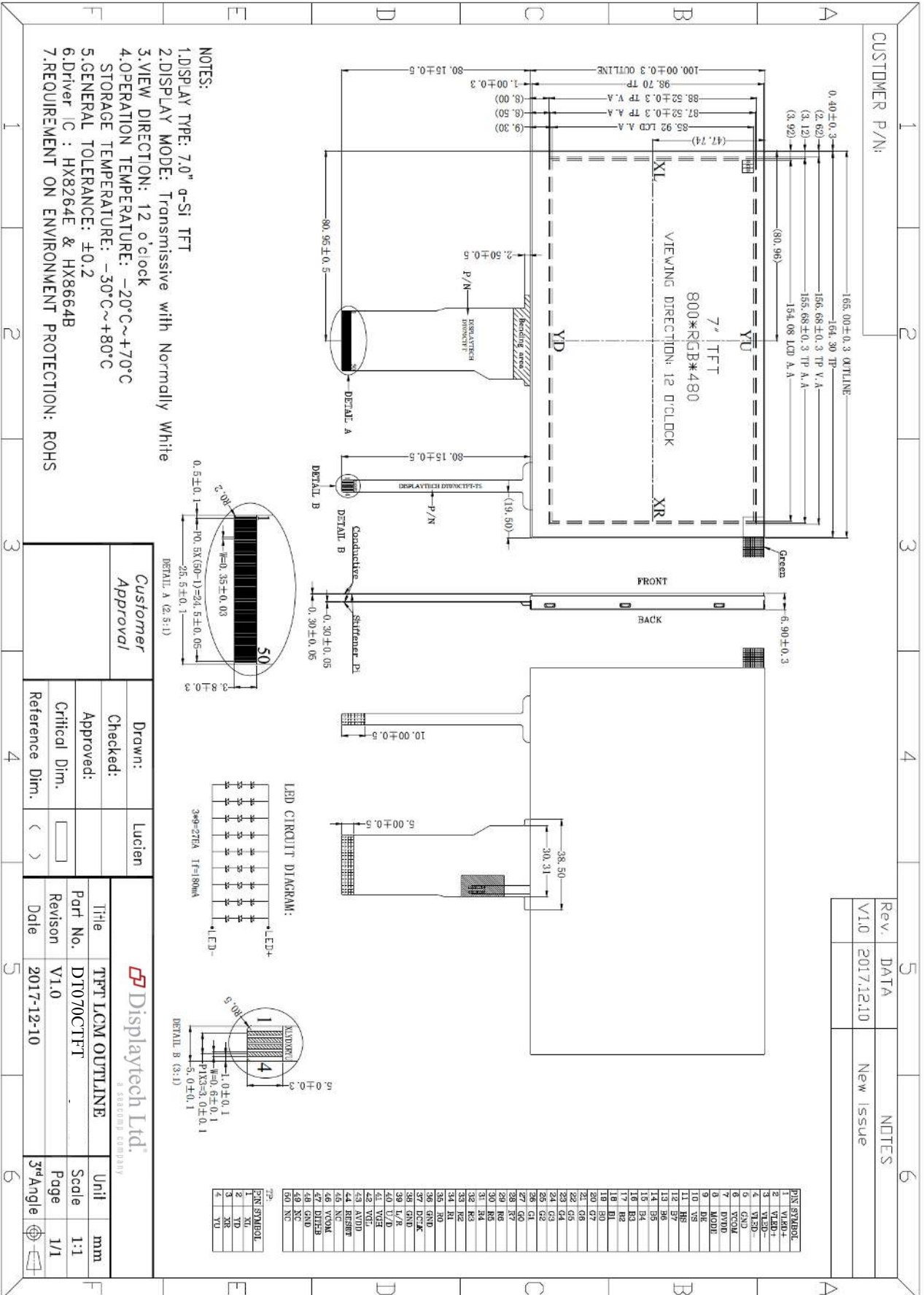

5. Interface Signals

5.1 Interface Signal for display

| No | Symbol | Description | Remark |
|----|--------|-----------------------------------|-----------|
| 1 | VLED+ | Power for LED backlight (Anode) | |
| 2 | VLED+ | Power for LED backlight (Anode) | |
| 3 | VLED- | Power for LED backlight (Cathode) | |
| 4 | VLED- | Power for LED backlight (Cathode) | |
| 5 | GND | Power Ground | |
| 6 | VCOM | Common voltage | |
| 7 | DVDD | Power for digital circuit | |
| 8 | MODE | DE/SYNC mode select | Note 1 |
| 9 | DE | Data input enable | |
| 10 | VS | Vertical sync input | |
| 11 | HS | Horizontal sync input | |
| 12 | B7 | Blue data (MSB) | Note 2 |
| 13 | B6 | Blue data | |
| 14 | B5 | Blue data | |
| 15 | B4 | Blue data | |
| 16 | B3 | Blue data | |
| 17 | B2 | Blue data | |
| 18 | B1 | Blue data | |
| 19 | B0 | Blue data (LSB) | Note 2 |
| 20 | G7 | Green data (MSB) | Note 2 |
| 21 | G6 | Green data | |
| 22 | G5 | Green data | |
| 23 | G4 | Green data | |
| 24 | G3 | Green data | |
| 25 | G2 | Green data | |
| 26 | G1 | Green data | |
| 27 | G0 | Green data (LSB) | Note 2 |
| 28 | R7 | Red data (MSB) | Note 2 |
| 29 | R6 | Red data | |
| 30 | R5 | Red data | |
| 31 | R4 | Red data | |
| 32 | R3 | Red data | |
| 33 | R2 | Red data | |
| 34 | R1 | Red data | |
| 35 | B0 | Red data (LSB) | Note 2 |
| 36 | GND | Power Ground | |
| 37 | DCLK | Sample clock | Note 3 |
| 38 | GND | Power Ground | |
| 39 | L/R | Left / Right selection | Note 4, 5 |
| 40 | U/D | Up / Down selection | Note 4, 5 |
| 41 | VGH | Gate ON Voltage | |
| 42 | VGL | Gate OFF Voltage | |
| 43 | AVDD | Power for analog circuits | |
| 44 | RESET | Global reset pin | Note 6 |
| 45 | NC | No connection | |
| 46 | VCOM | Common voltage | |
| 47 | DITHB | Dithering function | Note 7 |
| 48 | GND | Power Ground | |
| 49 | NC | No connection | |
| 50 | NC | No connection | |

The recommended connector: Hirose FH19SC-50S-0.5SH, FH12S-50S-0.5SH; or Molex 0512965093, 0512965094; or equivalent

Note 1: DE/SYNC mode select. Normally pull high.

When select DE mode, MODE="1", VS and HS must pull high.

When select SYNC mode, MODE="0", DE must be grounded.

Note 2: When input 18 bits RGB data, the two low bits of R, G and B data must be grounded.

Note 3: Data shall be latched at the falling edge of DCLK.

Note 4: Selection of scanning mode

| Setting of scan control input | | Scanning direction |
|-------------------------------|------|---------------------------|
| U/P | L/R | |
| GND | DVDD | Up to down, left to right |
| DVDD | GND | Down to up, right to left |
| GND | GND | Up to down, right to left |
| DVDD | DVDD | Down to up, left to right |

Note 5: Definition of scanning direction.

Refer to the figure as below:

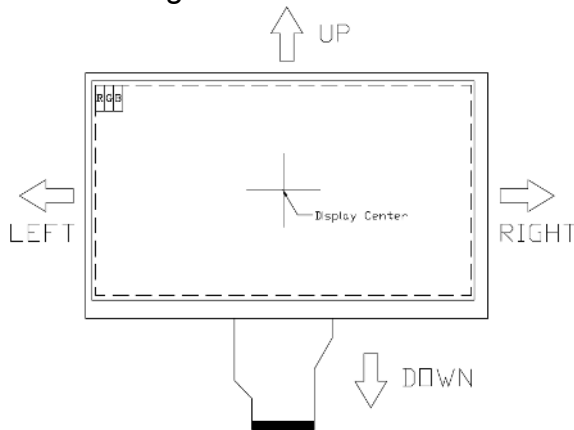

Note 6: Global reset pin. Active low to enter reset state. Suggest to connect with an RC reset circuit for stability. Normally pull high.

Note 7: Dithering function enable control, normally pull high.

When DITHB="1", Disable internal dithering function,

When DITHB="0", Enable internal dithering function,

5.2 Touch Screen Interface

| No | Symbol | Description |
|----|--------|------------------------|
| 1 | XL | X left channel output |
| 2 | YD | Y down channel output |
| 3 | XR | X right channel output |
| 4 | YU | Y up channel output |

6. Absolute Maximum Ratings

6.1 Electrical absolute maximum ratings

| Parameter | Symbol | MIN | MAX | Unit | Remark |
|---------------|--------|--------|------|------|--------|
| Power Voltage | VCC | -0.5 | +5.0 | V | |
| | AVDD | -0.5 | 13.5 | V | |
| | VGH | -0.3 | +42 | V | |
| | VGL | VGH-42 | +0.3 | V | |

6.2 Environment conditions

| Parameter | Symbol | MIN | MAX | Unit | Remark |
|-----------------------|--------|-----|-----|------|--------|
| Operating Temperature | TOPR | -20 | +70 | °C | |
| Storage Temperature | TSTG | -30 | +80 | °C | |

Notes:

1. When temperature is below 0°C, the response time of liquid crystal (LC) will be slower and the color of panel will be darker.
2. If module driving condition exceeds the absolute maximum ratings, permanent damaged may be resulted. If module is driven within the absolute maximum ratings but exceeded the DC characteristics, mal-function may be resulted.
3. VDD/VCC > VSS.

7. Electrical Specifications

7.1 Electrical characteristics

GND=0V, Ta=25°C

| Item | Symbol | MIN | TYP | MAX | Unit | |
|---------------------------------|------------|-----|----------|-----|----------|---|
| Digital supply voltage | VCC | - | 3.3 | - | V | |
| Analog supply voltage | AVDD | - | 10.4 | - | V | |
| Gate ON voltage | VGH | - | 16 | - | V | |
| Gate OFF voltage | VGL | - | -7 | - | V | |
| Common electrode driving signal | VCOM | 3.5 | - | 4.5 | V | |
| Logic supply voltage | DVDD | 2.8 | 3.3 | 3.6 | V | |
| Input signal voltage | Low level | VIL | 0 | - | 0.3xDVDD | V |
| | High level | VIH | 0.7xDVDD | - | DVDD | V |
| Output signal voltage | Low level | VOL | - | - | GND+0.4 | V |
| | High level | VOH | DVDD-0.4 | - | - | V |

7.2 Current consumption

| Item | Symbol | MIN | TYP | MAX | Unit | Remark |
|------------------------|---------------|-----|--------|--------|------|------------|
| Digital supply current | IDVDD | - | 3.22 | 8.70 | mA | DVDD=3.3V |
| Analog supply current | IAVDD | - | 15.69 | 23.01 | mA | AVDD=10.4V |
| Gate ON current | IVGH | - | 0.20 | 0.22 | mA | VGH=16.0V |
| Gate OFF current | IVGL | - | 0.20 | 0.22 | mA | VGL=-7.0V |
| Power consumption | Panel & Gamma | - | 177.67 | 254.65 | mW | - |
| | Backlight | - | 1.152 | 1.267 | W | - |
| | Total | - | 1.330 | 1.522 | W | - |

7.3 LED backlight

Ta=25°C

| Item | Symbol | MIN | TYP | MAX | Unit | Remark |
|-----------------|--------|-----|-----|-----|------|--------|
| Forward current | IL | - | 180 | - | mA | |
| Forward voltage | VL | - | 9.6 | - | V | |

8. Command / AC Timing

8.1 AC Electrical Characteristics

| Item | Symbol | Rating | | | Unit | Remark |
|-------------------------|--------|--------|-----|-----|------|--------------------|
| | | MIN | TYP | MAX | | |
| HS setup time | Thst | 8 | - | - | ns | |
| HS hold time | Thhd | 8 | - | - | ns | |
| VS setup time | Tvst | 8 | - | - | ns | |
| VS hold time | Tvhd | 8 | - | - | ns | |
| Data setup time | Tdsu | 8 | - | - | ns | |
| Data hold time | Tdhd | 8 | - | - | ns | |
| DE setup time | Tesu | 8 | - | - | ns | |
| DE hold time | Tehd | 8 | - | - | ns | |
| DVDD power on slew rate | TPOR | - | - | 20 | ms | From 0 to 90% DVDD |
| RESET pulse width | TRst | 1 | - | - | ms | |
| DCLK cycle time | Tcoh | 20 | - | - | ns | |
| DCLK pulse duty | Tcwh | 40 | 50 | 60 | % | |

8.2 Input Clock and Data Timing Diagram

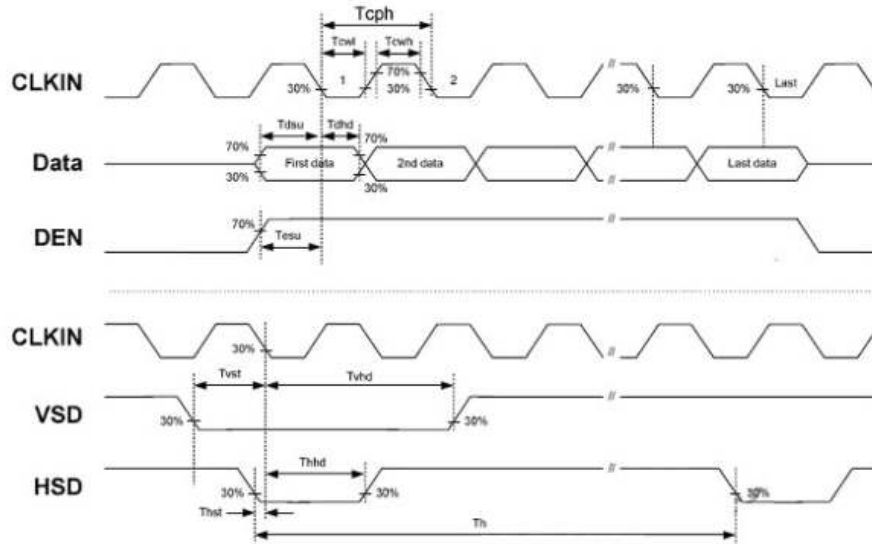

8.3 Timing

| Item | Symbol | Rating | | | Unit | Remark |
|-------------------------|--------|--------|------|------|------|--------|
| | | MIN | TYP | MAX | | |
| Horizontal display area | Thd | - | 800 | - | DCLK | |
| DCLK frequency | Fclk | 26.4 | 33.3 | 46.8 | MHz | |
| One horizontal line | Th | 862 | 1056 | 1200 | DCLK | |
| HS pulse width | Thpw | 1 | - | 40 | DCLK | |
| HS blanking | thb | 46 | 46 | 46 | DCLK | |
| HS front porch | thfp | 16 | 210 | 354 | DCLK | |

| Item | Symbol | Rating | | | Unit | Remark |
|-----------------------|--------|--------|-----|-----|------|--------|
| | | MIN | TYP | MAX | | |
| Vertical display area | Tvd | - | 480 | - | TH | |
| VS period time | Tv | 510 | 525 | 650 | TH | |
| VS pulse width | Tvpw | 1 | - | 20 | TH | |
| VS blanking | tvb | 23 | 23 | 23 | TH | |
| VS front porch | tvfp | 7 | 22 | 14 | TH | |

8.4 Data Input Format

8.4.1 Horizontal input timing diagram

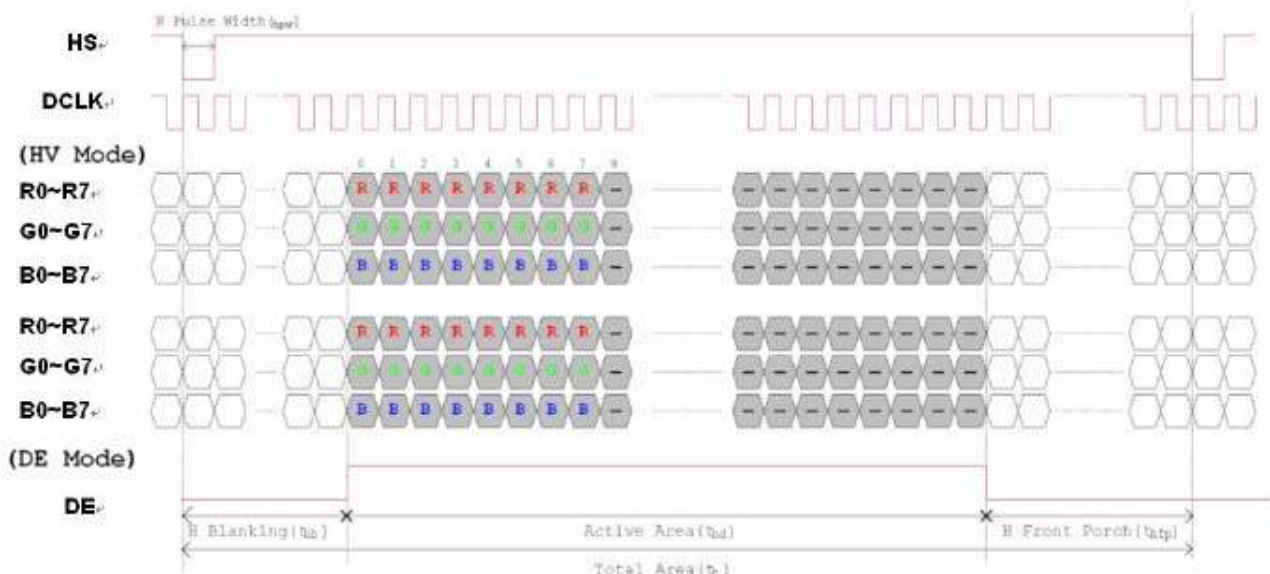

8.4.2 Vertical input timing diagram

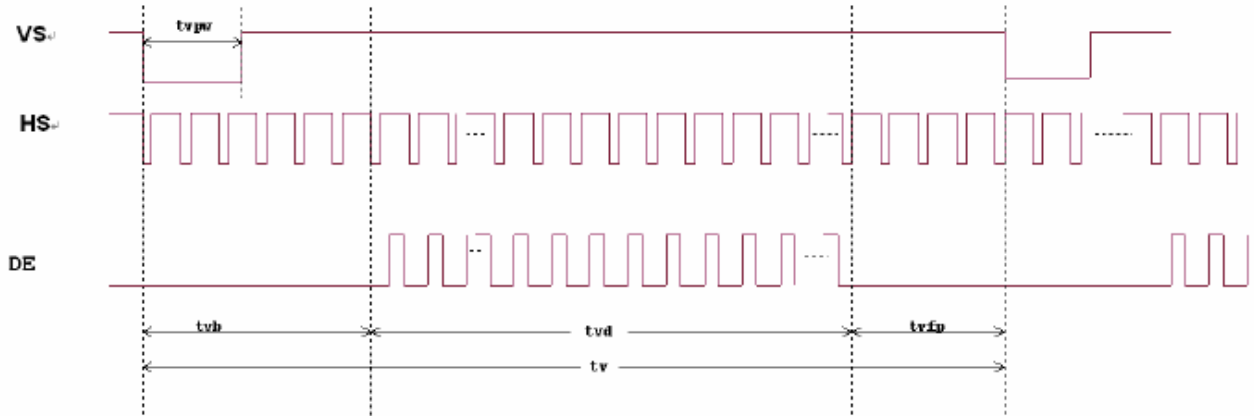

8.5 Power ON/OFF Sequence

a. Power on

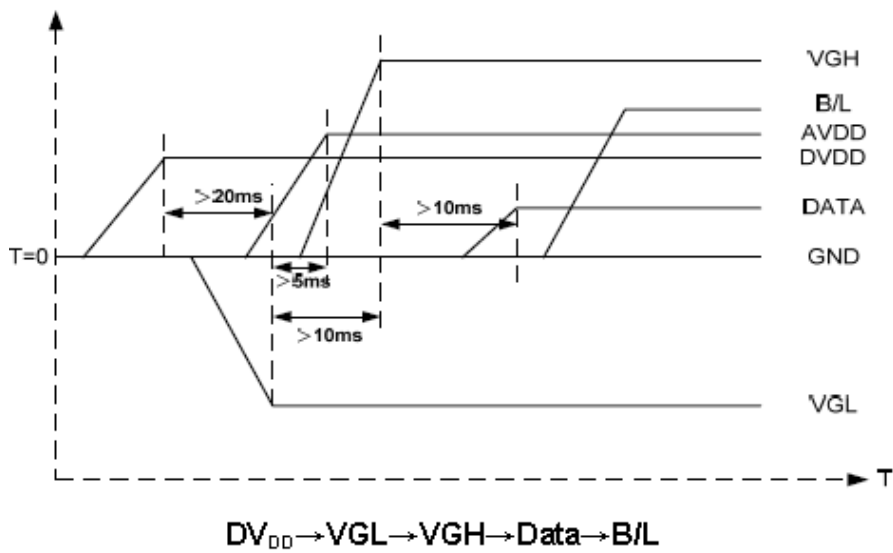

b. Power off

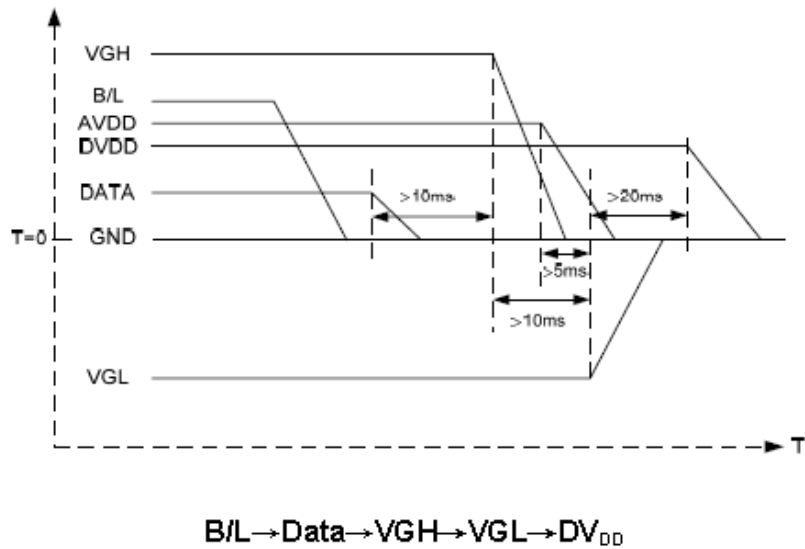

Note: Data include R0~R7, B0~B7, GO~G7, U/D, L/R, DCLK, HS, VS, DE.

9. Optical Specification

Ta=25°C

| Item | Symbol | Condition | MIN | TYP | MAX | Unit | Remark |
|----------------|------------|------------------|-----|-------|-------|-------------------|-----------|
| Contrast ratio | CR | $\theta=0^\circ$ | 400 | 500 | - | | Note 1, 2 |
| Response time | Ton | 25°C | - | 10 | 20 | ms | Note 1, 3 |
| | Toff | | - | 15 | 30 | | |
| View angles | θT | $CR \geq 10$ | 60 | 70 | - | Degree | Note 4 |
| | θB | | 50 | 60 | - | | |
| | θL | | 60 | 70 | - | | |
| | θR | | 60 | 70 | - | | |
| Chromaticity | White | Brightness is on | x | 0.267 | 0.317 | 0.367 | Note 1, 5 |
| | | | y | 0.284 | 0.334 | 0.384 | |
| | Red | | x | 0.567 | 0.617 | 0.667 | |
| | | | y | 0.305 | 0.355 | 0.405 | |
| | Green | | x | 0.289 | 0.339 | 0.389 | |
| | | | y | 0.483 | 0.533 | 0.583 | |
| | Blue | | x | 0.092 | 0.142 | 0.192 | |
| | | | y | 0.049 | 0.099 | 0.149 | |
| Luminance | L | | - | 360 | - | cd/m ² | Note 1, 6 |
| NTSC Ratio | S | | - | 50 | - | % | |
| Uniformity | U | | - | 75 | - | % | Note 1, 7 |

Test condition: DVDD=3.3V, the ambient temperature is 25°C

Note 1: Definition of optical measurement system.

Temperature = 25°C(±3°C)

LED back-light: ON, Environment brightness < 150 lx

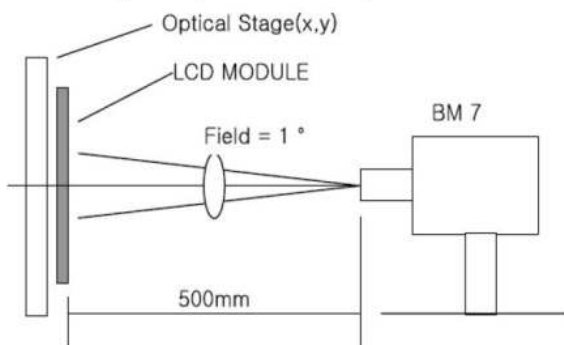

Note 2: Contrast ratio is defined as follow:

$$\text{Contrast Ratio} = \frac{\text{Surface Luminance with all white pixels}}{\text{Surface Luminance with all black pixels}}$$

Note 3: Response time is defined as follow:

Response time is the time required for the display to transition from black to white (Rise time, Tr) and from white to black (Decay Time, Tf).

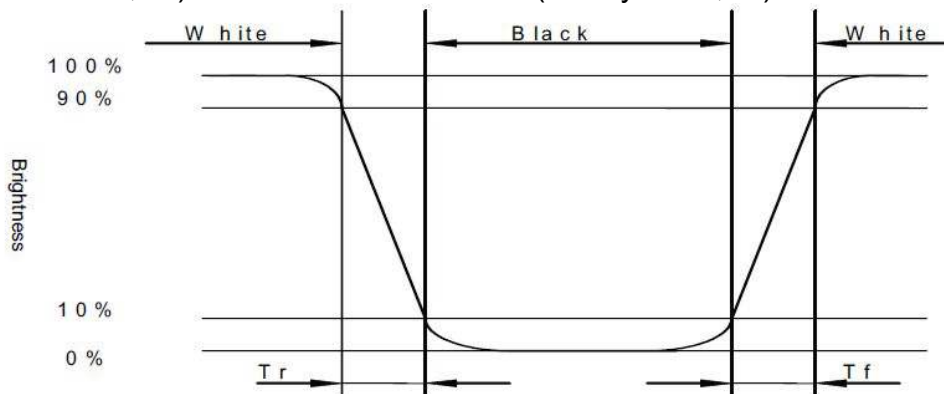

Note 4: Viewing angle range is defined as follow:

Viewing angle is measured at the center point of the LCD.

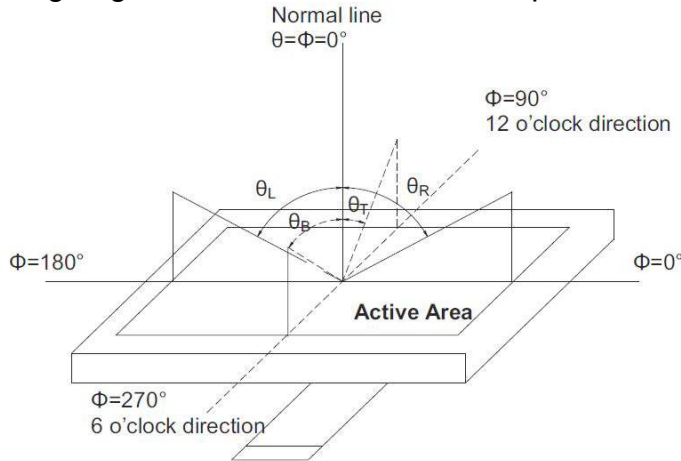

Note 5: Color chromaticity is defined as follow (CIE1931)

Color coordinates measured at center point of LCD.

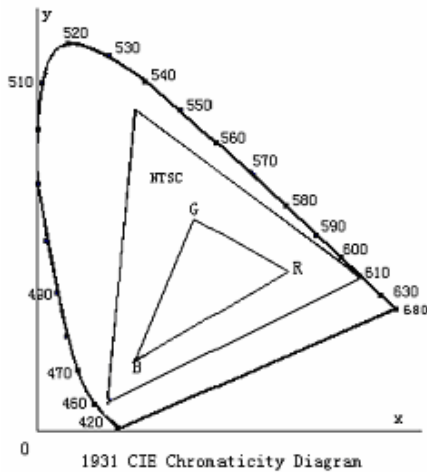

$$S = \frac{\text{area of RGB triangle}}{\text{area of NTSC triangle}} \times 100\%$$

Note 6: Luminance is defined as follow:

Luminance is defined as the brightness of all pixels “White” at the center of display area on optimum contrast.

Note 7: Luminance Uniformity is defined as follow:

Active area is divided into 9 measuring areas (Refer Fig.2). Every measuring point is placed at the center of each measuring area.

$$\text{Uniformity (U)} = \frac{\text{Minimum Luminance(brightness) in 9 points}}{\text{Maximum Luminance(brightness) in 9 points}}$$

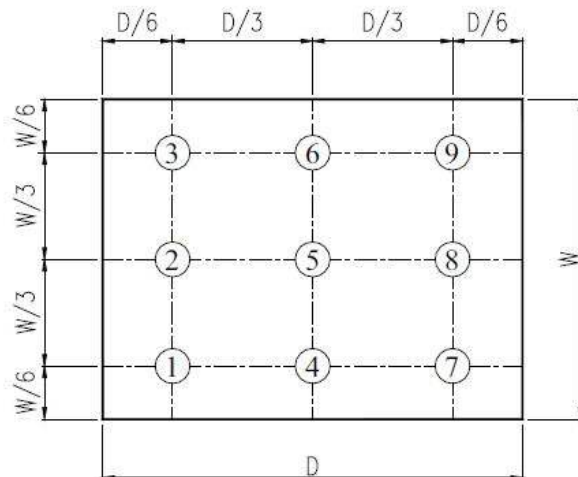

Fig. 2 Definition of uniformity

10. Environmental / Reliability Tests

| No | Test Item | Condition | Judgment Criteria |
|----|-----------------------------------|--|---|
| 1 | High Temp Operation | Ta=+70°C, 120hrs | Per table below |
| 2 | Low Temp Operation | Ta=-20°C, 120hrs | Per table below |
| 3 | High Temp Storage | Ta=+80°C, 120hrs | Per table below |
| 4 | Low Temp Storage | Ta=-30°C, 120hrs | Per table below |
| 5 | High Temp & High Humidity Storage | Ta=+60°C, 90% RH, 120hrs | Per table below (polarizer discoloration is excluded) |
| 6 | Thermal Shock (Non-operation) | -30°C 30 min ~ +80°C 30 min, Change time: 5 min, 10 cycles | Per table below |
| 7 | ESD (Operation) | C=150pF, R=330Ω, 5points/panel Air: ±8KV, 5times; Contact: ±4KV, 5 times; | Per table below |
| 8 | Vibration (Non-operation) | Frequency range: 10~55Hz, Stroke: 1.5mm Sweep: 10Hz~55Hz~10Hz 2 hours for each direction of X.Y.Z. | Per table below |
| 9 | Shock (Non-operation) | 60G 6ms, ±X,±Y,±Z 3times, for each direction | Per table below |
| 10 | Package Drop Test | Height: 80cm, 1 corner, 3 edges, 6 surfaces | Per table below |

| Inspection | Criterion (after test) |
|------------------------|---|
| Appearance | No crack on the FPC, on the LCD panel |
| Alignment of LCD panel | No bubbles in the LCD panel No other defects of alignment in active area |
| Electrical current | Within device specifications |
| Function / Display | No broken circuit, no short circuit or no black line No other defects of display |

11. Precautions for Use of LCD Modules

11.1 Safety

The liquid crystal in the LCD is poisonous. Do not put it in your mouth. If the liquid crystal touches your skin or clothes, wash it off immediately using soap and water.

11.2 Handling

- The LCD and touch panel is made of plate glass. Do not subject the panel to mechanical shock or to excessive force on its surface.
- Do not handle the product by holding the flexible pattern portion in order to assure the reliability.
- Transparency is an important factor for the touch panel. Please wear clear finger sacks, gloves and mask to protect the touch panel from finger print or stain and also hold the portion outside the view area when handling the touch panel.
- Provide a space so that the panel does not come into contact with other components.
- To protect the product from external force, put a covering lens (acrylic board or similar board) and keep an appropriate gap between them.
- Transparent electrodes may be disconnected if the panel is used under environmental conditions where dew condensation occurs.

- g. Property of semiconductor devices may be affected when they are exposed to light, possibly resulting in IC malfunctions.
- h. To prevent such IC malfunctions, your design and mounting layout shall be done in the way that the IC is not exposed to light in actual use.

11.3 Static electricity

- a. Ground soldering iron tips, tools and testers when they are in operation.
- b. Ground your body when handling the products.
- c. Power on the LCD module before applying the voltage to the input terminals.
- d. Do not apply voltage which exceeds the absolute maximum rating.
- e. Store the products in an anti-electrostatic bag or container.

11.4 Storage

- a. Store the products in a dark place at $+25^{\circ}\text{C}\pm 10^{\circ}\text{C}$ with low humidity (40% RH to 60% RH). Don't expose to sunlight or fluorescent light.
- b. Storage in a clean environment, free from dust, active gas, and solvent.

11.5 Cleaning

- a. Do not wipe the touch panel with dry cloth, as it may cause scratch.
- b. Wipe off the stain on the product by using soft cloth moistened with ethanol. Do not allow ethanol to get in between the upper film and the bottom glass. It may cause peeling issue or defective operation. Do not use any organic solvent or detergent other than ethanol.

11.6 Cautions for installing and assembling

- a. Bezel edge must be positioned in the area between the Active area and View area. The bezel may press the touch screen and cause activation if the edge touches the active area. A gap of approximately 0.5mm is needed between the bezel and the top electrode. It may cause unexpected activation if the gap is too narrow. There is a tolerance of 0.2 to 0.3mm for the outside dimensions of the touch panel and tail. A gap must be made to absorb the tolerance in the case and connector.
- b. In order to make the display assembly stable and firm, Displaytech recommends to design some supporting at the display backside, especially for the display with tape-attached touch panel, such supporting is important and essential, or else, the display may drop-off from front after some period of time.
- c. Do not display the fixed pattern for a long time because it may develop image sticking due to the LCD structure. If the screen is displayed with fixed pattern, use a screen saver.

