



Taoglas RF Connectors Adaptors and Receptacles Catalogue

Engineering Global Connectivity With You

Contents

1. Introduction	3
2. SMA Connectors & Adaptors	4
3. NMO Connectors	14
4. MCX Connectors	15
5. MMCX Connectors	15
6. FAKRA Connectors	18
7. 2.92mm Adaptors & Connectors	33
8. Receptacles	36

Taoglas makes no warranties based on the accuracy or completeness of the contents of this document and reserves the right to make changes to specifications and product descriptions at any time without notice. Taoglas reserves all rights to this document and the information contained herein. Reproduction, use or disclosure to third parties without express permission is strictly prohibited.

1. Introduction

Taoglas RF Connectors, Adaptors and Receptacles

Taoglas is a leading provider of advanced technology for a smarter world.

Our solutions include advanced components and technologies and help OEMs, enterprises, and communities to resolve the complexities of bringing digital transformation solutions to market quickly and cost effectively.

Focused on best-in-class, high-performance antenna and RF design with advanced positioning, imaging, audio and artificial intelligence technologies, Taoglas understands the importance of high-performance connections.

Taoglas connectors, adaptors and receptacles are designed to provide superior performance. They are thoroughly tested and come in all mounting types including PCB, panel, and cable, providing the most flexibility for your design and we make all our 3D and 2D drawings available to help you with integration. Our portfolio of products include SMA, FAKRA, MMCX and NMO cable mount connectors for a variety of cable types and for PCB mount requirements, we have SMA, MCX and MMCX connectors.

As 5G development continues, the diversity of applications such as high-speed communications, satellite communications, military and aerospace, alongside the ever-changing demands for higher-frequency test systems are driving coaxial cable assemblies and connectors to the next level. Our series of 2.92 connectors and adaptors, which are all cross-mateable to other industry standard connectors, support DC and up to 40GHz frequencies.

For more information or for configurations not listed here, we can provide solutions based on your requirements pending an MOQ, please contact your local customer services department to discuss further.



2. SMA Connectors & Adaptors

SMA Connectors - PCB Mount

SMA(F)ST for Circular PCB Edge Mount Gold Plating 0.94mm board

Part Number

EMPCB.CSMAFST.A.AU	VSWR	Frequency	Impedance
	≤ 2	0 - 18GHz	50 Ω

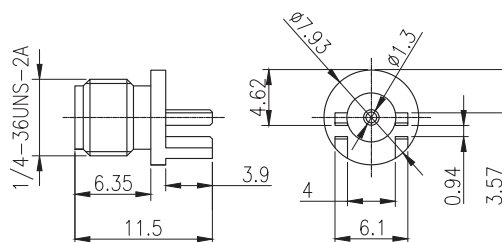

SMA(F)ST for Circular PCB Edge Mount Gold Plating

Part Number

EMPCB.CSMAFSTJ.A	VSWR	Frequency	Impedance
	≤ 2	0 - 18GHz	50 Ω

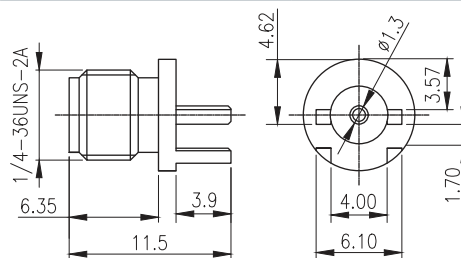

SMA(F)ST for PCB Edge Mount Nickel Plating

Part Number

EMPCB.CSMAFSTJ.NI	VSWR	Frequency	Impedance
	≤ 2	0 - 18GHz	50 Ω

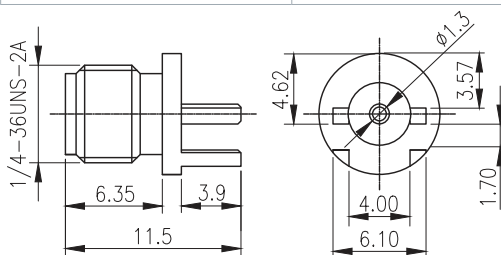

SMA(F)ST for PCB Edge Mount Nickel Plating Connector Solder Attachment

Part Number

EMPCB.SMAFSTJ.C.HT	VSWR	Frequency	Impedance
	≤ 2	0 - 18GHz	50 Ω

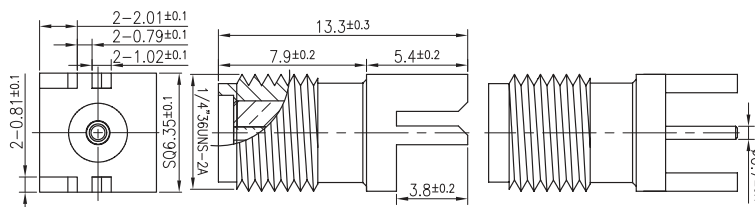

SMA(F)ST for PCB Edge Mount Gold Plating 11.4mm Thread

Part Number

EMPCB.SMAFSTJ.F.HT	VSWR	Frequency	Impedance
	≤ 2	0 - 18GHz	50 Ω

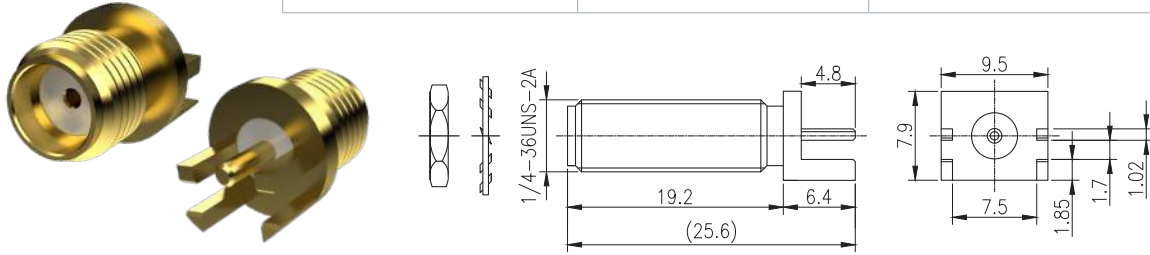

SMA(M)ST for PCB Edge Mount Gold Plating 0.94mm board

Part Number

EMPCB.SMAMST.A	VSWR	Frequency	Impedance
	≤ 2	0 - 18GHz	50 Ω

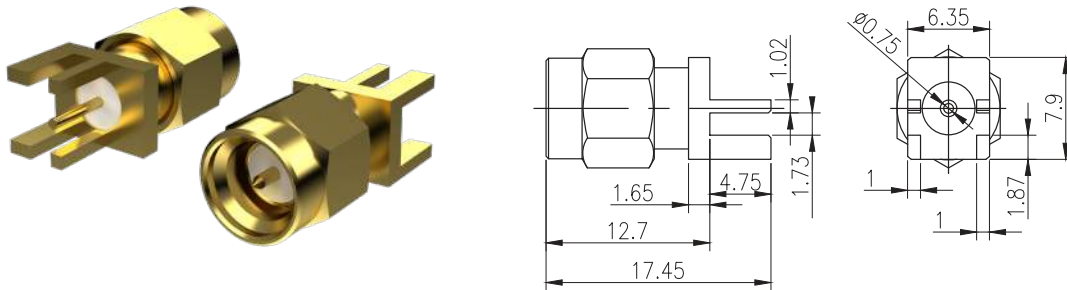

SMA(M)ST for PCB Edge Mount Nickel Plating 0.94mm board

Part Number

EMPCB.SMAMSTP.A.NI	VSWR	Frequency	Impedance
	≤ 2	0 - 18GHz	50 Ω

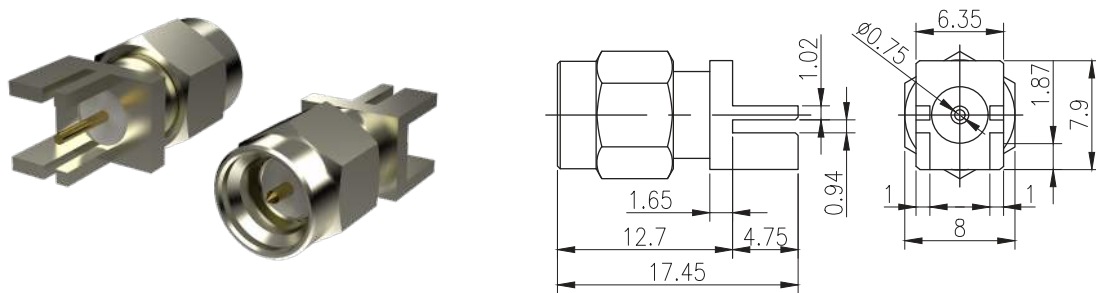

SMA(M)ST for PCB Edge Mount Nickel Plating 1.5mm board

Part Number

EMPCB.SMAMSTP.NI	VSWR	Frequency	Impedance
	≤ 2	0 - 18GHz	50 Ω

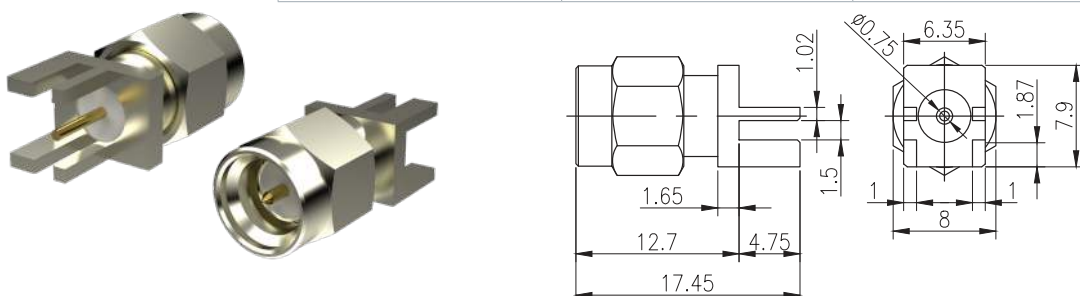

SMA Straight PCB Edge Mount/End Launch, Jack, Gold, 50Ω, Connector Solder Attachment

Part Number

EMPCB.SMAFSTJ.B.HT	VSWR	Frequency	Impedance
	≤ 2	0 - 18GHz	50Ω

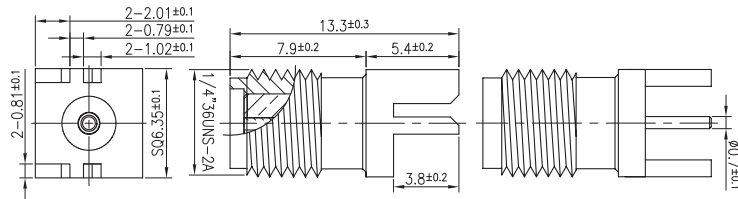

SMA(F)RA for PCB Mount Nickel Plating Leg Length: 3.9mm Extended Thread 11.4mm

Part Number

PCB.114SMAFRA.NI	VSWR	Frequency	Impedance
	≤ 2	0 - 18GHz	50Ω

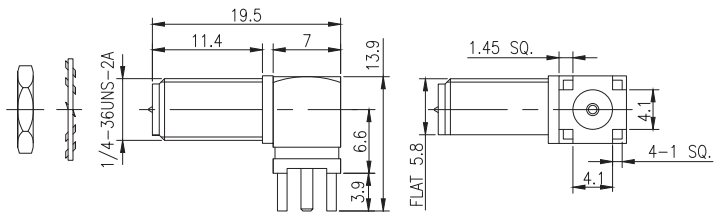
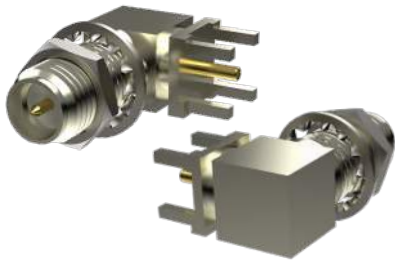

SMA(F)RA for PCB Mount Gold Plating 11.4mm Thread

Part Number

PCB.114SMAFRA.YC	VSWR	Frequency	Impedance
	≤ 2	0 - 18GHz	50Ω

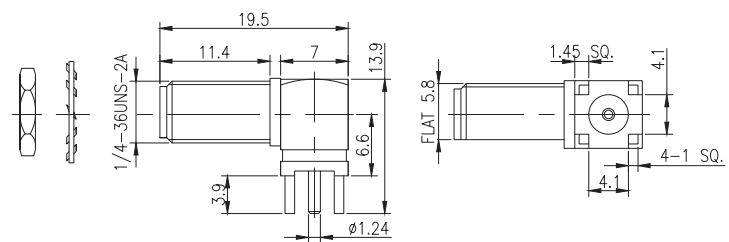
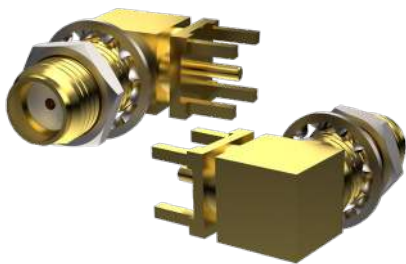

SMA(F)RA for PCB Mount Gold Plating SMD 11.4mm Thread

Part Number

PCB.114SMAFRAJ.A	VSWR	Frequency	Impedance
	≤ 2	0 - 18GHz	50Ω

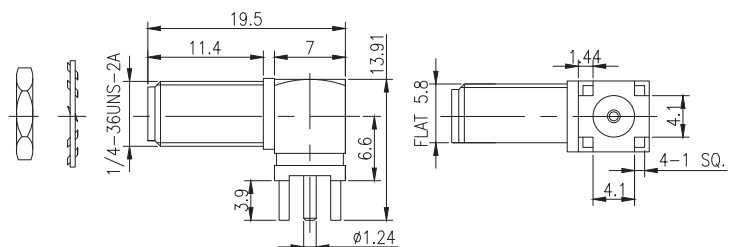
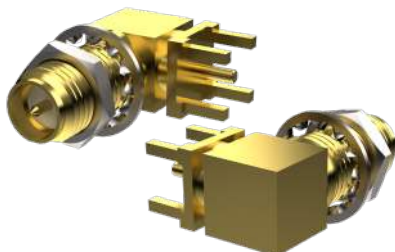

SMA(F)RA RP for PCB Mount Gold Plating SMD 11.4mm Thread 3.9mm Leg Length

Part Number

PCB.114SMAFRPRAJ.A	VSWR	Frequency	Impedance
	≤ 2	0 - 18GHz	50 Ω

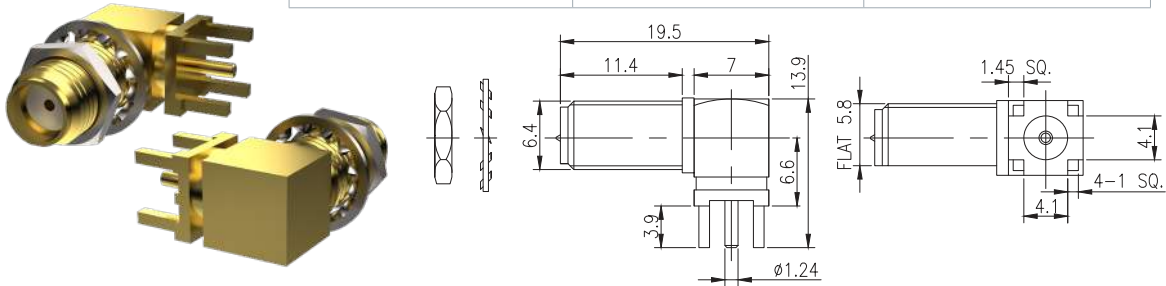

SMA(F)ST for PCB Mount Gold Plating SMD 11.4mm Thread

Part Number

PCB.114SMAFSTJ.A	VSWR	Frequency	Impedance
	≤ 2	0 - 18GHz	50 Ω

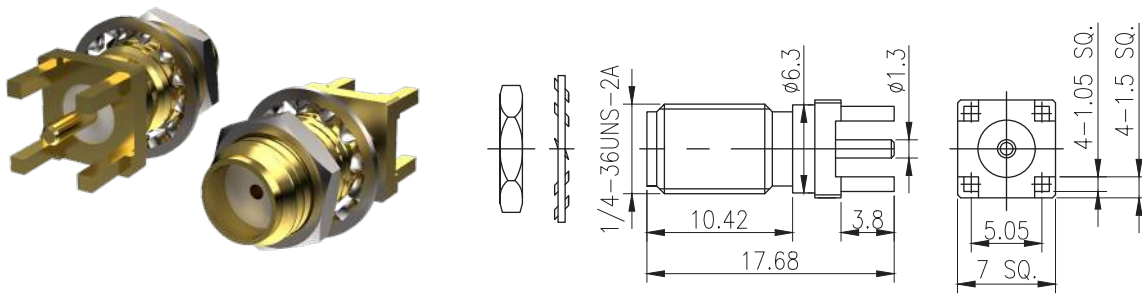

SMA(F)ST for Circular PCB Mount Gold Plating

Part Number

PCB.CSMAFSTJ.A	VSWR	Frequency	Impedance
	≤ 2	0 - 18GHz	50 Ω

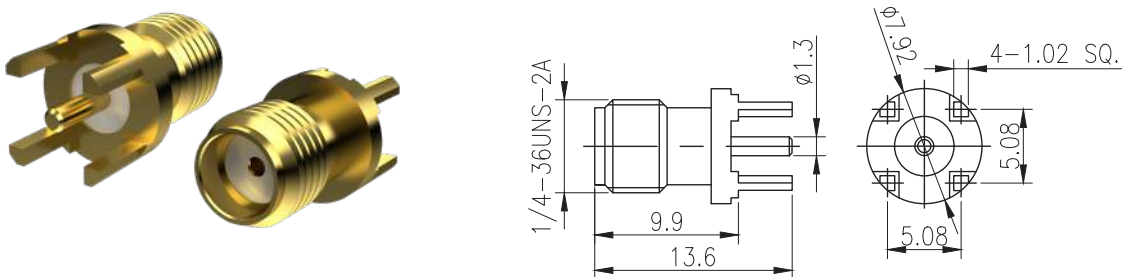

SMA(F)ST for Circular PCB Mount Nickel Plating

Part Number

PCB.CSMAFSTJ.A.NI	VSWR	Frequency	Impedance
	≤ 2	0 - 18GHz	50 Ω

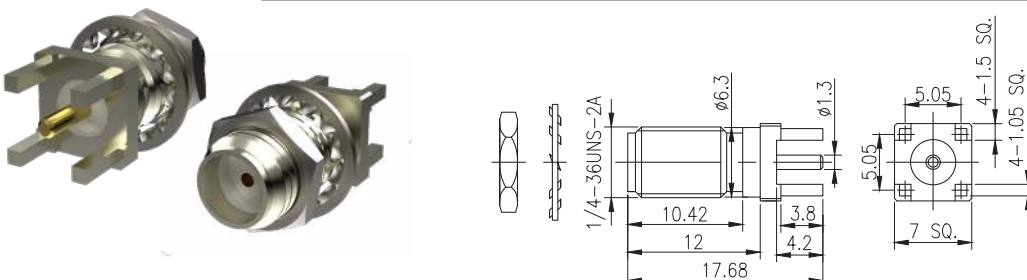

SMA(F)RA for PCB Mount Nickel Plating Through Hole Pin

Part Number

PCB.SMAFRA.NI	VSWR	Frequency	Impedance
	≤ 2	0 - 18GHz	50 Ω

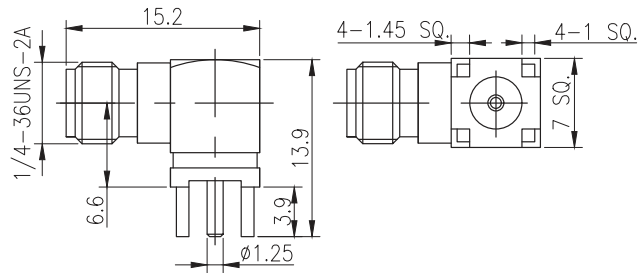
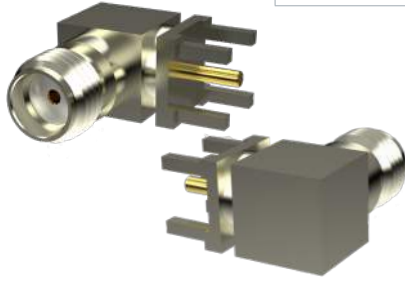

RP-SMA(F)RA for PCB Mount Nickel Plating Through Hole Pin

Part Number

PCB.SMAFRPRA.NI	VSWR	Frequency	Impedance
	≤ 2	0 - 18GHz	50 Ω

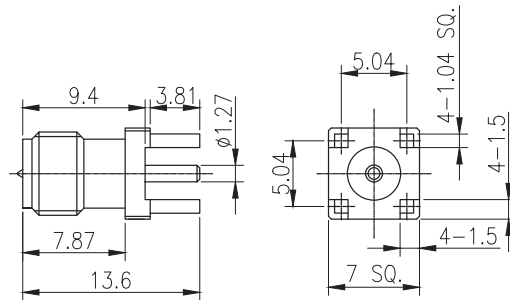

SMA(F)ST RP for PCB Mount Gold Plating

Part Number

PCB.SMAFRPST.HT	VSWR	Frequency	Impedance
	≤ 2	0 - 18GHz	50 Ω

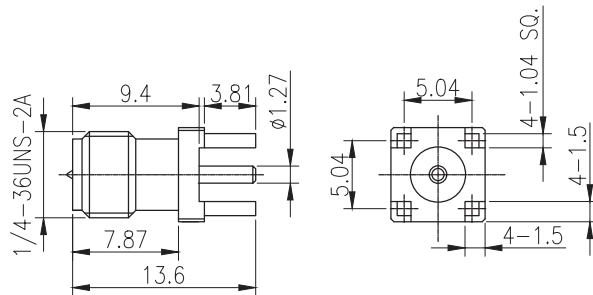

SMA(F)ST for PCB Mount Nickel Plating

Part Number

PCB.SMAFSTJ.NI	VSWR	Frequency	Impedance
	≤ 2	0 - 18GHz	50 Ω

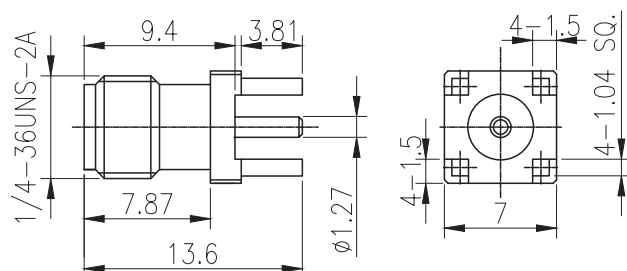

SMA Straight PCB Mount, Jack, Gold, 50Ω, Surface Mount 1MM Leg Length

Part Number

PCB.SMAFSTJ.B.HT	VSWR	Frequency	Impedance
	≤ 2	0 - 18GHz	50Ω

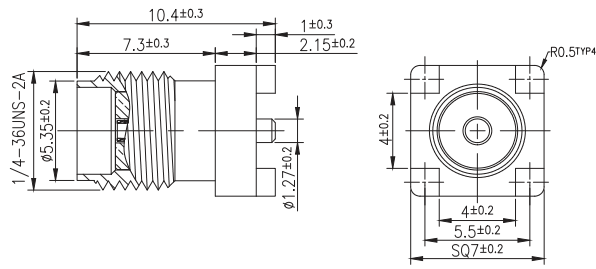

SMA Straight PCB Mount, Jack, Gold, 50Ω, Through Hole Pin

Part Number

PCB.SMAFSTJ.A.HT	VSWR	Frequency	Impedance
	≤ 2	0 - 18GHz	50Ω

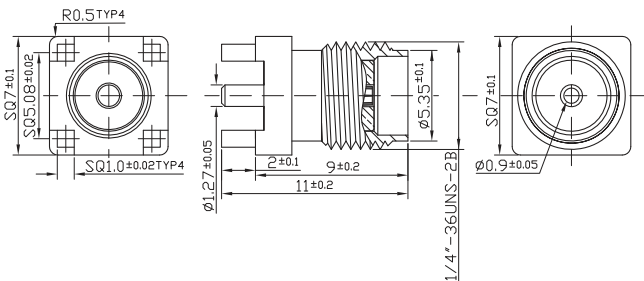

SMA Straight Panel Mount, Jack, Nickel, 50Ω, 2 Mounting Holes, Solder Termination Coaxial

Part Number

PCB.SMAFST.2H.B.HT	VSWR	Frequency	Impedance
	≤ 2	0 - 18GHz	50Ω

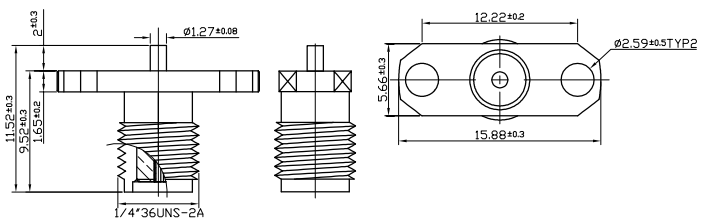

SMA Straight Panel Mount, Jack, Gold, 50Ω, 2 Mounting Holes, Solder Termination Coaxial

Part Number

PCB.SMAFST.2H.A.HT	VSWR	Frequency	Impedance
	≤ 2	0 - 18GHz	50Ω

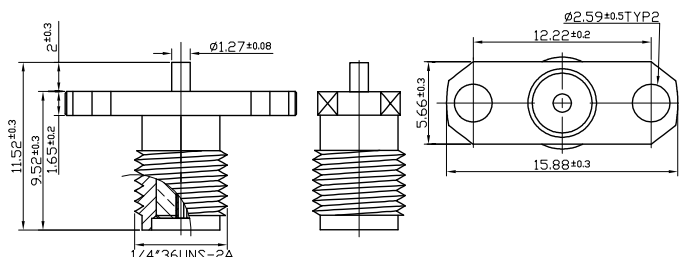

SMA RA PCB Mount, Jack, Gold, 50Ω, Through Hole Pin

Part Number

PCB.SMAFRA.HT	VSWR	Frequency	Impedance
	≤ 2	0 - 18GHz	50Ω

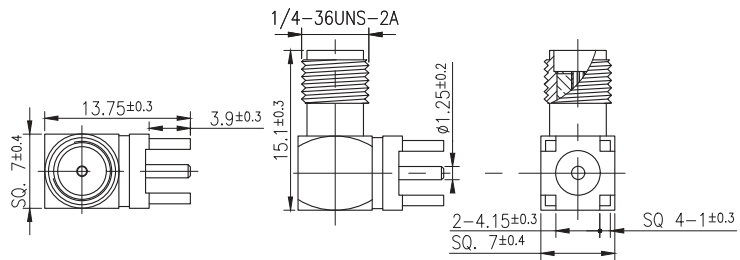

SMA RA Reverse Polarity PCB Mount, Jack, Gold, 50Ω, Through Hole Pin

Part Number

PCB.RPSMAFRA.HT	VSWR	Frequency	Impedance
	≤ 2	0 - 18GHz	50Ω

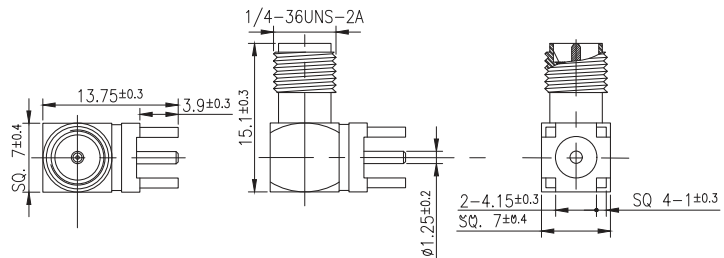

SMA Connectors - Cable Mount

SMA(M)ST RP for RG-176/RG-316 Nickel Plating

Part Number

SMAFRPST.J.DK.HT	VSWR	Frequency	Impedance
	≤ 1.20	40GHz	50Ω

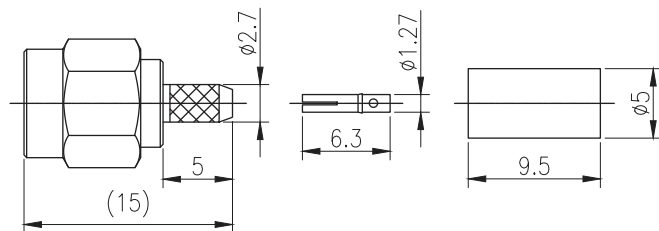

SMA(M)ST RP for RG-58/LMR-195/CFD-200 Nickel Plating

Part Number

SMAFRPST.J.GN.HT	VSWR	Frequency	Impedance
	≤ 2	0 - 18GHz	50Ω

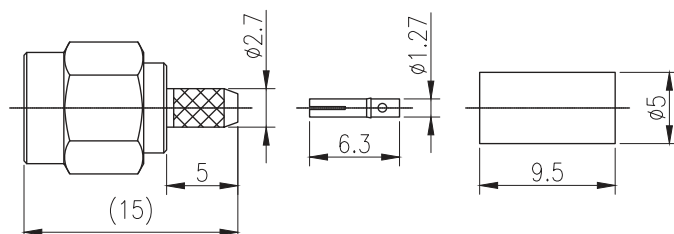

SMA(F)ST for RG-174/RG-316 Gold Plating

Part Number

SMAFST.J.DK.HT	VSWR	Frequency	Impedance
	≤ 2	0 - 18GHz	50 Ω

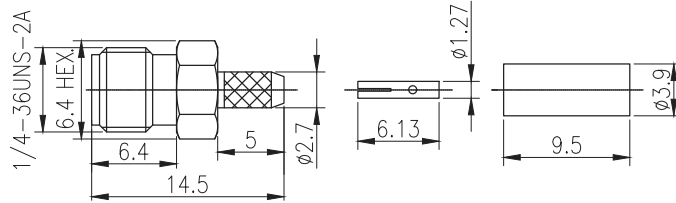

SMA(F)ST for RG--58/TGC-200/CFD-200 Nickel Plating

Part Number

SMAFSTNI.J.G.XX	VSWR	Frequency	Impedance
	≤ 2	0 - 18GHz	50 Ω

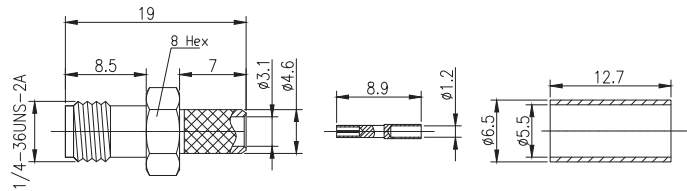

SMA(M)RA for RG-174/RG-316 Nickel Plating

Part Number

SMAMRA.P.DK.HT	VSWR	Frequency	Impedance
	≤ 2	0 - 18GHz	50 Ω

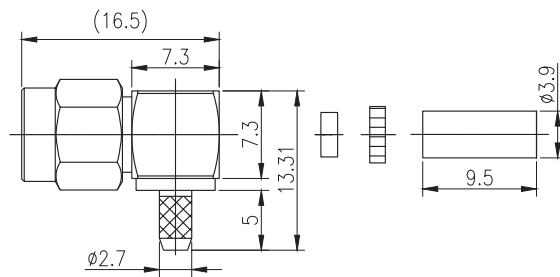
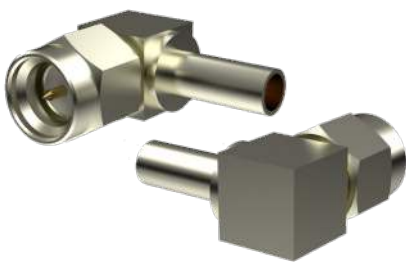

SMA(M)RA for RG-58/CFD-200 Nickel Plating

Part Number

SMAMRA.P.GN.HT	VSWR	Frequency	Impedance
	≤ 2	0 - 18GHz	50 Ω

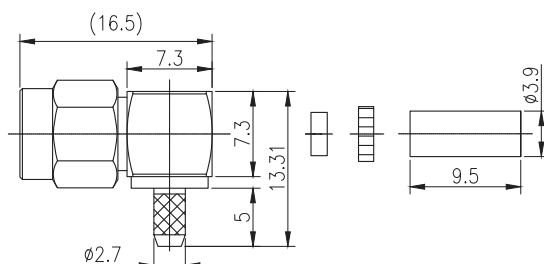
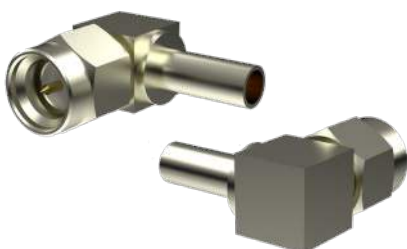

SMA(M)ST RP for RG-174/RG-316 Gold Plating

Part Number

SMAMPST.P.DK.XX	VSWR	Frequency	Impedance
	≤ 2	0 - 18GHz	50 Ω

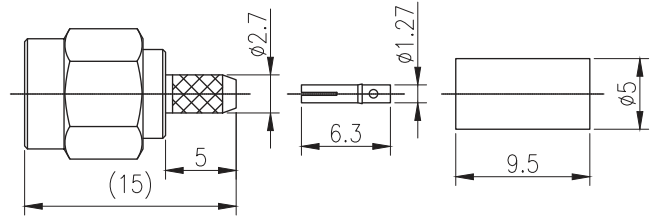

SMA(M)ST for RG-174 Gold Plating

Part Number

SMAMST.P.D.XX	VSWR	Frequency	Impedance
	≤ 2	0 - 18GHz	50 Ω

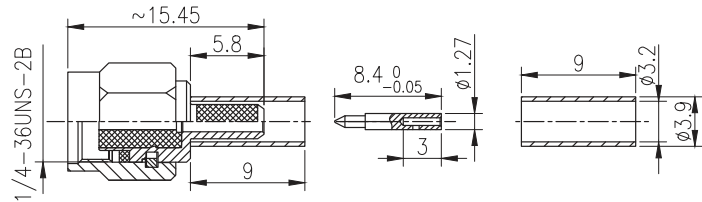

SMA(M)ST for RG-178 Gold Plating

Part Number

SMAMST.P.E.XX	VSWR	Frequency	Impedance
	≤ 2	0 - 18GHz	50 Ω

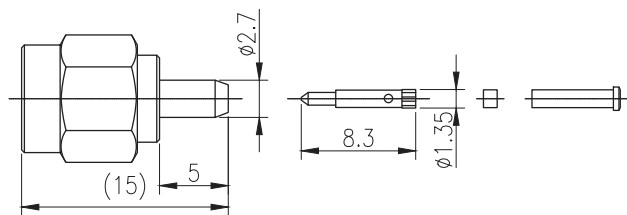

SMA(M)ST for RG-174 Nickel Plating

Part Number

SMAMST.P.NI.D.WY	VSWR	Frequency	Impedance
	≤ 2	0 - 18GHz	50 Ω

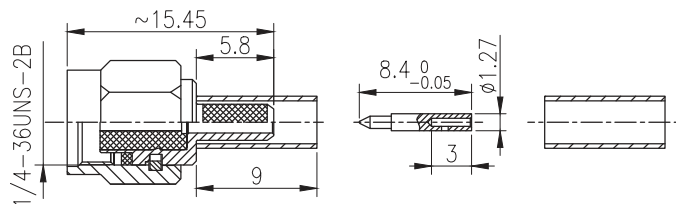

SMA(M)ST for 200 Series cable Nickel Plating

Part Number

SMAMST.P.NI.G.XX	VSWR	Frequency	Impedance
	≤ 2	0 - 18GHz	50 Ω

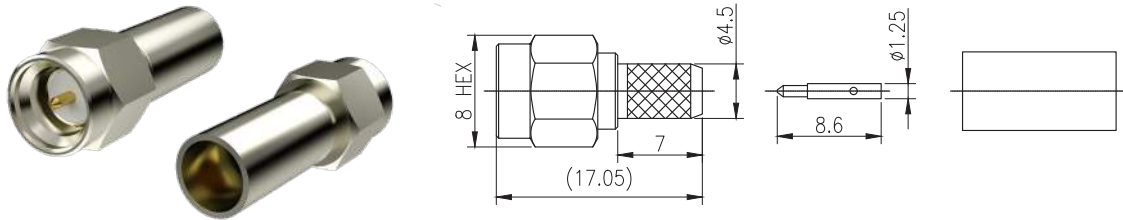

SMA Adapters

SMA(F)ST to SMA(M)RA Adapter

Part Number

SMAFST.SMAMRA.CO	VSWR	Frequency	Impedance
	≤ 1.20	40GHz	50 Ω

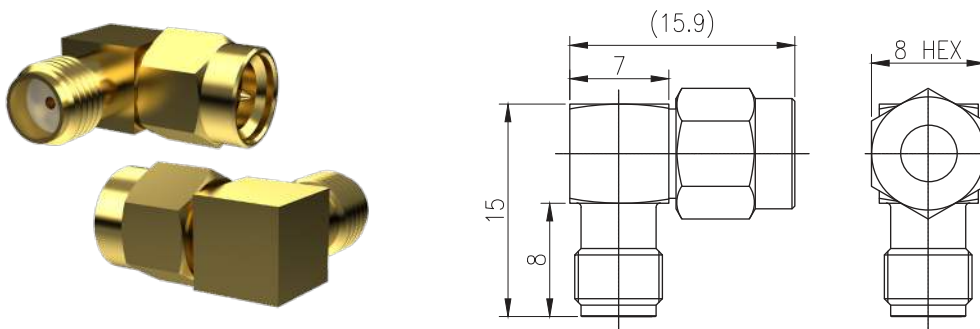

3. NMO Connectors

NMO Connectors - Cable Mount

High Performance Direct Mount NMO Connector

Part Number

NMODM.34.N.YN*	VSWR	Frequency	Impedance
	≤ 2	0 - 6GHz	50 Ω

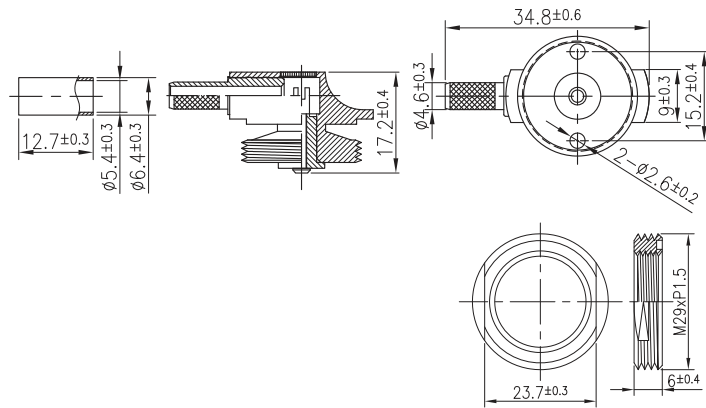

4. MCX Connectors

MCX Connectors - PCB Mount

MCX(F)RA for PCB Mount Gold Plating Leg length 4.4mm

Part Number

PCB.MCXFRAJ.A	VSWR	Frequency	Impedance
	≤ 2	0 - 6GHz	50 Ω

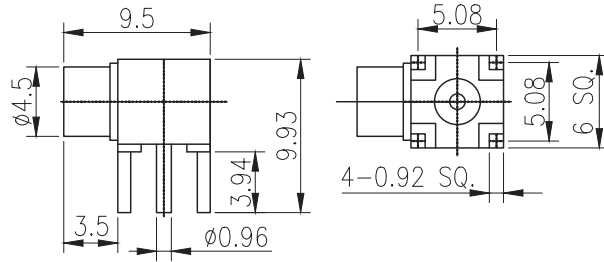
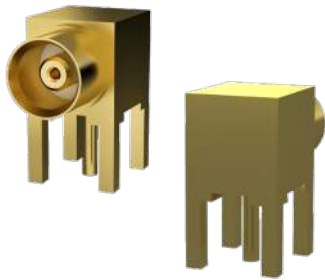

MCX(F)ST for PCB Mount Gold Plating Leg length 3.9mm

Part Number

PCB.MCXFSTJ.A	VSWR	Frequency	Impedance
	≤ 2	0 - 6GHz	50 Ω

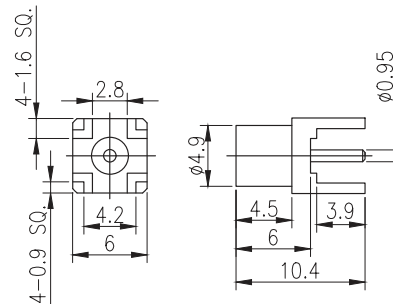

5. MMCX Connectors

MMCX Connectors - Cable Mount

MMCX(M)RA for RG-174/RG-316 Gold Plating

Part Number

MMCXMRA.P.DK.HT	VSWR	Frequency	Impedance
	≤ 2	0 - 6GHz	50 Ω

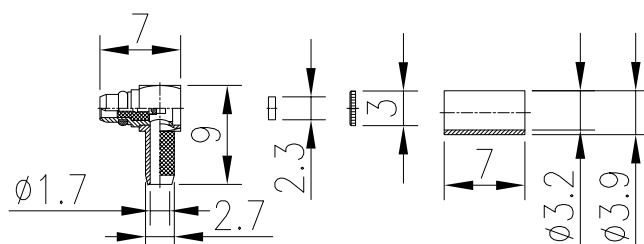
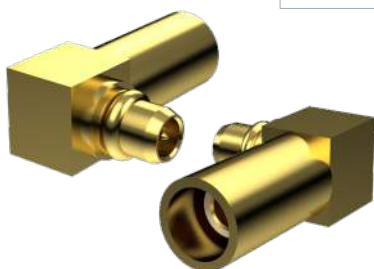

MMCX(M)ST for RG-174/RG-316 Gold Plating

Part Number

MMCXMST.DK.J	VSWR	Frequency	Impedance
	≤ 2	0 - 6GHz	50 Ω

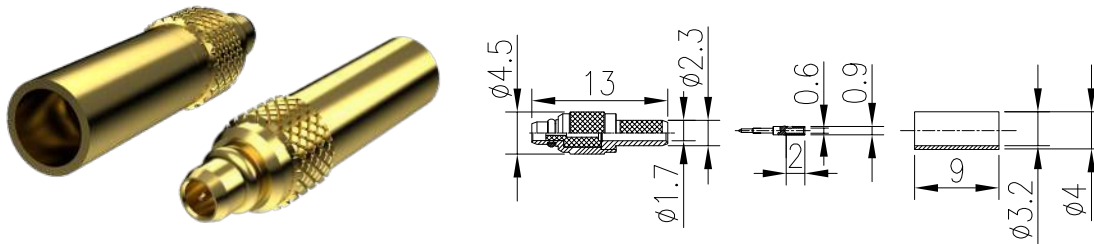

MMCX Connectors - PCB Mount

MMCX Straight PCB Mount, Jack, Gold, 50 Ω , Surface Mount

Part Number

PCB.MMCXFSTJ.SMT.HT	VSWR	Frequency	Impedance
	≤ 2	0 - 6GHz	50 Ω

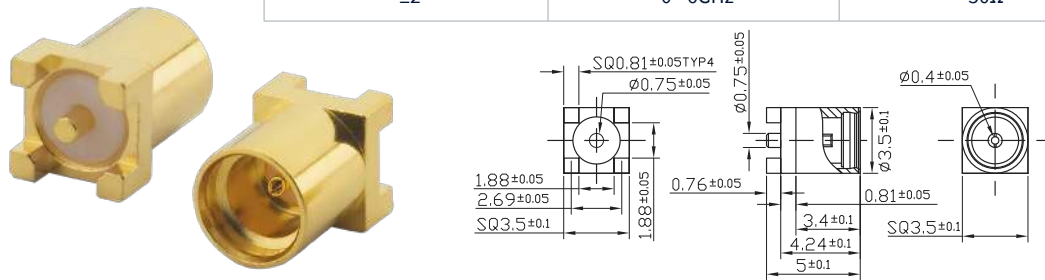

MMCX Straight PCB Mount, Jack, Gold, 50 Ω , Through Hole Pin

Part Number

PCB.MMCXFSTJ.HT	VSWR	Frequency	Impedance
	≤ 2	0 - 6GHz	50 Ω

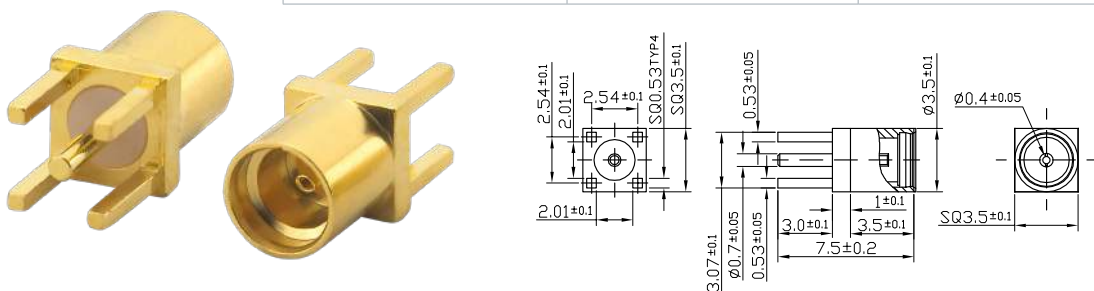

MMCX(F)RA for PCB Mount Gold Plating Leg length 0.7mm

Part Number

PCB.MMCXFRAJ.A	VSWR	Frequency	Impedance
	≤ 2	0 - 6GHz	50 Ω

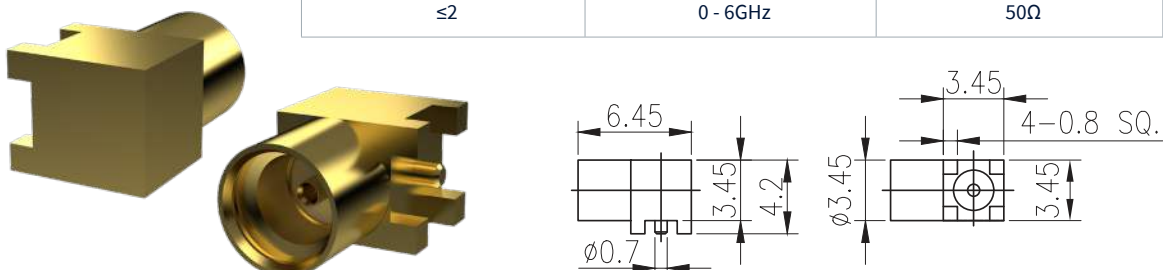

MMCX(F)RA for PCB Mount Gold Plating Total Length 6.9mm

Part Number

PCB.MMCXFRAJ.A.J	VSWR	Frequency	Impedance
	≤ 2	0 - 6GHz	50 Ω

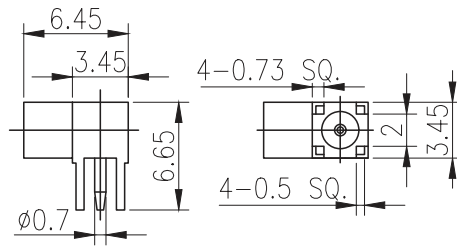
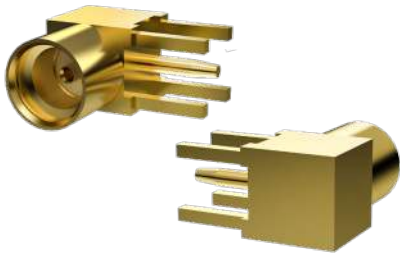

MMCX(F)ST for SMT Gold Plating Short Legs 0.7mm

Part Number

PCB.MMCXFSTJ.C.A	VSWR	Frequency	Impedance
	≤ 2	0 - 6GHz	50 Ω

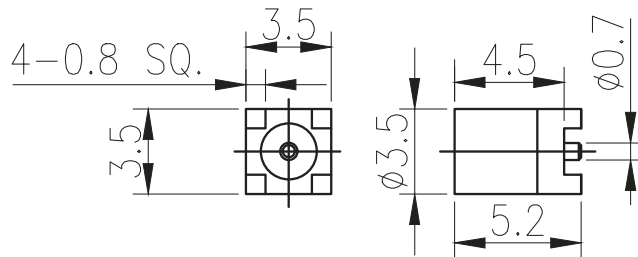

MMCX Straight PCB Edge Mount/End Launch, Jack, Gold, 50 Ω , Connector Solder Attachment

Part Number

EMPCB.MMCXFSTJ.A.HT	VSWR	Frequency	Impedance
	≤ 2	0 - 6GHz	50 Ω

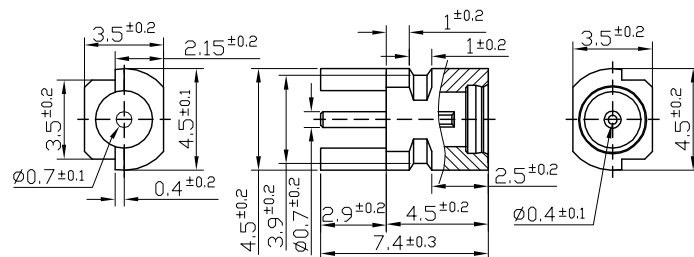

6. FAKRA Connectors

FAKRA Connectors - Cable Mount

FAKRA Generation 3 Code D Claret/Violet Plug Connector for RG--174 & RG--316 Type Cables

Part Number

FK.G3.SMBFST.D.AP	VSWR	Frequency	Impedance
	≤2	0 - 6GHz	50Ω

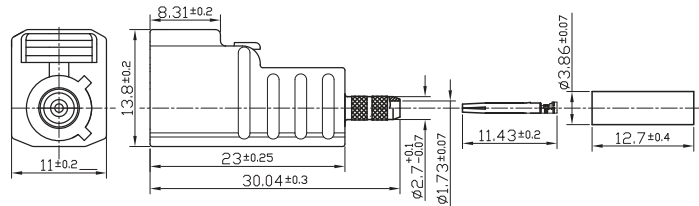

FAKRA Generation 1 Code A Black Female Jack for RG-174/RG-316/TGC-1.5DS

Part Number

FK1FADK	VSWR	Frequency	Impedance
	0 ~ 3000MHz < 1.3 3000 ~ 6000MHz < 1.5	DC - 6000MHz	50Ω Nominal

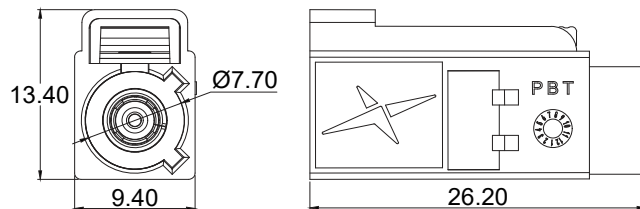

FAKRA Generation 1 Code A Black Male Plug for RG-174/RG-316/TGC-1.5DS

Part Number

FK0MADK	VSWR	Frequency	Impedance
	0 ~ 3000MHz < 1.3 3000 ~ 6000MHz < 1.5	DC - 6000MHz	50Ω Nominal

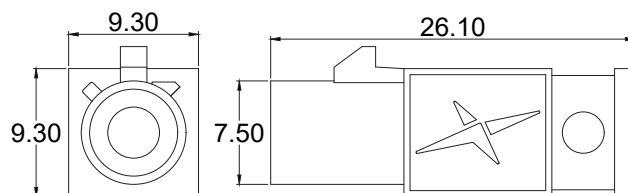

FAKRA Generation 1 Code C Blue Female Jack for RG-174/RG-316/TGC-1.5DS

Part Number

FK1FCDK	VSWR	Frequency	Impedance
	0 ~ 3000MHz < 1.3 3000 ~ 6000MHz < 1.5	DC - 6000MHz	50Ω Nominal

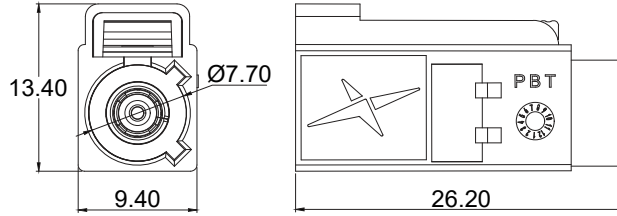

FAKRA Generation 1 Code C Blue Male Plug for RG-174/RG-316/TGC-1.5DS

Part Number

FK0MCDK	VSWR	Frequency	Impedance
	0 ~ 3000MHz < 1.3 3000 ~ 6000MHz < 1.5	DC - 6000MHz	50Ω Nominal

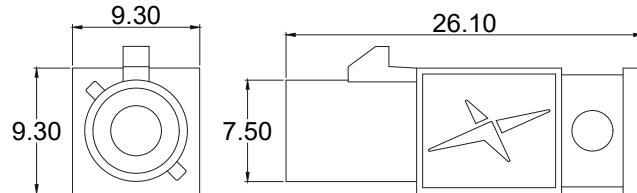

FAKRA Generation 1 Code C Blue Female Jack for CFD-200 / TGC-200

Part Number

FK1FCG	VSWR	Frequency	Impedance
	0 ~ 3000MHz < 1.3 3000 ~ 6000MHz < 1.5	DC - 6000MHz	50Ω Nominal

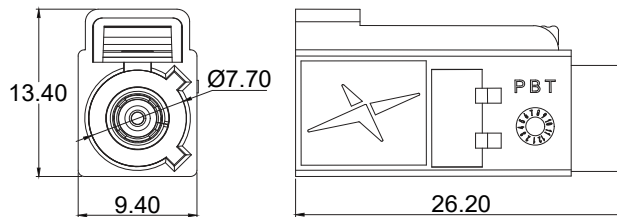

FAKRA Generation 1 Code C Blue Male Plug for CFD-200 / TGC-200

Part Number

FK0MCG	VSWR	Frequency	Impedance
	0 ~ 3000MHz < 1.3 3000 ~ 6000MHz < 1.5	DC - 6000MHz	50Ω Nominal

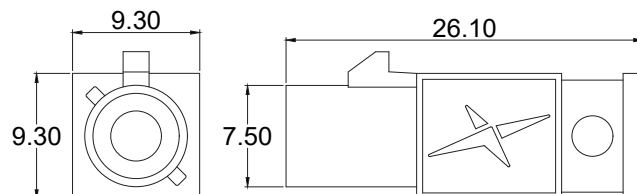

FAKRA Generation 1 Code D Bordeaux Violet Female Jack for RG-174/RG-316/TGC-1.5DS

Part Number

FK1FDDK	VSWR	Frequency	Impedance
	0 ~ 3000MHz < 1.3 3000 ~ 6000MHz < 1.5	DC - 6000MHz	50Ω Nominal

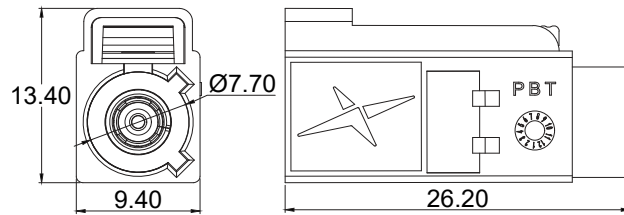

FAKRA Generation 1 Code D Bordeaux Violet Male Plug for RG-174/RG-316/TGC-1.5DS

Part Number

FK0MDDK	VSWR	Frequency	Impedance
	0 ~ 3000MHz < 1.3 3000 ~ 6000MHz < 1.5	DC - 6000MHz	50Ω Nominal

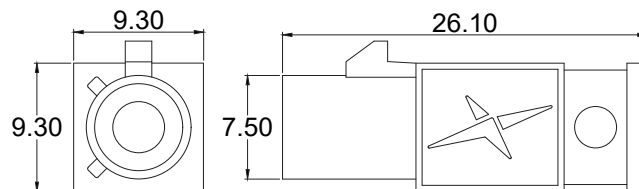

FAKRA Generation 1 Code D Bordeaux Violet Female Jack for CFD200

Part Number

FK1FDG	VSWR	Frequency	Impedance
	0 ~ 3000MHz < 1.3 3000 ~ 6000MHz < 1.5	DC - 6000MHz	50Ω Nominal

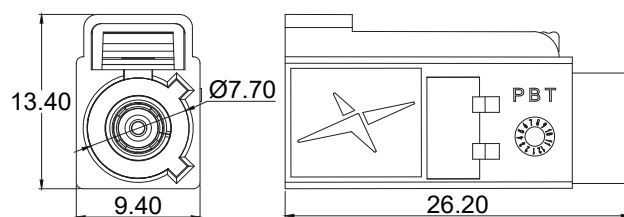

FAKRA Generation 1 Code D Bordeaux Violet Male Plug for CFD200

Part Number

FK0MDG	VSWR	Frequency	Impedance
	0 ~ 3000MHz < 1.3 3000 ~ 6000MHz < 1.5	DC - 6000MHz	50Ω Nominal

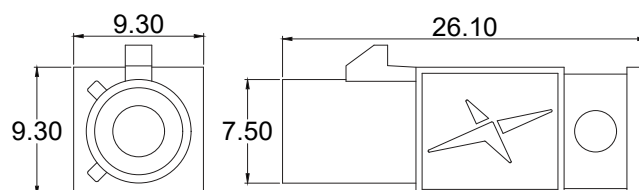

FAKRA Generation 1 Code I Beige Female Jack for RG-174/RG-316/TGC-1.5DS

Part Number

FK1FIDK	VSWR	Frequency	Impedance
	0 ~ 3000MHz < 1.3 3000 ~ 6000MHz < 1.5	DC - 6000MHz	50Ω Nominal

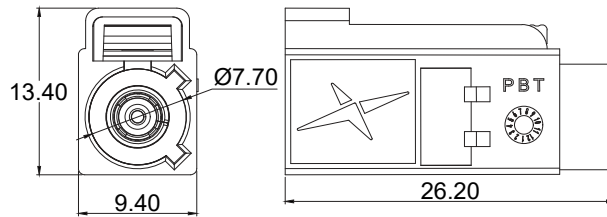

FAKRA Generation 1 Code I Beige Male Plug for RG-174/RG-316/TGC-1.5DS

Part Number

FK0MIDK	VSWR	Frequency	Impedance
	0 ~ 3000MHz < 1.3 3000 ~ 6000MHz < 1.5	DC - 6000MHz	50Ω Nominal

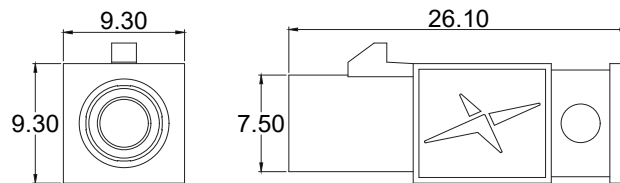

FAKRA Generation 1 Code I Beige Female Jack for CFD-200 / TGC-200

Part Number

FK1FIG	VSWR	Frequency	Impedance
	0 ~ 3000MHz < 1.3 3000 ~ 6000MHz < 1.5	DC - 6000MHz	50Ω Nominal

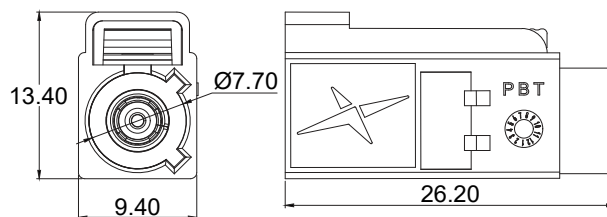

FAKRA Generation 1 Code I Beige Male Plug for CFD-200 / TGC-200

Part Number

FK0MIG	VSWR	Frequency	Impedance
	0 ~ 3000MHz < 1.3 3000 ~ 6000MHz < 1.5	DC - 6000MHz	50Ω Nominal

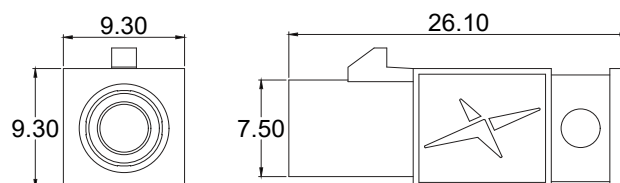

FAKRA Generation 1 Code K Curry Yellow Female Jack for RG-174/RG-316/TGC-1.5DS

Part Number

FK1FKDK	VSWR	Frequency	Impedance
	0 ~ 3000MHz < 1.3 3000 ~ 6000MHz < 1.5	DC - 6000MHz	50Ω Nominal

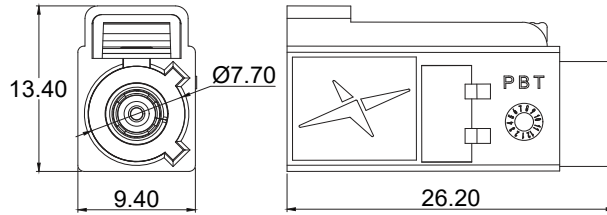

FAKRA Generation 1 Code K Curry Yellow Male Plug for RG-174/RG-316/TGC-1.5DS

Part Number

FK0MKDK	VSWR	Frequency	Impedance
	0 ~ 3000MHz < 1.3 3000 ~ 6000MHz < 1.5	DC - 6000MHz	50Ω Nominal

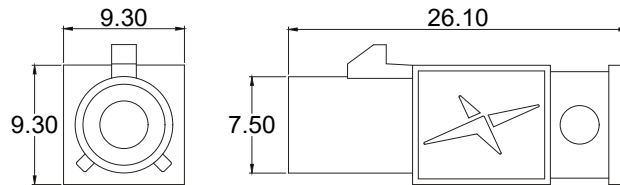

FAKRA Generation 1 Code K Curry Yellow Female Jack for CFD-200 / TGC-200

Part Number

FK1FKG	VSWR	Frequency	Impedance
	0 ~ 3000MHz < 1.3 3000 ~ 6000MHz < 1.5	DC - 6000MHz	50Ω Nominal

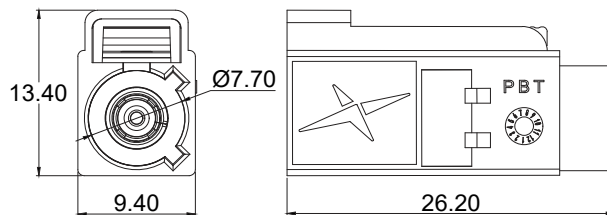

FAKRA Generation 1 Code K Curry Yellow Male Plug for CFD-200 / TGC-200

Part Number

FK0MKG	VSWR	Frequency	Impedance
	0 ~ 3000MHz < 1.3 3000 ~ 6000MHz < 1.5	DC - 6000MHz	50Ω Nominal

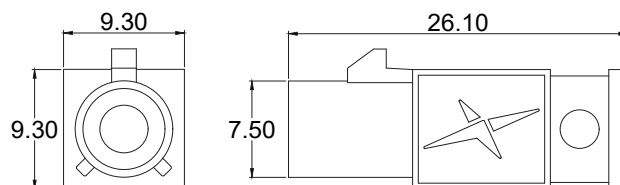

FAKRA Generation 1 Code L Carmine Red Female Jack for RG-174/RG-316/TGC-1.5DS

Part Number

FK1FLDK	VSWR	Frequency	Impedance
	0 ~ 3000MHz < 1.3 3000 ~ 6000MHz < 1.5	DC - 6000MHz	50Ω Nominal

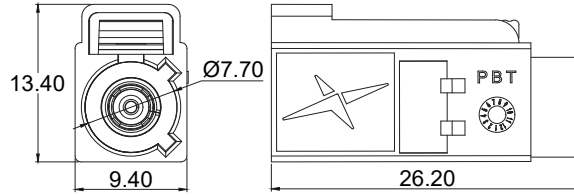

FAKRA Generation 1 Code L Carmine Red Male Plug for RG-174/RG-316/TGC-1.5DS

Part Number

FK0MLDK	VSWR	Frequency	Impedance
	0 ~ 3000MHz < 1.3 3000 ~ 6000MHz < 1.5	DC - 6000MHz	50Ω Nominal

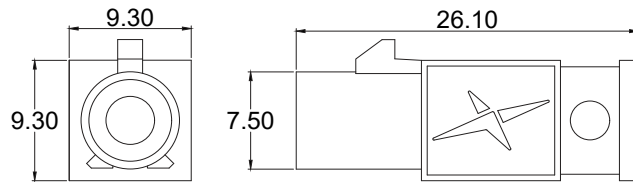

FAKRA Generation 1 Code L Carmine Red Female Jack for CFD-200 / TGC-200

Part Number

FK1FLG	VSWR	Frequency	Impedance
	0 ~ 3000MHz < 1.3 3000 ~ 6000MHz < 1.5	DC - 6000MHz	50Ω Nominal

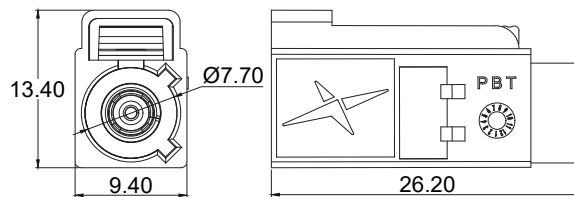

FAKRA Generation 1 Code L Carmine Red Male Plug for CFD-200 / TGC-200

Part Number

FK0MLG	VSWR	Frequency	Impedance
	0 ~ 3000MHz < 1.3 3000 ~ 6000MHz < 1.5	DC - 6000MHz	50Ω Nominal

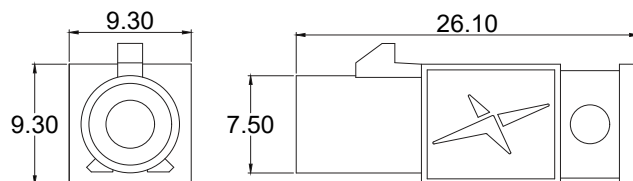

FAKRA Generation 1 Code Z Water Blue Female Jack for RG-174/RG-316/TGC-1.5DS

Part Number

FK1FZDK	VSWR	Frequency	Impedance
	0 ~ 3000MHz < 1.3 3000 ~ 6000MHz < 1.5	DC - 6000MHz	50Ω Nominal

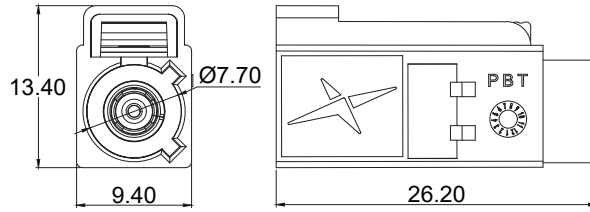

FAKRA Generation 1 Code Z Water Blue Male Plug for RG-174/RG-316/TGC-1.5DS

Part Number

FK0MZDK	VSWR	Frequency	Impedance
	0 ~ 3000MHz < 1.3 3000 ~ 6000MHz < 1.5	DC - 6000MHz	50Ω Nominal

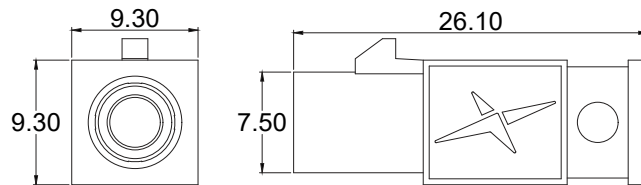

FAKRA Generation 1 Code Z Water Blue Female Jack for CFD-200 / TGC-200

Part Number

FK1FZG	VSWR	Frequency	Impedance
	0 ~ 3000MHz < 1.3 3000 ~ 6000MHz < 1.5	DC - 6000MHz	50Ω Nominal

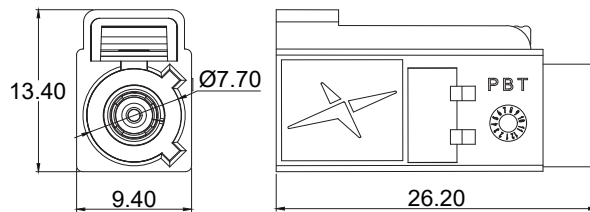

FAKRA Generation 1 Code Z Water Blue Male Plug for CFD-200 / TGC-200

Part Number

FK0MZG	VSWR	Frequency	Impedance
	0 ~ 3000MHz < 1.3 3000 ~ 6000MHz < 1.5	DC - 6000MHz	50Ω Nominal

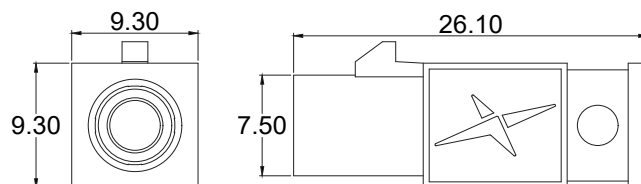

Dual FAKRA Code D Bordeaux Violet Female Jack for RG-174/RG-316/TGC-1.5DS

Part Number

FKDFDDK	VSWR	Frequency	Impedance
	0 ~ 3000MHz < 1.3 3000 ~ 6000MHz < 1.5	DC - 6000MHz	50Ω Nominal

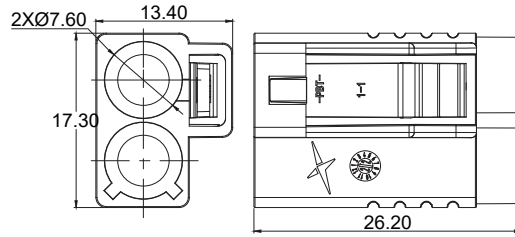

Dual FAKRA Code D Bordeaux Violet Male Plug for RG-174/RG-316/TGC-1.5DS

Part Number

FKDMDDK	VSWR	Frequency	Impedance
	0 ~ 3000MHz < 1.3 3000 ~ 6000MHz < 1.5	DC - 6000MHz	50Ω Nominal

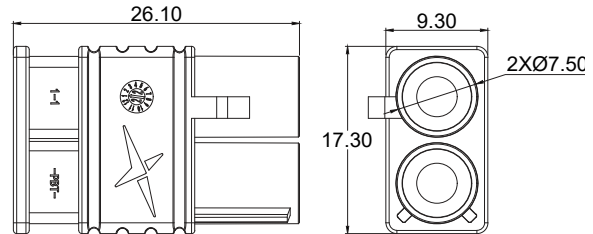

Dual FAKRA Code D Bordeaux Violet Female Jack for TGC/CFD200

Part Number

FKDFDG	VSWR	Frequency	Impedance
	0 ~ 3000MHz < 1.3 3000 ~ 6000MHz < 1.5	DC - 6000MHz	50Ω Nominal

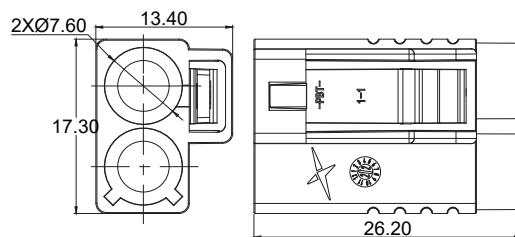

Dual FAKRA Code D Bordeaux Violet Male Plug for TGC/CFD200

Part Number

FKDMDG	VSWR	Frequency	Impedance
	0 ~ 3000MHz < 1.3 3000 ~ 6000MHz < 1.5	DC - 6000MHz	50Ω Nominal

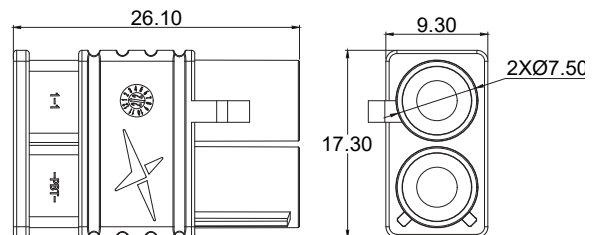

Dual FAKRA Code I Beige Female Jack for CFD-200/TGC-200

Part Number

FKDFIDK	VSWR	Frequency	Impedance
	0 ~ 3000MHz < 1.3 3000 ~ 6000MHz < 1.5	DC - 6000MHz	50Ω Nominal

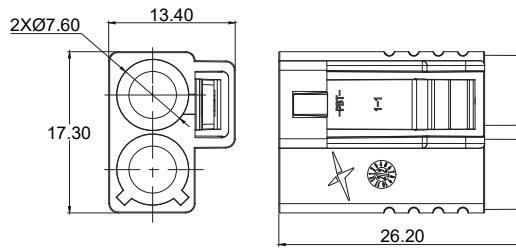

Dual FAKRA Code I Beige Male Plug for CFD-200/TGC-200

Part Number

FKDMIDK	VSWR	Frequency	Impedance
	0 ~ 3000MHz < 1.3 3000 ~ 6000MHz < 1.5	DC - 6000MHz	50Ω Nominal

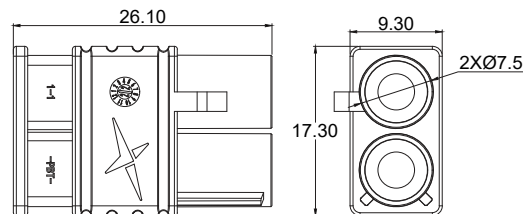

Dual FAKRA Code I Beige Female Jack for CFD-200/TGC-200

Part Number

FKDFIG	VSWR	Frequency	Impedance
	0 ~ 3000MHz < 1.3 3000 ~ 6000MHz < 1.5	DC - 6000MHz	50Ω Nominal

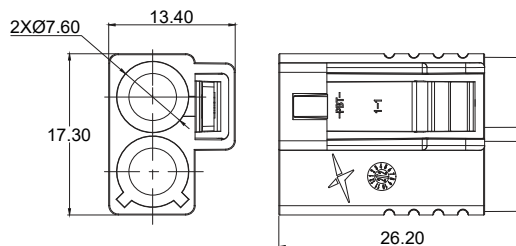

Dual FAKRA Code I Beige Male Plug for CFD-200/TGC-200

Part Number

FKDMIG	VSWR	Frequency	Impedance
	0 ~ 3000MHz < 1.3 3000 ~ 6000MHz < 1.5	DC - 6000MHz	50Ω Nominal

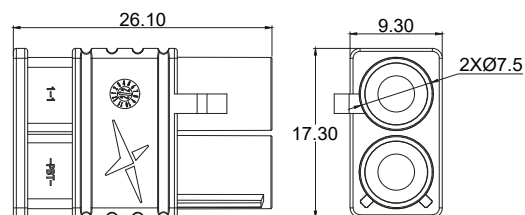

Dual FAKRA Code Z Water Blue Female Jack for RG-174/RG-316/TGC-1.5DS

Part Number

FKDFZDK	VSWR	Frequency	Impedance
	0 ~ 3000MHz < 1.3 3000 ~ 6000MHz < 1.5	DC - 6000MHz	50Ω Nominal

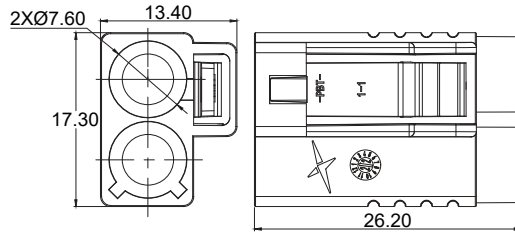

Dual FAKRA Code Z Water Blue Male Plug for RG-174/RG-316/TGC-1.5DS

Part Number

FKDMZDK	VSWR	Frequency	Impedance
	0 ~ 3000MHz < 1.3 3000 ~ 6000MHz < 1.5	0 ~ 9000MHz	50Ω Nominal

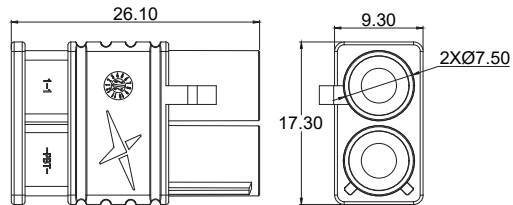

Dual FAKRA Code Z Water Blue Female Jack for CFD-200/TGC-200

Part Number

FKDFZG	VSWR	Frequency	Impedance
	0 ~ 3000MHz < 1.3 3000 ~ 6000MHz < 1.5	DC - 6000MHz	50Ω Nominal

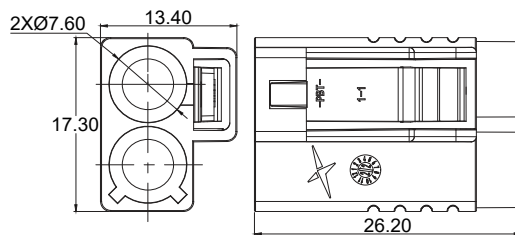

Dual FAKRA Code Z Water Blue Male Plug for CFD-200/TGC-200

Part Number

FKDMZG	VSWR	Frequency	Impedance
	0 ~ 3000MHz < 1.3 3000 ~ 6000MHz < 1.5	0 ~ 9000MHz	50Ω Nominal

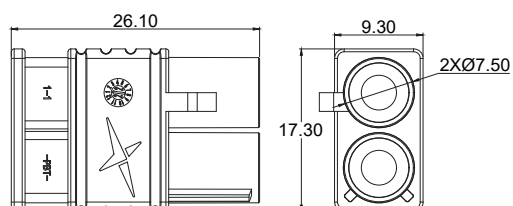

Quad FAKRA Code A Black Female Jack for RG-174/RG-316/TGC-1.5DS

Part Number

FKQRFAF	VSWR	Frequency	Impedance
	0 ~ 9000MHz	0 ~ 9000MHz	50Ω Nominal

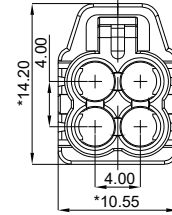
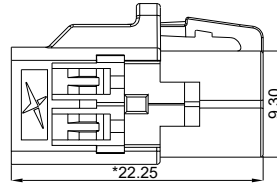

Quad FAKRA Code A Black PCB Mount Male Plug

Part Number

FKQRMAPCB	VSWR	Frequency	Impedance
	0 ~ 9000MHz	0 ~ 9000MHz	50Ω Nominal

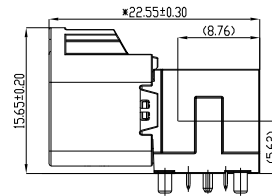
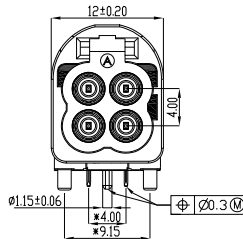

Quad FAKRA Code B White Female Jack for RG-174/RG-316/TGC-1.5DS

Part Number

FKQRFBF	VSWR	Frequency	Impedance
	0 ~ 9000MHz	0 ~ 9000MHz	50Ω Nominal

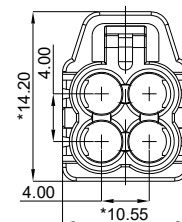
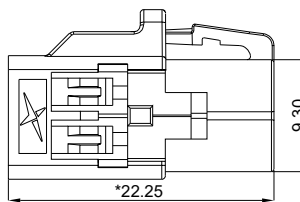

Dual FAKRA Code Z Water Blue Male PCB Mount Male Plug

Part Number

FKQRMBPCB	VSWR	Frequency	Impedance
	0 ~ 9000MHz	0 ~ 9000MHz	50Ω Nominal

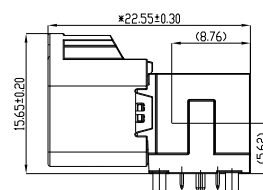
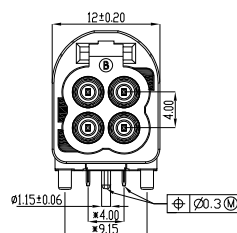

Quad FAKRA Code C Blue Female Jack for RG-174/RG-316/TGC-1.5DS

Part Number

FKQRFCF	VSWR	Frequency	Impedance
	0 ~ 9000MHz	0 ~ 9000MHz	50Ω Nominal

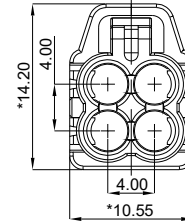
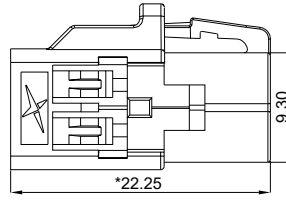

Quad FAKRA Code C Blue Male PCB Mount Male Plug

Part Number

FKQRMPCB	VSWR	Frequency	Impedance
	0 ~ 9000MHz	0 ~ 9000MHz	50Ω Nominal

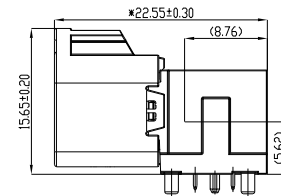
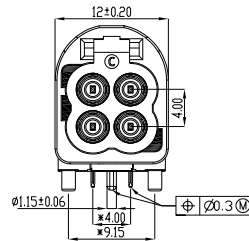

Quad FAKRA Code D Bordeaux Violet Female Jack for RG-174/RG-316/TGC-1.5DS

Part Number

FKQRDFD	VSWR	Frequency	Impedance
	0 ~ 9000MHz	0 ~ 9000MHz	50Ω Nominal

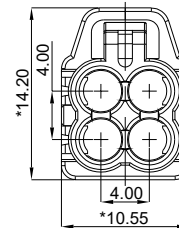
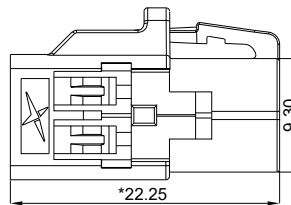

Quad FAKRA Code D Bordeaux Violet Male PCB Mount Male Plug

Part Number

FKQRMDPCB	VSWR	Frequency	Impedance
	0 ~ 9000MHz	0 ~ 9000MHz	50Ω Nominal

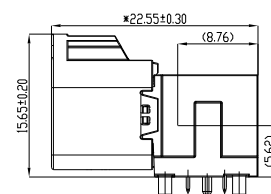
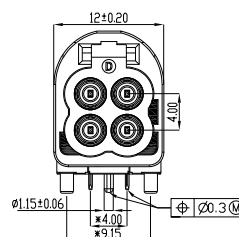

Quad FAKRA Code E Green Female Jack for RG-174/RG-316/TGC-1.5DS

Part Number

FKQRFEF	VSWR	Frequency	Impedance
	0 ~ 9000MHz	0 ~ 9000MHz	50Ω Nominal

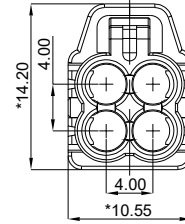
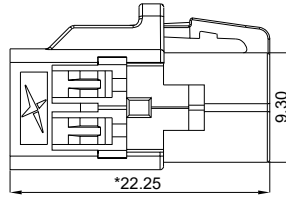

Quad FAKRA Code E Green Male PCB Mount Male Plug

Part Number

FKQRMEPCB	VSWR	Frequency	Impedance
	0 ~ 9000MHz	0 ~ 9000MHz	50Ω Nominal

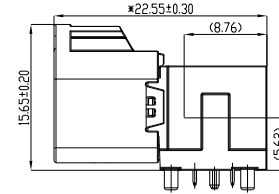
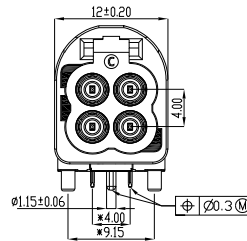

Quad FAKRA Code F Brown Female Jack for RG-174/RG-316/TGC-1.5DS

Part Number

FKQRFFF	VSWR	Frequency	Impedance
	0 ~ 9000MHz	0 ~ 9000MHz	50Ω Nominal

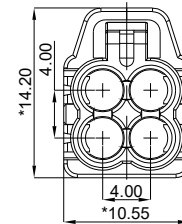
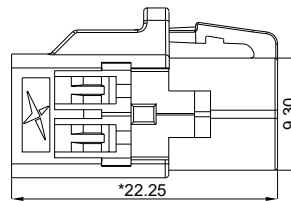

Quad FAKRA Code F Brown Male PCB Mount Male Plug

Part Number

FKQRMFPCB	VSWR	Frequency	Impedance
	0 ~ 9000MHz	0 ~ 9000MHz	50Ω Nominal

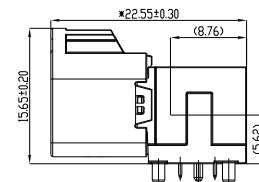
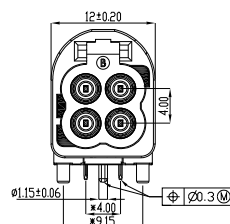

Quad FAKRA Code Z Water Blue Female Jack for RG-174/RG-316/TGC-1.5DS

Part Number

FKQRZFF	VSWR	Frequency	Impedance
	0 ~ 9000MHz	0 ~ 9000MHz	50Ω Nominal

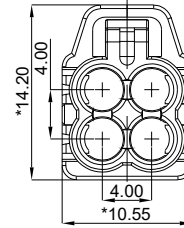
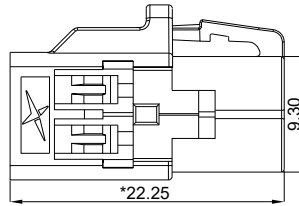

Quad FAKRA Code Z Water Blue Male PCB Mount Male Plug

Part Number

FKQRMZPCB	VSWR	Frequency	Impedance
	0 ~ 9000MHz	0 ~ 9000MHz	50Ω Nominal

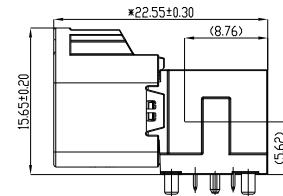
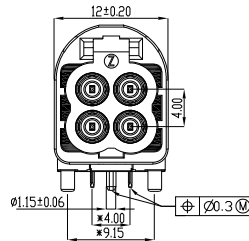

Product Compatibility Table

Mount/ Cable	Colour Code	Part Number	Series Gen -01						
			Single FAKRA		Dual FAKRA		Quad FAKA		
			Plug	Jack	Plug	Jack	Plug	Jack	
RG-174/RG316	Beige	FK0MIDK	●						
	Beige	FK1FIDK		●					
	Beige	FKDFIDK				●			
	Beige	FKDMIDK			●				
	Black	FK0MADK	●						
	Black	FK1FADK		●					
	Blue	FK0MCDK	●						
	Blue	FK1FCDK		●					
	Blue	FKQRFCF						●	
	Bordeaux Vilot	FK0MDDK	●						
	Bordeaux Vilot	FK1FDDK		●					
	Bordeaux Vilot	FKQRDFD						●	
	Bordeaux Vilot	FKDFDDK			●				
	Bordeaux Vilot	FKDMDDK				●			
	Brown	FKQRFAF						●	
	Brown	FKQRFFF						●	
	Carmine Red	FK0MLDK	●						
	Carmine Red	FK1FLDK		●					
	Curry Yellow	FK0MKDK	●						
	Curry Yellow	FK1FKDK		●					
	Leaf Green	FKQRFEF						●	
	Water Blue	FK0MZDK	●						
	Water Blue	FK1FZDK		●					
	Water Blue	FKQRZDF						●	
	Water Blue	FKDFZDK				●			
	Water Blue	FKDMZDK			●				
	White	FKQRFBF						○	
	TGC-200/CFD-200	Beige	FK0MIG	●					
		Beige	FK1FIG		●				
		Beige	FKDFIG				●		
		Beige	FKDMIG			●			
		Blue	FK0MCG	●					
Blue		FK1FCG		●					
Bordeaux Vilot		FK0MDG	●						
Bordeaux Vilot		FK1FDG		●					
Bordeaux Vilot		FKDFDG			●				
Bordeaux Vilot		FKDMDG			●				
Carmine Red		FK0MLG	●						
Carmine Red		FK1FLG		●					
Curry Yellow		FK0MKG	●						
Curry Yellow		FK1FKG		●					
Water Blue		FK0MZG	●						
Water Blue		FK1FZG		●					
Water Blue	FKDFZG			●					
Water Blue	FKDMZG		●						
PCB Mount	Black	FKQRMAPCB						●	
	Blue	FKQRMPCB						●	
	Bordeaux Vilot	FKQRMDPCB						●	
	Brown	FKQRMFPCB						●	
	Leaf Green	FKQRMEPCB						●	
	Water Blue	FKQRMZPCB						●	
White	FKQRMBPCB						○		

7. 2.92mm Adaptors & Connectors

2.92mm 40GHz Rated Adaptors

2.92(F) to SMA(F) mmWave Adaptor

Part Number

292FST.SMAF.N.XS	VSWR	Return Loss	Insertion Loss	Frequency	Impedance
	≤1.15	> -19.085dB	0.32dB	27GHz	50Ω

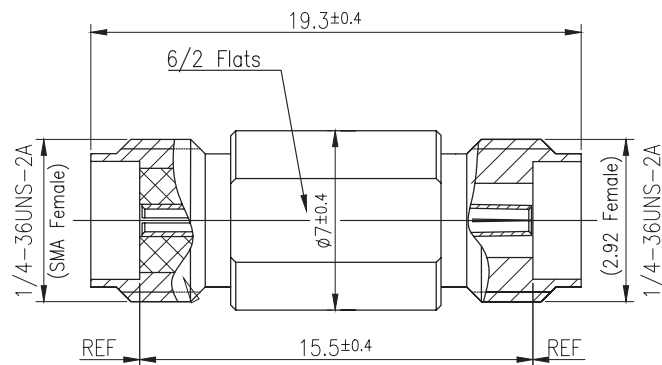

2.92(F) to SMP(F) mmWave Adaptor

Part Number

292FST.SMPF.N.XS	VSWR	Return Loss	Insertion Loss	Frequency	Impedance
	≤1.25	> -17.692dB	0.32dB	40GHz	50Ω

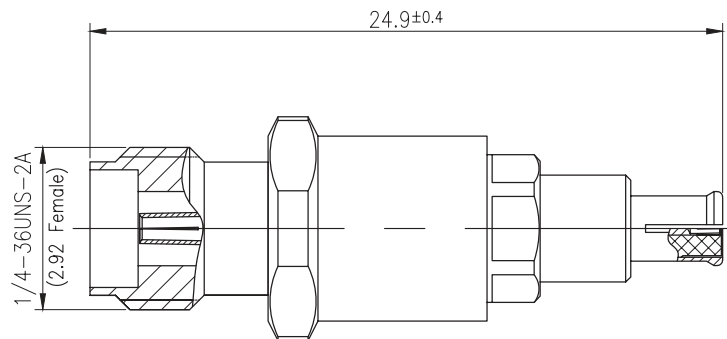

2.92(F) to 2.4(F) mmWave Adaptor

Part Number

292FST.24F.N.XS	VSWR	Return Loss	Insertion Loss	Frequency	Impedance
	≤1.20	> -20.828dB	0.32dB	40GHz	50Ω

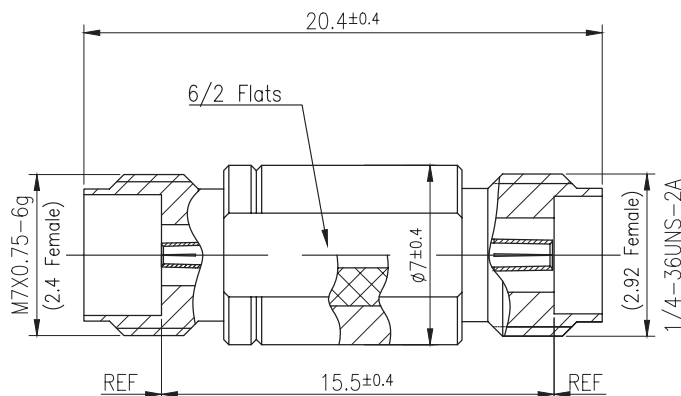

2.92(F) to 2.4(M) mmWave Adaptor

Part Number

292FST.24M.N.XS	VSWR	Return Loss	Insertion Loss	Frequency	Impedance
	≤ 1.20	> -19.085dB	0.32dB	40GHz	50Ω

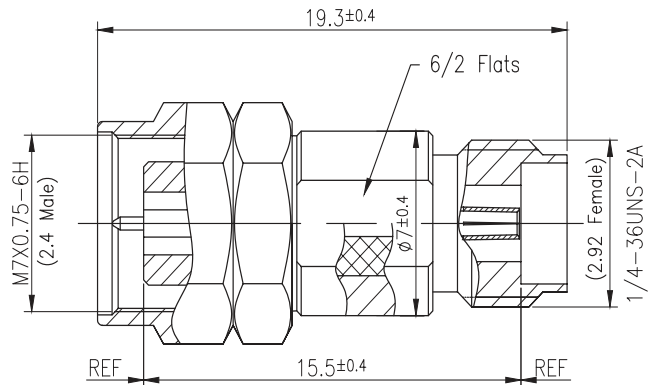

2.92(F) to 2.92(F) mmWave Adaptor

Part Number

292FST.292F.N.XS	VSWR	Return Loss	Insertion Loss	Frequency	Impedance
	≤ 1.20	> -19.085dB	0.32dB	40GHz	50Ω

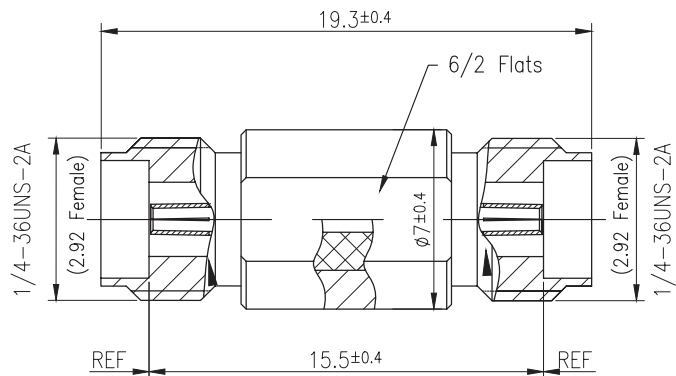

2.92mm 40GHz Connectors - PCB Mount

2.92(F) V Mount 2 Hole Vertical Mount Straight Receptacle (Without Screws)

Part Number

PCB.292FST.2H.XS	VSWR	Return Loss	Insertion Loss	Frequency	Impedance
	≤ 1.20	> -17.692dB	0.38dB	40GHz	50Ω

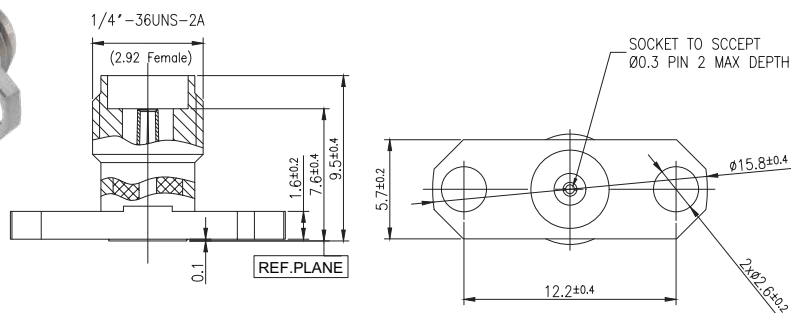

2.92(F) V Mount 4 Hole Vertical Mount Straight Receptacle (Without Screws)

Part Number

PCB.292FST.4H.XS	VSWR	Return Loss	Insertion Loss	Frequency	Impedance
	≤1.20	> -20.828dB	0.38dB	40GHz	50Ω

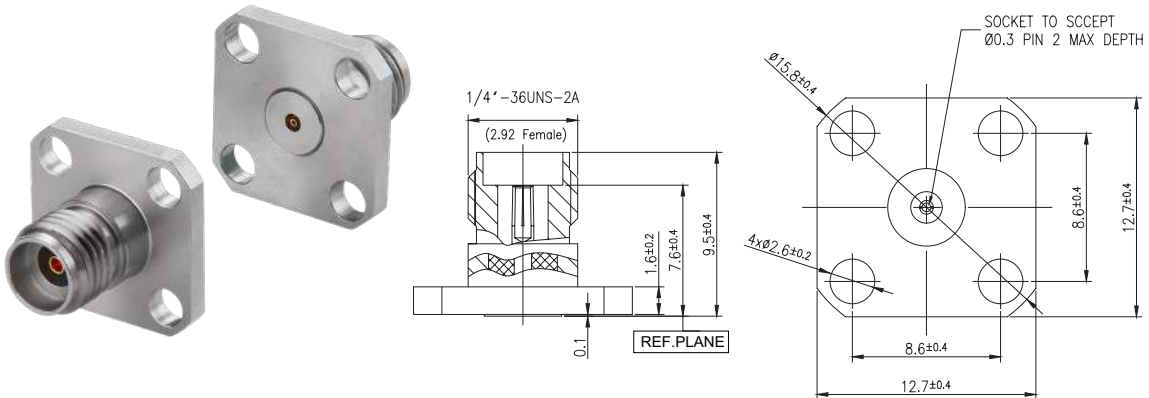

2.92(F) PCB Vertical on board Connector

Part Number

VMPCB.292FST.A.XS	VSWR	Return Loss	Insertion Loss	Frequency	Impedance
	≤1.20	> -17.692dB	0.38dB	40GHz	50Ω

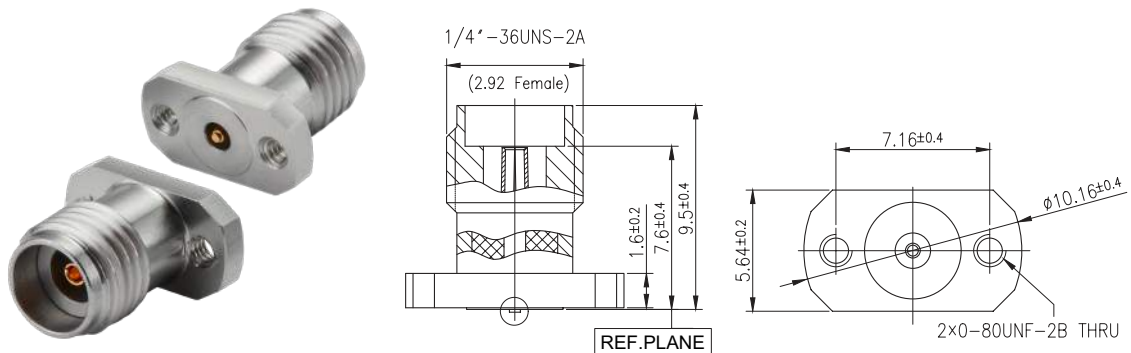

2.92(F) Edge Mount PCB on board Connector

Part Number

EMPCB.292FST.A.XS	VSWR	Return Loss	Insertion Loss	Frequency	Impedance
	≤1.25	> -15.563dB	0.35dB	40GHz	50Ω

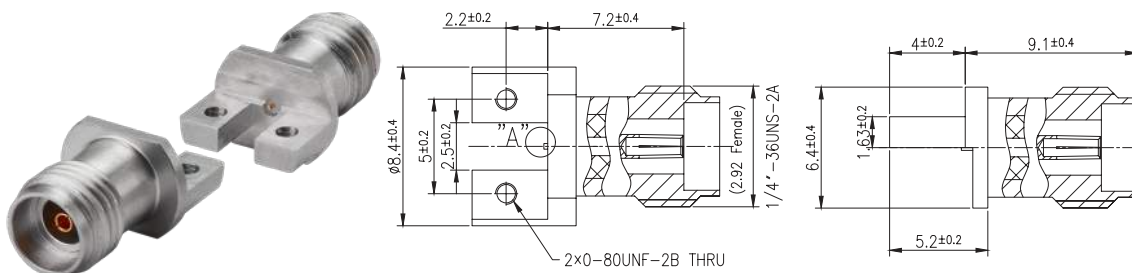

8. Receptacles

Receptacles

TXR™ 1 SMD U.FL Compatible Receptacle

Part Number

RECE.20279.001E.01	VSWR	Return Loss	Insertion Loss	Frequency	Impedance
	≤1.15	> -19.085dB	>0.5dB	10GHz	50Ω

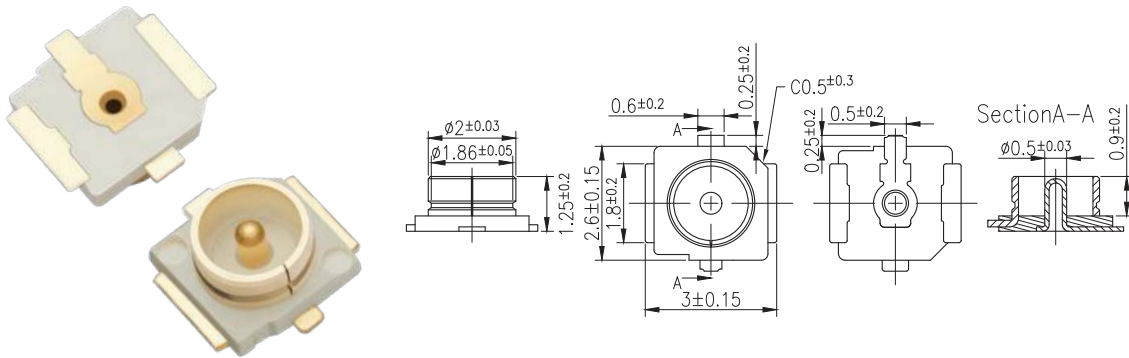

TXR™ 3 SMD W.FL Compatible Receptacle

Part Number

RECE.20369.001E.01	VSWR	Return Loss	Insertion Loss	Frequency	Impedance
	≤1.4	> -17.692dB	> -1dB	6GHz	50Ω

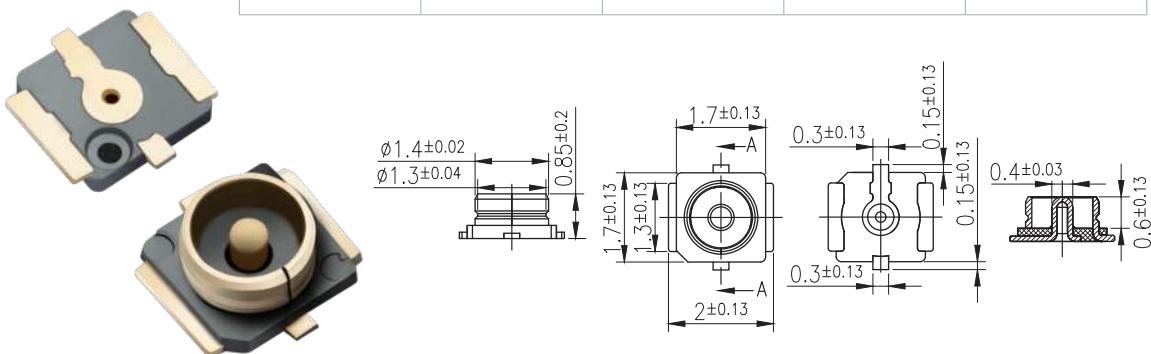

TXR™ 4 Series SMD I-PEX MHF®4 / HSC Compatible Receptacle

Part Number

RECE.20449.001E.01	VSWR	Return Loss	Insertion Loss	Frequency	Impedance
	≤1.4	> -20.828dB	> -1dB	10GHz	50Ω

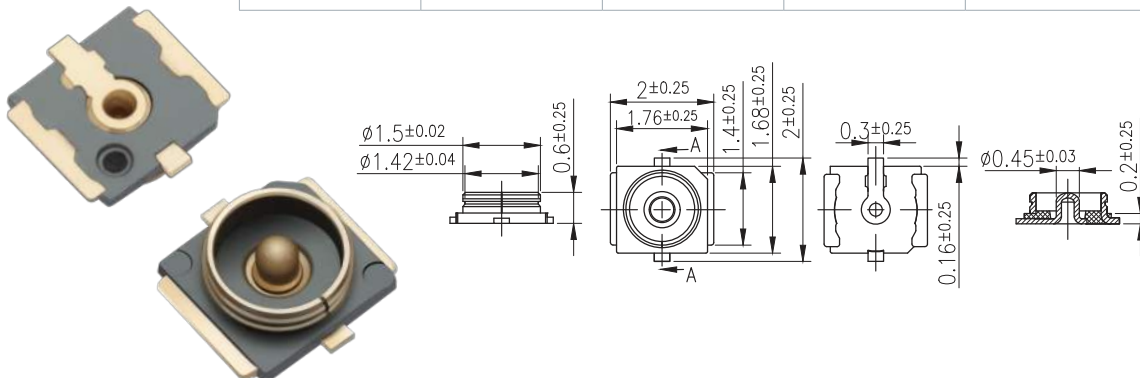



EMEA

Email - emeasales@taoglas.com
Phone - +353 53 9169500

NASAC

Email - nasales@taoglas.com
Phone - +1 858-450-0888

APAC

Email - asiasales@taoglas.com
Phone - +886 3 3681223

Contact us for quick and professional support from our senior engineering team to manage and develop your next IoT project.

www.taoglas.com