

TABLE OF LENGTH TOLERANCES [mm]

| Over | Up to and Including | Tolerance |
|-------|---------------------|-----------|
| 0 | 1000 | ±20 |
| 1000 | 3000 | ±30 |
| 3000 | 5000 | ±40 |
| 5000 | 10000 | ±50 |
| 10000 | 15000 | ±100 |
| 15000 | 20000 | ±150 |
| 20000 | | ±L/100 |

INSERT ORIENTATION

| Housing 2 Poles + 2 Earths | Housing 3 Poles + 1 Earth |
|--|--|
| Earth H6/H12 E452XXXXXX1XXXX | Earth H12 E452XXXXXX2XXXX PIN 3 Not Used |
| Earth H3/H9 E452XXXXXX4XXXX | Earth H3 E452XXXXXX3XXXX PIN 3 Not Used |
| Earth H6/H12 E452XXXXXX1XC3X E452XXXXXX1XC7X E452XXXXXX1XR0X E452XXXXXX1XR2X | Earth H6 E452XXXXXX6XXXX PIN 3 Not Used |
| Insert rotated 180° | Earth H9 E452XXXXXX9XXXX PIN 3 Not Used |

Type of Screws and Gaskets

| Profiled Gasket | Flat Gasket | Integrated Gasket | Screw M3x25 |
|------------------------------|----------------------------|---|--|
| <p>(□ 29.5)</p> <p>(5.2)</p> | <p>(□ 28)</p> <p>(1.8)</p> | <p>(□ 28)</p> <p>(1.8)</p> <p>(9.3)</p> | <p>(25)</p> <p>M 3</p> |
| | | | Screw M3x27 + Washer <p>(27)</p> <p>M 3</p> <p>NBR Washer</p> |

THIS DRAWING CONTAINS INFORMATION THAT IS PROPRIETARY TO MOLEX ELECTRONIC TECHNOLOGIES, LLC AND SHOULD NOT BE USED WITHOUT WRITTEN PERMISSION

| | | | | | |
|---------------------------------------|--|-------|--|--------------------|----------------|
| SYMBOLS | DIMENSION UNITS | SCALE | CURRENT REV DESC: | | |
| | mm | 1:1 | | | |
| GENERAL TOLERANCES (UNLESS SPECIFIED) | | | molex STANDARD E452 DIN FORM A EN 175301-803 | | |
| ANGULAR TOL ± ° | | | | | |
| ▽ = 0 | 4 PLACES ± | | EC NO: 603741 | | |
| ▽ = 0 | 3 PLACES ± | | DRWN: APAWLAK01 | 2018/07/13 | |
| ▽ = 0 | 2 PLACES ± | | CHK'D: RSILLER | 2018/08/31 | |
| ▽ = 0 | 1 PLACE ± | | APPR: RSILLER | 2018/08/31 | |
| □ = 0 | 0 PLACES ± | | INITIAL REVISION: | | |
| ■ = 0 | DRAFT WHERE APPLICABLE MUST REMAIN WITHIN DIMENSIONS | | DRWN: APAWLAK01 | 2018/07/13 | |
| ▽ = 0 | THIRD ANGLE PROJECTION | | APPR: RSILLER | 2018/08/31 | |
| DRAWING | | | SERIES | MATERIAL NUMBER | CUSTOMER |
| A3-SIZE | | | 121050 | SEE 1210502000_PDP | GENERAL MARKET |
| DOCUMENT NUMBER | | | DOC TYPE | DOC PART | REVISION |
| 1210502000 | | | PSD | 000 | A |
| DOCUMENT STATUS | | | SHEET NUMBER | | |
| P1 RELEASE DATE 2018/08/31 12:24:53 | | | 1 OF 3 | | |

PN KEY ENGINEERING PN

E 4 5 2 X X X X X X X X X X

E - Packing without bag
W - Single Packing

Number of wires:
2 - 2 Wires + Earth

Cable type:
See Table

Head Colour:
G - Grey
N - Black
A - CSA-UL Black
B - CSA-UL Grey

Cable Length in[cm]
050 = 50cm
300 = 300cm
10K = 1000cm

Wiring Configuration:
See sheet 3

Voltage and Led Colour

| | | |
|----------|------------|-------------|
| Red Led: | Green Led: | Yellow Led: |
| 1 = 12V | A = 12V | G = 12V |
| 2 = 24V | B = 24V | H = 24V |
| 3 = 48V | C = 48V | K = 48V |
| 4 = 115V | D = 115V | L = 115V |
| 5 = 230V | E = 230V | M = 230V |

Earth PIN location (see insert orientation table):
1 = Double Earth on H6 & H12
2 = Earth on H12
3 = Earth on H3
4 = Double Earth on H3 & H9
6 = Earth on H6
9 = Earth on H9

Type of Gasket and Screw (see sheet 1):
1 = NBR Profile Gasket + Fixing Screw M3x25mm
2 = NBR Flat Gasket + Fixing Screw M3x25mm
3 = Silicone Profile Gasket + Fixing Screw M3x25mm
4 = Silicone Flat Gasket + Fixing Screw M3x25mm
P = NBR Integrated Gasket + Fixing Screw with Washer M3x27mm Assembled on Connector
R = NBR Integrated Gasket + Fixing Screw with Washer M3x27mm NOT Assembled on Connector
T = NBR Profile Gasket + Fixing Screw with Washer M3x27mm

| CABLE TYPE | NO. OF WIRES | CROSS SECTION | CABLE O.D. | CABLE JACKET | UL | CSA | STATIC: TEMP. / BENDING RADIUS | DYNAMIC: TEMP. / BENDING RADIUS | SHIELD |
|------------|--------------|---------------|-------------|--------------|----------|-----------|--------------------------------|---------------------------------|--------|
| A2 | 3 | AWG 20 | 5.6mm±0.2 | PVC BLACK | UL 2661 | CSA C22.2 | -30°C to +105°C, 10xO.D. | -5°C to +105°C, 15xO.D. | - |
| A3 | 3 | AWG 18 | 6.5mm±0.25 | PVC BLACK | UL 2661 | CSA C22.2 | -30°C to +105°C, 10xO.D. | -5°C to +105°C, 15xO.D. | - |
| B2 | 3 | AWG 20 | 5.6mm±0.2 | PUR BLACK | UL 20668 | CSA C22.2 | -40°C to +90°C, 5xO.D. | -25°C to +90°C, 10xO.D. | - |
| B3 | 3 | AWG 18 | 6.5mm±0.2 | PUR BLACK | UL 20668 | CSA C22.2 | -40°C to +90°C, 5xO.D. | -25°C to +90°C, 10xO.D. | - |
| F4 | 3 | 1mm² | 7.1mm+0.2 | PVC GREY | - | - | -15°C to +70°C, 10xO.D. | -5°C to +60°C, 15xO.D. | - |
| I0 | 3 | 1mm² | 7.6mm±0.2 | PVC GREY | - | - | -25°C to +70°C, 10xO.D. | -5°C to +70°C, 15xO.D. | YES |
| I2 | 3 | 0.5mm² | 5.5mm+0.3 | PVC GREY | - | - | -25°C to +70°C, 10xO.D. | -5°C to +70°C, 15xO.D. | - |
| I3 | 3 | 0.75mm² | 6.0mm±0.2 | PVC GREY | - | - | -25°C to +70°C, 10xO.D. | -5°C to +70°C, 15xO.D. | - |
| I4 | 3 | 1mm² | 7.1mm+0.2 | PVC GREY | - | - | -25°C to +70°C, 10xO.D. | -5°C to +70°C, 15xO.D. | - |
| N2 | 3 | 0.5mm² | 5.6mm±0.7 | PVC BLACK | - | - | -20°C to +70°C, 3xO.D. | -15°C to +70°C, 5xO.D. | - |
| N3 | 3 | 0.75mm² | 6.8mm±0.8 | PVC BLACK | - | - | -20°C to +70°C, 3xO.D. | -15°C to +70°C, 5xO.D. | - |
| N4 | 3 | 1mm² | 7.15mm±0.85 | PVC BLACK | - | - | -20°C to +70°C, 3xO.D. | -15°C to +70°C, 5xO.D. | - |
| P1 | 3 | 0.34mm² | 5.3mm±0.2 | PUR BLACK | - | - | -25°C to +80°C, 10xO.D. | -5°C to +80°C, 15xO.D. | - |
| P2 | 3 | 0.5mm² | 5.5mm+0.3 | PUR BLACK | - | - | -40°C to +90°C, 7.5xO.D. | -15°C to +90°C, 12.5xO.D. | - |
| P3 | 3 | 0.75mm² | 6.5mm±0.2 | PUR BLACK | - | - | -40°C to +90°C, 7.5xO.D. | -15°C to +90°C, 12.5xO.D. | - |
| R4 | 3 | 1mm² | 7.1mm±0.2 | TPR HF BLACK | - | - | - | - | - |
| Y3 | 3 | 0.75mm² | 6.5mm±0.2 | SILICONE RED | - | - | -60°C to +180°C, 15xO.D. | - | - |

Notes:

- Please see excel sheet 1210502000_PDP for currently configured part numbers.
- Drawing is a replacement for: SD-121050-001

| | | | | | |
|---------|---|---------------------------------------|------------------------|----------------------------|--------------------------|
| SYMBOLS | THIS DRAWING CONTAINS INFORMATION THAT IS PROPRIETARY TO MOLEX ELECTRONIC TECHNOLOGIES, LLC AND SHOULD NOT BE USED WITHOUT WRITTEN PERMISSION | | CURRENT REV DESC: | | molex |
| | ▽ = 0 | mm | 1:1 | EC NO: 603741 | |
| | ▽ = 0 | GENERAL TOLERANCES (UNLESS SPECIFIED) | | DRWN: APAWLAK01 2018/07/13 | |
| | ▽ = 0 | ANGULAR TOL ± ° | | CHK'D: RSILLER 2018/08/31 | |
| ▽ = 0 | 4 PLACES | ± | | APPR: RSILLER 2018/08/31 | PRODUCT CUSTOMER DRAWING |
| ▽ = 0 | 3 PLACES | ± | | | DOCUMENT NUMBER |
| ▽ = 0 | 2 PLACES | ± | | | 1210502000 |
| ▽ = 0 | 1 PLACE | ± | | | DOC TYPE |
| ▽ = 0 | 0 PLACES | ± | | | PSD |
| □ = 0 | DRAFT WHERE APPLICABLE MUST REMAIN WITHIN DIMENSIONS | | THIRD ANGLE PROJECTION | DRAWING | SERIES |
| ▽ = 0 | | | | A3-SIZE | 121050 |
| | | | MATERIAL NUMBER | CUSTOMER | SHEET NUMBER |
| | | | SEE 1210502000_PDP | GENERAL MARKET | 2 OF 3 |

WIRING DIAGRAMS

ELECTRICAL DIAGRAM 00



ELECTRICAL DIAGRAM A1

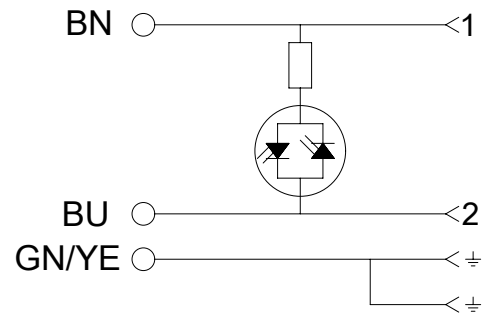

ELECTRICAL DIAGRAM C3

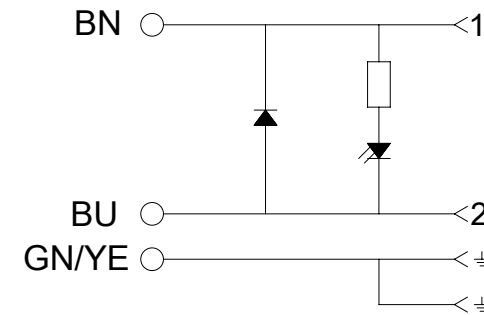

ELECTRICAL DIAGRAM C4

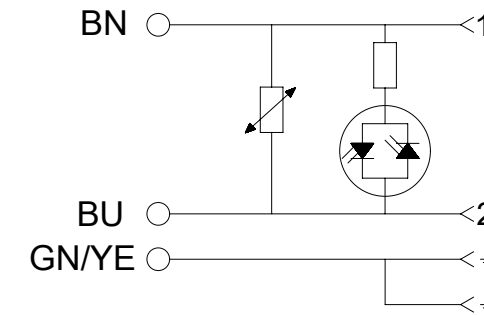

ELECTRICAL DIAGRAM C7



ELECTRICAL DIAGRAM D0

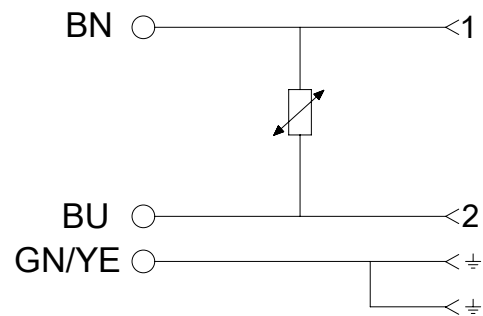

ELECTRICAL DIAGRAM E0

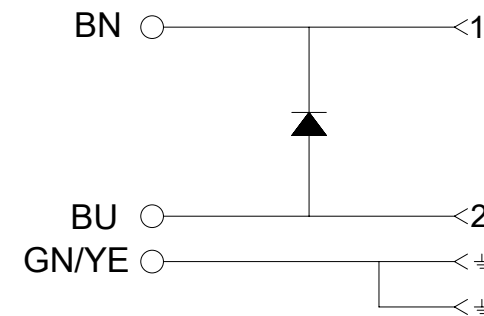

ELECTRICAL DIAGRAM R0

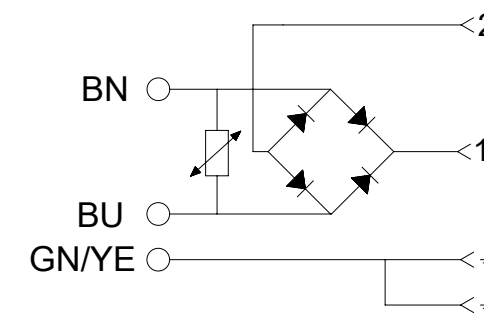

ELECTRICAL DIAGRAM R2



ELECTRICAL DIAGRAM S0

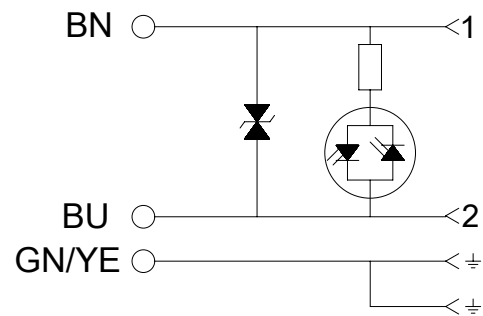

ELECTRICAL DIAGRAM S1

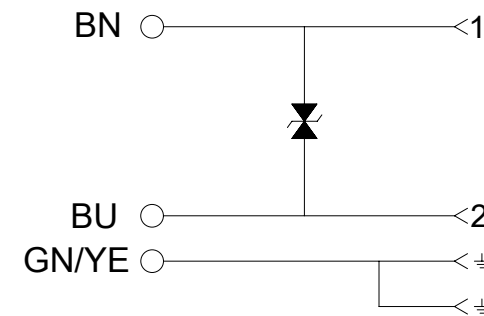

ELECTRICAL DIAGRAM S3

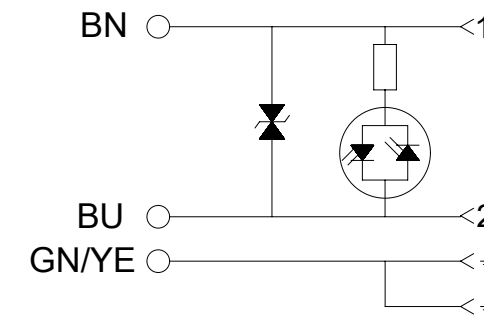

ELECTRICAL DIAGRAM NS



Technical Spec:
 Supply Voltage: See PN KEY
 Max. current: 5A; A1-C4-S0
 1,5A; R2
 Contact Resistance: ≤15milliohms max.
 Operating Temperature:
 with NBR Gasket: -40°C +90°C
 with Silicone: -40°C +125°C

| | | | | | | | | | |
|---|--|--------------------|---|----------------|----------|--------------------|--|----------------|----------|
| THIS DRAWING CONTAINS INFORMATION THAT IS PROPRIETARY TO MOLEX ELECTRONIC TECHNOLOGIES, LLC AND SHOULD NOT BE USED WITHOUT WRITTEN PERMISSION | | | | | | | | | |
| SYMBOLS | DIMENSION UNITS | SCALE | CURRENT REV DESC: | | | | | | |
| | mm | 1:1 | EC NO: 603741 DRWN: APAWLAK01 2018/07/13 CHK'D: RSILLER 2018/08/31 APPR: RSILLER 2018/08/31 INITIAL REVISION: DRWN: APAWLAK01 2018/07/13 APPR: RSILLER 2018/08/31 | | | | | | |
| GENERAL TOLERANCES (UNLESS SPECIFIED) | | | | | | | | | |
| ANGULAR TOL | ± ° | | | | | | | | |
| 4 PLACES | ± | | | | | | | | |
| 3 PLACES | ± | DOCUMENT NUMBER | | DOC TYPE | DOC PART | REVISION | STANDARD E452 DIN FORM A EN 175301-803 PRODUCT CUSTOMER DRAWING | | |
| 2 PLACES | ± | 1210502000 | | PSD | 000 | A | | | |
| 1 PLACE | ± | MATERIAL NUMBER | | CUSTOMER | | SHEET NUMBER | | 3 OF 3 | |
| 0 PLACES | ± | SEE 1210502000_PDP | | GENERAL MARKET | | | | | |
| ☒ = 0 | DRAFT WHERE APPLICABLE MUST REMAIN WITHIN DIMENSIONS | | THIRD ANGLE PROJECTION | | DRAWING | SERIES | MATERIAL NUMBER | | CUSTOMER |
| ▽ = 0 | | | A3-SIZE | | 121050 | SEE 1210502000_PDP | | GENERAL MARKET | |



| | | |
|---|-------------------------------------|------------------------------------|
| DOUBLE EARTH ON 6H & 12H E452XXXXXX1XXXX | EARTH PIN ON 12H E452XXXXXX2XXXX | EARTH PIN ON 6H E452XXXXXX6XXXX |
| DOUBLE EARTH ON 3H & 9H E452XXXXXX4XXXX | EARTH PIN ON 3H E452XXXXXX3XXXX | EARTH PIN ON 9H E452XXXXXX9XXXX |

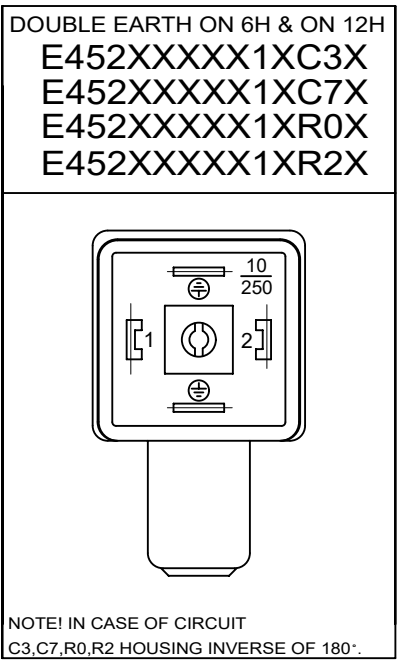

Table of length tolerances [mm]

| Over | Up to and including | Tolerance (+) |
|-------|---------------------|---------------|
| 0 | 1000 | ±20 |
| 1000 | 3000 | ±30 |
| 3000 | 5000 | ±40 |
| 5000 | 10000 | ±50 |
| 10000 | 15000 | ±100 |
| 15000 | 20000 | ±150 |
| 20000 | | ±L/100 |

WIRING CONFIGURATION

| | | |
|------------------------------|------------------------------|------------------------------|
| ELECTRICAL DIAGRAM R0 | ELECTRICAL DIAGRAM C4 | ELECTRICAL DIAGRAM S0 |
| ELECTRICAL DIAGRAM S3 | ELECTRICAL DIAGRAM A1 | ELECTRICAL DIAGRAM C3 |
| ELECTRICAL DIAGRAM E0 | ELECTRICAL DIAGRAM R2 | ELECTRICAL DIAGRAM C7 |
| ELECTRICAL DIAGRAM S1 | ELECTRICAL DIAGRAM 00 | |

NOTES:
1. FOR HARNESS WITH GROUND ONLY IN:
3H,6H,9H or 12H PIN 3 IS N/C.

THIS DRAWING CONTAINS INFORMATION THAT IS PROPRIETARY TO MOLEX ELECTRONIC TECHNOLOGIES, LLC AND SHOULD NOT BE USED WITHOUT WRITTEN PERMISSION

| | | | | | |
|--|------------------------|---|--|--------------------------|-----------------------|
| DIMENSION UNITS: mm | SCALE: NTS | CURRENT REV DESC: REVISION CREATED FOR REMOVING PRE-RELEASE STAMP | molex | | |
| GENERAL TOLERANCES (UNLESS SPECIFIED) | | | | | |
| 4 PLACES ± | MM INCH | EC NO: 714567 | E452XXXXXXXXXX DIN FORM A EN 175301-803 | | |
| 3 PLACES ± | | DRWN: SUGEEB 2022/07/18 | PRODUCT CUSTOMER DRAWING | | |
| 2 PLACES ± | | CHK'D: GGA 2022/07/19 | DOCUMENT NUMBER: SD-121050-001 | | |
| 1 PLACE ± | | APPR: GGA 2022/07/19 | DOC TYPE: PSD | | |
| 0 PLACES ± | | INITIAL REVISION: | DOC PART: 001 | | |
| ANGULAR TOL ± ° | | DRWN: JMARSZALEK 2012/08/27 | REVISION: E1 | | |
| DRAFT WHERE APPLICABLE MUST REMAIN WITHIN DIMENSIONS | FIRST ANGLE PROJECTION | APPR: MDYSZEWSKA 2012/08/20 | MATERIAL NUMBER: SEE TABLE | CUSTOMER: GENERAL MARKET | SHEET NUMBER: 1 OF 41 |

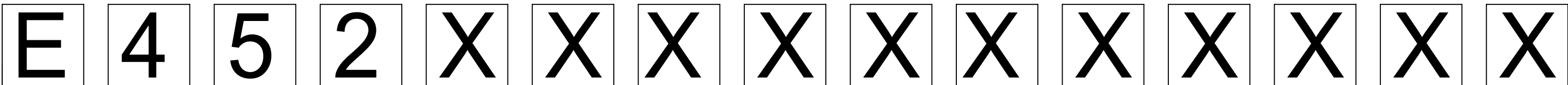

E - Packing without bags
 W - Single packing
 Q - Quick packing

NUMBER OF WIRES:
 1=2 WIRES
 2=2 WIRES + EARTH
 3=3 WIRES + EARTH

CABLE TYPE
 SEE SHEET 3 - TABLE 1

CABLE CROSS SECTION AREA
 SEE SHEET 3 - TABLE 2

HEAD COLOUR:
 N=BLACK;
 A=CSA-UL BLACK;
 B=CSA-UL GREY.

CABLE LENGTH IN CM
 Eg.:050=50 CM, 300=300 CM, 10K=1000 CM.

EARTH PIN LOCATION:
 1=DOUBLE EARTH ON 6H AND 12H,
 2=EARTH ON 12H,
 6=EARTH ON 6H.

TYPE OF GASKET AND SCREW:
 1=NBR PROFILE GASKET + FIXING SCREWS (M3x25 mm).
 2=NBR FLAT GASKET + FIXING SCREW (M3x25 mm).
 3=SILICONE PROFILE GASKET + FIXING SCREW (M3x25 mm).
 4=SILICON FLAT GASKET + FIXING SCREW (M3x25 mm).
 P=INTEGRATED GASKET ASSEMBLED + FIXING SCREW WITH GROMMET ASSEMBLED ON CONNECTOR (M3x27 mm).
 R=INTEGRATED GASKET + FIXING SCREW + GROMMET (M3x27 mm).
 T=PROFILE GASKET + FIXING SCREW + GROMMET (M3x27 mm).

INTERNAL CIRCUIT
 WIRING CONFIGURATION

VOLTAGE AND LED COLOUR:

| | | | | | |
|---------|-----------|---------|-------------|---------|--------------|
| 1= 12V | } RED LED | A= 12V | } GREEN LED | G= 12V | } YELLOW LED |
| 2= 24V | | B= 24V | | H= 24V | |
| 3= 48V | | C= 48V | | K= 48V | |
| 4= 115V | | D= 115V | | L= 115V | |
| 5= 230V | | E= 230V | | M= 230V | |

| | | | | | | | | | | | | |
|---|--|------------------------|--|---|--|-------------------|--|--------------------------|--|--|----------|----------|
| THIS DRAWING CONTAINS INFORMATION THAT IS PROPRIETARY TO MOLEX ELECTRONIC TECHNOLOGIES, LLC AND SHOULD NOT BE USED WITHOUT WRITTEN PERMISSION | | | | | | | | | | | | |
| DIMENSION UNITS mm | | SCALE NTS | | CURRENT REV DESC: REVISION CREATED FOR REMOVING PRE-RELEASE STAMP | | | | molex | | E452XXXXXXXXXX DIN FORM A EN 175301-803 | | |
| GENERAL TOLERANCES (UNLESS SPECIFIED) | | | | | | | | | | | | |
| | | MM | | INCH | | EC NO: 714567 | | DOCUMENT NUMBER | | DOC TYPE | DOC PART | REVISION |
| 4 PLACES ± | | ± | | ± | | DRWN: SUGEEB | | SD-121050-001 | | PSD | 001 | E1 |
| 3 PLACES ± | | ± | | ± | | CHK'D: GGA | | PRODUCT CUSTOMER DRAWING | | | | |
| 2 PLACES ± | | ± | | ± | | APPR: GGA | | SERIES | | | | |
| 1 PLACE ± | | ± | | ± | | INITIAL REVISION: | | MATERIAL NUMBER | | | | |
| 0 PLACES ± | | ± | | ± | | DRWN: JMARSZALEK | | CUSTOMER | | | | |
| ANGULAR TOL ± ° | | ± ° | | ± ° | | APPR: MDYSZEWSKA | | GENERAL MARKET | | | | |
| DRAFT WHERE APPLICABLE MUST REMAIN WITHIN DIMENSIONS | | FIRST ANGLE PROJECTION | | DRAWING | | SERIES | | SHEET NUMBER | | | | |
| | | | | A3-SIZE | | 121050 | | 2 OF 41 | | | | |

TABLE 2 - CABLES

| Molex PN Raw cable | Cable type | Cable code | Wires no. | Cross Section | Jacket material | Jacket color | Diameter Ø [mm] | Wire colors |
|--------------------|------------|------------|-----------|---------------|----------------------|--------------|-----------------|-----------------------|
| 1210180080 | I | 0 | 3 | 1 mm² | PVC CEI 2022 II O.R. | Grey | 6.4±0.2 | BN, BU, GN/YE |
| 1210180467 | A | 2 | 2 | 20 AWG | PVC CSA/UL 2661 | Black | 5.4±0.2 | BN, BU |
| 1210180128 | A | 2 | 3 | 20 AWG | PVC CSA/UL 2661 | Black | 5.6±0.2 | BN, BU, GN/YE |
| 1210180394 | A | 2 | 4 | 20 AWG | PVC CSA/UL 2661 | Black | 6.2±0.25 | BN, BU, BK, GN/YE |
| 1210180297 | B | 2 | 2 | 20 AWG | PUR CSA/UL 20668 | Black | 5.6±0.2 | BN, BU |
| 1210180126 | B | 2 | 3 | 20 AWG | PUR CSA/UL 20668 | Black | 5.6±0.2 | BN, BU, GN/YE |
| 1210180387 | B | 2 | 4 | 20 AWG | PUR CSA/UL 20668 | Black | 6.3±0.2 | BN, BU, BK, GN/YE |
| 1210180122 | D | 2 | 3 | 0.5 mm² | PVC CEI 20-20 | Grey | 5.5±0.2 | BN, BU, GN/YE |
| 1210180047 | I | 2 | 2 | 0.5 mm² | PVC CEI 2022 II O.R. | Grey | 5.5+0.3/-0 | BN, BU |
| 1210180284 | I | 2 | 3 | 0.5 mm² | PVC CEI 2022 II O.R. | Grey | 5.5+0.3/-0 | BN, BU, GN/YE |
| 1210180146 | I | 2 | 4 | 0.5 mm² | PVC CEI 2022 II O.R. | Grey | 6.5±0.2 | BN, BU, BK, GN/YE |
| 1210180177 | I | 2 | 5 | 0.5 mm² | PVC CEI 2022 II O.R. | Grey | 7.0 +0.3/-0 | BN, BU, BK, WH, GN/YE |
| 1210180022 | N | 2 | 2 | 0.5 mm² | PVC H03VV-F | Black | 5.2±0.2 | BN, BU |
| 1202092753 | N | 2 | 3 | 0.5 mm² | PVC H03VV-F | Black | 5.5±0.2 | BN, BU, GN/YE |
| 1210180153 | N | 2 | 4 | 0.5 mm² | PVC H03VV-F | Black | 5.9±0.3 | BN, BU, BK, GN/YE |
| 1210180046 | P | 2 | 2 | 0.5 mm² | PUR - BLEND | Black | 5.5±0.2 | BN, BU |
| 1202092439 | P | 2 | 3 | 0.5 mm² | PUR - BLEND | Black | 5.5 +0.3/-0 | BN, BU, GN/YE |
| 1210180302 | P | 2 | 4 | 0.5 mm² | PUR - BLEND | Black | 6.5±0.2 | BN, BU, BK, GN/YE |
| 1202092215 | P | 2 | 5 | 0.5 mm² | PUR - BLEND | Black | 7+0.3/-0.1 | BN, BU, BK, WH, GN/YE |
| 1210180409 | A | 3 | 2 | 18 AWG | PVC CSA/UL 2661 | Black | 6.2±0.25 | BN, BU |
| 1210180129 | A | 3 | 3 | 18 AWG | PVC CSA/UL 2661 | Black | 6.5±0.25 | BN, BU, GN/YE |
| 1210180159 | A | 3 | 4 | 18 AWG | PVC CSA/UL 2661 | Black | 7.0+0.3/-0 | BN, BU, BK, GN/YE |
| 1210180464 | A | 3 | 5 | 18 AWG | PVC CSA/UL 2661 | Black | 7.8±0.25 | BN, BU, BK, WH, GN/YE |
| 1210180351 | B | 3 | 2 | 18 AWG | PUR CSA/UL 20668 | Black | 6.2±0.2 | BN, BU |
| 1210180127 | B | 3 | 3 | 18 AWG | PUR CSA/UL 20668 | Black | 6.5±0.2 | BN, BU, GN/YE |
| 1210180160 | B | 3 | 4 | 18 AWG | PUR CSA/UL 20668 | Black | 7±0.2 | BN, BU, BK, GN/YE |
| 1210180463 | B | 3 | 5 | 18 AWG | PUR CSA/UL 20668 | Black | 7.8±0.25 | BN, BU, BK, WH, GN/YE |
| 1210180073 | D | 3 | 3 | 0.75 mm² | PVC CEI 20-20 | Grey | 6.5±0.2 | BN, BU, GN/YE |
| 1210180145 | D | 3 | 4 | 0.75 mm² | PVC CEI 20-20 | Grey | 7.1±0.2 | BN, BU, BK, GN/YE |
| 1202098206 | I | 3 | 2 | 0.75 mm² | PVC CEI 2022 II O.R. | Grey | 5.5±0.2 | BK1, BK2 |
| 1210180120 | I | 3 | 3 | 0.75 mm² | PVC CEI 2022 II O.R. | Grey | 6.0±0.2 | BK1, BK2, BK3 |
| 1210180143 | I | 3 | 4 | 0.75 mm² | PVC CEI 2022 II O.R. | Grey | 7.0±0.2 | BN, BU, BK, GN/YE |
| 1210180032 | N | 3 | 2 | 0.75 mm² | PVC H05VV-F | Black | 6.2±0.2 | BN, BU |
| 1210180069 | N | 3 | 3 | 0.75 mm² | PVC H05VV-F | Black | 6.5±0.2 | BN, BU, GN/YE |
| 1210180144 | N | 3 | 4 | 0.75 mm² | PVC H05VV-F | Black | 7.1±0.2 | BN, BU, BK, GN/YE |
| 1210180174 | N | 3 | 5 | 0.75 mm² | PVC H05VV-F | Black | 8.0+0.2/-0 | BN, BU, BK, GY, GN/YE |
| 1202094190 | P | 3 | 2 | 0.75 mm² | PUR - BLEND | Black | 6.5±0.2 | BN, BU |
| 1210180071 | P | 3 | 3 | 0.75 mm² | PUR - BLEND | Black | 6.5±0.2 | BN, BU, GN/YE |
| 1210180152 | P | 3 | 4 | 0.75 mm² | PUR - BLEND | Black | 7.0±0.2 | BN, BU, BK, GN/YE |

TABLE 2 - CABLES

| Molex PN Raw cable | Cable type | Cable code | Wires no. | Cross Section | Jacket material | Jacket color | Diameter Ø [mm] | Wire colors |
|--------------------|------------|------------|-----------|---------------|----------------------|--------------|-----------------|-------------------|
| 1210180384 | R | 3 | 3 | 0.75 mm² | TPR HAL. FREE | Black | 6.5±0.2 | BN, BU, GN/YE |
| 1210180094 | T | 3 | 3 | 0.75 mm² | PUR CSA/UL 20668 | Yellow | 6.5±0.2 | BN, BU, GN/YE |
| 1210180309 | Y | 3 | 3 | 0.75 mm² | SILICONE RUBBER | Red | 6.5±0.2 | BN, BU, GN/YE |
| 1210180081 | F | 4 | 3 | 1 mm² | PVC CNOMO | Grey | 7.1+0.2/-0 | BK1, BK2, GN/YE |
| 1210180042 | I | 4 | 2 | 1 mm² | PVC CEI 2022 II O.R. | Grey | 7.1+0.2/-0 | BN, BU |
| 1210180079 | I | 4 | 3 | 1 mm² | PVC CEI 2022 II O.R. | Grey | 7.1+0.2/-0 | BN, BU, GN/YE |
| 1210180036 | N | 4 | 2 | 1 mm² | PVC H05VV-F | Black | 6.5±0.2 | BN, BU |
| 1210180082 | N | 4 | 3 | 1 mm² | PVC H05VV-F | Black | 6.9±0.2 | BN, BU, GN/YE |
| 1210180117 | R | 4 | 3 | 1 mm² | TPR HAL. FREE | Black | 7.1±0.2 | BN, BU, GN/YE |
| 1210180085 | N | 5 | 3 | 1.5 mm² | PVC H05VV-F | Black | 7.9±0.2 | BN, BU, GN/YE |
| 1210180313 | I | 6 | 2 | 0.35 mm² | PVC CEI 2011 | Grey | 4.8±0.2 | BN, WH |
| 1210180149 | I | 9 | 4 | 0.75 mm² | PVC CEI 2022 II | Grey | 7.3±0.2 | BN, BU, BK, GN/YE |

TABLE 1 - CABLES TYPE

| Code | Cable types | Features | Cable type Cross section |
|------|-------------|---|---------------------------------------|
| N | PVC | Application general purpose cable which has good resistance to water, but usually poor oil resistance. | N2=0.5 mm2 N3=0.75 mm2 N4=1 mm2 |
| I | CEI | Approved to IEC 332-2A, flame retardant and self extinguishing. Limited resistant to mineral oils. | I2=0.5 mm2 I3=0.75 mm2 I4=1 mm2 |
| P | PUR | Offer good resistance to oil and chemicals. Can swell when constantly immersed in water. | P2=0.5 mm2 P3=0.75 mm2 P4=1 mm2 |
| A | PVC CSA-UL | Approved to CSA-UL 2661, application general purpose cable which has good resistance to water, but usually poor oil resistance. | A2=20 AWG A3=18 AWG |
| B | PUR CSA-UL | Approved to CSA-UL 20668, very good resistance to oil and chemicals. | B2=20 AWG B3=18 AWG |

| | | | | | | | | | |
|---|--|-------|--|---|--|----------------|--|---|--|
| THIS DRAWING CONTAINS INFORMATION THAT IS PROPRIETARY TO MOLEX ELECTRONIC TECHNOLOGIES, LLC AND SHOULD NOT BE USED WITHOUT WRITTEN PERMISSION | | | | | | | | | |
| DIMENSION UNITS | | SCALE | | CURRENT REV DESC: REVISION CREATED FOR REMOVING PRE-RELEASE STAMP | | | |  E452XXXXXXXXXX DIN FORM A EN 175301-803 | |
| mm | | NTS | | | | | | | |
| GENERAL TOLERANCES (UNLESS SPECIFIED) | | | | EC NO: 714567 | | 2022/07/18 | | PRODUCT CUSTOMER DRAWING | |
| | | | | DRWN: SUGEEB | | 2022/07/19 | | | |
| | | | | CHK'D: GGA | | 2022/07/19 | | | |
| | | | | APPR: GGA | | | | | |
| | | | | INITIAL REVISION: | | | | DOCUMENT NUMBER | |
| | | | | DRWN: JMARSZALEK | | 2012/08/27 | | SD-121050-001 | |
| | | | | APPR: MDYSZEWSKA | | 2012/08/20 | | PSD 001 E1 | |
| DRAFT WHERE APPLICABLE MUST REMAIN WITHIN DIMENSIONS | | | | FIRST ANGLE PROJECTION | | DRAWING | | SERIES | |
| | | | |  | | A3-SIZE | | 121050 | |
| | | | | MATERIAL NUMBER | | CUSTOMER | | SHEET NUMBER | |
| | | | | SEE TABLE | | GENERAL MARKET | | 3 OF 41 | |

TABLE 3 - PART LIST

| Pos. | Molex PN: | Engineering No.: |
|------|------------|------------------|
| 1 | 1210400514 | E452N3N10012000 |
| 2 | 1210400515 | E452N3N30012000 |
| 3 | 1210400516 | E452N3N50012000 |
| 4 | 1210400517 | E452P3N10012000 |
| 5 | 1210400519 | E452P3N30012000 |
| 6 | 1210400755 | E452N3N2001P000 |
| 7 | 1210400810 | E452N3N15K12000 |
| 8 | 1210400861 | E452N3N10011000 |
| 9 | 1210400896 | E452A2A80012000 |
| 10 | 1210400897 | E452A2A90012000 |
| 11 | 1210400898 | E452A2A70012000 |
| 12 | 1210400899 | E452A2A40012000 |
| 13 | 1210400900 | E452A2A50012000 |
| 14 | 1210400901 | E452N3N13K12000 |
| 15 | 1210400909 | E452A2A60012000 |
| 16 | 1210400957 | E452N3N20012000 |
| 17 | 1210401237 | W452P3N30012000 |
| 18 | 1210401242 | W452N3N50012000 |
| 19 | 1210401265 | W452N3N30012000 |
| 20 | 1210401291 | W452N3N10012000 |
| 21 | 1210500294 | E452A2A20011C4H |
| 22 | 1210500295 | E452A3A10011C42 |
| 23 | 1210500297 | E452A3A30011C44 |
| 24 | 1210500298 | E452A3A30011C4H |
| 25 | 1210500299 | E452A3A30012000 |
| 26 | 1210500301 | E452A3A30012C4H |
| 27 | 1210500302 | E452A3A50012C4L |
| 28 | 1210500311 | E452B3A30012C4H |
| 29 | 1210500312 | E452B3A30012C4L |
| 30 | 1210500313 | E452B3A50012C4H |
| 31 | 1210500314 | E452B8N10012000 |
| 32 | 1210500339 | E452F4N10K11S3B |
| 33 | 1210500344 | E452F4N20011S3B |
| 34 | 1210500352 | E452F4N50011S3B |
| 35 | 1210500362 | E452I0N20011C42 |
| 36 | 1210500375 | E452I2N10011C4H |
| 37 | 1210500376 | E452I2N10011C72 |
| 38 | 1210500384 | E452I2N20011C3H |
| 39 | 1210500385 | E452I2N20011C4H |
| 40 | 1210500388 | E452I2N30011C32 |

| Pos. | Molex PN: | Engineering No.: |
|------|------------|------------------|
| 41 | 1210500389 | E452I2N30011C3H |
| 42 | 1210500390 | E452I2N30011C42 |
| 43 | 1210500392 | E452I2N30011C4H |
| 44 | 1210500393 | E452I2N30011C4L |
| 45 | 1210500394 | E452I2N30011C4M |
| 46 | 1210500398 | E452I2N50011C42 |
| 47 | 1210500399 | E452I2N50011C4H |
| 48 | 1210500407 | E452I4G30011C4B |
| 49 | 1210500408 | E452I4G30011C4H |
| 50 | 1210500414 | E452I4G40011C4H |
| 51 | 1210500417 | E452I4G50011C4H |
| 52 | 1210500424 | E452I4N10011C42 |
| 53 | 1210500428 | E452I4N10011C4H |
| 54 | 1210500434 | E452I4N10K11C4H |
| 55 | 1210500435 | E452I4N10K11C4L |
| 56 | 1210500443 | E452I4N15K11C4H |
| 57 | 1210500448 | E452I4N20011C3H |
| 58 | 1210500452 | E452I4N20011C4H |
| 59 | 1210500455 | E452I4N20011C7H |
| 60 | 1210500465 | E452I4N30011A1H |
| 61 | 1210500467 | E452I4N30011C3H |
| 62 | 1210500468 | E452I4N30011C42 |
| 63 | 1210500469 | E452I4N30011C44 |
| 64 | 1210500473 | E452I4N30011C4H |
| 65 | 1210500474 | E452I4N30011C4L |
| 66 | 1210500475 | E452I4N30011C4M |
| 67 | 1210500478 | E452I4N30011R2H |
| 68 | 1210500479 | E452I4N30011R2L |
| 69 | 1210500480 | E452I4N30011R2M |
| 70 | 1210500481 | E452I4N30011S0H |
| 71 | 1210500486 | E452I4N35011C45 |
| 72 | 1210500489 | E452I4N40011C42 |
| 73 | 1210500492 | E452I4N40011C4H |
| 74 | 1210500498 | E452I4N50011C3H |
| 75 | 1210500499 | E452I4N50011C42 |
| 76 | 1210500504 | E452I4N50011C4H |
| 77 | 1210500505 | E452I4N50011C4L |
| 78 | 1210500506 | E452I4N50011C4M |
| 79 | 1210500510 | E452I4N50011R2L |
| 80 | 1210500511 | E452I4N50011S0H |

| Pos. | Molex PN: | Engineering No.: |
|------|------------|------------------|
| 81 | 1210500514 | E452I4N55011C72 |
| 82 | 1210500515 | E452I4N60011C42 |
| 83 | 1210500520 | E452I4N70011R2H |
| 84 | 1210500522 | E452I4N80011C4H |
| 85 | 1210500524 | E452I8N50011C4H |
| 86 | 1210500548 | E452N3N10011A11 |
| 87 | 1210500549 | E452N3N10011C42 |
| 88 | 1210500551 | E452N3N10011C45 |
| 89 | 1210500552 | E452N3N10011C4B |
| 90 | 1210500554 | E452N3N10011C4H |
| 91 | 1210500556 | E452N3N10011R2H |
| 92 | 1210500558 | E452N3N10012C4H |
| 93 | 1210500559 | E452N3N10012C4L |
| 94 | 1210500560 | E452N3N10022C4L |
| 95 | 1210500562 | E452N3N10K11C42 |
| 96 | 1210500569 | E452N3N10K11S02 |
| 97 | 1210500572 | E452N3N10K11S0H |
| 98 | 1210500575 | E452N3N10K12C4H |
| 99 | 1210500576 | E452N3N10K12C4L |
| 100 | 1210500582 | E452N3N15011A11 |
| 101 | 1210500583 | E452N3N15011A12 |
| 102 | 1210500584 | E452N3N15011A15 |
| 103 | 1210500585 | E452N3N15011C32 |
| 104 | 1210500591 | E452N3N15012C4H |
| 105 | 1210500594 | E452N3N15022C4L |
| 106 | 1210500599 | E452N3N15K12C4H |
| 107 | 1210500601 | E452N3N20011A11 |
| 108 | 1210500602 | E452N3N20011A12 |
| 109 | 1210500603 | E452N3N20011A14 |
| 110 | 1210500606 | E452N3N20011A1H |
| 111 | 1210500612 | E452N3N20011C42 |
| 112 | 1210500620 | E452N3N20011C4H |
| 113 | 1210500621 | E452N3N20011C4L |
| 114 | 1210500624 | E452N3N20011R05 |
| 115 | 1210500627 | E452N3N20011R2M |
| 116 | 1210500636 | E452N3N25011C42 |
| 117 | 1210500638 | E452N3N25011C4H |
| 118 | 1210500644 | E452N3N30011A1H |
| 119 | 1210500648 | E452N3N30011C32 |
| 120 | 1210500649 | E452N3N30011C41 |

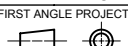
| Pos. | Molex PN: | Engineering No.: |
|------|------------|------------------|
| 121 | 1210500650 | E452N3N30011C42 |
| 122 | 1210500651 | E452N3N30011C44 |
| 123 | 1210500652 | E452N3N30011C45 |
| 124 | 1210500657 | E452N3N30011C4H |
| 125 | 1210500658 | E452N3N30011C4L |
| 126 | 1210500659 | E452N3N30011C4M |
| 127 | 1210500662 | E452N3N30011R2H |
| 128 | 1210500666 | E452N3N30011S0D |
| 129 | 1210500673 | E452N3N30012C4H |
| 130 | 1210500674 | E452N3N30012C4L |
| 131 | 1210500685 | E452N3N35011A11 |
| 132 | 1210500689 | E452N3N40011A12 |
| 133 | 1210500690 | E452N3N40011C42 |
| 134 | 1210500691 | E452N3N40011C44 |
| 135 | 1210500692 | E452N3N40011C45 |
| 136 | 1210500693 | E452N3N40011C4H |
| 137 | 1210500696 | E452N3N50011A1B |
| 138 | 1210500702 | E452N3N50011C42 |
| 139 | 1210500703 | E452N3N50011C44 |
| 140 | 1210500705 | E452N3N50011C4B |
| 141 | 1210500707 | E452N3N50011C4D |
| 142 | 1210500708 | E452N3N50011C4E |
| 143 | 1210500709 | E452N3N50011C4H |
| 144 | 1210500711 | E452N3N50011S02 |
| 145 | 1210500712 | E452N3N50011S0D |
| 146 | 1210500713 | E452N3N50011S0H |
| 147 | 1210500714 | E452N3N50012C44 |
| 148 | 1210500715 | E452N3N50012C4H |
| 149 | 1210500716 | E452N3N50012C4L |
| 150 | 1210500722 | E452N3N65021C42 |
| 151 | 1210500730 | E452P2N04011C4H |
| 152 | 1210500735 | E452P2N07511C32 |
| 153 | 1210500737 | E452P2N10011C4H |
| 154 | 1210500739 | E452P2N10K11C4H |
| 155 | 1210500741 | E452P2N10K11S0H |
| 156 | 1210500742 | E452P2N11011C4H |
| 157 | 1210500747 | E452P2N16011C4H |
| 158 | 1210500748 | E452P2N20011C4H |
| 159 | 1210500755 | E452P2N30011C4L |
| 160 | 1210500759 | E452P2N30011S0H |

THIS DRAWING CONTAINS INFORMATION THAT IS PROPRIETARY TO MOLEX ELECTRONIC TECHNOLOGIES, LLC AND SHOULD NOT BE USED WITHOUT WRITTEN PERMISSION

| | | | | | | |
|--|---------------------|---|--|----------------------|-----------------|----------|
| DIMENSION UNITS mm | SCALE NTS | CURRENT REV DESC: REVISION CREATED FOR REMOVING PRE-RELEASE STAMP | molex | | | |
| GENERAL TOLERANCES (UNLESS SPECIFIED) | | | | | | |
| | | EC NO: 714567 DRWN: SUGEEB CHK'D: GGA APPR: GGA | E452XXXXXXXXXX DIN FORM A EN 175301-803 | | | |
| | | | PRODUCT CUSTOMER DRAWING | | | |
| | | | INITIAL REVISION: | DOCUMENT NUMBER | DOC TYPE | DOC PART |
| | | | DRWN: JMARSZALEK APPR: MDYSZEWSKA | SD-121050-001 | PSD | 001 |
| ANGULAR TOL ± ° | | 2012/08/27 2012/08/20 | REVISION | E1 | | |
| DRAFT WHERE APPLICABLE MUST REMAIN WITHIN DIMENSIONS | | FIRST ANGLE PROJECTION | DRAWING | SERIES | MATERIAL NUMBER | |
| | | | A3-SIZE | 121050 | SEE TABLE | |
| | | | CUSTOMER | GENERAL MARKET | | |
| | | | | | SHEET NUMBER | |
| | | | | | 4 OF 41 | |

TABLE 3 - PART LIST

| Pos. | Molex PN: | Engineering No.: |
|------|------------|------------------|
| 481 | 1210502984 | E452A3A10K11C7H |
| 482 | 1210502985 | E452P1N15K11C45 |
| 483 | 1210502987 | E452R4N3001PR2E |
| 484 | 1210502988 | E452N3N30022C4H |
| 485 | 1210502989 | E452N3N30022C4M |
| 486 | 1210502991 | E452N2N30011C31 |
| 487 | 1210502994 | E452N2N20061C42 |
| 488 | 1210502997 | E452N3N50041C42 |
| 489 | 1210503000 | E452P2N10011C3B |
| 490 | 1210503001 | E452R4N3001PR2M |
| 491 | 1210503005 | E452P3N12K11C4H |
| 492 | 1210503007 | E452P3N10011R2B |
| 493 | 1210503008 | E452N3N3001GC4M |
| 494 | 1210503013 | E452I2N10011C42 |
| 495 | 1210503014 | E452N2N30021A12 |
| 496 | 1210503017 | E452I2N30021C3H |
| 497 | 1210503018 | E452N3N30011R22 |
| 498 | 1210503020 | W452A3A15K1RS0H |
| 499 | 1210503022 | E452A2A10K11S0L |
| 500 | 1210503026 | E452N2N15011C42 |
| 501 | 1210503030 | E452N2N03011C4H |
| 502 | 1210503032 | W452P3N2001RC4E |
| 503 | 1210503039 | E452N3N55011D02 |
| 504 | 1210503041 | W452N3N5001RR2D |
| 505 | 1210503042 | E452P3N5001PS0E |
| 506 | 1210503046 | E452N3N2001NC31 |
| 507 | 1210503047 | E452B3A50063C4L |
| 508 | 1210503048 | E452B3A50023C4L |
| 509 | 1210503049 | E452A2A70011S0H |
| 510 | 1210503050 | E452N3N30013C4G |
| 511 | 1210503051 | E452N3N50013C4G |
| 512 | 1210503053 | W452N3N2001RC4C |
| 513 | 1210503056 | E452B3A10K1PR2D |
| 514 | 1210503101 | E452N2N30011R2B |
| 515 | 1210503102 | E452N3N3001RC41 |
| 516 | 1210503104 | E452A3A15011S0H |
| 517 | 1210503105 | E452A3A30011S0H |
| 518 | 1210503106 | E452A3A75011S0H |
| 519 | 1210503112 | E452I0N30011C4H |
| 520 | 1210503113 | E452N3N5001RC4B |

| Pos. | Molex PN: | Engineering No.: |
|------|------------|------------------|
| 521 | 1210503119 | E452I4N80011C7H |
| 522 | 1210503120 | E452I4N3006PC3B |
| 523 | 1210503123 | E452A3A15K1RS0H |
| 524 | 1210503130 | W452N3N5001RR25 |
| 525 | 1210503131 | E452I2N5006PC3B |
| 526 | 1210503132 | W452N3N3001RC41 |
| 527 | 1210503135 | E452N2N10011C4D |
| 528 | 1210503138 | E452N3N5001RC41 |
| 529 | 1210503139 | E452N2N30011R05 |
| 530 | 1210503140 | E452B3A30011S0H |
| 531 | 1210503142 | E452P3N50011C44 |
| 532 | 1210503191 | E452R4N3001PC4H |
| 533 | 1210503192 | W452A3A10K1RC4M |
| 534 | 1210503195 | E452P3N1501PA1H |
| 535 | 1210503196 | W452N2N30041C4H |
| 536 | 1210503200 | E452P2N20011A12 |
| 537 | 1210503202 | E452B3A10012C41 |
| 538 | 1210503203 | E452B3A10012C4A |
| 539 | 1210503204 | E452N3N10K12C3H |
| 540 | 1210503205 | E452N3N10K12A1H |
| 541 | 1210503213 | W452N3N50012C4H |
| 542 | 1210503214 | W452P3N10012C4H |
| 543 | 1210503215 | W452N3N30012C4H |
| 544 | 1210503216 | W452P3N30012C4H |
| 545 | 1210503217 | W452P3N20012C4H |
| 546 | 1210503219 | E452I4N30011A1G |
| 547 | 1210503221 | W452I4N30011R2H |
| 548 | 1210503222 | W452I4N30011R2L |
| 549 | 1210503223 | W452I4N30011R2M |
| 550 | 1210503229 | E452N2N25011C42 |
| 551 | 1210503231 | E452N3N1001PC4M |
| 552 | 1210503233 | W452N3N30012C4L |
| 553 | 1210503234 | W452P3N50012C4H |
| 554 | 1210503237 | E452P3N5001PC3H |
| 555 | 1210503238 | E452P3N3001PC3H |
| 556 | 1210503242 | E452P3N10K1PC45 |
| 557 | 1210503243 | E452P3N5001PC45 |
| 558 | 1210503244 | E452P3N15K1PC45 |
| 559 | 1210503248 | E452B2A50011C4H |
| 560 | 1210503256 | E452A3A10K12A1H |

| Pos. | Molex PN: | Engineering No.: |
|------|------------|------------------|
| 561 | 1210503257 | E452A3A10K12C3H |
| 562 | 1210503258 | W452N3N30012C4H |
| 563 | 1210503261 | E452N3N3001PC4M |
| 564 | 1210503263 | W452B3A3001PA1H |
| 565 | N/A | N/A |
| 566 | 1210503265 | E452A2A10011C4H |
| 567 | 1210503266 | W452N2N30011C42 |
| 568 | 1210503267 | W452N2N25011C42 |
| 569 | 1210503268 | W452A3A50011C7H |
| 570 | 1210503269 | W452N3N10012C4H |
| 571 | 1210503270 | W452N3N50012C4L |
| 572 | 1210503274 | E452N2N10K11C42 |
| 573 | 1210503275 | E452I4N30011C41 |
| 574 | 1210503277 | E452I4N30011C31 |
| 575 | N/A | N/A |
| 576 | 1210503286 | E452P3N3001PC4M |
| 577 | 1210503287 | E452P3N3001PC4L |
| 578 | 1210503326 | W452N3N90012C4H |
| 579 | 1210503330 | E452I4N5001PC3H |
| 580 | 1210503332 | E452P3N10K1PA1H |
| 581 | 1210503333 | E452P3N20K1PA1H |
| 582 | 1210503339 | E452P3N1001PC4M |
| 583 | 1210503340 | E452I4G30011C3H |
| 584 | 1210503341 | E452I4G50011C3H |
| 585 | 1210503344 | E452B3A20K11S0H |
| 586 | 1210503347 | E452N3N3001PC4G |
| 587 | 1210503351 | E452N3N3001PA1G |
| 588 | 1210503357 | E452N3N60011C4H |
| 589 | 1210503359 | E452N3N1001PC42 |
| 590 | 1210503360 | E452N3N1001PC44 |
| 591 | 1210503361 | E452N3N1001PC45 |
| 592 | 1210503362 | E452N3N3001PC44 |
| 593 | 1210503363 | E452N3N3001PC45 |
| 594 | 1210503364 | E452N3N5001PC42 |
| 595 | 1210503365 | E452N3N5001PC44 |
| 596 | 1210503366 | E452N3N5001PC45 |
| 597 | 1210503403 | E452B3A06011A12 |
| 598 | 1210503411 | E452P3N1501PC4H |
| 599 | 1210503415 | E452I4N40011C4L |
| 600 | 1210503416 | E452I4G50011C4L |

| Pos. | Molex PN: | Engineering No.: |
|------|------------|------------------|
| 601 | N/A | N/A |
| 602 | 1210503424 | E452N2N2001RA1H |
| 603 | 1210503435 | E452R4N4001PR2E |
| 604 | 1210503441 | E452B2A1501PS3H |
| 605 | 1210503442 | E452P3N30011C7H |
| 606 | 1210503443 | E452N3N10011D05 |
| 607 | 1210503444 | E452P2N75011C4M |
| 608 | 1210503445 | E452P2N16K11C4M |
| 609 | 1210503446 | E452P2N22K11C4M |
| 610 | 1210503463 | E452N3N05011C41 |
| 611 | 1210503464 | W452B2A1501PS3H |
| 612 | 1210503467 | E452N3N05011C4A |
| 613 | 1210503481 | E452N3N5001RS0H |
| 614 | 1210503485 | E452I4N1001PC3H |
| 615 | 1210503490 | E452N3N2001PC4B |
| 616 | 1210503491 | E452A3A30011C7H |
| 617 | 1210503497 | E452B2A10K1PC4H |
| 618 | 1210503498 | E452B2A3001PC4H |
| 619 | 1210503499 | E452B2A5001PC4H |
| 620 | 1210503506 | E452B2A10K1PC4L |
| 621 | 1210503507 | E452B2A3001PC4L |
| 622 | 1210503508 | E452B2A5001PC4L |
| 623 | 1210503509 | E452P3N30013C4D |
| 624 | 1210503510 | E452P3N30013R2D |
| 625 | 1210503512 | E452N3N10K1PC4H |
| 626 | 1210503517 | E452N2N1501PS0H |
| 627 | 1210503520 | W452P3N5001RC4D |
| 628 | 1210503521 | W452P3N5001RC4E |
| 629 | 1210503522 | E452P2N5001PS0H |
| 630 | 1210510097 | E452N10261E3552 |
| 631 | 1210510106 | E452N30011C4214 |
| 632 | 1210510124 | E452P10011C4HBH |
| 633 | 1210510133 | E452P20011C4HBH |
| 634 | 1210510139 | E452P30011C4HBH |
| 635 | 2210500959 | E452A2A10011000 |
| 636 | 2210500960 | E452A2A10011A11 |
| 637 | 2210500961 | E452A2A10011A12 |
| 638 | 2210500962 | E452A2A10011A13 |
| 639 | 2210500963 | E452A2A10011A14 |
| 640 | 2210500964 | E452A2A10011A15 |

| | | | | | |
|---|--|---|--|---|--|
| THIS DRAWING CONTAINS INFORMATION THAT IS PROPRIETARY TO MOLEX ELECTRONIC TECHNOLOGIES, LLC AND SHOULD NOT BE USED WITHOUT WRITTEN PERMISSION | | CURRENT REV DESC: REVISION CREATED FOR REMOVING PRE-RELEASE STAMP | |  E452XXXXXXXXXX DIN FORM A EN 175301-803 | |
| DIMENSION UNITS: mm SCALE: NTS | | EC NO: 714567 DRWN: SUGEEB CHK'D: GGA APPR: GGA | | | |
| GENERAL TOLERANCES (UNLESS SPECIFIED) | | 2022/07/18 2022/07/19 2022/07/19 | | PRODUCT CUSTOMER DRAWING | |
| MM INCH 4 PLACES ± ± 3 PLACES ± ± 2 PLACES ± ± 1 PLACE ± ± 0 PLACES ± ± | | INITIAL REVISION: DRWN: JMARSZALEK APPR: MDYSZEWSKA | | DOCUMENT NUMBER: SD-121050-001 DOC TYPE: PSD DOC PART: 001 REVISION: E1 | |
| DRAFT WHERE APPLICABLE MUST REMAIN WITHIN DIMENSIONS | | FIRST ANGLE PROJECTION | | SERIES: A3-SIZE 121050 MATERIAL NUMBER: SEE TABLE CUSTOMER: GENERAL MARKET SHEET NUMBER: 7 OF 41 | |

TABLE 3 - PART LIST

| Pos. | Molex PN: | Engineering No.: |
|------|------------|------------------|
| 841 | 2210501194 | E452A2A15011C3H |
| 842 | 2210501195 | E452A2A15011C3K |
| 843 | 2210501196 | E452A2A15011C3L |
| 844 | 2210501197 | E452A2A15011C3M |
| 845 | 2210501198 | E452A2A15011C41 |
| 846 | 2210501199 | E452A2A15011C42 |
| 847 | 2210501200 | E452A2A15011C43 |
| 848 | 2210501201 | E452A2A15011C44 |
| 849 | 2210501202 | E452A2A15011C45 |
| 850 | 2210501203 | E452A2A15011C4A |
| 851 | 2210501204 | E452A2A15011C4B |
| 852 | 2210501205 | E452A2A15011C4C |
| 853 | 2210501206 | E452A2A15011C4D |
| 854 | 2210501207 | E452A2A15011C4E |
| 855 | 2210501208 | E452A2A15011C4G |
| 856 | 2210501209 | E452A2A15011C4K |
| 857 | 2210501210 | E452A2A15011C4L |
| 858 | 2210501211 | E452A2A15011C4M |
| 859 | 2210501216 | E452A2A15011E05 |
| 860 | N/A | N/A |
| 861 | N/A | N/A |
| 862 | N/A | N/A |
| 863 | N/A | N/A |
| 864 | 2210501231 | E452A2A15011R05 |
| 865 | N/A | N/A |
| 866 | N/A | N/A |
| 867 | N/A | N/A |
| 868 | N/A | N/A |
| 869 | N/A | N/A |
| 870 | N/A | N/A |
| 871 | N/A | N/A |
| 872 | N/A | N/A |
| 873 | N/A | N/A |
| 874 | N/A | N/A |
| 875 | 2210501242 | E452A2A15011R21 |
| 876 | 2210501243 | E452A2A15011R22 |
| 877 | 2210501244 | E452A2A15011R23 |
| 878 | 2210501245 | E452A2A15011R24 |
| 879 | 2210501246 | E452A2A15011R25 |
| 880 | 2210501247 | E452A2A15011R2A |

| Pos. | Molex PN: | Engineering No.: |
|------|------------|------------------|
| 881 | 2210501248 | E452A2A15011R2B |
| 882 | 2210501249 | E452A2A15011R2C |
| 883 | 2210501250 | E452A2A15011R2D |
| 884 | 2210501251 | E452A2A15011R2E |
| 885 | 2210501252 | E452A2A15011R2G |
| 886 | 2210501253 | E452A2A15011R2H |
| 887 | 2210501254 | E452A2A15011R2K |
| 888 | 2210501255 | E452A2A15011R2L |
| 889 | 2210501256 | E452A2A15011R2M |
| 890 | 2210501257 | E452A2A15011S01 |
| 891 | 2210501258 | E452A2A15011S02 |
| 892 | 2210501259 | E452A2A15011S03 |
| 893 | 2210501260 | E452A2A15011S04 |
| 894 | 2210501261 | E452A2A15011S05 |
| 895 | 2210501262 | E452A2A15011S0A |
| 896 | 2210501263 | E452A2A15011S0B |
| 897 | 2210501264 | E452A2A15011S0C |
| 898 | 2210501265 | E452A2A15011S0D |
| 899 | 2210501266 | E452A2A15011S0E |
| 900 | 2210501267 | E452A2A15011S0G |
| 901 | 2210501268 | E452A2A15011S0K |
| 902 | 2210501269 | E452A2A15011S0L |
| 903 | 2210501270 | E452A2A15011S0M |
| 904 | 2210501271 | E452A2A20011000 |
| 905 | 2210501272 | E452A2A20011A11 |
| 906 | 2210501273 | E452A2A20011A12 |
| 907 | 2210501274 | E452A2A20011A13 |
| 908 | 2210501275 | E452A2A20011A14 |
| 909 | 2210501276 | E452A2A20011A15 |
| 910 | 2210501277 | E452A2A20011A1A |
| 911 | 2210501278 | E452A2A20011A1B |
| 912 | 2210501279 | E452A2A20011A1C |
| 913 | 2210501280 | E452A2A20011A1D |
| 914 | 2210501281 | E452A2A20011A1E |
| 915 | 2210501282 | E452A2A20011A1G |
| 916 | 2210501283 | E452A2A20011A1H |
| 917 | 2210501284 | E452A2A20011A1K |
| 918 | 2210501285 | E452A2A20011A1L |
| 919 | 2210501286 | E452A2A20011A1M |
| 920 | 2210501287 | E452A2A20011C31 |

| Pos. | Molex PN: | Engineering No.: |
|------|------------|------------------|
| 921 | 2210501288 | E452A2A20011C32 |
| 922 | 2210501289 | E452A2A20011C33 |
| 923 | 2210501290 | E452A2A20011C34 |
| 924 | 2210501291 | E452A2A20011C35 |
| 925 | 2210501292 | E452A2A20011C3A |
| 926 | 2210501293 | E452A2A20011C3B |
| 927 | 2210501294 | E452A2A20011C3C |
| 928 | 2210501295 | E452A2A20011C3D |
| 929 | 2210501296 | E452A2A20011C3E |
| 930 | 2210501297 | E452A2A20011C3G |
| 931 | 2210501298 | E452A2A20011C3H |
| 932 | 2210501299 | E452A2A20011C3K |
| 933 | 2210501300 | E452A2A20011C3L |
| 934 | 2210501301 | E452A2A20011C3M |
| 935 | 2210501302 | E452A2A20011C41 |
| 936 | 2210501303 | E452A2A20011C42 |
| 937 | 2210501304 | E452A2A20011C43 |
| 938 | 2210501305 | E452A2A20011C44 |
| 939 | 2210501306 | E452A2A20011C45 |
| 940 | 2210501307 | E452A2A20011C4A |
| 941 | 2210501308 | E452A2A20011C4B |
| 942 | 2210501309 | E452A2A20011C4C |
| 943 | 2210501310 | E452A2A20011C4D |
| 944 | 2210501311 | E452A2A20011C4E |
| 945 | 2210501312 | E452A2A20011C4G |
| 946 | 2210501313 | E452A2A20011C4K |
| 947 | 2210501314 | E452A2A20011C4L |
| 948 | 2210501315 | E452A2A20011C4M |
| 949 | 2210501320 | E452A2A20011E05 |
| 950 | N/A | N/A |
| 951 | N/A | N/A |
| 952 | N/A | N/A |
| 953 | N/A | N/A |
| 954 | 2210501335 | E452A2A20011R05 |
| 955 | N/A | N/A |
| 956 | N/A | N/A |
| 957 | N/A | N/A |
| 958 | N/A | N/A |
| 959 | N/A | N/A |
| 960 | N/A | N/A |

| Pos. | Molex PN: | Engineering No.: |
|------|------------|------------------|
| 961 | N/A | N/A |
| 962 | N/A | N/A |
| 963 | N/A | N/A |
| 964 | N/A | N/A |
| 965 | 2210501346 | E452A2A20011R21 |
| 966 | 2210501347 | E452A2A20011R22 |
| 967 | 2210501348 | E452A2A20011R23 |
| 968 | 2210501349 | E452A2A20011R24 |
| 969 | 2210501350 | E452A2A20011R25 |
| 970 | 2210501351 | E452A2A20011R2A |
| 971 | 2210501352 | E452A2A20011R2B |
| 972 | 2210501353 | E452A2A20011R2C |
| 973 | 2210501354 | E452A2A20011R2D |
| 974 | 2210501355 | E452A2A20011R2E |
| 975 | 2210501356 | E452A2A20011R2G |
| 976 | 2210501357 | E452A2A20011R2H |
| 977 | 2210501358 | E452A2A20011R2K |
| 978 | 2210501359 | E452A2A20011R2L |
| 979 | 2210501360 | E452A2A20011R2M |
| 980 | 2210501361 | E452A2A20011S01 |
| 981 | 2210501362 | E452A2A20011S02 |
| 982 | 2210501363 | E452A2A20011S03 |
| 983 | 2210501364 | E452A2A20011S04 |
| 984 | 2210501365 | E452A2A20011S05 |
| 985 | 2210501366 | E452A2A20011S0A |
| 986 | 2210501367 | E452A2A20011S0B |
| 987 | 2210501368 | E452A2A20011S0C |
| 988 | 2210501369 | E452A2A20011S0D |
| 989 | 2210501370 | E452A2A20011S0E |
| 990 | 2210501371 | E452A2A20011S0G |
| 991 | 2210501372 | E452A2A20011S0K |
| 992 | 2210501373 | E452A2A20011S0L |
| 993 | 2210501374 | E452A2A20011S0M |
| 994 | 2210501375 | E452A2A30011000 |
| 995 | 2210501376 | E452A2A30011A11 |
| 996 | 2210501377 | E452A2A30011A12 |
| 997 | 2210501378 | E452A2A30011A13 |
| 998 | 2210501379 | E452A2A30011A14 |
| 999 | 2210501380 | E452A2A30011A15 |
| 1000 | 2210501381 | E452A2A30011A1A |

| | | | | | | | | | |
|---|--|-------|--|---|--|------------------------|--|---|--|
| THIS DRAWING CONTAINS INFORMATION THAT IS PROPRIETARY TO MOLEX ELECTRONIC TECHNOLOGIES, LLC AND SHOULD NOT BE USED WITHOUT WRITTEN PERMISSION | | | | | | | | | |
| DIMENSION UNITS | | SCALE | | CURRENT REV DESC: REVISION CREATED FOR REMOVING PRE-RELEASE STAMP | | | |  E452XXXXXXXXXX DIN FORM A EN 175301-803 | |
| mm | | NTS | | | | | | | |
| GENERAL TOLERANCES (UNLESS SPECIFIED) | | | | EC NO: 714567 | | 2022/07/18 | | PRODUCT CUSTOMER DRAWING | |
| | | | | DRWN: SUGEEB | | 2022/07/19 | | | |
| | | | | CHK'D: GGA | | 2022/07/19 | | DOCUMENT NUMBER | |
| | | | | APPR: GGA | | 2022/07/19 | | | |
| | | | | INITIAL REVISION: | | | | SD-121050-001 | |
| | | | | DRWN: JMARSZALEK | | 2012/08/27 | | | |
| | | | | APPR: MDYSZEWSKA | | 2012/08/20 | | DOC TYPE | |
| | | | | ANGULAR TOL | | | | DOC PART | |
| | | | | DRAFT WHERE APPLICABLE | | FIRST ANGLE PROJECTION | | REVISION | |
| | | | | MUST REMAIN WITHIN DIMENSIONS | | DRAWING | | SERIES | |
| | | | | | | A3-SIZE | | MATERIAL NUMBER | |
| | | | | | | 121050 | | CUSTOMER | |
| | | | | | | SEE TABLE | | SHEET NUMBER | |
| | | | | | | GENERAL MARKET | | 9 OF 41 | |

TABLE 3 - PART LIST

| Pos. | Molex PN: | Engineering No.: |
|------|------------|------------------|
| 1001 | 2210501382 | E452A2A30011A1B |
| 1002 | 2210501383 | E452A2A30011A1C |
| 1003 | 2210501384 | E452A2A30011A1D |
| 1004 | 2210501385 | E452A2A30011A1E |
| 1005 | 2210501386 | E452A2A30011A1G |
| 1006 | 2210501387 | E452A2A30011A1H |
| 1007 | 2210501388 | E452A2A30011A1K |
| 1008 | 2210501389 | E452A2A30011A1L |
| 1009 | 2210501390 | E452A2A30011A1M |
| 1010 | 2210501391 | E452A2A30011C31 |
| 1011 | 2210501392 | E452A2A30011C33 |
| 1012 | 2210501393 | E452A2A30011C34 |
| 1013 | 2210501394 | E452A2A30011C35 |
| 1014 | 2210501395 | E452A2A30011C3A |
| 1015 | 2210501396 | E452A2A30011C3B |
| 1016 | 2210501397 | E452A2A30011C3C |
| 1017 | 2210501398 | E452A2A30011C3D |
| 1018 | 2210501399 | E452A2A30011C3E |
| 1019 | 2210501400 | E452A2A30011C3G |
| 1020 | 2210501401 | E452A2A30011C3H |
| 1021 | 2210501402 | E452A2A30011C3K |
| 1022 | 2210501403 | E452A2A30011C3L |
| 1023 | 2210501404 | E452A2A30011C3M |
| 1024 | 2210501405 | E452A2A30011C41 |
| 1025 | 2210501406 | E452A2A30011C42 |
| 1026 | 2210501407 | E452A2A30011C43 |
| 1027 | 2210501408 | E452A2A30011C44 |
| 1028 | 2210501409 | E452A2A30011C45 |
| 1029 | 2210501410 | E452A2A30011C4A |
| 1030 | 2210501411 | E452A2A30011C4B |
| 1031 | 2210501412 | E452A2A30011C4C |
| 1032 | 2210501413 | E452A2A30011C4D |
| 1033 | 2210501414 | E452A2A30011C4E |
| 1034 | 2210501415 | E452A2A30011C4G |
| 1035 | 2210501416 | E452A2A30011C4K |
| 1036 | 2210501417 | E452A2A30011C4L |
| 1037 | 2210501418 | E452A2A30011C4M |
| 1038 | 2210501423 | E452A2A30011E05 |
| 1039 | N/A | N/A |
| 1040 | N/A | N/A |

| Pos. | Molex PN: | Engineering No.: |
|------|------------|------------------|
| 1041 | N/A | N/A |
| 1042 | N/A | N/A |
| 1043 | 2210501438 | E452A2A30011R05 |
| 1044 | N/A | N/A |
| 1045 | N/A | N/A |
| 1046 | N/A | N/A |
| 1047 | N/A | N/A |
| 1048 | N/A | N/A |
| 1049 | N/A | N/A |
| 1050 | N/A | N/A |
| 1051 | N/A | N/A |
| 1052 | N/A | N/A |
| 1053 | N/A | N/A |
| 1054 | 2210501449 | E452A2A30011R21 |
| 1055 | 2210501450 | E452A2A30011R22 |
| 1056 | 2210501451 | E452A2A30011R23 |
| 1057 | 2210501452 | E452A2A30011R24 |
| 1058 | 2210501453 | E452A2A30011R25 |
| 1059 | 2210501454 | E452A2A30011R2A |
| 1060 | 2210501455 | E452A2A30011R2B |
| 1061 | 2210501456 | E452A2A30011R2C |
| 1062 | 2210501457 | E452A2A30011R2D |
| 1063 | 2210501458 | E452A2A30011R2E |
| 1064 | 2210501459 | E452A2A30011R2G |
| 1065 | 2210501460 | E452A2A30011R2H |
| 1066 | 2210501461 | E452A2A30011R2K |
| 1067 | 2210501462 | E452A2A30011R2L |
| 1068 | 2210501463 | E452A2A30011R2M |
| 1069 | 2210501464 | E452A2A30011S01 |
| 1070 | 2210501465 | E452A2A30011S02 |
| 1071 | 2210501466 | E452A2A30011S03 |
| 1072 | 2210501467 | E452A2A30011S04 |
| 1073 | 2210501468 | E452A2A30011S05 |
| 1074 | 2210501469 | E452A2A30011S0A |
| 1075 | 2210501470 | E452A2A30011S0B |
| 1076 | 2210501471 | E452A2A30011S0C |
| 1077 | 2210501472 | E452A2A30011S0D |
| 1078 | 2210501473 | E452A2A30011S0E |
| 1079 | 2210501474 | E452A2A30011S0G |
| 1080 | 2210501475 | E452A2A30011S0K |

| Pos. | Molex PN: | Engineering No.: |
|------|------------|------------------|
| 1081 | 2210501476 | E452A2A30011S0L |
| 1082 | 2210501477 | E452A2A30011S0M |
| 1083 | 2210501478 | E452A2A50011000 |
| 1084 | 2210501479 | E452A2A50011A11 |
| 1085 | 2210501480 | E452A2A50011A12 |
| 1086 | 2210501481 | E452A2A50011A13 |
| 1087 | 2210501482 | E452A2A50011A14 |
| 1088 | 2210501483 | E452A2A50011A15 |
| 1089 | 2210501484 | E452A2A50011A1A |
| 1090 | 2210501485 | E452A2A50011A1B |
| 1091 | 2210501486 | E452A2A50011A1C |
| 1092 | 2210501487 | E452A2A50011A1D |
| 1093 | 2210501488 | E452A2A50011A1E |
| 1094 | 2210501489 | E452A2A50011A1G |
| 1095 | 2210501490 | E452A2A50011A1H |
| 1096 | 2210501491 | E452A2A50011A1K |
| 1097 | 2210501492 | E452A2A50011A1L |
| 1098 | 2210501493 | E452A2A50011A1M |
| 1099 | 2210501494 | E452A2A50011C31 |
| 1100 | 2210501495 | E452A2A50011C32 |
| 1101 | 2210501496 | E452A2A50011C33 |
| 1102 | 2210501497 | E452A2A50011C34 |
| 1103 | 2210501498 | E452A2A50011C35 |
| 1104 | 2210501499 | E452A2A50011C3A |
| 1105 | 2210501500 | E452A2A50011C3B |
| 1106 | 2210501501 | E452A2A50011C3C |
| 1107 | 2210501502 | E452A2A50011C3D |
| 1108 | 2210501503 | E452A2A50011C3E |
| 1109 | 2210501504 | E452A2A50011C3G |
| 1110 | 2210501505 | E452A2A50011C3H |
| 1111 | 2210501506 | E452A2A50011C3K |
| 1112 | 2210501507 | E452A2A50011C3L |
| 1113 | 2210501508 | E452A2A50011C3M |
| 1114 | 2210501509 | E452A2A50011C41 |
| 1115 | 2210501510 | E452A2A50011C42 |
| 1116 | 2210501511 | E452A2A50011C43 |
| 1117 | 2210501512 | E452A2A50011C44 |
| 1118 | 2210501513 | E452A2A50011C45 |
| 1119 | 2210501514 | E452A2A50011C4A |
| 1120 | 2210501515 | E452A2A50011C4B |

| Pos. | Molex PN: | Engineering No.: |
|------|------------|------------------|
| 1121 | 2210501516 | E452A2A50011C4C |
| 1122 | 2210501517 | E452A2A50011C4D |
| 1123 | 2210501518 | E452A2A50011C4E |
| 1124 | 2210501519 | E452A2A50011C4G |
| 1125 | 2210501520 | E452A2A50011C4H |
| 1126 | 2210501521 | E452A2A50011C4K |
| 1127 | 2210501522 | E452A2A50011C4L |
| 1128 | 2210501523 | E452A2A50011C4M |
| 1129 | 2210501528 | E452A2A50011E05 |
| 1130 | N/A | N/A |
| 1131 | N/A | N/A |
| 1132 | N/A | N/A |
| 1133 | N/A | N/A |
| 1134 | 2210501543 | E452A2A50011R05 |
| 1135 | N/A | N/A |
| 1136 | N/A | N/A |
| 1137 | N/A | N/A |
| 1138 | N/A | N/A |
| 1139 | N/A | N/A |
| 1140 | N/A | N/A |
| 1141 | N/A | N/A |
| 1142 | N/A | N/A |
| 1143 | N/A | N/A |
| 1144 | N/A | N/A |
| 1145 | 2210501554 | E452A2A50011R21 |
| 1146 | 2210501555 | E452A2A50011R22 |
| 1147 | 2210501556 | E452A2A50011R23 |
| 1148 | 2210501557 | E452A2A50011R24 |
| 1149 | 2210501558 | E452A2A50011R25 |
| 1150 | 2210501559 | E452A2A50011R2A |
| 1151 | 2210501560 | E452A2A50011R2B |
| 1152 | 2210501561 | E452A2A50011R2C |
| 1153 | 2210501562 | E452A2A50011R2D |
| 1154 | 2210501563 | E452A2A50011R2E |
| 1155 | 2210501564 | E452A2A50011R2G |
| 1156 | 2210501565 | E452A2A50011R2H |
| 1157 | 2210501566 | E452A2A50011R2K |
| 1158 | 2210501567 | E452A2A50011R2L |
| 1159 | 2210501568 | E452A2A50011R2M |
| 1160 | 2210501569 | E452A2A50011S01 |

| | | | | | | | |
|---|---|-----------------|------|---|--|---|--|
| THIS DRAWING CONTAINS INFORMATION THAT IS PROPRIETARY TO MOLEX ELECTRONIC TECHNOLOGIES, LLC AND SHOULD NOT BE USED WITHOUT WRITTEN PERMISSION | | | | | | | |
| DIMENSION UNITS | | SCALE | | CURRENT REV DESC: REVISION CREATED FOR REMOVING PRE-RELEASE STAMP | |  | |
| mm | | NTS | | | | E452XXXXXXXXXX DIN FORM A EN 175301-803 | |
| GENERAL TOLERANCES (UNLESS SPECIFIED) | | | | | | | |
| | | MM | INCH | | | | |
| 4 PLACES | ± | | | | | | |
| 3 PLACES | ± | | | | | | |
| 2 PLACES | ± | | | | | | |
| 1 PLACE | ± | | | | | | |
| 0 PLACES | ± | | | | | | |
| ANGULAR TOL | ± | ° | | | | | |
| DRAFT WHERE APPLICABLE MUST REMAIN WITHIN DIMENSIONS | | | | FIRST ANGLE PROJECTION | | DRAWING | |
| | | | |  | | A3-SIZE | |
| SERIES | | MATERIAL NUMBER | | CUSTOMER | | SHEET NUMBER | |
| 121050 | | SEE TABLE | | GENERAL MARKET | | 10 OF 41 | |

TABLE 3 - PART LIST

| Pos. | Molex PN: | Engineering No.: |
|------|------------|------------------|
| 1161 | 2210501570 | E452A2A50011S02 |
| 1162 | 2210501571 | E452A2A50011S03 |
| 1163 | 2210501572 | E452A2A50011S04 |
| 1164 | 2210501573 | E452A2A50011S05 |
| 1165 | 2210501574 | E452A2A50011S0A |
| 1166 | 2210501575 | E452A2A50011S0B |
| 1167 | 2210501576 | E452A2A50011S0C |
| 1168 | 2210501577 | E452A2A50011S0D |
| 1169 | 2210501578 | E452A2A50011S0E |
| 1170 | 2210501579 | E452A2A50011S0G |
| 1171 | 2210501580 | E452A2A50011S0K |
| 1172 | 2210501581 | E452A2A50011S0L |
| 1173 | 2210501582 | E452A2A50011S0M |
| 1174 | 2210501583 | E452A3A10011000 |
| 1175 | 2210501584 | E452A3A10011A11 |
| 1176 | 2210501585 | E452A3A10011A12 |
| 1177 | 2210501586 | E452A3A10011A13 |
| 1178 | 2210501587 | E452A3A10011A14 |
| 1179 | 2210501588 | E452A3A10011A15 |
| 1180 | 2210501589 | E452A3A10011A1A |
| 1181 | 2210501590 | E452A3A10011A1B |
| 1182 | 2210501591 | E452A3A10011A1C |
| 1183 | 2210501592 | E452A3A10011A1D |
| 1184 | 2210501593 | E452A3A10011A1E |
| 1185 | 2210501594 | E452A3A10011A1G |
| 1186 | 2210501595 | E452A3A10011A1H |
| 1187 | 2210501596 | E452A3A10011A1K |
| 1188 | 2210501597 | E452A3A10011A1L |
| 1189 | 2210501598 | E452A3A10011A1M |
| 1190 | 2210501599 | E452A3A10011C31 |
| 1191 | 2210501600 | E452A3A10011C32 |
| 1192 | 2210501601 | E452A3A10011C33 |
| 1193 | 2210501602 | E452A3A10011C34 |
| 1194 | 2210501603 | E452A3A10011C35 |
| 1195 | 2210501604 | E452A3A10011C3A |
| 1196 | 2210501605 | E452A3A10011C3B |
| 1197 | 2210501606 | E452A3A10011C3C |
| 1198 | 2210501607 | E452A3A10011C3D |
| 1199 | 2210501608 | E452A3A10011C3E |
| 1200 | 2210501609 | E452A3A10011C3G |

| Pos. | Molex PN: | Engineering No.: |
|------|------------|------------------|
| 1201 | 2210501610 | E452A3A10011C3H |
| 1202 | 2210501611 | E452A3A10011C3K |
| 1203 | 2210501612 | E452A3A10011C3L |
| 1204 | 2210501613 | E452A3A10011C3M |
| 1205 | 2210501614 | E452A3A10011C41 |
| 1206 | 2210501615 | E452A3A10011C43 |
| 1207 | 2210501616 | E452A3A10011C44 |
| 1208 | 2210501617 | E452A3A10011C45 |
| 1209 | 2210501618 | E452A3A10011C4A |
| 1210 | 2210501619 | E452A3A10011C4B |
| 1211 | 2210501620 | E452A3A10011C4C |
| 1212 | 2210501621 | E452A3A10011C4D |
| 1213 | 2210501622 | E452A3A10011C4E |
| 1214 | 2210501623 | E452A3A10011C4G |
| 1215 | 2210501624 | E452A3A10011C4H |
| 1216 | 2210501625 | E452A3A10011C4K |
| 1217 | 2210501626 | E452A3A10011C4L |
| 1218 | 2210501627 | E452A3A10011C4M |
| 1219 | 2210501632 | E452A3A10011E05 |
| 1220 | N/A | N/A |
| 1221 | N/A | N/A |
| 1222 | N/A | N/A |
| 1223 | N/A | N/A |
| 1224 | 2210501647 | E452A3A10011R05 |
| 1225 | N/A | N/A |
| 1226 | N/A | N/A |
| 1227 | N/A | N/A |
| 1228 | N/A | N/A |
| 1229 | N/A | N/A |
| 1230 | N/A | N/A |
| 1231 | N/A | N/A |
| 1232 | N/A | N/A |
| 1233 | N/A | N/A |
| 1234 | N/A | N/A |
| 1235 | 2210501658 | E452A3A10011R21 |
| 1236 | 2210501659 | E452A3A10011R22 |
| 1237 | 2210501660 | E452A3A10011R23 |
| 1238 | 2210501661 | E452A3A10011R24 |
| 1239 | 2210501662 | E452A3A10011R25 |
| 1240 | 2210501663 | E452A3A10011R2A |

| Pos. | Molex PN: | Engineering No.: |
|------|------------|------------------|
| 1241 | 2210501664 | E452A3A10011R2B |
| 1242 | 2210501665 | E452A3A10011R2C |
| 1243 | 2210501666 | E452A3A10011R2D |
| 1244 | 2210501667 | E452A3A10011R2E |
| 1245 | 2210501668 | E452A3A10011R2G |
| 1246 | 2210501669 | E452A3A10011R2H |
| 1247 | 2210501670 | E452A3A10011R2K |
| 1248 | 2210501671 | E452A3A10011R2L |
| 1249 | 2210501672 | E452A3A10011R2M |
| 1250 | 2210501673 | E452A3A10011S01 |
| 1251 | 2210501674 | E452A3A10011S02 |
| 1252 | 2210501675 | E452A3A10011S03 |
| 1253 | 2210501676 | E452A3A10011S04 |
| 1254 | 2210501677 | E452A3A10011S05 |
| 1255 | 2210501678 | E452A3A10011S0A |
| 1256 | 2210501679 | E452A3A10011S0B |
| 1257 | 2210501680 | E452A3A10011S0C |
| 1258 | 2210501681 | E452A3A10011S0D |
| 1259 | 2210501682 | E452A3A10011S0E |
| 1260 | 2210501683 | E452A3A10011S0G |
| 1261 | 2210501684 | E452A3A10011S0H |
| 1262 | 2210501685 | E452A3A10011S0K |
| 1263 | 2210501686 | E452A3A10011S0L |
| 1264 | 2210501687 | E452A3A10011S0M |
| 1265 | 2210501688 | E452A3A10K11000 |
| 1266 | 2210501689 | E452A3A10K11A11 |
| 1267 | 2210501690 | E452A3A10K11A12 |
| 1268 | 2210501691 | E452A3A10K11A13 |
| 1269 | 2210501692 | E452A3A10K11A14 |
| 1270 | 2210501693 | E452A3A10K11A15 |
| 1271 | 2210501694 | E452A3A10K11A1A |
| 1272 | 2210501695 | E452A3A10K11A1B |
| 1273 | 2210501696 | E452A3A10K11A1C |
| 1274 | 2210501697 | E452A3A10K11A1D |
| 1275 | 2210501698 | E452A3A10K11A1E |
| 1276 | 2210501699 | E452A3A10K11A1G |
| 1277 | 2210501700 | E452A3A10K11A1H |
| 1278 | 2210501701 | E452A3A10K11A1K |
| 1279 | 2210501702 | E452A3A10K11A1L |
| 1280 | 2210501703 | E452A3A10K11A1M |

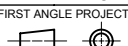
| Pos. | Molex PN: | Engineering No.: |
|------|------------|------------------|
| 1281 | 2210501704 | E452A3A10K11C31 |
| 1282 | 2210501705 | E452A3A10K11C32 |
| 1283 | 2210501706 | E452A3A10K11C33 |
| 1284 | 2210501707 | E452A3A10K11C34 |
| 1285 | 2210501708 | E452A3A10K11C35 |
| 1286 | 2210501709 | E452A3A10K11C3A |
| 1287 | 2210501710 | E452A3A10K11C3B |
| 1288 | 2210501711 | E452A3A10K11C3C |
| 1289 | 2210501712 | E452A3A10K11C3D |
| 1290 | 2210501713 | E452A3A10K11C3E |
| 1291 | 2210501714 | E452A3A10K11C3G |
| 1292 | 2210501715 | E452A3A10K11C3H |
| 1293 | 2210501716 | E452A3A10K11C3K |
| 1294 | 2210501717 | E452A3A10K11C3L |
| 1295 | 2210501718 | E452A3A10K11C3M |
| 1296 | 2210501719 | E452A3A10K11C41 |
| 1297 | 2210501720 | E452A3A10K11C42 |
| 1298 | 2210501721 | E452A3A10K11C43 |
| 1299 | 2210501722 | E452A3A10K11C44 |
| 1300 | 2210501723 | E452A3A10K11C45 |
| 1301 | 2210501724 | E452A3A10K11C4A |
| 1302 | 2210501725 | E452A3A10K11C4B |
| 1303 | 2210501726 | E452A3A10K11C4C |
| 1304 | 2210501727 | E452A3A10K11C4D |
| 1305 | 2210501728 | E452A3A10K11C4E |
| 1306 | 2210501729 | E452A3A10K11C4G |
| 1307 | 2210501730 | E452A3A10K11C4H |
| 1308 | 2210501731 | E452A3A10K11C4K |
| 1309 | 2210501732 | E452A3A10K11C4L |
| 1310 | 2210501733 | E452A3A10K11C4M |
| 1311 | 2210501738 | E452A3A10K11E05 |
| 1312 | N/A | N/A |
| 1313 | N/A | N/A |
| 1314 | N/A | N/A |
| 1315 | N/A | N/A |
| 1316 | 2210501753 | E452A3A10K11R05 |
| 1317 | N/A | N/A |
| 1318 | N/A | N/A |
| 1319 | N/A | N/A |
| 1320 | N/A | N/A |

| | | | | | | | |
|---|--|---------------------------------------|--|---|--|---|--|
| THIS DRAWING CONTAINS INFORMATION THAT IS PROPRIETARY TO MOLEX ELECTRONIC TECHNOLOGIES, LLC AND SHOULD NOT BE USED WITHOUT WRITTEN PERMISSION | | SCALE mm NTS | | CURRENT REV DESC: REVISION CREATED FOR REMOVING PRE-RELEASE STAMP | |  E452XXXXXXXXXX DIN FORM A EN 175301-803 | |
| DIMENSION UNITS | | GENERAL TOLERANCES (UNLESS SPECIFIED) | | EC NO: 714567 DRWN: SUGEEB 2022/07/18 CHK'D: GGA 2022/07/19 APPR: GGA 2022/07/19 | | | |
| 4 PLACES ± | | MM INCH | | INITIAL REVISION: | | DOCUMENT NUMBER | |
| 3 PLACES ± | | | | DRWN: JMARSZALEK 2012/08/27 | | SD-121050-001 | |
| 2 PLACES ± | | | | APPR: MDYSZEWSKA 2012/08/20 | | DOC TYPE DOC PART REVISION PSD 001 E1 | |
| 1 PLACE ± | | | | DRAFT WHERE APPLICABLE MUST REMAIN WITHIN DIMENSIONS | | SHEET NUMBER 11 OF 41 | |
| 0 PLACES ± | | | | FIRST ANGLE PROJECTION | | MATERIAL NUMBER CUSTOMER SEE TABLE GENERAL MARKET | |
| ANGULAR TOL ± ° | | | | DRAWING SERIES A3-SIZE 121050 | | | |

TABLE 3 - PART LIST

| Pos. | Molex PN: | Engineering No.: |
|------|------------|------------------|
| 1321 | N/A | N/A |
| 1322 | N/A | N/A |
| 1323 | N/A | N/A |
| 1324 | N/A | N/A |
| 1325 | N/A | N/A |
| 1326 | N/A | N/A |
| 1327 | 2210501764 | E452A3A10K11R21 |
| 1328 | 2210501765 | E452A3A10K11R22 |
| 1329 | 2210501766 | E452A3A10K11R23 |
| 1330 | 2210501767 | E452A3A10K11R24 |
| 1331 | 2210501768 | E452A3A10K11R25 |
| 1332 | 2210501769 | E452A3A10K11R2A |
| 1333 | 2210501770 | E452A3A10K11R2B |
| 1334 | 2210501771 | E452A3A10K11R2C |
| 1335 | 2210501772 | E452A3A10K11R2D |
| 1336 | 2210501773 | E452A3A10K11R2E |
| 1337 | 2210501774 | E452A3A10K11R2G |
| 1338 | 2210501775 | E452A3A10K11R2H |
| 1339 | 2210501776 | E452A3A10K11R2K |
| 1340 | 2210501777 | E452A3A10K11R2L |
| 1341 | 2210501778 | E452A3A10K11R2M |
| 1342 | 2210501779 | E452A3A10K11S01 |
| 1343 | 2210501780 | E452A3A10K11S02 |
| 1344 | 2210501781 | E452A3A10K11S03 |
| 1345 | 2210501782 | E452A3A10K11S04 |
| 1346 | 2210501783 | E452A3A10K11S05 |
| 1347 | 2210501784 | E452A3A10K11S0A |
| 1348 | 2210501785 | E452A3A10K11S0B |
| 1349 | 2210501786 | E452A3A10K11S0C |
| 1350 | 2210501787 | E452A3A10K11S0D |
| 1351 | 2210501788 | E452A3A10K11S0E |
| 1352 | 2210501789 | E452A3A10K11S0G |
| 1353 | 2210501790 | E452A3A10K11S0K |
| 1354 | 2210501791 | E452A3A10K11S0L |
| 1355 | 2210501792 | E452A3A10K11S0M |
| 1356 | 2210501793 | E452A3A15011000 |
| 1357 | 2210501794 | E452A3A15011A11 |
| 1358 | 2210501795 | E452A3A15011A12 |
| 1359 | 2210501796 | E452A3A15011A13 |
| 1360 | 2210501797 | E452A3A15011A14 |

| Pos. | Molex PN: | Engineering No.: |
|------|------------|------------------|
| 1361 | 2210501798 | E452A3A15011A15 |
| 1362 | 2210501799 | E452A3A15011A1A |
| 1363 | 2210501800 | E452A3A15011A1B |
| 1364 | 2210501801 | E452A3A15011A1C |
| 1365 | 2210501802 | E452A3A15011A1D |
| 1366 | 2210501803 | E452A3A15011A1E |
| 1367 | 2210501804 | E452A3A15011A1G |
| 1368 | 2210501805 | E452A3A15011A1H |
| 1369 | 2210501806 | E452A3A15011A1K |
| 1370 | 2210501807 | E452A3A15011A1L |
| 1371 | 2210501808 | E452A3A15011A1M |
| 1372 | 2210501809 | E452A3A15011C31 |
| 1373 | 2210501810 | E452A3A15011C32 |
| 1374 | 2210501811 | E452A3A15011C33 |
| 1375 | 2210501812 | E452A3A15011C34 |
| 1376 | 2210501813 | E452A3A15011C35 |
| 1377 | 2210501814 | E452A3A15011C3A |
| 1378 | 2210501815 | E452A3A15011C3B |
| 1379 | 2210501816 | E452A3A15011C3C |
| 1380 | 2210501817 | E452A3A15011C3D |
| 1381 | 2210501818 | E452A3A15011C3E |
| 1382 | 2210501819 | E452A3A15011C3G |
| 1383 | 2210501820 | E452A3A15011C3H |
| 1384 | 2210501821 | E452A3A15011C3K |
| 1385 | 2210501822 | E452A3A15011C3L |
| 1386 | 2210501823 | E452A3A15011C3M |
| 1387 | 2210501824 | E452A3A15011C41 |
| 1388 | 2210501825 | E452A3A15011C42 |
| 1389 | 2210501826 | E452A3A15011C43 |
| 1390 | 2210501827 | E452A3A15011C44 |
| 1391 | 2210501828 | E452A3A15011C45 |
| 1392 | 2210501829 | E452A3A15011C4A |
| 1393 | 2210501830 | E452A3A15011C4B |
| 1394 | 2210501831 | E452A3A15011C4C |
| 1395 | 2210501832 | E452A3A15011C4D |
| 1396 | 2210501833 | E452A3A15011C4E |
| 1397 | 2210501834 | E452A3A15011C4G |
| 1398 | 2210501835 | E452A3A15011C4H |
| 1399 | 2210501836 | E452A3A15011C4K |
| 1400 | 2210501837 | E452A3A15011C4L |

| Pos. | Molex PN: | Engineering No.: |
|------|------------|------------------|
| 1401 | 2210501838 | E452A3A15011C4M |
| 1402 | 2210501843 | E452A3A15011E05 |
| 1403 | N/A | N/A |
| 1404 | N/A | N/A |
| 1405 | N/A | N/A |
| 1406 | N/A | N/A |
| 1407 | 2210501858 | E452A3A15011R05 |
| 1408 | N/A | N/A |
| 1409 | N/A | N/A |
| 1410 | N/A | N/A |
| 1411 | N/A | N/A |
| 1412 | N/A | N/A |
| 1413 | N/A | N/A |
| 1414 | N/A | N/A |
| 1415 | N/A | N/A |
| 1416 | N/A | N/A |
| 1417 | N/A | N/A |
| 1418 | 2210501869 | E452A3A15011R21 |
| 1419 | 2210501870 | E452A3A15011R22 |
| 1420 | 2210501871 | E452A3A15011R23 |
| 1421 | 2210501872 | E452A3A15011R24 |
| 1422 | 2210501873 | E452A3A15011R25 |
| 1423 | 2210501874 | E452A3A15011R2A |
| 1424 | 2210501875 | E452A3A15011R2B |
| 1425 | 2210501876 | E452A3A15011R2C |
| 1426 | 2210501877 | E452A3A15011R2D |
| 1427 | 2210501878 | E452A3A15011R2E |
| 1428 | 2210501879 | E452A3A15011R2G |
| 1429 | 2210501880 | E452A3A15011R2H |
| 1430 | 2210501881 | E452A3A15011R2K |
| 1431 | 2210501882 | E452A3A15011R2L |
| 1432 | 2210501883 | E452A3A15011R2M |
| 1433 | 2210501884 | E452A3A15011S01 |
| 1434 | 2210501885 | E452A3A15011S02 |
| 1435 | 2210501886 | E452A3A15011S03 |
| 1436 | 2210501887 | E452A3A15011S04 |
| 1437 | 2210501888 | E452A3A15011S05 |
| 1438 | 2210501889 | E452A3A15011S0A |
| 1439 | 2210501890 | E452A3A15011S0B |
| 1440 | 2210501891 | E452A3A15011S0C |

| Pos. | Molex PN: | Engineering No.: |
|------|------------|------------------|
| 1441 | 2210501892 | E452A3A15011S0D |
| 1442 | 2210501893 | E452A3A15011S0E |
| 1443 | 2210501894 | E452A3A15011S0G |
| 1444 | 2210501895 | E452A3A15011S0K |
| 1445 | 2210501896 | E452A3A15011S0L |
| 1446 | 2210501897 | E452A3A15011S0M |
| 1447 | 2210501898 | E452A3A20011000 |
| 1448 | 2210501899 | E452A3A20011A11 |
| 1449 | 2210501900 | E452A3A20011A12 |
| 1450 | 2210501901 | E452A3A20011A13 |
| 1451 | 2210501902 | E452A3A20011A14 |
| 1452 | 2210501903 | E452A3A20011A15 |
| 1453 | 2210501904 | E452A3A20011A1A |
| 1454 | 2210501905 | E452A3A20011A1B |
| 1455 | 2210501906 | E452A3A20011A1C |
| 1456 | 2210501907 | E452A3A20011A1D |
| 1457 | 2210501908 | E452A3A20011A1E |
| 1458 | 2210501909 | E452A3A20011A1G |
| 1459 | 2210501910 | E452A3A20011A1H |
| 1460 | 2210501911 | E452A3A20011A1K |
| 1461 | 2210501912 | E452A3A20011A1L |
| 1462 | 2210501913 | E452A3A20011C31 |
| 1463 | 2210501914 | E452A3A20011C32 |
| 1464 | 2210501915 | E452A3A20011C33 |
| 1465 | 2210501916 | E452A3A20011C34 |
| 1466 | 2210501917 | E452A3A20011C35 |
| 1467 | 2210501918 | E452A3A20011C3A |
| 1468 | 2210501919 | E452A3A20011C3B |
| 1469 | 2210501920 | E452A3A20011C3C |
| 1470 | 2210501921 | E452A3A20011C3D |
| 1471 | 2210501922 | E452A3A20011C3E |
| 1472 | 2210501923 | E452A3A20011C3G |
| 1473 | 2210501924 | E452A3A20011C3H |
| 1474 | 2210501925 | E452A3A20011C3K |
| 1475 | 2210501926 | E452A3A20011C3L |
| 1476 | 2210501927 | E452A3A20011C3M |
| 1477 | 2210501928 | E452A3A20011C41 |
| 1478 | 2210501929 | E452A3A20011C43 |
| 1479 | 2210501930 | E452A3A20011C4A |
| 1480 | 2210501931 | E452A3A20011C4B |

| | | | | | | | | | | | |
|---|--|------------------------|--|---|--|--------|--|-----------------|--|--|--|
| THIS DRAWING CONTAINS INFORMATION THAT IS PROPRIETARY TO MOLEX ELECTRONIC TECHNOLOGIES, LLC AND SHOULD NOT BE USED WITHOUT WRITTEN PERMISSION | | | | | | | | | | | |
| DIMENSION UNITS mm | | SCALE NTS | | CURRENT REV DESC: REVISION CREATED FOR REMOVING PRE-RELEASE STAMP | | | | molex | | E452XXXXXXXXXX DIN FORM A EN 175301-803 | |
| GENERAL TOLERANCES (UNLESS SPECIFIED) | | | | | | | | | | | |
| | | MM INCH | | EC NO: 714567 | | | | DOCUMENT NUMBER | | DOC TYPE DOC PART REVISION | |
| 4 PLACES ± | | ± | | DRWN: SUGEEB 2022/07/18 | | | | SD-121050-001 | | PSD 001 E1 | |
| 3 PLACES ± | | ± | | CHK'D: GGA 2022/07/19 | | | | | | | |
| 2 PLACES ± | | ± | | APPR: GGA 2022/07/19 | | | | | | | |
| 1 PLACE ± | | ± | | INITIAL REVISION: | | | | | | | |
| 0 PLACES ± | | ± | | DRWN: JMARSZALEK 2012/08/27 | | | | | | | |
| ANGULAR TOL ± ° | | ± ° | | APPR: MDYSZEWSKA 2012/08/20 | | | | | | | |
| DRAFT WHERE APPLICABLE MUST REMAIN WITHIN DIMENSIONS | | FIRST ANGLE PROJECTION | | DRAWING | | SERIES | | MATERIAL NUMBER | | CUSTOMER | |
| | | | | A3-SIZE | | 121050 | | SEE TABLE | | GENERAL MARKET | |
| | | | | | | | | | | SHEET NUMBER 12 OF 41 | |

TABLE 3 - PART LIST

| Pos. | Molex PN: | Engineering No.: |
|------|------------|------------------|
| 1481 | 2210501932 | E452A3A20011C4C |
| 1482 | 2210501933 | E452A3A20011C4D |
| 1483 | 2210501934 | E452A3A20011C4E |
| 1484 | 2210501935 | E452A3A20011C4G |
| 1485 | 2210501936 | E452A3A20011C4H |
| 1486 | 2210501937 | E452A3A20011C4K |
| 1487 | 2210501938 | E452A3A20011C4L |
| 1488 | 2210501939 | E452A3A20011C4M |
| 1489 | 2210501944 | E452A3A20011E05 |
| 1490 | N/A | N/A |
| 1491 | N/A | N/A |
| 1492 | N/A | N/A |
| 1493 | N/A | N/A |
| 1494 | 2210501959 | E452A3A20011R05 |
| 1495 | N/A | N/A |
| 1496 | N/A | N/A |
| 1497 | N/A | N/A |
| 1498 | N/A | N/A |
| 1499 | N/A | N/A |
| 1500 | N/A | N/A |
| 1501 | N/A | N/A |
| 1502 | N/A | N/A |
| 1503 | N/A | N/A |
| 1504 | N/A | N/A |
| 1505 | 2210501970 | E452A3A20011R21 |
| 1506 | 2210501971 | E452A3A20011R22 |
| 1507 | 2210501972 | E452A3A20011R23 |
| 1508 | 2210501973 | E452A3A20011R24 |
| 1509 | 2210501974 | E452A3A20011R25 |
| 1510 | 2210501975 | E452A3A20011R2A |
| 1511 | 2210501976 | E452A3A20011R2B |
| 1512 | 2210501977 | E452A3A20011R2C |
| 1513 | 2210501978 | E452A3A20011R2D |
| 1514 | 2210501979 | E452A3A20011R2E |
| 1515 | 2210501980 | E452A3A20011R2G |
| 1516 | 2210501981 | E452A3A20011R2H |
| 1517 | 2210501982 | E452A3A20011R2K |
| 1518 | 2210501983 | E452A3A20011R2L |
| 1519 | 2210501984 | E452A3A20011R2M |
| 1520 | 2210501985 | E452A3A20011S01 |

| Pos. | Molex PN: | Engineering No.: |
|------|------------|------------------|
| 1521 | 2210501986 | E452A3A20011S02 |
| 1522 | 2210501987 | E452A3A20011S03 |
| 1523 | 2210501988 | E452A3A20011S04 |
| 1524 | 2210501989 | E452A3A20011S05 |
| 1525 | 2210501990 | E452A3A20011S0A |
| 1526 | 2210501991 | E452A3A20011S0B |
| 1527 | 2210501992 | E452A3A20011S0C |
| 1528 | 2210501993 | E452A3A20011S0D |
| 1529 | 2210501994 | E452A3A20011S0E |
| 1530 | 2210501995 | E452A3A20011S0G |
| 1531 | 2210501996 | E452A3A20011S0H |
| 1532 | 2210501997 | E452A3A20011S0K |
| 1533 | 2210501998 | E452A3A20011S0L |
| 1534 | 2210501999 | E452A3A20011S0M |
| 1535 | 2210502000 | E452A3A30011000 |
| 1536 | 2210502001 | E452A3A30011A11 |
| 1537 | 2210502002 | E452A3A30011A12 |
| 1538 | 2210502003 | E452A3A30011A13 |
| 1539 | 2210502004 | E452A3A30011A14 |
| 1540 | 2210502005 | E452A3A30011A15 |
| 1541 | 2210502006 | E452A3A30011A1A |
| 1542 | 2210502007 | E452A3A30011A1B |
| 1543 | 2210502008 | E452A3A30011A1C |
| 1544 | 2210502009 | E452A3A30011A1D |
| 1545 | 2210502010 | E452A3A30011A1E |
| 1546 | 2210502011 | E452A3A30011A1G |
| 1547 | 2210502012 | E452A3A30011A1H |
| 1548 | 2210502013 | E452A3A30011A1K |
| 1549 | 2210502014 | E452A3A30011A1L |
| 1550 | 2210502015 | E452A3A30011A1M |
| 1551 | 2210502016 | E452A3A30011C31 |
| 1552 | 2210502017 | E452A3A30011C32 |
| 1553 | 2210502018 | E452A3A30011C33 |
| 1554 | 2210502019 | E452A3A30011C34 |
| 1555 | 2210502020 | E452A3A30011C35 |
| 1556 | 2210502021 | E452A3A30011C3A |
| 1557 | 2210502022 | E452A3A30011C3B |
| 1558 | 2210502023 | E452A3A30011C3C |
| 1559 | 2210502024 | E452A3A30011C3D |
| 1560 | 2210502025 | E452A3A30011C3E |

| Pos. | Molex PN: | Engineering No.: |
|------|------------|------------------|
| 1561 | 2210502026 | E452A3A30011C3G |
| 1562 | 2210502027 | E452A3A30011C3H |
| 1563 | 2210502028 | E452A3A30011C3K |
| 1564 | 2210502029 | E452A3A30011C3L |
| 1565 | 2210502030 | E452A3A30011C3M |
| 1566 | 2210502031 | E452A3A30011C41 |
| 1567 | 2210502032 | E452A3A30011C43 |
| 1568 | 2210502033 | E452A3A30011C45 |
| 1569 | 2210502034 | E452A3A30011C4A |
| 1570 | 2210502035 | E452A3A30011C4B |
| 1571 | 2210502036 | E452A3A30011C4C |
| 1572 | 2210502037 | E452A3A30011C4D |
| 1573 | 2210502038 | E452A3A30011C4E |
| 1574 | 2210502039 | E452A3A30011C4G |
| 1575 | 2210502040 | E452A3A30011C4K |
| 1576 | 2210502041 | E452A3A30011C4M |
| 1577 | 2210502046 | E452A3A30011E05 |
| 1578 | N/A | N/A |
| 1579 | N/A | N/A |
| 1580 | N/A | N/A |
| 1581 | N/A | N/A |
| 1582 | 2210502061 | E452A3A30011R05 |
| 1583 | N/A | N/A |
| 1584 | N/A | N/A |
| 1585 | N/A | N/A |
| 1586 | N/A | N/A |
| 1587 | N/A | N/A |
| 1588 | N/A | N/A |
| 1589 | N/A | N/A |
| 1590 | N/A | N/A |
| 1591 | N/A | N/A |
| 1592 | N/A | N/A |
| 1593 | 2210502072 | E452A3A30011R21 |
| 1594 | 2210502073 | E452A3A30011R22 |
| 1595 | 2210502074 | E452A3A30011R23 |
| 1596 | 2210502075 | E452A3A30011R24 |
| 1597 | 2210502076 | E452A3A30011R25 |
| 1598 | 2210502077 | E452A3A30011R2A |
| 1599 | 2210502078 | E452A3A30011R2B |
| 1600 | 2210502079 | E452A3A30011R2C |

| Pos. | Molex PN: | Engineering No.: |
|------|------------|------------------|
| 1601 | 2210502080 | E452A3A30011R2D |
| 1602 | 2210502081 | E452A3A30011R2E |
| 1603 | 2210502082 | E452A3A30011R2G |
| 1604 | 2210502083 | E452A3A30011R2H |
| 1605 | 2210502084 | E452A3A30011R2K |
| 1606 | 2210502085 | E452A3A30011R2M |
| 1607 | 2210502086 | E452A3A30011S01 |
| 1608 | 2210502087 | E452A3A30011S02 |
| 1609 | 2210502088 | E452A3A30011S03 |
| 1610 | 2210502089 | E452A3A30011S04 |
| 1611 | 2210502090 | E452A3A30011S05 |
| 1612 | 2210502091 | E452A3A30011S0A |
| 1613 | 2210502092 | E452A3A30011S0B |
| 1614 | 2210502093 | E452A3A30011S0C |
| 1615 | 2210502094 | E452A3A30011S0D |
| 1616 | 2210502095 | E452A3A30011S0E |
| 1617 | 2210502096 | E452A3A30011S0G |
| 1618 | 2210502097 | E452A3A30011S0K |
| 1619 | 2210502098 | E452A3A30011S0L |
| 1620 | 2210502099 | E452A3A30011S0M |
| 1621 | 2210502100 | E452A3A50011000 |
| 1622 | 2210502101 | E452A3A50011A11 |
| 1623 | 2210502102 | E452A3A50011A12 |
| 1624 | 2210502103 | E452A3A50011A13 |
| 1625 | 2210502104 | E452A3A50011A14 |
| 1626 | 2210502105 | E452A3A50011A15 |
| 1627 | 2210502106 | E452A3A50011A1A |
| 1628 | 2210502107 | E452A3A50011A1B |
| 1629 | 2210502108 | E452A3A50011A1C |
| 1630 | 2210502109 | E452A3A50011A1D |
| 1631 | 2210502110 | E452A3A50011A1E |
| 1632 | 2210502111 | E452A3A50011A1G |
| 1633 | 2210502112 | E452A3A50011A1H |
| 1634 | 2210502113 | E452A3A50011A1K |
| 1635 | 2210502114 | E452A3A50011A1L |
| 1636 | 2210502115 | E452A3A50011A1M |
| 1637 | 2210502116 | E452A3A50011C31 |
| 1638 | 2210502117 | E452A3A50011C32 |
| 1639 | 2210502118 | E452A3A50011C33 |
| 1640 | 2210502119 | E452A3A50011C34 |

| | | | | | | | | | |
|---|--|-------|--|---|--|-----------------|--|---|--|
| THIS DRAWING CONTAINS INFORMATION THAT IS PROPRIETARY TO MOLEX ELECTRONIC TECHNOLOGIES, LLC AND SHOULD NOT BE USED WITHOUT WRITTEN PERMISSION | | | | | | | | | |
| DIMENSION UNITS | | SCALE | | CURRENT REV DESC: REVISION CREATED FOR REMOVING PRE-RELEASE STAMP | | | |  E452XXXXXXXXXX DIN FORM A EN 175301-803 | |
| mm | | NTS | | | | | | | |
| GENERAL TOLERANCES (UNLESS SPECIFIED) | | | | EC NO: 714567 | | 2022/07/18 | | PRODUCT CUSTOMER DRAWING | |
| | | | | DRWN: SUGEEB | | 2022/07/19 | | | |
| | | | | CHK'D: GGA | | 2022/07/19 | | DOCUMENT NUMBER | |
| | | | | APPR: GGA | | 2022/07/19 | | | |
| | | | | INITIAL REVISION: | | | | SD-121050-001 | |
| | | | | DRWN: JMARSZALEK | | 2012/08/27 | | | |
| | | | | APPR: MDYSZEWSKA | | 2012/08/20 | | DOC TYPE | |
| | | | | ANGULAR TOL | | | | PSD | |
| DRAFT WHERE APPLICABLE MUST REMAIN WITHIN DIMENSIONS | | | | FIRST ANGLE PROJECTION | | DRAWING | | DOC PART | |
| | | | |  | | A3-SIZE | | 001 | |
| | | | | SERIES | | MATERIAL NUMBER | | REVISION | |
| | | | | 121050 | | SEE TABLE | | E1 | |
| | | | | CUSTOMER | | SHEET NUMBER | | | |
| | | | | GENERAL MARKET | | 13 OF 41 | | | |

TABLE 3 - PART LIST

| Pos. | Molex PN: | Engineering No.: |
|------|------------|------------------|
| 1641 | 2210502120 | E452A3A50011C35 |
| 1642 | 2210502121 | E452A3A50011C3A |
| 1643 | 2210502122 | E452A3A50011C3B |
| 1644 | 2210502123 | E452A3A50011C3C |
| 1645 | 2210502124 | E452A3A50011C3D |
| 1646 | 2210502125 | E452A3A50011C3E |
| 1647 | 2210502126 | E452A3A50011C3G |
| 1648 | 2210502127 | E452A3A50011C3H |
| 1649 | 2210502128 | E452A3A50011C3K |
| 1650 | 2210502129 | E452A3A50011C3L |
| 1651 | 2210502130 | E452A3A50011C3M |
| 1652 | 2210502131 | E452A3A50011C41 |
| 1653 | 2210502132 | E452A3A50011C42 |
| 1654 | 2210502133 | E452A3A50011C43 |
| 1655 | 2210502134 | E452A3A50011C45 |
| 1656 | 2210502135 | E452A3A50011C4A |
| 1657 | 2210502136 | E452A3A50011C4B |
| 1658 | 2210502137 | E452A3A50011C4C |
| 1659 | 2210502138 | E452A3A50011C4D |
| 1660 | 2210502139 | E452A3A50011C4E |
| 1661 | 2210502140 | E452A3A50011C4G |
| 1662 | 2210502141 | E452A3A50011C4H |
| 1663 | 2210502142 | E452A3A50011C4K |
| 1664 | 2210502143 | E452A3A50011C4L |
| 1665 | 2210502144 | E452A3A50011C4M |
| 1666 | 2210502149 | E452A3A50011E05 |
| 1667 | N/A | N/A |
| 1668 | N/A | N/A |
| 1669 | N/A | N/A |
| 1670 | N/A | N/A |
| 1671 | 2210502164 | E452A3A50011R05 |
| 1672 | N/A | N/A |
| 1673 | N/A | N/A |
| 1674 | N/A | N/A |
| 1675 | N/A | N/A |
| 1676 | N/A | N/A |
| 1677 | N/A | N/A |
| 1678 | N/A | N/A |
| 1679 | N/A | N/A |
| 1680 | N/A | N/A |

| Pos. | Molex PN: | Engineering No.: |
|------|------------|------------------|
| 1681 | N/A | N/A |
| 1682 | 2210502175 | E452A3A50011R21 |
| 1683 | 2210502176 | E452A3A50011R22 |
| 1684 | 2210502177 | E452A3A50011R23 |
| 1685 | 2210502178 | E452A3A50011R24 |
| 1686 | 2210502179 | E452A3A50011R25 |
| 1687 | 2210502180 | E452A3A50011R2A |
| 1688 | 2210502181 | E452A3A50011R2B |
| 1689 | 2210502182 | E452A3A50011R2C |
| 1690 | 2210502183 | E452A3A50011R2D |
| 1691 | 2210502184 | E452A3A50011R2E |
| 1692 | 2210502185 | E452A3A50011R2G |
| 1693 | 2210502186 | E452A3A50011R2H |
| 1694 | 2210502187 | E452A3A50011R2K |
| 1695 | 2210502188 | E452A3A50011R2M |
| 1696 | 2210502189 | E452A3A50011S01 |
| 1697 | 2210502190 | E452A3A50011S02 |
| 1698 | 2210502191 | E452A3A50011S03 |
| 1699 | 2210502192 | E452A3A50011S04 |
| 1700 | 2210502193 | E452A3A50011S05 |
| 1701 | 2210502194 | E452A3A50011S0A |
| 1702 | 2210502195 | E452A3A50011S0B |
| 1703 | 2210502196 | E452A3A50011S0C |
| 1704 | 2210502197 | E452A3A50011S0D |
| 1705 | 2210502198 | E452A3A50011S0E |
| 1706 | 2210502199 | E452A3A50011S0G |
| 1707 | 2210502200 | E452A3A50011S0K |
| 1708 | 2210502201 | E452A3A50011S0L |
| 1709 | 2210502202 | E452A3A50011S0M |
| 1710 | 2210502203 | E452B2A10011000 |
| 1711 | 2210502204 | E452B2A10011A11 |
| 1712 | 2210502205 | E452B2A10011A12 |
| 1713 | 2210502206 | E452B2A10011A13 |
| 1714 | 2210502207 | E452B2A10011A14 |
| 1715 | 2210502208 | E452B2A10011A15 |
| 1716 | 2210502209 | E452B2A10011A1A |
| 1717 | 2210502210 | E452B2A10011A1B |
| 1718 | 2210502211 | E452B2A10011A1C |
| 1719 | 2210502212 | E452B2A10011A1D |
| 1720 | 2210502213 | E452B2A10011A1E |

| Pos. | Molex PN: | Engineering No.: |
|------|------------|------------------|
| 1721 | 2210502214 | E452B2A10011A1G |
| 1722 | 2210502215 | E452B2A10011A1H |
| 1723 | 2210502216 | E452B2A10011A1K |
| 1724 | 2210502217 | E452B2A10011A1L |
| 1725 | 2210502218 | E452B2A10011A1M |
| 1726 | 2210502219 | E452B2A10011C31 |
| 1727 | 2210502220 | E452B2A10011C32 |
| 1728 | 2210502221 | E452B2A10011C33 |
| 1729 | 2210502222 | E452B2A10011C34 |
| 1730 | 2210502223 | E452B2A10011C35 |
| 1731 | 2210502224 | E452B2A10011C3A |
| 1732 | 2210502225 | E452B2A10011C3B |
| 1733 | 2210502226 | E452B2A10011C3C |
| 1734 | 2210502227 | E452B2A10011C3D |
| 1735 | 2210502228 | E452B2A10011C3E |
| 1736 | 2210502229 | E452B2A10011C3G |
| 1737 | 2210502230 | E452B2A10011C3H |
| 1738 | 2210502231 | E452B2A10011C3K |
| 1739 | 2210502232 | E452B2A10011C3L |
| 1740 | 2210502233 | E452B2A10011C3M |
| 1741 | 2210502234 | E452B2A10011C41 |
| 1742 | 2210502235 | E452B2A10011C42 |
| 1743 | 2210502236 | E452B2A10011C43 |
| 1744 | 2210502237 | E452B2A10011C44 |
| 1745 | 2210502238 | E452B2A10011C45 |
| 1746 | 2210502239 | E452B2A10011C4A |
| 1747 | 2210502240 | E452B2A10011C4B |
| 1748 | 2210502241 | E452B2A10011C4C |
| 1749 | 2210502242 | E452B2A10011C4D |
| 1750 | 2210502243 | E452B2A10011C4E |
| 1751 | 2210502244 | E452B2A10011C4G |
| 1752 | 2210502245 | E452B2A10011C4H |
| 1753 | 2210502246 | E452B2A10011C4K |
| 1754 | 2210502247 | E452B2A10011C4L |
| 1755 | 2210502248 | E452B2A10011C4M |
| 1756 | 2210502253 | E452B2A10011E05 |
| 1757 | N/A | N/A |
| 1758 | N/A | N/A |
| 1759 | N/A | N/A |
| 1760 | N/A | N/A |

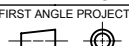
| Pos. | Molex PN: | Engineering No.: |
|------|------------|------------------|
| 1761 | 2210502268 | E452B2A10011R05 |
| 1762 | N/A | N/A |
| 1763 | N/A | N/A |
| 1764 | N/A | N/A |
| 1765 | N/A | N/A |
| 1766 | N/A | N/A |
| 1767 | N/A | N/A |
| 1768 | N/A | N/A |
| 1769 | N/A | N/A |
| 1770 | N/A | N/A |
| 1771 | N/A | N/A |
| 1772 | 2210502279 | E452B2A10011R21 |
| 1773 | 2210502280 | E452B2A10011R22 |
| 1774 | 2210502281 | E452B2A10011R23 |
| 1775 | 2210502282 | E452B2A10011R24 |
| 1776 | 2210502283 | E452B2A10011R25 |
| 1777 | 2210502284 | E452B2A10011R2A |
| 1778 | 2210502285 | E452B2A10011R2B |
| 1779 | 2210502286 | E452B2A10011R2C |
| 1780 | 2210502287 | E452B2A10011R2D |
| 1781 | 2210502288 | E452B2A10011R2E |
| 1782 | 2210502289 | E452B2A10011R2G |
| 1783 | 2210502290 | E452B2A10011R2H |
| 1784 | 2210502291 | E452B2A10011R2K |
| 1785 | 2210502292 | E452B2A10011R2L |
| 1786 | 2210502293 | E452B2A10011R2M |
| 1787 | 2210502294 | E452B2A10011S01 |
| 1788 | 2210502295 | E452B2A10011S02 |
| 1789 | 2210502296 | E452B2A10011S03 |
| 1790 | 2210502297 | E452B2A10011S04 |
| 1791 | 2210502298 | E452B2A10011S05 |
| 1792 | 2210502299 | E452B2A10011S0A |
| 1793 | 2210502300 | E452B2A10011S0B |
| 1794 | 2210502301 | E452B2A10011S0C |
| 1795 | 2210502302 | E452B2A10011S0D |
| 1796 | 2210502303 | E452B2A10011S0E |
| 1797 | 2210502304 | E452B2A10011S0G |
| 1798 | 2210502305 | E452B2A10011S0H |
| 1799 | 2210502306 | E452B2A10011S0K |
| 1800 | 2210502307 | E452B2A10011S0L |

| | | | | | | | | | |
|---|--|----------|--|---|--|--------------|--|---|--|
| THIS DRAWING CONTAINS INFORMATION THAT IS PROPRIETARY TO MOLEX ELECTRONIC TECHNOLOGIES, LLC AND SHOULD NOT BE USED WITHOUT WRITTEN PERMISSION | | | | | | | | | |
| DIMENSION UNITS | | SCALE | | CURRENT REV DESC: REVISION CREATED FOR REMOVING PRE-RELEASE STAMP | | | |  E452XXXXXXXXXX DIN FORM A EN 175301-803 | |
| mm | | NTS | | | | | | | |
| GENERAL TOLERANCES (UNLESS SPECIFIED) | | | | | | | | | |
| | | MM | | INCH | | | | | |
| 4 PLACES | | ± | | ± | | | | | |
| 3 PLACES | | ± | | ± | | | | | |
| 2 PLACES | | ± | | ± | | | | | |
| 1 PLACE | | ± | | ± | | | | | |
| 0 PLACES | | ± | | ± | | | | | |
| ANGULAR TOL | | ± ° | | | | | | | |
| DRAFT WHERE APPLICABLE MUST REMAIN WITHIN DIMENSIONS | | | | FIRST ANGLE PROJECTION | | DRAWING | | SERIES | |
| | | | |  | | A3-SIZE | | 121050 | |
| DOCUMENT STATUS | | | | P1 | | RELEASE DATE | | 2022/07/19 09:04:35 | |
| DOCUMENT NUMBER | | DOC TYPE | | DOC PART | | REVISION | | | |
| SD-121050-001 | | PSD | | 001 | | E1 | | | |
| MATERIAL NUMBER | | | | CUSTOMER | | SHEET NUMBER | | | |
| SEE TABLE | | | | GENERAL MARKET | | 14 OF 41 | | | |

TABLE 3 - PART LIST

| Pos. | Molex PN: | Engineering No.: |
|------|------------|------------------|
| 1801 | 2210502308 | E452B2A10011S0M |
| 1802 | 2210502309 | E452B2A10K11000 |
| 1803 | 2210502310 | E452B2A10K11A11 |
| 1804 | 2210502311 | E452B2A10K11A12 |
| 1805 | 2210502312 | E452B2A10K11A13 |
| 1806 | 2210502313 | E452B2A10K11A14 |
| 1807 | 2210502314 | E452B2A10K11A15 |
| 1808 | 2210502315 | E452B2A10K11A1A |
| 1809 | 2210502316 | E452B2A10K11A1B |
| 1810 | 2210502317 | E452B2A10K11A1C |
| 1811 | 2210502318 | E452B2A10K11A1D |
| 1812 | 2210502319 | E452B2A10K11A1E |
| 1813 | 2210502320 | E452B2A10K11A1G |
| 1814 | 2210502321 | E452B2A10K11A1H |
| 1815 | 2210502322 | E452B2A10K11A1K |
| 1816 | 2210502323 | E452B2A10K11A1L |
| 1817 | 2210502324 | E452B2A10K11A1M |
| 1818 | 2210502325 | E452B2A10K11C31 |
| 1819 | 2210502326 | E452B2A10K11C32 |
| 1820 | 2210502327 | E452B2A10K11C33 |
| 1821 | 2210502328 | E452B2A10K11C34 |
| 1822 | 2210502329 | E452B2A10K11C35 |
| 1823 | 2210502330 | E452B2A10K11C3A |
| 1824 | 2210502331 | E452B2A10K11C3B |
| 1825 | 2210502332 | E452B2A10K11C3C |
| 1826 | 2210502333 | E452B2A10K11C3D |
| 1827 | 2210502334 | E452B2A10K11C3E |
| 1828 | 2210502335 | E452B2A10K11C3G |
| 1829 | 2210502336 | E452B2A10K11C3H |
| 1830 | 2210502337 | E452B2A10K11C3K |
| 1831 | 2210502338 | E452B2A10K11C3L |
| 1832 | 2210502339 | E452B2A10K11C3M |
| 1833 | 2210502340 | E452B2A10K11C41 |
| 1834 | 2210502341 | E452B2A10K11C42 |
| 1835 | 2210502342 | E452B2A10K11C43 |
| 1836 | 2210502343 | E452B2A10K11C44 |
| 1837 | 2210502344 | E452B2A10K11C45 |
| 1838 | 2210502345 | E452B2A10K11C4A |
| 1839 | 2210502346 | E452B2A10K11C4B |
| 1840 | 2210502347 | E452B2A10K11C4C |

| Pos. | Molex PN: | Engineering No.: |
|------|------------|------------------|
| 1841 | 2210502348 | E452B2A10K11C4D |
| 1842 | 2210502349 | E452B2A10K11C4E |
| 1843 | 2210502350 | E452B2A10K11C4G |
| 1844 | 2210502351 | E452B2A10K11C4H |
| 1845 | 2210502352 | E452B2A10K11C4K |
| 1846 | 2210502353 | E452B2A10K11C4L |
| 1847 | 2210502354 | E452B2A10K11C4M |
| 1848 | 2210502359 | E452B2A10K11E05 |
| 1849 | N/A | N/A |
| 1850 | N/A | N/A |
| 1851 | N/A | N/A |
| 1852 | N/A | N/A |
| 1853 | 2210502374 | E452B2A10K11R05 |
| 1854 | N/A | N/A |
| 1855 | N/A | N/A |
| 1856 | N/A | N/A |
| 1857 | N/A | N/A |
| 1858 | N/A | N/A |
| 1859 | N/A | N/A |
| 1860 | N/A | N/A |
| 1861 | N/A | N/A |
| 1862 | N/A | N/A |
| 1863 | N/A | N/A |
| 1864 | 2210502385 | E452B2A10K11R21 |
| 1865 | 2210502386 | E452B2A10K11R22 |
| 1866 | 2210502387 | E452B2A10K11R23 |
| 1867 | 2210502388 | E452B2A10K11R24 |
| 1868 | 2210502389 | E452B2A10K11R25 |
| 1869 | 2210502390 | E452B2A10K11R2A |
| 1870 | 2210502391 | E452B2A10K11R2B |
| 1871 | 2210502392 | E452B2A10K11R2C |
| 1872 | 2210502393 | E452B2A10K11R2D |
| 1873 | 2210502394 | E452B2A10K11R2E |
| 1874 | 2210502395 | E452B2A10K11R2G |
| 1875 | 2210502396 | E452B2A10K11R2H |
| 1876 | 2210502397 | E452B2A10K11R2K |
| 1877 | 2210502398 | E452B2A10K11R2L |
| 1878 | 2210502399 | E452B2A10K11R2M |
| 1879 | 2210502400 | E452B2A10K11S01 |
| 1880 | 2210502401 | E452B2A10K11S02 |

| Pos. | Molex PN: | Engineering No.: |
|------|------------|------------------|
| 1881 | 2210502402 | E452B2A10K11S03 |
| 1882 | 2210502403 | E452B2A10K11S04 |
| 1883 | 2210502404 | E452B2A10K11S05 |
| 1884 | 2210502405 | E452B2A10K11S0A |
| 1885 | 2210502406 | E452B2A10K11S0B |
| 1886 | 2210502407 | E452B2A10K11S0C |
| 1887 | 2210502408 | E452B2A10K11S0D |
| 1888 | 2210502409 | E452B2A10K11S0E |
| 1889 | 2210502410 | E452B2A10K11S0G |
| 1890 | 2210502411 | E452B2A10K11S0H |
| 1891 | 2210502412 | E452B2A10K11S0K |
| 1892 | 2210502413 | E452B2A10K11S0L |
| 1893 | 2210502414 | E452B2A10K11S0M |
| 1894 | 2210502415 | E452B2A15011000 |
| 1895 | 2210502416 | E452B2A15011A11 |
| 1896 | 2210502417 | E452B2A15011A12 |
| 1897 | 2210502418 | E452B2A15011A13 |
| 1898 | 2210502419 | E452B2A15011A14 |
| 1899 | 2210502420 | E452B2A15011A15 |
| 1900 | 2210502421 | E452B2A15011A1A |
| 1901 | 2210502422 | E452B2A15011A1B |
| 1902 | 2210502423 | E452B2A15011A1C |
| 1903 | 2210502424 | E452B2A15011A1D |
| 1904 | 2210502425 | E452B2A15011A1E |
| 1905 | 2210502426 | E452B2A15011A1G |
| 1906 | 2210502427 | E452B2A15011A1H |
| 1907 | 2210502428 | E452B2A15011A1K |
| 1908 | 2210502429 | E452B2A15011A1L |
| 1909 | 2210502430 | E452B2A15011A1M |
| 1910 | 2210502431 | E452B2A15011C31 |
| 1911 | 2210502432 | E452B2A15011C32 |
| 1912 | 2210502433 | E452B2A15011C33 |
| 1913 | 2210502434 | E452B2A15011C34 |
| 1914 | 2210502435 | E452B2A15011C35 |
| 1915 | 2210502436 | E452B2A15011C3A |
| 1916 | 2210502437 | E452B2A15011C3B |
| 1917 | 2210502438 | E452B2A15011C3C |
| 1918 | 2210502439 | E452B2A15011C3D |
| 1919 | 2210502440 | E452B2A15011C3E |
| 1920 | 2210502441 | E452B2A15011C3G |

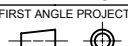
| Pos. | Molex PN: | Engineering No.: |
|------|------------|------------------|
| 1921 | 2210502442 | E452B2A15011C3H |
| 1922 | 2210502443 | E452B2A15011C3K |
| 1923 | 2210502444 | E452B2A15011C3L |
| 1924 | 2210502445 | E452B2A15011C3M |
| 1925 | 2210502446 | E452B2A15011C41 |
| 1926 | 2210502447 | E452B2A15011C42 |
| 1927 | 2210502448 | E452B2A15011C43 |
| 1928 | 2210502449 | E452B2A15011C44 |
| 1929 | 2210502450 | E452B2A15011C45 |
| 1930 | 2210502451 | E452B2A15011C4A |
| 1931 | 2210502452 | E452B2A15011C4B |
| 1932 | 2210502453 | E452B2A15011C4C |
| 1933 | 2210502454 | E452B2A15011C4D |
| 1934 | 2210502455 | E452B2A15011C4E |
| 1935 | 2210502456 | E452B2A15011C4G |
| 1936 | 2210502457 | E452B2A15011C4H |
| 1937 | 2210502458 | E452B2A15011C4K |
| 1938 | 2210502459 | E452B2A15011C4L |
| 1939 | 2210502460 | E452B2A15011C4M |
| 1940 | 2210502465 | E452B2A15011E05 |
| 1941 | N/A | N/A |
| 1942 | N/A | N/A |
| 1943 | N/A | N/A |
| 1944 | N/A | N/A |
| 1945 | 2210502480 | E452B2A15011R05 |
| 1946 | N/A | N/A |
| 1947 | N/A | N/A |
| 1948 | N/A | N/A |
| 1949 | N/A | N/A |
| 1950 | N/A | N/A |
| 1951 | N/A | N/A |
| 1952 | N/A | N/A |
| 1953 | N/A | N/A |
| 1954 | N/A | N/A |
| 1955 | N/A | N/A |
| 1956 | 2210502491 | E452B2A15011R21 |
| 1957 | 2210502492 | E452B2A15011R22 |
| 1958 | 2210502493 | E452B2A15011R23 |
| 1959 | 2210502494 | E452B2A15011R24 |
| 1960 | 2210502495 | E452B2A15011R25 |

| | | | | | |
|---|--|---|--|---|--|
| THIS DRAWING CONTAINS INFORMATION THAT IS PROPRIETARY TO MOLEX ELECTRONIC TECHNOLOGIES, LLC AND SHOULD NOT BE USED WITHOUT WRITTEN PERMISSION | | CURRENT REV DESC: REVISION CREATED FOR REMOVING PRE-RELEASE STAMP | |  E452XXXXXXXXXX DIN FORM A EN 175301-803 | |
| DIMENSION UNITS: mm SCALE: NTS GENERAL TOLERANCES (UNLESS SPECIFIED): 4 PLACES ± 3 PLACES ± 2 PLACES ± 1 PLACE ± 0 PLACES ± ANGULAR TOL ± ° | | EC NO: 714567 DRWN: SUGEEB CHK'D: GGA APPR: GGA INITIAL REVISION: DRWN: JMARSZALEK APPR: MDYSZEWSKA | | | |
| DRAFT WHERE APPLICABLE MUST REMAIN WITHIN DIMENSIONS  | | FIRST ANGLE PROJECTION DRAWING: A3-SIZE SERIES: 121050 | | DOCUMENT NUMBER: SD-121050-001 DOC TYPE: PSD DOC PART: 001 REVISION: E1 | |
| MATERIAL NUMBER: SEE TABLE CUSTOMER: GENERAL MARKET SHEET NUMBER: 15 OF 41 | | | | | |

TABLE 3 - PART LIST

| Pos. | Molex PN: | Engineering No.: |
|------|------------|------------------|
| 1961 | 2210502496 | E452B2A15011R2A |
| 1962 | 2210502497 | E452B2A15011R2B |
| 1963 | 2210502498 | E452B2A15011R2C |
| 1964 | 2210502499 | E452B2A15011R2D |
| 1965 | 2210502500 | E452B2A15011R2E |
| 1966 | 2210502501 | E452B2A15011R2G |
| 1967 | 2210502502 | E452B2A15011R2H |
| 1968 | 2210502503 | E452B2A15011R2K |
| 1969 | 2210502504 | E452B2A15011R2L |
| 1970 | 2210502505 | E452B2A15011R2M |
| 1971 | 2210502506 | E452B2A15011S01 |
| 1972 | 2210502507 | E452B2A15011S02 |
| 1973 | 2210502508 | E452B2A15011S03 |
| 1974 | 2210502509 | E452B2A15011S04 |
| 1975 | 2210502510 | E452B2A15011S05 |
| 1976 | 2210502511 | E452B2A15011S0A |
| 1977 | 2210502512 | E452B2A15011S0B |
| 1978 | 2210502513 | E452B2A15011S0C |
| 1979 | 2210502514 | E452B2A15011S0D |
| 1980 | 2210502515 | E452B2A15011S0E |
| 1981 | 2210502516 | E452B2A15011S0G |
| 1982 | 2210502517 | E452B2A15011S0H |
| 1983 | 2210502518 | E452B2A15011S0K |
| 1984 | 2210502519 | E452B2A15011S0L |
| 1985 | 2210502520 | E452B2A15011S0M |
| 1986 | 2210502521 | E452B2A20011000 |
| 1987 | 2210502522 | E452B2A20011A11 |
| 1988 | 2210502523 | E452B2A20011A12 |
| 1989 | 2210502524 | E452B2A20011A13 |
| 1990 | 2210502525 | E452B2A20011A14 |
| 1991 | 2210502526 | E452B2A20011A15 |
| 1992 | 2210502527 | E452B2A20011A1A |
| 1993 | 2210502528 | E452B2A20011A1B |
| 1994 | 2210502529 | E452B2A20011A1C |
| 1995 | 2210502530 | E452B2A20011A1D |
| 1996 | 2210502531 | E452B2A20011A1E |
| 1997 | 2210502532 | E452B2A20011A1G |
| 1998 | 2210502533 | E452B2A20011A1H |
| 1999 | 2210502534 | E452B2A20011A1K |
| 2000 | 2210502535 | E452B2A20011A1L |

| Pos. | Molex PN: | Engineering No.: |
|------|------------|------------------|
| 2001 | 2210502536 | E452B2A20011A1M |
| 2002 | 2210502537 | E452B2A20011C31 |
| 2003 | 2210502538 | E452B2A20011C32 |
| 2004 | 2210502539 | E452B2A20011C33 |
| 2005 | 2210502540 | E452B2A20011C34 |
| 2006 | 2210502541 | E452B2A20011C35 |
| 2007 | 2210502542 | E452B2A20011C3A |
| 2008 | 2210502543 | E452B2A20011C3B |
| 2009 | 2210502544 | E452B2A20011C3C |
| 2010 | 2210502545 | E452B2A20011C3D |
| 2011 | 2210502546 | E452B2A20011C3E |
| 2012 | 2210502547 | E452B2A20011C3G |
| 2013 | 2210502548 | E452B2A20011C3H |
| 2014 | 2210502549 | E452B2A20011C3K |
| 2015 | 2210502550 | E452B2A20011C3L |
| 2016 | 2210502551 | E452B2A20011C3M |
| 2017 | 2210502552 | E452B2A20011C41 |
| 2018 | 2210502553 | E452B2A20011C42 |
| 2019 | 2210502554 | E452B2A20011C43 |
| 2020 | 2210502555 | E452B2A20011C44 |
| 2021 | 2210502556 | E452B2A20011C45 |
| 2022 | 2210502557 | E452B2A20011C4A |
| 2023 | 2210502558 | E452B2A20011C4B |
| 2024 | 2210502559 | E452B2A20011C4C |
| 2025 | 2210502560 | E452B2A20011C4D |
| 2026 | 2210502561 | E452B2A20011C4E |
| 2027 | 2210502562 | E452B2A20011C4G |
| 2028 | 2210502563 | E452B2A20011C4H |
| 2029 | 2210502564 | E452B2A20011C4K |
| 2030 | 2210502565 | E452B2A20011C4L |
| 2031 | 2210502566 | E452B2A20011C4M |
| 2032 | 2210502571 | E452B2A20011E05 |
| 2033 | N/A | N/A |
| 2034 | N/A | N/A |
| 2035 | N/A | N/A |
| 2036 | N/A | N/A |
| 2037 | 2210502586 | E452B2A20011R05 |
| 2038 | N/A | N/A |
| 2039 | N/A | N/A |
| 2040 | N/A | N/A |

| Pos. | Molex PN: | Engineering No.: |
|------|------------|------------------|
| 2041 | N/A | N/A |
| 2042 | N/A | N/A |
| 2043 | N/A | N/A |
| 2044 | N/A | N/A |
| 2045 | N/A | N/A |
| 2046 | N/A | N/A |
| 2047 | N/A | N/A |
| 2048 | 2210502597 | E452B2A20011R21 |
| 2049 | 2210502598 | E452B2A20011R22 |
| 2050 | 2210502599 | E452B2A20011R23 |
| 2051 | 2210502600 | E452B2A20011R24 |
| 2052 | 2210502601 | E452B2A20011R25 |
| 2053 | 2210502602 | E452B2A20011R2A |
| 2054 | 2210502603 | E452B2A20011R2B |
| 2055 | 2210502604 | E452B2A20011R2C |
| 2056 | 2210502605 | E452B2A20011R2D |
| 2057 | 2210502606 | E452B2A20011R2E |
| 2058 | 2210502607 | E452B2A20011R2G |
| 2059 | 2210502608 | E452B2A20011R2H |
| 2060 | 2210502609 | E452B2A20011R2K |
| 2061 | 2210502610 | E452B2A20011R2L |
| 2062 | 2210502611 | E452B2A20011R2M |
| 2063 | 2210502612 | E452B2A20011S01 |
| 2064 | 2210502613 | E452B2A20011S02 |
| 2065 | 2210502614 | E452B2A20011S03 |
| 2066 | 2210502615 | E452B2A20011S04 |
| 2067 | 2210502616 | E452B2A20011S05 |
| 2068 | 2210502617 | E452B2A20011S0A |
| 2069 | 2210502618 | E452B2A20011S0B |
| 2070 | 2210502619 | E452B2A20011S0C |
| 2071 | 2210502620 | E452B2A20011S0D |
| 2072 | 2210502621 | E452B2A20011S0E |
| 2073 | 2210502622 | E452B2A20011S0G |
| 2074 | 2210502623 | E452B2A20011S0H |
| 2075 | 2210502624 | E452B2A20011S0K |
| 2076 | 2210502625 | E452B2A20011S0L |
| 2077 | 2210502626 | E452B2A20011S0M |
| 2078 | 2210502627 | E452B2A30011000 |
| 2079 | 2210502628 | E452B2A30011A11 |
| 2080 | 2210502629 | E452B2A30011A12 |

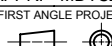
| Pos. | Molex PN: | Engineering No.: |
|------|------------|------------------|
| 2081 | 2210502630 | E452B2A30011A13 |
| 2082 | 2210502631 | E452B2A30011A14 |
| 2083 | 2210502632 | E452B2A30011A1A |
| 2084 | 2210502633 | E452B2A30011A1B |
| 2085 | 2210502634 | E452B2A30011A1C |
| 2086 | 2210502635 | E452B2A30011A1D |
| 2087 | 2210502636 | E452B2A30011A1E |
| 2088 | 2210502637 | E452B2A30011A1G |
| 2089 | 2210502638 | E452B2A30011A1H |
| 2090 | 2210502639 | E452B2A30011A1K |
| 2091 | 2210502640 | E452B2A30011A1L |
| 2092 | 2210502641 | E452B2A30011A1M |
| 2093 | 2210502642 | E452B2A30011C31 |
| 2094 | 2210502643 | E452B2A30011C32 |
| 2095 | 2210502644 | E452B2A30011C33 |
| 2096 | 2210502645 | E452B2A30011C34 |
| 2097 | 2210502646 | E452B2A30011C35 |
| 2098 | 2210502647 | E452B2A30011C3A |
| 2099 | 2210502648 | E452B2A30011C3B |
| 2100 | 2210502649 | E452B2A30011C3C |
| 2101 | 2210502650 | E452B2A30011C3D |
| 2102 | 2210502651 | E452B2A30011C3E |
| 2103 | 2210502652 | E452B2A30011C3G |
| 2104 | 2210502653 | E452B2A30011C3H |
| 2105 | 2210502654 | E452B2A30011C3K |
| 2106 | 2210502655 | E452B2A30011C3L |
| 2107 | 2210502656 | E452B2A30011C3M |
| 2108 | 2210502657 | E452B2A30011C41 |
| 2109 | 2210502658 | E452B2A30011C42 |
| 2110 | 2210502659 | E452B2A30011C43 |
| 2111 | 2210502660 | E452B2A30011C44 |
| 2112 | 2210502661 | E452B2A30011C45 |
| 2113 | 2210502662 | E452B2A30011C4A |
| 2114 | 2210502663 | E452B2A30011C4B |
| 2115 | 2210502664 | E452B2A30011C4C |
| 2116 | 2210502665 | E452B2A30011C4D |
| 2117 | 2210502666 | E452B2A30011C4E |
| 2118 | 2210502667 | E452B2A30011C4G |
| 2119 | 2210502668 | E452B2A30011C4H |
| 2120 | 2210502669 | E452B2A30011C4K |

| | | | | | | | |
|---|---|---------------------------------|--|---|--|--|--|
| THIS DRAWING CONTAINS INFORMATION THAT IS PROPRIETARY TO MOLEX ELECTRONIC TECHNOLOGIES, LLC AND SHOULD NOT BE USED WITHOUT WRITTEN PERMISSION | | SCALE mm NTS | | CURRENT REV DESC: REVISION CREATED FOR REMOVING PRE-RELEASE STAMP | | molex | |
| GENERAL TOLERANCES (UNLESS SPECIFIED) | | MM INCH | | EC NO: 714567 DRWN: SUGEEB CHK'D: GGA APPR: GGA | | | |
| 4 PLACES | ± | ± | | 2022/07/18 | | E452XXXXXXXXXX DIN FORM A EN 175301-803 | |
| 3 PLACES | ± | ± | | 2022/07/19 | | | |
| 2 PLACES | ± | ± | | 2022/07/19 | | PRODUCT CUSTOMER DRAWING | |
| 1 PLACE | ± | ± | | INITIAL REVISION: | | | |
| 0 PLACES | ± | ± | | DRWN: JMARSZALEK APPR: MDYSZEWSKA | | DOCUMENT NUMBER SD-121050-001 | |
| ANGULAR TOL ± ° | | FIRST ANGLE PROJECTION | | DRAWING | | DOC TYPE DOC PART REVISION | |
| DRAFT WHERE APPLICABLE MUST REMAIN WITHIN DIMENSIONS | | SERIES | | MATERIAL NUMBER | | CUSTOMER | |
| | | A3-SIZE | | 121050 | | SEE TABLE GENERAL MARKET | |
| | | | | | | SHEET NUMBER 16 OF 41 | |

TABLE 3 - PART LIST

| Pos. | Molex PN: | Engineering No.: |
|------|------------|------------------|
| 2121 | 2210502670 | E452B2A30011C4L |
| 2122 | 2210502671 | E452B2A30011C4M |
| 2123 | 2210502676 | E452B2A30011E05 |
| 2124 | N/A | N/A |
| 2125 | N/A | N/A |
| 2126 | N/A | N/A |
| 2127 | N/A | N/A |
| 2128 | 2210502691 | E452B2A30011R05 |
| 2129 | N/A | N/A |
| 2130 | N/A | N/A |
| 2131 | N/A | N/A |
| 2132 | N/A | N/A |
| 2133 | N/A | N/A |
| 2134 | N/A | N/A |
| 2135 | N/A | N/A |
| 2136 | N/A | N/A |
| 2137 | N/A | N/A |
| 2138 | N/A | N/A |
| 2139 | 2210502702 | E452B2A30011R21 |
| 2140 | 2210502703 | E452B2A30011R22 |
| 2141 | 2210502704 | E452B2A30011R23 |
| 2142 | 2210502705 | E452B2A30011R24 |
| 2143 | 2210502706 | E452B2A30011R25 |
| 2144 | 2210502707 | E452B2A30011R2A |
| 2145 | 2210502708 | E452B2A30011R2B |
| 2146 | 2210502709 | E452B2A30011R2C |
| 2147 | 2210502710 | E452B2A30011R2D |
| 2148 | 2210502711 | E452B2A30011R2E |
| 2149 | 2210502712 | E452B2A30011R2G |
| 2150 | 2210502713 | E452B2A30011R2H |
| 2151 | 2210502714 | E452B2A30011R2K |
| 2152 | 2210502715 | E452B2A30011R2L |
| 2153 | 2210502716 | E452B2A30011R2M |
| 2154 | 2210502717 | E452B2A30011S01 |
| 2155 | 2210502718 | E452B2A30011S02 |
| 2156 | 2210502719 | E452B2A30011S03 |
| 2157 | 2210502720 | E452B2A30011S04 |
| 2158 | 2210502721 | E452B2A30011S05 |
| 2159 | 2210502722 | E452B2A30011S0A |
| 2160 | 2210502723 | E452B2A30011S0B |

| Pos. | Molex PN: | Engineering No.: |
|------|------------|------------------|
| 2161 | 2210502724 | E452B2A30011S0C |
| 2162 | 2210502725 | E452B2A30011S0D |
| 2163 | 2210502726 | E452B2A30011S0E |
| 2164 | 2210502727 | E452B2A30011S0G |
| 2165 | 2210502728 | E452B2A30011S0H |
| 2166 | 2210502729 | E452B2A30011S0K |
| 2167 | 2210502730 | E452B2A30011S0L |
| 2168 | 2210502731 | E452B2A30011S0M |
| 2169 | 2210502732 | E452B2A50011000 |
| 2170 | 2210502733 | E452B2A50011A11 |
| 2171 | 2210502734 | E452B2A50011A12 |
| 2172 | 2210502735 | E452B2A50011A13 |
| 2173 | 2210502736 | E452B2A50011A14 |
| 2174 | 2210502737 | E452B2A50011A15 |
| 2175 | 2210502738 | E452B2A50011A1A |
| 2176 | 2210502739 | E452B2A50011A1B |
| 2177 | 2210502740 | E452B2A50011A1C |
| 2178 | 2210502741 | E452B2A50011A1D |
| 2179 | 2210502742 | E452B2A50011A1E |
| 2180 | 2210502743 | E452B2A50011A1G |
| 2181 | 2210502744 | E452B2A50011A1H |
| 2182 | 2210502745 | E452B2A50011A1K |
| 2183 | 2210502746 | E452B2A50011A1L |
| 2184 | 2210502747 | E452B2A50011A1M |
| 2185 | 2210502748 | E452B2A50011C31 |
| 2186 | 2210502749 | E452B2A50011C32 |
| 2187 | 2210502750 | E452B2A50011C33 |
| 2188 | 2210502751 | E452B2A50011C34 |
| 2189 | 2210502752 | E452B2A50011C35 |
| 2190 | 2210502753 | E452B2A50011C3A |
| 2191 | 2210502754 | E452B2A50011C3B |
| 2192 | 2210502755 | E452B2A50011C3C |
| 2193 | 2210502756 | E452B2A50011C3D |
| 2194 | 2210502757 | E452B2A50011C3E |
| 2195 | 2210502758 | E452B2A50011C3G |
| 2196 | 2210502759 | E452B2A50011C3H |
| 2197 | 2210502760 | E452B2A50011C3K |
| 2198 | 2210502761 | E452B2A50011C3L |
| 2199 | 2210502762 | E452B2A50011C3M |
| 2200 | 2210502763 | E452B2A50011C41 |

| Pos. | Molex PN: | Engineering No.: |
|------|------------|------------------|
| 2201 | 2210502764 | E452B2A50011C42 |
| 2202 | 2210502765 | E452B2A50011C43 |
| 2203 | 2210502766 | E452B2A50011C44 |
| 2204 | 2210502767 | E452B2A50011C45 |
| 2205 | 2210502768 | E452B2A50011C4A |
| 2206 | 2210502769 | E452B2A50011C4B |
| 2207 | 2210502770 | E452B2A50011C4C |
| 2208 | 2210502771 | E452B2A50011C4D |
| 2209 | 2210502772 | E452B2A50011C4E |
| 2210 | 2210502773 | E452B2A50011C4G |
| 2211 | 2210502774 | E452B2A50011C4K |
| 2212 | 2210502775 | E452B2A50011C4L |
| 2213 | 2210502776 | E452B2A50011C4M |
| 2214 | 2210502781 | E452B2A50011E05 |
| 2215 | N/A | N/A |
| 2216 | N/A | N/A |
| 2217 | N/A | N/A |
| 2218 | N/A | N/A |
| 2219 | 2210502796 | E452B2A50011R05 |
| 2220 | N/A | N/A |
| 2221 | N/A | N/A |
| 2222 | N/A | N/A |
| 2223 | N/A | N/A |
| 2224 | N/A | N/A |
| 2225 | N/A | N/A |
| 2226 | N/A | N/A |
| 2227 | N/A | N/A |
| 2228 | N/A | N/A |
| 2229 | N/A | N/A |
| 2230 | 2210502807 | E452B2A50011R21 |
| 2231 | 2210502808 | E452B2A50011R22 |
| 2232 | 2210502809 | E452B2A50011R23 |
| 2233 | 2210502810 | E452B2A50011R24 |
| 2234 | 2210502811 | E452B2A50011R25 |
| 2235 | 2210502812 | E452B2A50011R2A |
| 2236 | 2210502813 | E452B2A50011R2B |
| 2237 | 2210502814 | E452B2A50011R2C |
| 2238 | 2210502815 | E452B2A50011R2D |
| 2239 | 2210502816 | E452B2A50011R2E |
| 2240 | 2210502817 | E452B2A50011R2G |

| Pos. | Molex PN: | Engineering No.: |
|------|------------|------------------|
| 2241 | 2210502818 | E452B2A50011R2H |
| 2242 | 2210502819 | E452B2A50011R2K |
| 2243 | 2210502820 | E452B2A50011R2L |
| 2244 | 2210502821 | E452B2A50011R2M |
| 2245 | 2210502822 | E452B2A50011S01 |
| 2246 | 2210502823 | E452B2A50011S02 |
| 2247 | 2210502824 | E452B2A50011S03 |
| 2248 | 2210502825 | E452B2A50011S04 |
| 2249 | 2210502826 | E452B2A50011S05 |
| 2250 | 2210502827 | E452B2A50011S0A |
| 2251 | 2210502828 | E452B2A50011S0B |
| 2252 | 2210502829 | E452B2A50011S0C |
| 2253 | 2210502830 | E452B2A50011S0D |
| 2254 | 2210502831 | E452B2A50011S0E |
| 2255 | 2210502832 | E452B2A50011S0G |
| 2256 | 2210502833 | E452B2A50011S0H |
| 2257 | 2210502834 | E452B2A50011S0K |
| 2258 | 2210502835 | E452B2A50011S0L |
| 2259 | 2210502836 | E452B2A50011S0M |
| 2260 | 2210502837 | E452B3A10011000 |
| 2261 | 2210502838 | E452B3A10011A11 |
| 2262 | 2210502839 | E452B3A10011A12 |
| 2263 | 2210502840 | E452B3A10011A13 |
| 2264 | 2210502841 | E452B3A10011A14 |
| 2265 | 2210502842 | E452B3A10011A15 |
| 2266 | 2210502843 | E452B3A10011A1A |
| 2267 | 2210502844 | E452B3A10011A1B |
| 2268 | 2210502845 | E452B3A10011A1C |
| 2269 | 2210502846 | E452B3A10011A1D |
| 2270 | 2210502847 | E452B3A10011A1E |
| 2271 | 2210502848 | E452B3A10011A1G |
| 2272 | 2210502849 | E452B3A10011A1H |
| 2273 | 2210502850 | E452B3A10011A1K |
| 2274 | 2210502851 | E452B3A10011A1L |
| 2275 | 2210502852 | E452B3A10011A1M |
| 2276 | 2210502853 | E452B3A10011C31 |
| 2277 | 2210502854 | E452B3A10011C32 |
| 2278 | 2210502855 | E452B3A10011C33 |
| 2279 | 2210502856 | E452B3A10011C34 |
| 2280 | 2210502857 | E452B3A10011C35 |

| | | | | | | | | | | | |
|---|--|-------|--|---|--|---------|--|----------------|--|---|--|
| THIS DRAWING CONTAINS INFORMATION THAT IS PROPRIETARY TO MOLEX ELECTRONIC TECHNOLOGIES, LLC AND SHOULD NOT BE USED WITHOUT WRITTEN PERMISSION | | | | | | | | | | | |
| DIMENSION UNITS | | SCALE | | CURRENT REV DESC: REVISION CREATED FOR REMOVING PRE-RELEASE STAMP | | | | | |  E452XXXXXXXXXX DIN FORM A EN 175301-803 | |
| mm | | NTS | | | | | | | | | |
| GENERAL TOLERANCES (UNLESS SPECIFIED) | | | | | | | | | | | |
| | | MM | | INCH | | | | | | | |
| 4 PLACES | | ± | | ± | | | | | | | |
| 3 PLACES | | ± | | ± | | | | | | | |
| 2 PLACES | | ± | | ± | | | | | | | |
| 1 PLACE | | ± | | ± | | | | | | | |
| 0 PLACES | | ± | | ± | | | | | | | |
| ANGULAR TOL | | ± | | ° | | | | | | | |
| DRAFT WHERE APPLICABLE MUST REMAIN WITHIN DIMENSIONS | | | | FIRST ANGLE PROJECTION | | DRAWING | | SERIES | | MATERIAL NUMBER | |
| | | | |  | | A3-SIZE | | 121050 | | SEE TABLE | |
| | | | | | | | | CUSTOMER | | SHEET NUMBER | |
| | | | | | | | | GENERAL MARKET | | 17 OF 41 | |

TABLE 3 - PART LIST

| Pos. | Molex PN: | Engineering No.: |
|------|------------|------------------|
| 2281 | 2210502858 | E452B3A10011C3A |
| 2282 | 2210502859 | E452B3A10011C3B |
| 2283 | 2210502860 | E452B3A10011C3C |
| 2284 | 2210502861 | E452B3A10011C3D |
| 2285 | 2210502862 | E452B3A10011C3E |
| 2286 | 2210502863 | E452B3A10011C3G |
| 2287 | 2210502864 | E452B3A10011C3H |
| 2288 | 2210502865 | E452B3A10011C3K |
| 2289 | 2210502866 | E452B3A10011C3L |
| 2290 | 2210502867 | E452B3A10011C3M |
| 2291 | 2210502868 | E452B3A10011C41 |
| 2292 | 2210502869 | E452B3A10011C42 |
| 2293 | 2210502870 | E452B3A10011C43 |
| 2294 | 2210502871 | E452B3A10011C44 |
| 2295 | 2210502872 | E452B3A10011C45 |
| 2296 | 2210502873 | E452B3A10011C4A |
| 2297 | 2210502874 | E452B3A10011C4B |
| 2298 | 2210502875 | E452B3A10011C4C |
| 2299 | 2210502876 | E452B3A10011C4D |
| 2300 | 2210502877 | E452B3A10011C4E |
| 2301 | 2210502878 | E452B3A10011C4G |
| 2302 | 2210502879 | E452B3A10011C4H |
| 2303 | 2210502880 | E452B3A10011C4K |
| 2304 | 2210502881 | E452B3A10011C4L |
| 2305 | 2210502882 | E452B3A10011C4M |
| 2306 | 2210502887 | E452B3A10011E05 |
| 2307 | N/A | N/A |
| 2308 | N/A | N/A |
| 2309 | N/A | N/A |
| 2310 | N/A | N/A |
| 2311 | 2210502902 | E452B3A10011R05 |
| 2312 | N/A | N/A |
| 2313 | N/A | N/A |
| 2314 | N/A | N/A |
| 2315 | N/A | N/A |
| 2316 | N/A | N/A |
| 2317 | N/A | N/A |
| 2318 | N/A | N/A |
| 2319 | N/A | N/A |
| 2320 | N/A | N/A |

| Pos. | Molex PN: | Engineering No.: |
|------|------------|------------------|
| 2321 | N/A | N/A |
| 2322 | 2210502913 | E452B3A10011R21 |
| 2323 | 2210502914 | E452B3A10011R22 |
| 2324 | 2210502915 | E452B3A10011R23 |
| 2325 | 2210502916 | E452B3A10011R24 |
| 2326 | 2210502917 | E452B3A10011R25 |
| 2327 | 2210502918 | E452B3A10011R2A |
| 2328 | 2210502919 | E452B3A10011R2B |
| 2329 | 2210502920 | E452B3A10011R2C |
| 2330 | 2210502921 | E452B3A10011R2D |
| 2331 | 2210502922 | E452B3A10011R2E |
| 2332 | 2210502923 | E452B3A10011R2G |
| 2333 | 2210502924 | E452B3A10011R2H |
| 2334 | 2210502925 | E452B3A10011R2K |
| 2335 | 2210502926 | E452B3A10011R2L |
| 2336 | 2210502927 | E452B3A10011R2M |
| 2337 | 2210502928 | E452B3A10011S01 |
| 2338 | 2210502929 | E452B3A10011S02 |
| 2339 | 2210502930 | E452B3A10011S03 |
| 2340 | 2210502931 | E452B3A10011S04 |
| 2341 | 2210502932 | E452B3A10011S05 |
| 2342 | 2210502933 | E452B3A10011S0A |
| 2343 | 2210502934 | E452B3A10011S0B |
| 2344 | 2210502935 | E452B3A10011S0C |
| 2345 | 2210502936 | E452B3A10011S0D |
| 2346 | 2210502937 | E452B3A10011S0E |
| 2347 | 2210502938 | E452B3A10011S0G |
| 2348 | 2210502939 | E452B3A10011S0H |
| 2349 | 2210502940 | E452B3A10011S0K |
| 2350 | 2210502941 | E452B3A10011S0L |
| 2351 | 2210502942 | E452B3A10011S0M |
| 2352 | 2210502943 | E452B3A10K11000 |
| 2353 | 2210502944 | E452B3A10K11A11 |
| 2354 | 2210502945 | E452B3A10K11A12 |
| 2355 | 2210502946 | E452B3A10K11A13 |
| 2356 | 2210502947 | E452B3A10K11A14 |
| 2357 | 2210502948 | E452B3A10K11A15 |
| 2358 | 2210502949 | E452B3A10K11A1A |
| 2359 | 2210502950 | E452B3A10K11A1B |
| 2360 | 2210502951 | E452B3A10K11A1C |

| Pos. | Molex PN: | Engineering No.: |
|------|------------|------------------|
| 2361 | 2210502952 | E452B3A10K11A1D |
| 2362 | 2210502953 | E452B3A10K11A1E |
| 2363 | 2210502954 | E452B3A10K11A1G |
| 2364 | 2210502955 | E452B3A10K11A1H |
| 2365 | 2210502956 | E452B3A10K11A1K |
| 2366 | 2210502957 | E452B3A10K11A1L |
| 2367 | 2210502958 | E452B3A10K11A1M |
| 2368 | 2210502959 | E452B3A10K11C31 |
| 2369 | 2210502960 | E452B3A10K11C32 |
| 2370 | 2210502961 | E452B3A10K11C33 |
| 2371 | 2210502962 | E452B3A10K11C34 |
| 2372 | 2210502963 | E452B3A10K11C35 |
| 2373 | 2210502964 | E452B3A10K11C3A |
| 2374 | 2210502965 | E452B3A10K11C3B |
| 2375 | 2210502966 | E452B3A10K11C3C |
| 2376 | 2210502967 | E452B3A10K11C3D |
| 2377 | 2210502968 | E452B3A10K11C3E |
| 2378 | 2210502969 | E452B3A10K11C3G |
| 2379 | 2210502970 | E452B3A10K11C3H |
| 2380 | 2210502971 | E452B3A10K11C3K |
| 2381 | 2210502972 | E452B3A10K11C3L |
| 2382 | 2210502973 | E452B3A10K11C3M |
| 2383 | 2210502974 | E452B3A10K11C41 |
| 2384 | 2210502975 | E452B3A10K11C42 |
| 2385 | 2210502976 | E452B3A10K11C43 |
| 2386 | 2210502977 | E452B3A10K11C44 |
| 2387 | 2210502978 | E452B3A10K11C45 |
| 2388 | 2210502979 | E452B3A10K11C4A |
| 2389 | 2210502980 | E452B3A10K11C4B |
| 2390 | 2210502981 | E452B3A10K11C4C |
| 2391 | 2210502982 | E452B3A10K11C4D |
| 2392 | 2210502983 | E452B3A10K11C4E |
| 2393 | 2210502984 | E452B3A10K11C4G |
| 2394 | 2210502985 | E452B3A10K11C4H |
| 2395 | 2210502986 | E452B3A10K11C4K |
| 2396 | 2210502987 | E452B3A10K11C4L |
| 2397 | 2210502988 | E452B3A10K11C4M |
| 2398 | 2210502993 | E452B3A10K11E05 |
| 2399 | N/A | N/A |
| 2400 | N/A | N/A |

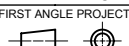
| Pos. | Molex PN: | Engineering No.: |
|------|------------|------------------|
| 2401 | N/A | N/A |
| 2402 | N/A | N/A |
| 2403 | 2210503008 | E452B3A10K11R05 |
| 2404 | N/A | N/A |
| 2405 | N/A | N/A |
| 2406 | N/A | N/A |
| 2407 | N/A | N/A |
| 2408 | N/A | N/A |
| 2409 | N/A | N/A |
| 2410 | N/A | N/A |
| 2411 | N/A | N/A |
| 2412 | N/A | N/A |
| 2413 | N/A | N/A |
| 2414 | 2210503019 | E452B3A10K11R21 |
| 2415 | 2210503020 | E452B3A10K11R22 |
| 2416 | 2210503021 | E452B3A10K11R23 |
| 2417 | 2210503022 | E452B3A10K11R24 |
| 2418 | 2210503023 | E452B3A10K11R25 |
| 2419 | 2210503024 | E452B3A10K11R2A |
| 2420 | 2210503025 | E452B3A10K11R2B |
| 2421 | 2210503026 | E452B3A10K11R2C |
| 2422 | 2210503027 | E452B3A10K11R2D |
| 2423 | 2210503028 | E452B3A10K11R2E |
| 2424 | 2210503029 | E452B3A10K11R2G |
| 2425 | 2210503030 | E452B3A10K11R2H |
| 2426 | 2210503031 | E452B3A10K11R2K |
| 2427 | 2210503032 | E452B3A10K11R2L |
| 2428 | 2210503033 | E452B3A10K11R2M |
| 2429 | 2210503034 | E452B3A10K11S01 |
| 2430 | 2210503035 | E452B3A10K11S02 |
| 2431 | 2210503036 | E452B3A10K11S03 |
| 2432 | 2210503037 | E452B3A10K11S04 |
| 2433 | 2210503038 | E452B3A10K11S05 |
| 2434 | 2210503039 | E452B3A10K11S0A |
| 2435 | 2210503040 | E452B3A10K11S0B |
| 2436 | 2210503041 | E452B3A10K11S0C |
| 2437 | 2210503042 | E452B3A10K11S0D |
| 2438 | 2210503043 | E452B3A10K11S0E |
| 2439 | 2210503044 | E452B3A10K11S0G |
| 2440 | 2210503045 | E452B3A10K11S0H |

| | | | | | | | | | | | |
|---|--|-------|------|---|---|---------|--|----------------|--|---|--|
| THIS DRAWING CONTAINS INFORMATION THAT IS PROPRIETARY TO MOLEX ELECTRONIC TECHNOLOGIES, LLC AND SHOULD NOT BE USED WITHOUT WRITTEN PERMISSION | | | | | | | | | | | |
| DIMENSION UNITS | | SCALE | | CURRENT REV DESC: REVISION CREATED FOR REMOVING PRE-RELEASE STAMP | | | | | |  | |
| mm | | NTS | | | | | | | | | |
| GENERAL TOLERANCES (UNLESS SPECIFIED) | | | | | | | | | | | |
| | | MM | INCH | | | | | | | | |
| 4 PLACES | | ± | ± | | | | | | | | |
| 3 PLACES | | ± | ± | | | | | | | | |
| 2 PLACES | | ± | ± | | | | | | | | |
| 1 PLACE | | ± | ± | | | | | | | | |
| 0 PLACES | | ± | ± | | | | | | | | |
| ANGULAR TOL | | | | ± | ° | | | | | | |
| DRAFT WHERE APPLICABLE MUST REMAIN WITHIN DIMENSIONS | | | | FIRST ANGLE PROJECTION | | DRAWING | | SERIES | | MATERIAL NUMBER | |
| | | | |  | | A3-SIZE | | 121050 | | SEE TABLE | |
| | | | | | | | | CUSTOMER | | SHEET NUMBER | |
| | | | | | | | | GENERAL MARKET | | 18 OF 41 | |

TABLE 3 - PART LIST

| Pos. | Molex PN: | Engineering No.: |
|------|------------|------------------|
| 2441 | 2210503046 | E452B3A10K11S0K |
| 2442 | 2210503047 | E452B3A10K11S0L |
| 2443 | 2210503048 | E452B3A10K11S0M |
| 2444 | 2210503049 | E452B3A15011000 |
| 2445 | 2210503050 | E452B3A15011A11 |
| 2446 | 2210503051 | E452B3A15011A12 |
| 2447 | 2210503052 | E452B3A15011A13 |
| 2448 | 2210503053 | E452B3A15011A14 |
| 2449 | 2210503054 | E452B3A15011A15 |
| 2450 | 2210503055 | E452B3A15011A1A |
| 2451 | 2210503056 | E452B3A15011A1B |
| 2452 | 2210503057 | E452B3A15011A1C |
| 2453 | 2210503058 | E452B3A15011A1D |
| 2454 | 2210503059 | E452B3A15011A1E |
| 2455 | 2210503060 | E452B3A15011A1G |
| 2456 | 2210503061 | E452B3A15011A1H |
| 2457 | 2210503062 | E452B3A15011A1K |
| 2458 | 2210503063 | E452B3A15011A1L |
| 2459 | 2210503064 | E452B3A15011A1M |
| 2460 | 2210503065 | E452B3A15011C31 |
| 2461 | 2210503066 | E452B3A15011C32 |
| 2462 | 2210503067 | E452B3A15011C33 |
| 2463 | 2210503068 | E452B3A15011C34 |
| 2464 | 2210503069 | E452B3A15011C35 |
| 2465 | 2210503070 | E452B3A15011C3A |
| 2466 | 2210503071 | E452B3A15011C3B |
| 2467 | 2210503072 | E452B3A15011C3C |
| 2468 | 2210503073 | E452B3A15011C3D |
| 2469 | 2210503074 | E452B3A15011C3E |
| 2470 | 2210503075 | E452B3A15011C3G |
| 2471 | 2210503076 | E452B3A15011C3H |
| 2472 | 2210503077 | E452B3A15011C3K |
| 2473 | 2210503078 | E452B3A15011C3L |
| 2474 | 2210503079 | E452B3A15011C3M |
| 2475 | 2210503080 | E452B3A15011C41 |
| 2476 | 2210503081 | E452B3A15011C42 |
| 2477 | 2210503082 | E452B3A15011C43 |
| 2478 | 2210503083 | E452B3A15011C44 |
| 2479 | 2210503084 | E452B3A15011C45 |
| 2480 | 2210503085 | E452B3A15011C4A |

| Pos. | Molex PN: | Engineering No.: |
|------|------------|------------------|
| 2481 | 2210503086 | E452B3A15011C4B |
| 2482 | 2210503087 | E452B3A15011C4C |
| 2483 | 2210503088 | E452B3A15011C4D |
| 2484 | 2210503089 | E452B3A15011C4E |
| 2485 | 2210503090 | E452B3A15011C4G |
| 2486 | 2210503091 | E452B3A15011C4H |
| 2487 | 2210503092 | E452B3A15011C4K |
| 2488 | 2210503093 | E452B3A15011C4L |
| 2489 | 2210503094 | E452B3A15011C4M |
| 2490 | 2210503099 | E452B3A15011E05 |
| 2491 | N/A | N/A |
| 2492 | N/A | N/A |
| 2493 | N/A | N/A |
| 2494 | N/A | N/A |
| 2495 | 2210503114 | E452B3A15011R05 |
| 2496 | N/A | N/A |
| 2497 | N/A | N/A |
| 2498 | N/A | N/A |
| 2499 | N/A | N/A |
| 2500 | N/A | N/A |
| 2501 | N/A | N/A |
| 2502 | N/A | N/A |
| 2503 | N/A | N/A |
| 2504 | N/A | N/A |
| 2505 | N/A | N/A |
| 2506 | 2210503125 | E452B3A15011R21 |
| 2507 | 2210503126 | E452B3A15011R22 |
| 2508 | 2210503127 | E452B3A15011R23 |
| 2509 | 2210503128 | E452B3A15011R24 |
| 2510 | 2210503129 | E452B3A15011R25 |
| 2511 | 2210503130 | E452B3A15011R2A |
| 2512 | 2210503131 | E452B3A15011R2B |
| 2513 | 2210503132 | E452B3A15011R2C |
| 2514 | 2210503133 | E452B3A15011R2D |
| 2515 | 2210503134 | E452B3A15011R2E |
| 2516 | 2210503135 | E452B3A15011R2G |
| 2517 | 2210503136 | E452B3A15011R2H |
| 2518 | 2210503137 | E452B3A15011R2K |
| 2519 | 2210503138 | E452B3A15011R2L |
| 2520 | 2210503139 | E452B3A15011R2M |

| Pos. | Molex PN: | Engineering No.: |
|------|------------|------------------|
| 2521 | 2210503140 | E452B3A15011S01 |
| 2522 | 2210503141 | E452B3A15011S02 |
| 2523 | 2210503142 | E452B3A15011S03 |
| 2524 | 2210503143 | E452B3A15011S04 |
| 2525 | 2210503144 | E452B3A15011S05 |
| 2526 | 2210503145 | E452B3A15011S0A |
| 2527 | 2210503146 | E452B3A15011S0B |
| 2528 | 2210503147 | E452B3A15011S0C |
| 2529 | 2210503148 | E452B3A15011S0D |
| 2530 | 2210503149 | E452B3A15011S0E |
| 2531 | 2210503150 | E452B3A15011S0G |
| 2532 | 2210503151 | E452B3A15011S0H |
| 2533 | 2210503152 | E452B3A15011S0K |
| 2534 | 2210503153 | E452B3A15011S0L |
| 2535 | 2210503154 | E452B3A15011S0M |
| 2536 | 2210503155 | E452B3A20011000 |
| 2537 | 2210503156 | E452B3A20011A11 |
| 2538 | 2210503157 | E452B3A20011A12 |
| 2539 | 2210503158 | E452B3A20011A13 |
| 2540 | 2210503159 | E452B3A20011A14 |
| 2541 | 2210503160 | E452B3A20011A15 |
| 2542 | 2210503161 | E452B3A20011A1A |
| 2543 | 2210503162 | E452B3A20011A1B |
| 2544 | 2210503163 | E452B3A20011A1C |
| 2545 | 2210503164 | E452B3A20011A1D |
| 2546 | 2210503165 | E452B3A20011A1E |
| 2547 | 2210503166 | E452B3A20011A1G |
| 2548 | 2210503167 | E452B3A20011A1H |
| 2549 | 2210503168 | E452B3A20011A1K |
| 2550 | 2210503169 | E452B3A20011A1L |
| 2551 | 2210503170 | E452B3A20011A1M |
| 2552 | 2210503171 | E452B3A20011C31 |
| 2553 | 2210503172 | E452B3A20011C32 |
| 2554 | 2210503173 | E452B3A20011C33 |
| 2555 | 2210503174 | E452B3A20011C34 |
| 2556 | 2210503175 | E452B3A20011C35 |
| 2557 | 2210503176 | E452B3A20011C3A |
| 2558 | 2210503177 | E452B3A20011C3B |
| 2559 | 2210503178 | E452B3A20011C3C |
| 2560 | 2210503179 | E452B3A20011C3D |

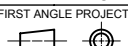
| Pos. | Molex PN: | Engineering No.: |
|------|------------|------------------|
| 2561 | 2210503180 | E452B3A20011C3E |
| 2562 | 2210503181 | E452B3A20011C3G |
| 2563 | 2210503182 | E452B3A20011C3H |
| 2564 | 2210503183 | E452B3A20011C3K |
| 2565 | 2210503184 | E452B3A20011C3L |
| 2566 | 2210503185 | E452B3A20011C3M |
| 2567 | 2210503186 | E452B3A20011C41 |
| 2568 | 2210503187 | E452B3A20011C42 |
| 2569 | 2210503188 | E452B3A20011C43 |
| 2570 | 2210503189 | E452B3A20011C44 |
| 2571 | 2210503190 | E452B3A20011C45 |
| 2572 | 2210503191 | E452B3A20011C4A |
| 2573 | 2210503192 | E452B3A20011C4B |
| 2574 | 2210503193 | E452B3A20011C4C |
| 2575 | 2210503194 | E452B3A20011C4D |
| 2576 | 2210503195 | E452B3A20011C4E |
| 2577 | 2210503196 | E452B3A20011C4G |
| 2578 | 2210503197 | E452B3A20011C4H |
| 2579 | 2210503198 | E452B3A20011C4K |
| 2580 | 2210503199 | E452B3A20011C4L |
| 2581 | 2210503200 | E452B3A20011C4M |
| 2582 | 2210503205 | E452B3A20011E05 |
| 2583 | N/A | N/A |
| 2584 | N/A | N/A |
| 2585 | N/A | N/A |
| 2586 | N/A | N/A |
| 2587 | 2210503220 | E452B3A20011R05 |
| 2588 | N/A | N/A |
| 2589 | N/A | N/A |
| 2590 | N/A | N/A |
| 2591 | N/A | N/A |
| 2592 | N/A | N/A |
| 2593 | N/A | N/A |
| 2594 | N/A | N/A |
| 2595 | N/A | N/A |
| 2596 | N/A | N/A |
| 2597 | N/A | N/A |
| 2598 | 2210503231 | E452B3A20011R21 |
| 2599 | 2210503232 | E452B3A20011R22 |
| 2600 | 2210503233 | E452B3A20011R23 |

| | | | | | | | | | |
|---|--|-------|--|---|--|---------------------------|--|--|--|
| THIS DRAWING CONTAINS INFORMATION THAT IS PROPRIETARY TO MOLEX ELECTRONIC TECHNOLOGIES, LLC AND SHOULD NOT BE USED WITHOUT WRITTEN PERMISSION | | | | | | | | | |
| DIMENSION UNITS | | SCALE | | CURRENT REV DESC: REVISION CREATED FOR REMOVING PRE-RELEASE STAMP | | | |  E452XXXXXXX DIN FORM A EN 175301-803 | |
| mm | | NTS | | | | | | | |
| GENERAL TOLERANCES (UNLESS SPECIFIED) | | | | EC NO: 714567 | | 2022/07/18 | | PRODUCT CUSTOMER DRAWING | |
| | | | | DRWN: SUGEEB | | 2022/07/19 | | | |
| | | | | CHK'D: GGA | | 2022/07/19 | | DOCUMENT NUMBER SD-121050-001 | |
| | | | | APPR: GGA | | 2022/07/19 | | | |
| | | | | INITIAL REVISION: | | 2012/08/27 | | DOC TYPE PSD | |
| | | | | DRWN: JMARSZALEK | | 2012/08/20 | | | |
| | | | | APPR: MDYSZEWSKA | | | | DOC PART 001 | |
| | | | | | | | | | |
| DRAFT WHERE APPLICABLE MUST REMAIN WITHIN DIMENSIONS | | | | FIRST ANGLE PROJECTION | | DRAWING | | REVISION E1 | |
| | | | |  | | SERIES A3-SIZE | | | |
| | | | | | | MATERIAL NUMBER 121050 | | CUSTOMER GENERAL MARKET | |
| | | | | | | | | SHEET NUMBER 19 OF 41 | |

TABLE 3 - PART LIST

| Pos. | Molex PN: | Engineering No.: |
|------|------------|------------------|
| 2601 | 2210503234 | E452B3A20011R24 |
| 2602 | 2210503235 | E452B3A20011R25 |
| 2603 | 2210503236 | E452B3A20011R2A |
| 2604 | 2210503237 | E452B3A20011R2B |
| 2605 | 2210503238 | E452B3A20011R2C |
| 2606 | 2210503239 | E452B3A20011R2D |
| 2607 | 2210503240 | E452B3A20011R2E |
| 2608 | 2210503241 | E452B3A20011R2G |
| 2609 | 2210503242 | E452B3A20011R2H |
| 2610 | 2210503243 | E452B3A20011R2K |
| 2611 | 2210503244 | E452B3A20011R2L |
| 2612 | 2210503245 | E452B3A20011R2M |
| 2613 | 2210503246 | E452B3A20011S01 |
| 2614 | 2210503247 | E452B3A20011S02 |
| 2615 | 2210503248 | E452B3A20011S03 |
| 2616 | 2210503249 | E452B3A20011S04 |
| 2617 | 2210503250 | E452B3A20011S05 |
| 2618 | 2210503251 | E452B3A20011S0A |
| 2619 | 2210503252 | E452B3A20011S0B |
| 2620 | 2210503253 | E452B3A20011S0C |
| 2621 | 2210503254 | E452B3A20011S0D |
| 2622 | 2210503255 | E452B3A20011S0E |
| 2623 | 2210503256 | E452B3A20011S0G |
| 2624 | 2210503257 | E452B3A20011S0H |
| 2625 | 2210503258 | E452B3A20011S0K |
| 2626 | 2210503259 | E452B3A20011S0L |
| 2627 | 2210503260 | E452B3A20011S0M |
| 2628 | 2210503261 | E452B3A30011000 |
| 2629 | 2210503262 | E452B3A30011A11 |
| 2630 | 2210503263 | E452B3A30011A12 |
| 2631 | 2210503264 | E452B3A30011A13 |
| 2632 | 2210503265 | E452B3A30011A14 |
| 2633 | 2210503266 | E452B3A30011A15 |
| 2634 | 2210503267 | E452B3A30011A1A |
| 2635 | 2210503268 | E452B3A30011A1B |
| 2636 | 2210503269 | E452B3A30011A1C |
| 2637 | 2210503270 | E452B3A30011A1D |
| 2638 | 2210503271 | E452B3A30011A1E |
| 2639 | 2210503272 | E452B3A30011A1G |
| 2640 | 2210503273 | E452B3A30011A1H |

| Pos. | Molex PN: | Engineering No.: |
|------|------------|------------------|
| 2641 | 2210503274 | E452B3A30011A1K |
| 2642 | 2210503275 | E452B3A30011A1L |
| 2643 | 2210503276 | E452B3A30011A1M |
| 2644 | 2210503277 | E452B3A30011C31 |
| 2645 | 2210503278 | E452B3A30011C32 |
| 2646 | 2210503279 | E452B3A30011C33 |
| 2647 | 2210503280 | E452B3A30011C34 |
| 2648 | 2210503281 | E452B3A30011C35 |
| 2649 | 2210503282 | E452B3A30011C3A |
| 2650 | 2210503283 | E452B3A30011C3B |
| 2651 | 2210503284 | E452B3A30011C3C |
| 2652 | 2210503285 | E452B3A30011C3D |
| 2653 | 2210503286 | E452B3A30011C3E |
| 2654 | 2210503287 | E452B3A30011C3G |
| 2655 | 2210503288 | E452B3A30011C3H |
| 2656 | 2210503289 | E452B3A30011C3K |
| 2657 | 2210503290 | E452B3A30011C3L |
| 2658 | 2210503291 | E452B3A30011C3M |
| 2659 | 2210503292 | E452B3A30011C41 |
| 2660 | 2210503293 | E452B3A30011C42 |
| 2661 | 2210503294 | E452B3A30011C43 |
| 2662 | 2210503295 | E452B3A30011C44 |
| 2663 | 2210503296 | E452B3A30011C45 |
| 2664 | 2210503297 | E452B3A30011C4A |
| 2665 | 2210503298 | E452B3A30011C4B |
| 2666 | 2210503299 | E452B3A30011C4C |
| 2667 | 2210503300 | E452B3A30011C4D |
| 2668 | 2210503301 | E452B3A30011C4E |
| 2669 | 2210503302 | E452B3A30011C4G |
| 2670 | 2210503303 | E452B3A30011C4K |
| 2671 | 2210503304 | E452B3A30011C4L |
| 2672 | 2210503305 | E452B3A30011C4M |
| 2673 | 2210503310 | E452B3A30011E05 |
| 2674 | N/A | N/A |
| 2675 | N/A | N/A |
| 2676 | N/A | N/A |
| 2677 | N/A | N/A |
| 2678 | 2210503325 | E452B3A30011R05 |
| 2679 | N/A | N/A |
| 2680 | N/A | N/A |

| Pos. | Molex PN: | Engineering No.: |
|------|------------|------------------|
| 2681 | N/A | N/A |
| 2682 | N/A | N/A |
| 2683 | N/A | N/A |
| 2684 | N/A | N/A |
| 2685 | N/A | N/A |
| 2686 | N/A | N/A |
| 2687 | N/A | N/A |
| 2688 | N/A | N/A |
| 2689 | 2210503336 | E452B3A30011R21 |
| 2690 | 2210503337 | E452B3A30011R22 |
| 2691 | 2210503338 | E452B3A30011R23 |
| 2692 | 2210503339 | E452B3A30011R24 |
| 2693 | 2210503340 | E452B3A30011R25 |
| 2694 | 2210503341 | E452B3A30011R2A |
| 2695 | 2210503342 | E452B3A30011R2B |
| 2696 | 2210503343 | E452B3A30011R2C |
| 2697 | 2210503344 | E452B3A30011R2D |
| 2698 | 2210503345 | E452B3A30011R2E |
| 2699 | 2210503346 | E452B3A30011R2G |
| 2700 | 2210503347 | E452B3A30011R2H |
| 2701 | 2210503348 | E452B3A30011R2K |
| 2702 | 2210503349 | E452B3A30011R2L |
| 2703 | 2210503350 | E452B3A30011R2M |
| 2704 | 2210503351 | E452B3A30011S01 |
| 2705 | 2210503352 | E452B3A30011S02 |
| 2706 | 2210503353 | E452B3A30011S03 |
| 2707 | 2210503354 | E452B3A30011S04 |
| 2708 | 2210503355 | E452B3A30011S05 |
| 2709 | 2210503356 | E452B3A30011S0A |
| 2710 | 2210503357 | E452B3A30011S0B |
| 2711 | 2210503358 | E452B3A30011S0C |
| 2712 | 2210503359 | E452B3A30011S0D |
| 2713 | 2210503360 | E452B3A30011S0E |
| 2714 | 2210503361 | E452B3A30011S0G |
| 2715 | 2210503362 | E452B3A30011S0K |
| 2716 | 2210503363 | E452B3A30011S0L |
| 2717 | 2210503364 | E452B3A30011S0M |
| 2718 | 2210503365 | E452B3A50011000 |
| 2719 | 2210503366 | E452B3A50011A11 |
| 2720 | 2210503367 | E452B3A50011A12 |

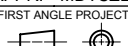
| Pos. | Molex PN: | Engineering No.: |
|------|------------|------------------|
| 2721 | 2210503368 | E452B3A50011A13 |
| 2722 | 2210503369 | E452B3A50011A14 |
| 2723 | 2210503370 | E452B3A50011A15 |
| 2724 | 2210503371 | E452B3A50011A1A |
| 2725 | 2210503372 | E452B3A50011A1B |
| 2726 | 2210503373 | E452B3A50011A1C |
| 2727 | 2210503374 | E452B3A50011A1D |
| 2728 | 2210503375 | E452B3A50011A1E |
| 2729 | 2210503376 | E452B3A50011A1G |
| 2730 | 2210503377 | E452B3A50011A1H |
| 2731 | 2210503378 | E452B3A50011A1K |
| 2732 | 2210503379 | E452B3A50011A1L |
| 2733 | 2210503380 | E452B3A50011A1M |
| 2734 | 2210503381 | E452B3A50011C31 |
| 2735 | 2210503382 | E452B3A50011C32 |
| 2736 | 2210503383 | E452B3A50011C33 |
| 2737 | 2210503384 | E452B3A50011C34 |
| 2738 | 2210503385 | E452B3A50011C35 |
| 2739 | 2210503386 | E452B3A50011C3A |
| 2740 | 2210503387 | E452B3A50011C3B |
| 2741 | 2210503388 | E452B3A50011C3C |
| 2742 | 2210503389 | E452B3A50011C3D |
| 2743 | 2210503390 | E452B3A50011C3E |
| 2744 | 2210503391 | E452B3A50011C3G |
| 2745 | 2210503392 | E452B3A50011C3H |
| 2746 | 2210503393 | E452B3A50011C3K |
| 2747 | 2210503394 | E452B3A50011C3L |
| 2748 | 2210503395 | E452B3A50011C3M |
| 2749 | 2210503396 | E452B3A50011C41 |
| 2750 | 2210503397 | E452B3A50011C42 |
| 2751 | 2210503398 | E452B3A50011C43 |
| 2752 | 2210503399 | E452B3A50011C44 |
| 2753 | 2210503400 | E452B3A50011C45 |
| 2754 | 2210503401 | E452B3A50011C4A |
| 2755 | 2210503402 | E452B3A50011C4B |
| 2756 | 2210503403 | E452B3A50011C4C |
| 2757 | 2210503404 | E452B3A50011C4D |
| 2758 | 2210503405 | E452B3A50011C4E |
| 2759 | 2210503406 | E452B3A50011C4G |
| 2760 | 2210503407 | E452B3A50011C4K |

| | | | | | | | | | |
|---|--|----------|--|---|--|--------------|--|---|--|
| THIS DRAWING CONTAINS INFORMATION THAT IS PROPRIETARY TO MOLEX ELECTRONIC TECHNOLOGIES, LLC AND SHOULD NOT BE USED WITHOUT WRITTEN PERMISSION | | | | | | | | | |
| DIMENSION UNITS | | SCALE | | CURRENT REV DESC: REVISION CREATED FOR REMOVING PRE-RELEASE STAMP | | | |  E452XXXXXXXXXX DIN FORM A EN 175301-803 | |
| mm | | NTS | | | | | | | |
| GENERAL TOLERANCES (UNLESS SPECIFIED) | | | | | | | | | |
| | | MM | | INCH | | | | | |
| 4 PLACES | | ± | | ± | | | | | |
| 3 PLACES | | ± | | ± | | | | | |
| 2 PLACES | | ± | | ± | | | | | |
| 1 PLACE | | ± | | ± | | | | | |
| 0 PLACES | | ± | | ± | | | | | |
| ANGULAR TOL | | ± ° | | | | | | | |
| DRAFT WHERE APPLICABLE MUST REMAIN WITHIN DIMENSIONS | | | | FIRST ANGLE PROJECTION | | DRAWING | | SERIES | |
| | | | |  | | A3-SIZE | | 121050 | |
| DOCUMENT STATUS | | | | P1 | | RELEASE DATE | | 2022/07/19 09:04:35 | |
| DOCUMENT NUMBER | | DOC TYPE | | DOC PART | | REVISION | | | |
| SD-121050-001 | | PSD | | 001 | | E1 | | | |
| MATERIAL NUMBER | | | | CUSTOMER | | SHEET NUMBER | | | |
| SEE TABLE | | | | GENERAL MARKET | | 20 OF 41 | | | |

TABLE 3 - PART LIST

| Pos. | Molex PN: | Engineering No.: |
|------|------------|------------------|
| 2761 | 2210503408 | E452B3A50011C4L |
| 2762 | 2210503409 | E452B3A50011C4M |
| 2763 | 2210503414 | E452B3A50011E05 |
| 2764 | N/A | N/A |
| 2765 | N/A | N/A |
| 2766 | N/A | N/A |
| 2767 | N/A | N/A |
| 2768 | 2210503429 | E452B3A50011R05 |
| 2769 | N/A | N/A |
| 2770 | N/A | N/A |
| 2771 | N/A | N/A |
| 2772 | N/A | N/A |
| 2773 | N/A | N/A |
| 2774 | N/A | N/A |
| 2775 | N/A | N/A |
| 2776 | N/A | N/A |
| 2777 | N/A | N/A |
| 2778 | N/A | N/A |
| 2779 | 2210503440 | E452B3A50011R21 |
| 2780 | 2210503441 | E452B3A50011R22 |
| 2781 | 2210503442 | E452B3A50011R23 |
| 2782 | 2210503443 | E452B3A50011R24 |
| 2783 | 2210503444 | E452B3A50011R25 |
| 2784 | 2210503445 | E452B3A50011R2A |
| 2785 | 2210503446 | E452B3A50011R2B |
| 2786 | 2210503447 | E452B3A50011R2C |
| 2787 | 2210503448 | E452B3A50011R2D |
| 2788 | 2210503449 | E452B3A50011R2E |
| 2789 | 2210503450 | E452B3A50011R2G |
| 2790 | 2210503451 | E452B3A50011R2H |
| 2791 | 2210503452 | E452B3A50011R2K |
| 2792 | 2210503453 | E452B3A50011R2L |
| 2793 | 2210503454 | E452B3A50011R2M |
| 2794 | 2210503455 | E452B3A50011S01 |
| 2795 | 2210503456 | E452B3A50011S02 |
| 2796 | 2210503457 | E452B3A50011S03 |
| 2797 | 2210503458 | E452B3A50011S04 |
| 2798 | 2210503459 | E452B3A50011S05 |
| 2799 | 2210503460 | E452B3A50011S0A |
| 2800 | 2210503461 | E452B3A50011S0B |

| Pos. | Molex PN: | Engineering No.: |
|------|------------|------------------|
| 2801 | 2210503462 | E452B3A50011S0C |
| 2802 | 2210503463 | E452B3A50011S0D |
| 2803 | 2210503464 | E452B3A50011S0E |
| 2804 | 2210503465 | E452B3A50011S0G |
| 2805 | 2210503466 | E452B3A50011S0H |
| 2806 | 2210503467 | E452B3A50011S0K |
| 2807 | 2210503468 | E452B3A50011S0L |
| 2808 | 2210503469 | E452B3A50011S0M |
| 2809 | 2210503470 | E452I2N20011A11 |
| 2810 | 2210503471 | E452I2N20011A12 |
| 2811 | 2210503472 | E452I2N20011A13 |
| 2812 | 2210503473 | E452I2N20011A14 |
| 2813 | 2210503474 | E452I2N20011A15 |
| 2814 | 2210503475 | E452I2N20011A1A |
| 2815 | 2210503476 | E452I2N20011A1B |
| 2816 | 2210503477 | E452I2N20011A1C |
| 2817 | 2210503478 | E452I2N20011A1D |
| 2818 | 2210503479 | E452I2N20011A1E |
| 2819 | 2210503480 | E452I2N20011A1G |
| 2820 | 2210503481 | E452I2N20011A1H |
| 2821 | 2210503482 | E452I2N20011A1K |
| 2822 | 2210503483 | E452I2N20011A1L |
| 2823 | 2210503484 | E452I2N20011A1M |
| 2824 | 2210503485 | E452I2N20011C31 |
| 2825 | 2210503486 | E452I2N20011C32 |
| 2826 | 2210503487 | E452I2N20011C33 |
| 2827 | 2210503488 | E452I2N20011C34 |
| 2828 | 2210503489 | E452I2N20011C35 |
| 2829 | 2210503490 | E452I2N20011C3A |
| 2830 | 2210503491 | E452I2N20011C3B |
| 2831 | 2210503492 | E452I2N20011C3C |
| 2832 | 2210503493 | E452I2N20011C3D |
| 2833 | 2210503494 | E452I2N20011C3E |
| 2834 | 2210503495 | E452I2N20011C3G |
| 2835 | 2210503497 | E452I2N20011C3K |
| 2836 | 2210503498 | E452I2N20011C3L |
| 2837 | 2210503499 | E452I2N20011C3M |
| 2838 | 2210503501 | E452I2N10011000 |
| 2839 | 2210503502 | E452I2N10011A11 |
| 2840 | 2210503503 | E452I2N10011A12 |

| Pos. | Molex PN: | Engineering No.: |
|------|------------|------------------|
| 2841 | 2210503504 | E452I2N10011A13 |
| 2842 | 2210503505 | E452I2N10011A14 |
| 2843 | 2210503506 | E452I2N10011A15 |
| 2844 | 2210503507 | E452I2N10011A1A |
| 2845 | 2210503508 | E452I2N10011A1B |
| 2846 | 2210503509 | E452I2N10011A1C |
| 2847 | 2210503510 | E452I2N10011A1D |
| 2848 | 2210503511 | E452I2N10011A1E |
| 2849 | 2210503512 | E452I2N10011A1G |
| 2850 | 2210503513 | E452I2N10011A1H |
| 2851 | 2210503514 | E452I2N10011A1K |
| 2852 | 2210503515 | E452I2N10011A1L |
| 2853 | 2210503516 | E452I2N10011A1M |
| 2854 | 2210503517 | E452I2N10011C31 |
| 2855 | 2210503518 | E452I2N10011C32 |
| 2856 | 2210503519 | E452I2N10011C33 |
| 2857 | 2210503520 | E452I2N10011C34 |
| 2858 | 2210503521 | E452I2N10011C35 |
| 2859 | 2210503522 | E452I2N10011C3A |
| 2860 | 2210503523 | E452I2N10011C3B |
| 2861 | 2210503524 | E452I2N10011C3C |
| 2862 | 2210503525 | E452I2N10011C3D |
| 2863 | 2210503526 | E452I2N10011C3E |
| 2864 | 2210503527 | E452I2N10011C3G |
| 2865 | 2210503528 | E452I2N10011C3H |
| 2866 | 2210503529 | E452I2N10011C3K |
| 2867 | 2210503530 | E452I2N10011C3L |
| 2868 | 2210503531 | E452I2N10011C3M |
| 2869 | 2210503532 | E452I2N10011C41 |
| 2870 | 2210503533 | E452I2N10011C43 |
| 2871 | 2210503534 | E452I2N10011C44 |
| 2872 | 2210503535 | E452I2N10011C45 |
| 2873 | 2210503536 | E452I2N10011C4A |
| 2874 | 2210503537 | E452I2N10011C4B |
| 2875 | 2210503538 | E452I2N10011C4C |
| 2876 | 2210503539 | E452I2N10011C4D |
| 2877 | 2210503540 | E452I2N10011C4E |
| 2878 | 2210503541 | E452I2N10011C4G |
| 2879 | 2210503542 | E452I2N10011C4K |
| 2880 | 2210503543 | E452I2N10011C4L |

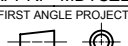
| Pos. | Molex PN: | Engineering No.: |
|------|------------|------------------|
| 2881 | 2210503544 | E452I2N10011C4M |
| 2882 | 2210503549 | E452I2N10011E05 |
| 2883 | N/A | N/A |
| 2884 | N/A | N/A |
| 2885 | N/A | N/A |
| 2886 | N/A | N/A |
| 2887 | 2210503564 | E452I2N10011R05 |
| 2888 | N/A | N/A |
| 2889 | N/A | N/A |
| 2890 | N/A | N/A |
| 2891 | N/A | N/A |
| 2892 | N/A | N/A |
| 2893 | N/A | N/A |
| 2894 | N/A | N/A |
| 2895 | N/A | N/A |
| 2896 | N/A | N/A |
| 2897 | N/A | N/A |
| 2898 | 2210503575 | E452I2N10011R21 |
| 2899 | 2210503576 | E452I2N10011R22 |
| 2900 | 2210503577 | E452I2N10011R23 |
| 2901 | 2210503578 | E452I2N10011R24 |
| 2902 | 2210503579 | E452I2N10011R25 |
| 2903 | 2210503580 | E452I2N10011R2A |
| 2904 | 2210503581 | E452I2N10011R2B |
| 2905 | 2210503582 | E452I2N10011R2C |
| 2906 | 2210503583 | E452I2N10011R2D |
| 2907 | 2210503584 | E452I2N10011R2E |
| 2908 | 2210503585 | E452I2N10011R2G |
| 2909 | 2210503586 | E452I2N10011R2H |
| 2910 | 2210503587 | E452I2N10011R2K |
| 2911 | 2210503588 | E452I2N10011R2L |
| 2912 | 2210503589 | E452I2N10011R2M |
| 2913 | 2210503590 | E452I2N10011S01 |
| 2914 | 2210503591 | E452I2N10011S02 |
| 2915 | 2210503592 | E452I2N10011S03 |
| 2916 | 2210503593 | E452I2N10011S04 |
| 2917 | 2210503594 | E452I2N10011S05 |
| 2918 | 2210503595 | E452I2N10011S0A |
| 2919 | 2210503596 | E452I2N10011S0B |
| 2920 | 2210503597 | E452I2N10011S0C |

| | | | | | | | | | |
|---|--|-------|--|---|--|------------------------|--|---|--|
| THIS DRAWING CONTAINS INFORMATION THAT IS PROPRIETARY TO MOLEX ELECTRONIC TECHNOLOGIES, LLC AND SHOULD NOT BE USED WITHOUT WRITTEN PERMISSION | | | | | | | | | |
| DIMENSION UNITS | | SCALE | | CURRENT REV DESC: REVISION CREATED FOR REMOVING PRE-RELEASE STAMP | | | |  E452XXXXXXXXXX DIN FORM A EN 175301-803 | |
| mm | | NTS | | | | | | | |
| GENERAL TOLERANCES (UNLESS SPECIFIED) | | | | EC NO: 714567 | | 2022/07/18 | | PRODUCT CUSTOMER DRAWING | |
| | | | | DRWN: SUGEEB | | 2022/07/19 | | | |
| | | | | CHK'D: GGA | | 2022/07/19 | | DOCUMENT NUMBER | |
| | | | | APPR: GGA | | 2022/07/19 | | | |
| | | | | INITIAL REVISION: | | | | SD-121050-001 | |
| | | | | DRWN: JMARSZALEK | | 2012/08/27 | | | |
| | | | | APPR: MDYSZEWSKA | | 2012/08/20 | | DOC TYPE | |
| | | | | DRAFT WHERE APPLICABLE MUST REMAIN WITHIN DIMENSIONS | | FIRST ANGLE PROJECTION | | DOC PART | |
| | | | | | | DRAWING | | REVISION | |
| | | | | | | SERIES | | PSD | |
| | | | | | | MATERIAL NUMBER | | 001 | |
| | | | | | | CUSTOMER | | E1 | |
| | | | | | | SHEET NUMBER | | 21 OF 41 | |

TABLE 3 - PART LIST

| Pos. | Molex PN: | Engineering No.: |
|------|------------|------------------|
| 2921 | 2210503598 | E452I2N10011S0D |
| 2922 | 2210503599 | E452I2N10011S0E |
| 2923 | 2210503600 | E452I2N10011S0G |
| 2924 | 2210503601 | E452I2N10011S0H |
| 2925 | 2210503602 | E452I2N10011S0K |
| 2926 | 2210503603 | E452I2N10011S0L |
| 2927 | 2210503604 | E452I2N10011S0M |
| 2928 | 2210503605 | E452I2N10K11000 |
| 2929 | 2210503606 | E452I2N10K11A11 |
| 2930 | 2210503607 | E452I2N10K11A12 |
| 2931 | 2210503608 | E452I2N10K11A13 |
| 2932 | 2210503609 | E452I2N10K11A14 |
| 2933 | 2210503610 | E452I2N10K11A15 |
| 2934 | 2210503611 | E452I2N10K11A1A |
| 2935 | 2210503612 | E452I2N10K11A1B |
| 2936 | 2210503613 | E452I2N10K11A1C |
| 2937 | 2210503614 | E452I2N10K11A1D |
| 2938 | 2210503615 | E452I2N10K11A1E |
| 2939 | 2210503616 | E452I2N10K11A1G |
| 2940 | 2210503617 | E452I2N10K11A1H |
| 2941 | 2210503618 | E452I2N10K11A1K |
| 2942 | 2210503619 | E452I2N10K11A1L |
| 2943 | 2210503620 | E452I2N10K11A1M |
| 2944 | 2210503621 | E452I2N10K11C31 |
| 2945 | 2210503622 | E452I2N10K11C32 |
| 2946 | 2210503623 | E452I2N10K11C33 |
| 2947 | 2210503624 | E452I2N10K11C34 |
| 2948 | 2210503625 | E452I2N10K11C35 |
| 2949 | 2210503626 | E452I2N10K11C3A |
| 2950 | 2210503627 | E452I2N10K11C3B |
| 2951 | 2210503628 | E452I2N10K11C3C |
| 2952 | 2210503629 | E452I2N10K11C3D |
| 2953 | 2210503630 | E452I2N10K11C3E |
| 2954 | 2210503631 | E452I2N10K11C3G |
| 2955 | 2210503632 | E452I2N10K11C3H |
| 2956 | 2210503633 | E452I2N10K11C3K |
| 2957 | 2210503634 | E452I2N10K11C3L |
| 2958 | 2210503635 | E452I2N10K11C3M |
| 2959 | 2210503636 | E452I2N10K11C41 |
| 2960 | 2210503637 | E452I2N10K11C42 |

| Pos. | Molex PN: | Engineering No.: |
|------|------------|------------------|
| 2961 | 2210503638 | E452I2N10K11C43 |
| 2962 | 2210503639 | E452I2N10K11C44 |
| 2963 | 2210503640 | E452I2N10K11C45 |
| 2964 | 2210503641 | E452I2N10K11C4A |
| 2965 | 2210503642 | E452I2N10K11C4B |
| 2966 | 2210503643 | E452I2N10K11C4C |
| 2967 | 2210503644 | E452I2N10K11C4D |
| 2968 | 2210503645 | E452I2N10K11C4E |
| 2969 | 2210503646 | E452I2N10K11C4G |
| 2970 | 2210503647 | E452I2N10K11C4K |
| 2971 | 2210503648 | E452I2N10K11C4L |
| 2972 | 2210503649 | E452I2N10K11C4M |
| 2973 | 2210503654 | E452I2N10K11E05 |
| 2974 | N/A | N/A |
| 2975 | N/A | N/A |
| 2976 | N/A | N/A |
| 2977 | N/A | N/A |
| 2978 | 2210503669 | E452I2N10K11R05 |
| 2979 | N/A | N/A |
| 2980 | N/A | N/A |
| 2981 | N/A | N/A |
| 2982 | N/A | N/A |
| 2983 | N/A | N/A |
| 2984 | N/A | N/A |
| 2985 | N/A | N/A |
| 2986 | N/A | N/A |
| 2987 | N/A | N/A |
| 2988 | N/A | N/A |
| 2989 | 2210503680 | E452I2N10K11R21 |
| 2990 | 2210503681 | E452I2N10K11R22 |
| 2991 | 2210503682 | E452I2N10K11R23 |
| 2992 | 2210503683 | E452I2N10K11R24 |
| 2993 | 2210503684 | E452I2N10K11R25 |
| 2994 | 2210503685 | E452I2N10K11R2A |
| 2995 | 2210503686 | E452I2N10K11R2B |
| 2996 | 2210503687 | E452I2N10K11R2C |
| 2997 | 2210503688 | E452I2N10K11R2D |
| 2998 | 2210503689 | E452I2N10K11R2E |
| 2999 | 2210503690 | E452I2N10K11R2G |
| 3000 | 2210503691 | E452I2N10K11R2H |

| Pos. | Molex PN: | Engineering No.: |
|------|------------|------------------|
| 3001 | 2210503692 | E452I2N10K11R2K |
| 3002 | 2210503693 | E452I2N10K11R2L |
| 3003 | 2210503694 | E452I2N10K11R2M |
| 3004 | 2210503695 | E452I2N10K11S01 |
| 3005 | 2210503696 | E452I2N10K11S02 |
| 3006 | 2210503697 | E452I2N10K11S03 |
| 3007 | 2210503698 | E452I2N10K11S04 |
| 3008 | 2210503699 | E452I2N10K11S05 |
| 3009 | 2210503700 | E452I2N10K11S0A |
| 3010 | 2210503701 | E452I2N10K11S0B |
| 3011 | 2210503702 | E452I2N10K11S0C |
| 3012 | 2210503703 | E452I2N10K11S0D |
| 3013 | 2210503704 | E452I2N10K11S0E |
| 3014 | 2210503705 | E452I2N10K11S0G |
| 3015 | 2210503706 | E452I2N10K11S0H |
| 3016 | 2210503707 | E452I2N10K11S0K |
| 3017 | 2210503708 | E452I2N10K11S0L |
| 3018 | 2210503709 | E452I2N10K11S0M |
| 3019 | 2210503710 | E452I2N15011000 |
| 3020 | 2210503711 | E452I2N15011A11 |
| 3021 | 2210503712 | E452I2N15011A12 |
| 3022 | 2210503713 | E452I2N15011A13 |
| 3023 | 2210503714 | E452I2N15011A14 |
| 3024 | 2210503715 | E452I2N15011A15 |
| 3025 | 2210503716 | E452I2N15011A1A |
| 3026 | 2210503717 | E452I2N15011A1B |
| 3027 | 2210503718 | E452I2N15011A1C |
| 3028 | 2210503719 | E452I2N15011A1D |
| 3029 | 2210503720 | E452I2N15011A1E |
| 3030 | 2210503721 | E452I2N15011A1G |
| 3031 | 2210503722 | E452I2N15011A1H |
| 3032 | 2210503723 | E452I2N15011A1K |
| 3033 | 2210503724 | E452I2N15011A1L |
| 3034 | 2210503725 | E452I2N15011A1M |
| 3035 | 2210503726 | E452I2N15011C31 |
| 3036 | 2210503727 | E452I2N15011C32 |
| 3037 | 2210503728 | E452I2N15011C33 |
| 3038 | 2210503729 | E452I2N15011C34 |
| 3039 | 2210503730 | E452I2N15011C35 |
| 3040 | 2210503731 | E452I2N15011C3A |

| Pos. | Molex PN: | Engineering No.: |
|------|------------|------------------|
| 3041 | 2210503732 | E452I2N15011C3B |
| 3042 | 2210503733 | E452I2N15011C3C |
| 3043 | 2210503734 | E452I2N15011C3D |
| 3044 | 2210503735 | E452I2N15011C3E |
| 3045 | 2210503736 | E452I2N15011C3G |
| 3046 | 2210503737 | E452I2N15011C3K |
| 3047 | 2210503738 | E452I2N15011C3L |
| 3048 | 2210503739 | E452I2N15011C3M |
| 3049 | 2210503740 | E452I2N15011C41 |
| 3050 | 2210503741 | E452I2N15011C42 |
| 3051 | 2210503742 | E452I2N15011C43 |
| 3052 | 2210503743 | E452I2N15011C44 |
| 3053 | 2210503744 | E452I2N15011C45 |
| 3054 | 2210503745 | E452I2N15011C4A |
| 3055 | 2210503746 | E452I2N15011C4B |
| 3056 | 2210503747 | E452I2N15011C4C |
| 3057 | 2210503748 | E452I2N15011C4D |
| 3058 | 2210503749 | E452I2N15011C4E |
| 3059 | 2210503750 | E452I2N15011C4G |
| 3060 | 2210503751 | E452I2N15011C4H |
| 3061 | 2210503752 | E452I2N15011C4K |
| 3062 | 2210503753 | E452I2N15011C4L |
| 3063 | 2210503754 | E452I2N15011C4M |
| 3064 | 2210503759 | E452I2N15011E05 |
| 3065 | N/A | N/A |
| 3066 | N/A | N/A |
| 3067 | N/A | N/A |
| 3068 | N/A | N/A |
| 3069 | 2210503774 | E452I2N15011R05 |
| 3070 | N/A | N/A |
| 3071 | N/A | N/A |
| 3072 | N/A | N/A |
| 3073 | N/A | N/A |
| 3074 | N/A | N/A |
| 3075 | N/A | N/A |
| 3076 | N/A | N/A |
| 3077 | N/A | N/A |
| 3078 | N/A | N/A |
| 3079 | N/A | N/A |
| 3080 | 2210503785 | E452I2N15011R21 |

| | | | | | | | | | | | |
|---|--|-------|--|---|--|---------|--|----------------|--|---|--|
| THIS DRAWING CONTAINS INFORMATION THAT IS PROPRIETARY TO MOLEX ELECTRONIC TECHNOLOGIES, LLC AND SHOULD NOT BE USED WITHOUT WRITTEN PERMISSION | | | | | | | | | | | |
| DIMENSION UNITS | | SCALE | | CURRENT REV DESC: REVISION CREATED FOR REMOVING PRE-RELEASE STAMP | | | | | |  E452XXXXXXXXXX DIN FORM A EN 175301-803 | |
| mm | | NTS | | | | | | | | | |
| GENERAL TOLERANCES (UNLESS SPECIFIED) | | | | | | | | | | | |
| | | MM | | INCH | | | | | | | |
| 4 PLACES | | ± | | ± | | | | | | | |
| 3 PLACES | | ± | | ± | | | | | | | |
| 2 PLACES | | ± | | ± | | | | | | | |
| 1 PLACE | | ± | | ± | | | | | | | |
| 0 PLACES | | ± | | ± | | | | | | | |
| ANGULAR TOL | | ± | | ° | | | | | | | |
| DRAFT WHERE APPLICABLE MUST REMAIN WITHIN DIMENSIONS | | | | FIRST ANGLE PROJECTION | | DRAWING | | SERIES | | MATERIAL NUMBER | |
| | | | |  | | A3-SIZE | | 121050 | | SEE TABLE | |
| | | | | | | | | CUSTOMER | | SHEET NUMBER | |
| | | | | | | | | GENERAL MARKET | | 22 OF 41 | |

TABLE 3 - PART LIST

| Pos. | Molex PN: | Engineering No.: |
|------|------------|------------------|
| 3081 | 2210503786 | E452I2N15011R22 |
| 3082 | 2210503787 | E452I2N15011R23 |
| 3083 | 2210503788 | E452I2N15011R24 |
| 3084 | 2210503789 | E452I2N15011R25 |
| 3085 | 2210503790 | E452I2N15011R2A |
| 3086 | 2210503791 | E452I2N15011R2B |
| 3087 | 2210503792 | E452I2N15011R2C |
| 3088 | 2210503793 | E452I2N15011R2D |
| 3089 | 2210503794 | E452I2N15011R2E |
| 3090 | 2210503795 | E452I2N15011R2G |
| 3091 | 2210503796 | E452I2N15011R2H |
| 3092 | 2210503797 | E452I2N15011R2K |
| 3093 | 2210503798 | E452I2N15011R2L |
| 3094 | 2210503799 | E452I2N15011R2M |
| 3095 | 2210503800 | E452I2N15011S01 |
| 3096 | 2210503801 | E452I2N15011S02 |
| 3097 | 2210503802 | E452I2N15011S03 |
| 3098 | 2210503803 | E452I2N15011S04 |
| 3099 | 2210503804 | E452I2N15011S05 |
| 3100 | 2210503805 | E452I2N15011S0A |
| 3101 | 2210503806 | E452I2N15011S0B |
| 3102 | 2210503807 | E452I2N15011S0C |
| 3103 | 2210503808 | E452I2N15011S0D |
| 3104 | 2210503809 | E452I2N15011S0E |
| 3105 | 2210503810 | E452I2N15011S0G |
| 3106 | 2210503811 | E452I2N15011S0H |
| 3107 | 2210503812 | E452I2N15011S0K |
| 3108 | 2210503813 | E452I2N15011S0L |
| 3109 | 2210503814 | E452I2N15011S0M |
| 3110 | 2210503815 | E452I2N20011000 |
| 3111 | 2210503816 | E452I2N20011C41 |
| 3112 | 2210503817 | E452I2N20011C42 |
| 3113 | 2210503818 | E452I2N20011C43 |
| 3114 | 2210503819 | E452I2N20011C44 |
| 3115 | 2210503820 | E452I2N20011C45 |
| 3116 | 2210503821 | E452I2N20011C4A |
| 3117 | 2210503822 | E452I2N20011C4B |
| 3118 | 2210503823 | E452I2N20011C4C |
| 3119 | 2210503824 | E452I2N20011C4D |
| 3120 | 2210503825 | E452I2N20011C4E |

| Pos. | Molex PN: | Engineering No.: |
|------|------------|------------------|
| 3121 | 2210503826 | E452I2N20011C4G |
| 3122 | 2210503827 | E452I2N20011C4K |
| 3123 | 2210503828 | E452I2N20011C4L |
| 3124 | 2210503829 | E452I2N20011C4M |
| 3125 | 2210503830 | E452I2N20011C4N |
| 3126 | N/A | N/A |
| 3127 | N/A | N/A |
| 3128 | N/A | N/A |
| 3129 | 2210503833 | E452I2N20011E05 |
| 3130 | N/A | N/A |
| 3131 | N/A | N/A |
| 3132 | N/A | N/A |
| 3133 | N/A | N/A |
| 3134 | N/A | N/A |
| 3135 | N/A | N/A |
| 3136 | N/A | N/A |
| 3137 | N/A | N/A |
| 3138 | N/A | N/A |
| 3139 | N/A | N/A |
| 3140 | 2210503836 | E452I2N20011R21 |
| 3141 | 2210503837 | E452I2N20011R22 |
| 3142 | 2210503838 | E452I2N20011R23 |
| 3143 | 2210503839 | E452I2N20011R24 |
| 3144 | 2210503840 | E452I2N20011R25 |
| 3145 | 2210503841 | E452I2N20011R2A |
| 3146 | 2210503842 | E452I2N20011R2B |
| 3147 | 2210503843 | E452I2N20011R2C |
| 3148 | 2210503844 | E452I2N20011R2D |
| 3149 | 2210503845 | E452I2N20011R2E |
| 3150 | 2210503846 | E452I2N20011R2G |
| 3151 | 2210503847 | E452I2N20011R2H |
| 3152 | 2210503848 | E452I2N20011R2K |
| 3153 | 2210503849 | E452I2N20011R2L |
| 3154 | 2210503850 | E452I2N20011R2M |
| 3155 | 2210503851 | E452I2N20011S01 |
| 3156 | 2210503852 | E452I2N20011S02 |
| 3157 | 2210503853 | E452I2N20011S03 |
| 3158 | 2210503854 | E452I2N20011S04 |
| 3159 | 2210503855 | E452I2N20011S05 |
| 3160 | 2210503856 | E452I2N20011S0A |

| Pos. | Molex PN: | Engineering No.: |
|------|------------|------------------|
| 3161 | 2210503857 | E452I2N20011S0B |
| 3162 | 2210503858 | E452I2N20011S0C |
| 3163 | 2210503859 | E452I2N20011S0D |
| 3164 | 2210503860 | E452I2N20011S0E |
| 3165 | 2210503861 | E452I2N20011S0G |
| 3166 | 2210503862 | E452I2N20011S0H |
| 3167 | 2210503863 | E452I2N20011S0I |
| 3168 | 2210503864 | E452I2N20011S0J |
| 3169 | 2210503865 | E452I2N20011S0K |
| 3170 | 2210503866 | E452I2N20011S0L |
| 3171 | 2210503867 | E452I2N20011S0M |
| 3172 | 2210503868 | E452I2N30011000 |
| 3173 | 2210503869 | E452I2N30011A11 |
| 3174 | 2210503870 | E452I2N30011A12 |
| 3175 | 2210503871 | E452I2N30011A13 |
| 3176 | 2210503872 | E452I2N30011A14 |
| 3177 | 2210503873 | E452I2N30011A15 |
| 3178 | 2210503874 | E452I2N30011A1A |
| 3179 | 2210503875 | E452I2N30011A1B |
| 3180 | 2210503876 | E452I2N30011A1C |
| 3181 | 2210503877 | E452I2N30011A1D |
| 3182 | 2210503878 | E452I2N30011A1E |
| 3183 | 2210503879 | E452I2N30011A1G |
| 3184 | 2210503880 | E452I2N30011A1H |
| 3185 | 2210503881 | E452I2N30011A1K |
| 3186 | 2210503882 | E452I2N30011A1L |
| 3187 | 2210503883 | E452I2N30011A1M |
| 3188 | 2210503884 | E452I2N30011C31 |
| 3189 | 2210503885 | E452I2N30011C33 |
| 3190 | 2210503886 | E452I2N30011C34 |
| 3191 | 2210503887 | E452I2N30011C35 |
| 3192 | 2210503888 | E452I2N30011C3A |
| 3193 | 2210503889 | E452I2N30011C3B |
| 3194 | 2210503890 | E452I2N30011C3C |
| 3195 | 2210503891 | E452I2N30011C3D |
| 3196 | 2210503892 | E452I2N30011C3E |
| 3197 | 2210503893 | E452I2N30011C3G |
| 3198 | 2210503894 | E452I2N30011C3K |
| 3199 | 2210503895 | E452I2N30011C3L |
| 3200 | 2210503896 | E452I2N30011C3M |

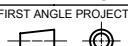
| Pos. | Molex PN: | Engineering No.: |
|------|------------|------------------|
| 3201 | 2210503897 | E452I2N30011C43 |
| 3202 | 2210503898 | E452I2N30011C44 |
| 3203 | 2210503899 | E452I2N30011C45 |
| 3204 | 2210503900 | E452I2N30011C4A |
| 3205 | 2210503901 | E452I2N30011C4B |
| 3206 | 2210503902 | E452I2N30011C4C |
| 3207 | 2210503903 | E452I2N30011C4D |
| 3208 | 2210503904 | E452I2N30011C4E |
| 3209 | 2210503905 | E452I2N30011C4G |
| 3210 | 2210503906 | E452I2N30011C4K |
| 3211 | 2210503907 | E452I2N30011C4L |
| 3212 | N/A | N/A |
| 3213 | N/A | N/A |
| 3214 | N/A | N/A |
| 3215 | N/A | N/A |
| 3216 | 2210503908 | E452I2N30011R05 |
| 3217 | N/A | N/A |
| 3218 | N/A | N/A |
| 3219 | N/A | N/A |
| 3220 | N/A | N/A |
| 3221 | N/A | N/A |
| 3222 | N/A | N/A |
| 3223 | N/A | N/A |
| 3224 | N/A | N/A |
| 3225 | N/A | N/A |
| 3226 | N/A | N/A |
| 3227 | 2210503909 | E452I2N30011R21 |
| 3228 | 2210503910 | E452I2N30011R22 |
| 3229 | 2210503911 | E452I2N30011R23 |
| 3230 | 2210503912 | E452I2N30011R24 |
| 3231 | 2210503913 | E452I2N30011R25 |
| 3232 | 2210503914 | E452I2N30011R2A |
| 3233 | 2210503915 | E452I2N30011R2B |
| 3234 | 2210503916 | E452I2N30011R2C |
| 3235 | 2210503917 | E452I2N30011R2D |
| 3236 | 2210503918 | E452I2N30011R2E |
| 3237 | 2210503919 | E452I2N30011R2G |
| 3238 | 2210503920 | E452I2N30011R2H |
| 3239 | 2210503921 | E452I2N30011R2K |
| 3240 | 2210503922 | E452I2N30011R2L |

| | | | | | | | | |
|---|--|---|--|---|--|---|--|---|
| THIS DRAWING CONTAINS INFORMATION THAT IS PROPRIETARY TO MOLEX ELECTRONIC TECHNOLOGIES, LLC AND SHOULD NOT BE USED WITHOUT WRITTEN PERMISSION | | SCALE NTS | | CURRENT REV DESC: REVISION CREATED FOR REMOVING PRE-RELEASE STAMP | |  E452XXXXXXXXXX DIN FORM A EN 175301-803 | | |
| DIMENSION UNITS mm | | GENERAL TOLERANCES (UNLESS SPECIFIED) | | EC NO: 714567 DRWN: SUGEEB CHK'D: GGA APPR: GGA | | | | PRODUCT CUSTOMER DRAWING DOCUMENT NUMBER SD-121050-001 DOC TYPE: PSD DOC PART: 001 REVISION: E1 |
| | | MM INCH | | 2022/07/18 2022/07/19 2022/07/19 | | | | |
| 4 PLACES ± | | ± | | INITIAL REVISION: DRWN: JMARSZALEK APPR: MDYSZEWSKA | | | | |
| 3 PLACES ± | | ± | | 2012/08/27 2012/08/20 | | | | |
| 2 PLACES ± | | ± | | | | MATERIAL NUMBER CUSTOMER SHEET NUMBER | | |
| 1 PLACE ± | | ± | | | | | | |
| 0 PLACES ± | | ± | | | | SEE TABLE GENERAL MARKET 23 OF 41 | | |
| ANGULAR TOL ± ° | | ± ° | | | | | | |
| DRAFT WHERE APPLICABLE MUST REMAIN WITHIN DIMENSIONS | | FIRST ANGLE PROJECTION | | DRAWING | | | | |
| | |  | | A3-SIZE | | SERIES 121050 | | |

TABLE 3 - PART LIST

| Pos. | Molex PN: | Engineering No.: |
|------|------------|------------------|
| 3241 | 2210503973 | E452I2N30011R2M |
| 3242 | 2210503974 | E452I2N30011S01 |
| 3243 | 2210503975 | E452I2N30011S02 |
| 3244 | 2210503976 | E452I2N30011S03 |
| 3245 | 2210503977 | E452I2N30011S04 |
| 3246 | 2210503978 | E452I2N30011S05 |
| 3247 | 2210503979 | E452I2N30011S0A |
| 3248 | 2210503980 | E452I2N30011S0B |
| 3249 | 2210503981 | E452I2N30011S0C |
| 3250 | 2210503982 | E452I2N30011S0D |
| 3251 | 2210503983 | E452I2N30011S0E |
| 3252 | 2210503984 | E452I2N30011S0G |
| 3253 | 2210503985 | E452I2N30011S0H |
| 3254 | 2210503986 | E452I2N30011S0K |
| 3255 | 2210503987 | E452I2N30011S0L |
| 3256 | 2210503988 | E452I2N30011S0M |
| 3257 | 2210503989 | E452I2N50011000 |
| 3258 | 2210503990 | E452I2N50011A11 |
| 3259 | 2210503991 | E452I2N50011A12 |
| 3260 | 2210503992 | E452I2N50011A13 |
| 3261 | 2210503993 | E452I2N50011A14 |
| 3262 | 2210503994 | E452I2N50011A15 |
| 3263 | 2210503995 | E452I2N50011A1A |
| 3264 | 2210503996 | E452I2N50011A1B |
| 3265 | 2210503997 | E452I2N50011A1C |
| 3266 | 2210503998 | E452I2N50011A1D |
| 3267 | 2210503999 | E452I2N50011A1E |
| 3268 | 2210504000 | E452I2N50011A1G |
| 3269 | 2210504001 | E452I2N50011A1H |
| 3270 | 2210504002 | E452I2N50011A1K |
| 3271 | 2210504003 | E452I2N50011A1L |
| 3272 | 2210504004 | E452I2N50011A1M |
| 3273 | 2210504005 | E452I2N50011C31 |
| 3274 | 2210504006 | E452I2N50011C32 |
| 3275 | 2210504007 | E452I2N50011C33 |
| 3276 | 2210504008 | E452I2N50011C34 |
| 3277 | 2210504009 | E452I2N50011C35 |
| 3278 | 2210504010 | E452I2N50011C3A |
| 3279 | 2210504011 | E452I2N50011C3B |
| 3280 | 2210504012 | E452I2N50011C3C |

| Pos. | Molex PN: | Engineering No.: |
|------|------------|------------------|
| 3281 | 2210504013 | E452I2N50011C3D |
| 3282 | 2210504014 | E452I2N50011C3E |
| 3283 | 2210504015 | E452I2N50011C3G |
| 3284 | 2210504016 | E452I2N50011C3K |
| 3285 | 2210504017 | E452I2N50011C3L |
| 3286 | 2210504018 | E452I2N50011C3M |
| 3287 | 2210504019 | E452I2N50011C41 |
| 3288 | 2210504020 | E452I2N50011C43 |
| 3289 | 2210504021 | E452I2N50011C45 |
| 3290 | 2210504022 | E452I2N50011C4A |
| 3291 | 2210504023 | E452I2N50011C4B |
| 3292 | 2210504024 | E452I2N50011C4C |
| 3293 | 2210504025 | E452I2N50011C4D |
| 3294 | 2210504026 | E452I2N50011C4E |
| 3295 | 2210504027 | E452I2N50011C4G |
| 3296 | 2210504028 | E452I2N50011C4K |
| 3297 | 2210504029 | E452I2N50011C4L |
| 3298 | 2210504030 | E452I2N50011C4M |
| 3299 | 2210504035 | E452I2N50011E05 |
| 3300 | N/A | N/A |
| 3301 | N/A | N/A |
| 3302 | N/A | N/A |
| 3303 | N/A | N/A |
| 3304 | 2210504050 | E452I2N50011R05 |
| 3305 | N/A | N/A |
| 3306 | N/A | N/A |
| 3307 | N/A | N/A |
| 3308 | N/A | N/A |
| 3309 | N/A | N/A |
| 3310 | N/A | N/A |
| 3311 | N/A | N/A |
| 3312 | N/A | N/A |
| 3313 | N/A | N/A |
| 3314 | N/A | N/A |
| 3315 | 2210504061 | E452I2N50011R21 |
| 3316 | 2210504062 | E452I2N50011R22 |
| 3317 | 2210504063 | E452I2N50011R23 |
| 3318 | 2210504064 | E452I2N50011R24 |
| 3319 | 2210504065 | E452I2N50011R25 |
| 3320 | 2210504066 | E452I2N50011R2A |

| Pos. | Molex PN: | Engineering No.: |
|------|------------|------------------|
| 3321 | 2210504067 | E452I2N50011R2B |
| 3322 | 2210504068 | E452I2N50011R2C |
| 3323 | 2210504069 | E452I2N50011R2D |
| 3324 | 2210504070 | E452I2N50011R2E |
| 3325 | 2210504071 | E452I2N50011R2G |
| 3326 | 2210504072 | E452I2N50011R2H |
| 3327 | 2210504073 | E452I2N50011R2K |
| 3328 | 2210504074 | E452I2N50011R2L |
| 3329 | 2210504075 | E452I2N50011R2M |
| 3330 | 2210504076 | E452I2N50011S01 |
| 3331 | 2210504077 | E452I2N50011S02 |
| 3332 | 2210504078 | E452I2N50011S03 |
| 3333 | 2210504079 | E452I2N50011S04 |
| 3334 | 2210504080 | E452I2N50011S05 |
| 3335 | 2210504081 | E452I2N50011S0A |
| 3336 | 2210504082 | E452I2N50011S0B |
| 3337 | 2210504083 | E452I2N50011S0C |
| 3338 | 2210504084 | E452I2N50011S0D |
| 3339 | 2210504085 | E452I2N50011S0E |
| 3340 | 2210504086 | E452I2N50011S0G |
| 3341 | 2210504087 | E452I2N50011S0H |
| 3342 | 2210504088 | E452I2N50011S0K |
| 3343 | 2210504089 | E452I2N50011S0L |
| 3344 | 2210504090 | E452I2N50011S0M |
| 3345 | 2210504091 | E452I4N10011000 |
| 3346 | 2210504092 | E452I4N10011A11 |
| 3347 | 2210504093 | E452I4N10011A12 |
| 3348 | 2210504094 | E452I4N10011A13 |
| 3349 | 2210504095 | E452I4N10011A14 |
| 3350 | 2210504096 | E452I4N10011A15 |
| 3351 | 2210504097 | E452I4N10011A1A |
| 3352 | 2210504098 | E452I4N10011A1B |
| 3353 | 2210504099 | E452I4N10011A1C |
| 3354 | 2210504100 | E452I4N10011A1D |
| 3355 | 2210504101 | E452I4N10011A1E |
| 3356 | 2210504102 | E452I4N10011A1G |
| 3357 | 2210504103 | E452I4N10011A1H |
| 3358 | 2210504104 | E452I4N10011A1K |
| 3359 | 2210504105 | E452I4N10011A1L |
| 3360 | 2210504106 | E452I4N10011A1M |

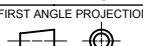
| Pos. | Molex PN: | Engineering No.: |
|------|------------|------------------|
| 3361 | 2210504107 | E452I4N10011C31 |
| 3362 | 2210504108 | E452I4N10011C32 |
| 3363 | 2210504109 | E452I4N10011C33 |
| 3364 | 2210504110 | E452I4N10011C34 |
| 3365 | 2210504111 | E452I4N10011C35 |
| 3366 | 2210504112 | E452I4N10011C3A |
| 3367 | 2210504113 | E452I4N10011C3B |
| 3368 | 2210504114 | E452I4N10011C3C |
| 3369 | 2210504115 | E452I4N10011C3D |
| 3370 | 2210504116 | E452I4N10011C3E |
| 3371 | 2210504117 | E452I4N10011C3G |
| 3372 | 2210504118 | E452I4N10011C3H |
| 3373 | 2210504119 | E452I4N10011C3K |
| 3374 | 2210504120 | E452I4N10011C3L |
| 3375 | 2210504121 | E452I4N10011C3M |
| 3376 | 2210504122 | E452I4N10011C41 |
| 3377 | 2210504123 | E452I4N10011C43 |
| 3378 | 2210504124 | E452I4N10011C44 |
| 3379 | 2210504125 | E452I4N10011C45 |
| 3380 | 2210504126 | E452I4N10011C4A |
| 3381 | 2210504127 | E452I4N10011C4B |
| 3382 | 2210504128 | E452I4N10011C4C |
| 3383 | 2210504129 | E452I4N10011C4D |
| 3384 | 2210504130 | E452I4N10011C4E |
| 3385 | 2210504131 | E452I4N10011C4G |
| 3386 | 2210504132 | E452I4N10011C4K |
| 3387 | 2210504133 | E452I4N10011C4L |
| 3388 | 2210504134 | E452I4N10011C4M |
| 3389 | 2210504139 | E452I4N10011E05 |
| 3390 | N/A | N/A |
| 3391 | N/A | N/A |
| 3392 | N/A | N/A |
| 3393 | N/A | N/A |
| 3394 | 2210504154 | E452I4N10011R05 |
| 3395 | N/A | N/A |
| 3396 | N/A | N/A |
| 3397 | N/A | N/A |
| 3398 | N/A | N/A |
| 3399 | N/A | N/A |
| 3400 | N/A | N/A |

| | | | | | | | | | |
|---|--|-------|--|---|--|----------------|--|---|--|
| THIS DRAWING CONTAINS INFORMATION THAT IS PROPRIETARY TO MOLEX ELECTRONIC TECHNOLOGIES, LLC AND SHOULD NOT BE USED WITHOUT WRITTEN PERMISSION | | | | | | | | | |
| DIMENSION UNITS | | SCALE | | CURRENT REV DESC: REVISION CREATED FOR REMOVING PRE-RELEASE STAMP | | | |  E452XXXXXXXXXX DIN FORM A EN 175301-803 | |
| mm | | NTS | | | | | | | |
| GENERAL TOLERANCES (UNLESS SPECIFIED) | | | | EC NO: 714567 | | 2022/07/18 | | PRODUCT CUSTOMER DRAWING DOCUMENT NUMBER: SD-121050-001 DOC TYPE: PSD DOC PART: 001 REVISION: E1 | |
| | | | | DRWN: SUGEEB | | 2022/07/19 | | | |
| | | | | CHK'D: GGA | | 2022/07/19 | | | |
| | | | | APPR: GGA | | | | | |
| | | | | INITIAL REVISION: | | | | | |
| | | | | DRWN: JMARSZALEK | | 2012/08/27 | | | |
| | | | | APPR: MDYSZEWSKA | | 2012/08/20 | | | |
| | | | | FIRST ANGLE PROJECTION | | DRAWING | | SERIES | |
| DRAFT WHERE APPLICABLE MUST REMAIN WITHIN DIMENSIONS | | | |  | | A3-SIZE | | 121050 | |
| | | | | MATERIAL NUMBER | | CUSTOMER | | SHEET NUMBER | |
| | | | | SEE TABLE | | GENERAL MARKET | | 24 OF 41 | |

TABLE 3 - PART LIST

| Pos. | Molex PN: | Engineering No.: |
|------|------------|------------------|
| 3401 | N/A | N/A |
| 3402 | N/A | N/A |
| 3403 | N/A | N/A |
| 3404 | N/A | N/A |
| 3405 | 2210504165 | E452I4N10011R21 |
| 3406 | 2210504166 | E452I4N10011R22 |
| 3407 | 2210504167 | E452I4N10011R23 |
| 3408 | 2210504168 | E452I4N10011R24 |
| 3409 | 2210504169 | E452I4N10011R25 |
| 3410 | 2210504170 | E452I4N10011R2A |
| 3411 | 2210504171 | E452I4N10011R2B |
| 3412 | 2210504172 | E452I4N10011R2C |
| 3413 | 2210504173 | E452I4N10011R2D |
| 3414 | 2210504174 | E452I4N10011R2E |
| 3415 | 2210504175 | E452I4N10011R2G |
| 3416 | 2210504176 | E452I4N10011R2H |
| 3417 | 2210504177 | E452I4N10011R2K |
| 3418 | 2210504178 | E452I4N10011R2L |
| 3419 | 2210504179 | E452I4N10011R2M |
| 3420 | 2210504180 | E452I4N10011S01 |
| 3421 | 2210504181 | E452I4N10011S02 |
| 3422 | 2210504182 | E452I4N10011S03 |
| 3423 | 2210504183 | E452I4N10011S04 |
| 3424 | 2210504184 | E452I4N10011S05 |
| 3425 | 2210504185 | E452I4N10011S0A |
| 3426 | 2210504186 | E452I4N10011S0B |
| 3427 | 2210504187 | E452I4N10011S0C |
| 3428 | 2210504188 | E452I4N10011S0D |
| 3429 | 2210504189 | E452I4N10011S0E |
| 3430 | 2210504190 | E452I4N10011S0G |
| 3431 | 2210504191 | E452I4N10011S0H |
| 3432 | 2210504192 | E452I4N10011S0K |
| 3433 | 2210504193 | E452I4N10011S0L |
| 3434 | 2210504194 | E452I4N10011S0M |
| 3435 | 2210504195 | E452I4N10K11000 |
| 3436 | 2210504196 | E452I4N10K11A11 |
| 3437 | 2210504197 | E452I4N10K11A12 |
| 3438 | 2210504198 | E452I4N10K11A13 |
| 3439 | 2210504199 | E452I4N10K11A14 |
| 3440 | 2210504200 | E452I4N10K11A15 |

| Pos. | Molex PN: | Engineering No.: |
|------|------------|------------------|
| 3441 | 2210504201 | E452I4N10K11A1A |
| 3442 | 2210504202 | E452I4N10K11A1B |
| 3443 | 2210504203 | E452I4N10K11A1C |
| 3444 | 2210504204 | E452I4N10K11A1D |
| 3445 | 2210504205 | E452I4N10K11A1E |
| 3446 | 2210504206 | E452I4N10K11A1G |
| 3447 | 2210504207 | E452I4N10K11A1H |
| 3448 | 2210504208 | E452I4N10K11A1K |
| 3449 | 2210504209 | E452I4N10K11A1L |
| 3450 | 2210504210 | E452I4N10K11A1M |
| 3451 | 2210504211 | E452I4N10K11C31 |
| 3452 | 2210504212 | E452I4N10K11C32 |
| 3453 | 2210504213 | E452I4N10K11C33 |
| 3454 | 2210504214 | E452I4N10K11C34 |
| 3455 | 2210504215 | E452I4N10K11C35 |
| 3456 | 2210504216 | E452I4N10K11C3A |
| 3457 | 2210504217 | E452I4N10K11C3B |
| 3458 | 2210504218 | E452I4N10K11C3C |
| 3459 | 2210504219 | E452I4N10K11C3D |
| 3460 | 2210504220 | E452I4N10K11C3E |
| 3461 | 2210504221 | E452I4N10K11C3G |
| 3462 | 2210504222 | E452I4N10K11C3K |
| 3463 | 2210504223 | E452I4N10K11C3L |
| 3464 | 2210504224 | E452I4N10K11C3M |
| 3465 | 2210504225 | E452I4N10K11C41 |
| 3466 | 2210504226 | E452I4N10K11C42 |
| 3467 | 2210504227 | E452I4N10K11C43 |
| 3468 | 2210504228 | E452I4N10K11C44 |
| 3469 | 2210504229 | E452I4N10K11C45 |
| 3470 | 2210504230 | E452I4N10K11C4A |
| 3471 | 2210504231 | E452I4N10K11C4B |
| 3472 | 2210504232 | E452I4N10K11C4C |
| 3473 | 2210504233 | E452I4N10K11C4D |
| 3474 | 2210504234 | E452I4N10K11C4E |
| 3475 | 2210504235 | E452I4N10K11C4G |
| 3476 | 2210504236 | E452I4N10K11C4K |
| 3477 | 2210504237 | E452I4N10K11C4M |
| 3478 | 2210504242 | E452I4N10K11E05 |
| 3479 | N/A | N/A |
| 3480 | N/A | N/A |

| Pos. | Molex PN: | Engineering No.: |
|------|------------|------------------|
| 3481 | N/A | N/A |
| 3482 | N/A | N/A |
| 3483 | 2210504257 | E452I4N10K11R05 |
| 3484 | N/A | N/A |
| 3485 | N/A | N/A |
| 3486 | N/A | N/A |
| 3487 | N/A | N/A |
| 3488 | N/A | N/A |
| 3489 | N/A | N/A |
| 3490 | N/A | N/A |
| 3491 | N/A | N/A |
| 3492 | N/A | N/A |
| 3493 | N/A | N/A |
| 3494 | 2210504268 | E452I4N10K11R21 |
| 3495 | 2210504269 | E452I4N10K11R22 |
| 3496 | 2210504270 | E452I4N10K11R23 |
| 3497 | 2210504271 | E452I4N10K11R24 |
| 3498 | 2210504272 | E452I4N10K11R25 |
| 3499 | 2210504273 | E452I4N10K11R2A |
| 3500 | 2210504274 | E452I4N10K11R2B |
| 3501 | 2210504275 | E452I4N10K11R2C |
| 3502 | 2210504276 | E452I4N10K11R2D |
| 3503 | 2210504277 | E452I4N10K11R2E |
| 3504 | 2210504278 | E452I4N10K11R2G |
| 3505 | 2210504279 | E452I4N10K11R2H |
| 3506 | 2210504280 | E452I4N10K11R2K |
| 3507 | 2210504281 | E452I4N10K11R2L |
| 3508 | 2210504282 | E452I4N10K11R2M |
| 3509 | 2210504283 | E452I4N10K11S01 |
| 3510 | 2210504284 | E452I4N10K11S02 |
| 3511 | 2210504285 | E452I4N10K11S03 |
| 3512 | 2210504286 | E452I4N10K11S04 |
| 3513 | 2210504287 | E452I4N10K11S05 |
| 3514 | 2210504288 | E452I4N10K11S0A |
| 3515 | 2210504289 | E452I4N10K11S0B |
| 3516 | 2210504290 | E452I4N10K11S0C |
| 3517 | 2210504291 | E452I4N10K11S0D |
| 3518 | 2210504292 | E452I4N10K11S0E |
| 3519 | 2210504293 | E452I4N10K11S0G |
| 3520 | 2210504294 | E452I4N10K11S0H |

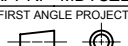
| Pos. | Molex PN: | Engineering No.: |
|------|------------|------------------|
| 3521 | 2210504295 | E452I4N10K11S0K |
| 3522 | 2210504296 | E452I4N10K11S0L |
| 3523 | 2210504297 | E452I4N10K11S0M |
| 3524 | 2210504298 | E452I4N15011000 |
| 3525 | 2210504299 | E452I4N15011A11 |
| 3526 | 2210504300 | E452I4N15011A12 |
| 3527 | 2210504301 | E452I4N15011A13 |
| 3528 | 2210504302 | E452I4N15011A14 |
| 3529 | 2210504303 | E452I4N15011A15 |
| 3530 | 2210504304 | E452I4N15011A1A |
| 3531 | 2210504305 | E452I4N15011A1B |
| 3532 | 2210504306 | E452I4N15011A1C |
| 3533 | 2210504307 | E452I4N15011A1D |
| 3534 | 2210504308 | E452I4N15011A1E |
| 3535 | 2210504309 | E452I4N15011A1G |
| 3536 | 2210504310 | E452I4N15011A1K |
| 3537 | 2210504311 | E452I4N15011A1L |
| 3538 | 2210504312 | E452I4N15011A1M |
| 3539 | 2210504313 | E452I4N15011C31 |
| 3540 | 2210504314 | E452I4N15011C32 |
| 3541 | 2210504315 | E452I4N15011C33 |
| 3542 | 2210504316 | E452I4N15011C34 |
| 3543 | 2210504317 | E452I4N15011C35 |
| 3544 | 2210504318 | E452I4N15011C3A |
| 3545 | 2210504319 | E452I4N15011C3B |
| 3546 | 2210504320 | E452I4N15011C3C |
| 3547 | 2210504321 | E452I4N15011C3D |
| 3548 | 2210504322 | E452I4N15011C3E |
| 3549 | 2210504323 | E452I4N15011C3G |
| 3550 | 2210504324 | E452I4N15011C3H |
| 3551 | 2210504325 | E452I4N15011C3K |
| 3552 | 2210504326 | E452I4N15011C3L |
| 3553 | 2210504327 | E452I4N15011C3M |
| 3554 | 2210504328 | E452I4N15011C41 |
| 3555 | 2210504329 | E452I4N15011C42 |
| 3556 | 2210504330 | E452I4N15011C43 |
| 3557 | 2210504331 | E452I4N15011C44 |
| 3558 | 2210504332 | E452I4N15011C45 |
| 3559 | 2210504333 | E452I4N15011C4A |
| 3560 | 2210504334 | E452I4N15011C4B |

| | | | |
|---|---------------------|---|---|
| THIS DRAWING CONTAINS INFORMATION THAT IS PROPRIETARY TO MOLEX ELECTRONIC TECHNOLOGIES, LLC AND SHOULD NOT BE USED WITHOUT WRITTEN PERMISSION | | | |
| DIMENSION UNITS mm | SCALE NTS | CURRENT REV DESC: REVISION CREATED FOR REMOVING PRE-RELEASE STAMP | |
| GENERAL TOLERANCES (UNLESS SPECIFIED) | |  E452XXXXXXXXXX DIN FORM A EN 175301-803 | |
| | MM INCH | | |
| 4 PLACES ± | ± | | |
| 3 PLACES ± | ± | | |
| 2 PLACES ± | ± | | |
| 1 PLACE ± | ± | EC NO: 714567 DRWN: SUGEEB 2022/07/18 CHK'D: GGA 2022/07/19 APPR: GGA 2022/07/19 | PRODUCT CUSTOMER DRAWING |
| 0 PLACES ± | ± | INITIAL REVISION: DRWN: JMARSZALEK 2012/08/27 APPR: MDYSZEWSKA 2012/08/20 | DOCUMENT NUMBER SD-121050-001 |
| DRAFT WHERE APPLICABLE MUST REMAIN WITHIN DIMENSIONS | | FIRST ANGLE PROJECTION  | DRAWING A3-SIZE |
| | | SERIES 121050 | MATERIAL NUMBER SEE TABLE |
| | | CUSTOMER GENERAL MARKET | REVISION E1 |
| | | SHEET NUMBER 25 OF 41 | |

TABLE 3 - PART LIST

| Pos. | Molex PN: | Engineering No.: |
|------|------------|------------------|
| 3561 | 2210504335 | E452I4N15011C4C |
| 3562 | 2210504336 | E452I4N15011C4D |
| 3563 | 2210504337 | E452I4N15011C4E |
| 3564 | 2210504338 | E452I4N15011C4G |
| 3565 | 2210504339 | E452I4N15011C4K |
| 3566 | 2210504340 | E452I4N15011C4L |
| 3567 | 2210504341 | E452I4N15011C4M |
| 3568 | 2210504346 | E452I4N15011E05 |
| 3569 | N/A | N/A |
| 3570 | N/A | N/A |
| 3571 | N/A | N/A |
| 3572 | N/A | N/A |
| 3573 | 2210504361 | E452I4N15011R05 |
| 3574 | N/A | N/A |
| 3575 | N/A | N/A |
| 3576 | N/A | N/A |
| 3577 | N/A | N/A |
| 3578 | N/A | N/A |
| 3579 | N/A | N/A |
| 3580 | N/A | N/A |
| 3581 | N/A | N/A |
| 3582 | N/A | N/A |
| 3583 | N/A | N/A |
| 3584 | 2210504372 | E452I4N15011R21 |
| 3585 | 2210504373 | E452I4N15011R23 |
| 3586 | 2210504374 | E452I4N15011R24 |
| 3587 | 2210504375 | E452I4N15011R25 |
| 3588 | 2210504376 | E452I4N15011R2A |
| 3589 | 2210504377 | E452I4N15011R2B |
| 3590 | 2210504378 | E452I4N15011R2C |
| 3591 | 2210504379 | E452I4N15011R2D |
| 3592 | 2210504380 | E452I4N15011R2E |
| 3593 | 2210504381 | E452I4N15011R2G |
| 3594 | 2210504382 | E452I4N15011R2H |
| 3595 | 2210504383 | E452I4N15011R2K |
| 3596 | 2210504384 | E452I4N15011R2L |
| 3597 | 2210504385 | E452I4N15011R2M |
| 3598 | 2210504386 | E452I4N15011S01 |
| 3599 | 2210504387 | E452I4N15011S02 |
| 3600 | 2210504388 | E452I4N15011S03 |

| Pos. | Molex PN: | Engineering No.: |
|------|------------|------------------|
| 3601 | 2210504389 | E452I4N15011S04 |
| 3602 | 2210504390 | E452I4N15011S05 |
| 3603 | 2210504391 | E452I4N15011S0A |
| 3604 | 2210504392 | E452I4N15011S0B |
| 3605 | 2210504393 | E452I4N15011S0C |
| 3606 | 2210504394 | E452I4N15011S0D |
| 3607 | 2210504395 | E452I4N15011S0E |
| 3608 | 2210504396 | E452I4N15011S0G |
| 3609 | 2210504397 | E452I4N15011S0H |
| 3610 | 2210504398 | E452I4N15011S0K |
| 3611 | 2210504399 | E452I4N15011S0L |
| 3612 | 2210504400 | E452I4N15011S0M |
| 3613 | 2210504401 | E452I4N20011000 |
| 3614 | 2210504402 | E452I4N20011A11 |
| 3615 | 2210504403 | E452I4N20011A12 |
| 3616 | 2210504404 | E452I4N20011A13 |
| 3617 | 2210504405 | E452I4N20011A14 |
| 3618 | 2210504406 | E452I4N20011A15 |
| 3619 | 2210504407 | E452I4N20011A1A |
| 3620 | 2210504408 | E452I4N20011A1B |
| 3621 | 2210504409 | E452I4N20011A1C |
| 3622 | 2210504410 | E452I4N20011A1D |
| 3623 | 2210504411 | E452I4N20011A1E |
| 3624 | 2210504412 | E452I4N20011A1G |
| 3625 | 2210504413 | E452I4N20011A1H |
| 3626 | 2210504414 | E452I4N20011A1K |
| 3627 | 2210504415 | E452I4N20011A1L |
| 3628 | 2210504416 | E452I4N20011A1M |
| 3629 | 2210504417 | E452I4N20011C31 |
| 3630 | 2210504418 | E452I4N20011C32 |
| 3631 | 2210504419 | E452I4N20011C33 |
| 3632 | 2210504420 | E452I4N20011C34 |
| 3633 | 2210504421 | E452I4N20011C35 |
| 3634 | 2210504422 | E452I4N20011C3A |
| 3635 | 2210504423 | E452I4N20011C3C |
| 3636 | 2210504424 | E452I4N20011C3D |
| 3637 | 2210504425 | E452I4N20011C3E |
| 3638 | 2210504426 | E452I4N20011C3G |
| 3639 | 2210504427 | E452I4N20011C3K |
| 3640 | 2210504428 | E452I4N20011C3L |

| Pos. | Molex PN: | Engineering No.: |
|------|------------|------------------|
| 3641 | 2210504429 | E452I4N20011C3M |
| 3642 | 2210504430 | E452I4N20011C41 |
| 3643 | 2210504431 | E452I4N20011C42 |
| 3644 | 2210504432 | E452I4N20011C43 |
| 3645 | 2210504433 | E452I4N20011C44 |
| 3646 | 2210504434 | E452I4N20011C45 |
| 3647 | 2210504435 | E452I4N20011C4A |
| 3648 | 2210504436 | E452I4N20011C4B |
| 3649 | 2210504437 | E452I4N20011C4C |
| 3650 | 2210504438 | E452I4N20011C4D |
| 3651 | 2210504439 | E452I4N20011C4E |
| 3652 | 2210504440 | E452I4N20011C4G |
| 3653 | 2210504441 | E452I4N20011C4K |
| 3654 | 2210504442 | E452I4N20011C4L |
| 3655 | 2210504443 | E452I4N20011C4M |
| 3656 | 2210504448 | E452I4N20011E05 |
| 3657 | N/A | N/A |
| 3658 | N/A | N/A |
| 3659 | N/A | N/A |
| 3660 | N/A | N/A |
| 3661 | 2210504463 | E452I4N20011R05 |
| 3662 | N/A | N/A |
| 3663 | N/A | N/A |
| 3664 | N/A | N/A |
| 3665 | N/A | N/A |
| 3666 | N/A | N/A |
| 3667 | N/A | N/A |
| 3668 | N/A | N/A |
| 3669 | N/A | N/A |
| 3670 | N/A | N/A |
| 3671 | N/A | N/A |
| 3672 | 2210504474 | E452I4N20011R21 |
| 3673 | 2210504475 | E452I4N20011R22 |
| 3674 | 2210504476 | E452I4N20011R23 |
| 3675 | 2210504477 | E452I4N20011R24 |
| 3676 | 2210504478 | E452I4N20011R25 |
| 3677 | 2210504479 | E452I4N20011R2A |
| 3678 | 2210504480 | E452I4N20011R2B |
| 3679 | 2210504481 | E452I4N20011R2C |
| 3680 | 2210504482 | E452I4N20011R2D |

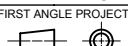
| Pos. | Molex PN: | Engineering No.: |
|------|------------|------------------|
| 3681 | 2210504483 | E452I4N20011R2E |
| 3682 | 2210504484 | E452I4N20011R2G |
| 3683 | 2210504485 | E452I4N20011R2H |
| 3684 | 2210504486 | E452I4N20011R2K |
| 3685 | 2210504487 | E452I4N20011R2L |
| 3686 | 2210504488 | E452I4N20011R2M |
| 3687 | 2210504489 | E452I4N20011S01 |
| 3688 | 2210504490 | E452I4N20011S02 |
| 3689 | 2210504491 | E452I4N20011S03 |
| 3690 | 2210504492 | E452I4N20011S04 |
| 3691 | 2210504493 | E452I4N20011S05 |
| 3692 | 2210504494 | E452I4N20011S0A |
| 3693 | 2210504495 | E452I4N20011S0B |
| 3694 | 2210504496 | E452I4N20011S0C |
| 3695 | 2210504497 | E452I4N20011S0D |
| 3696 | 2210504498 | E452I4N20011S0E |
| 3697 | 2210504499 | E452I4N20011S0G |
| 3698 | 2210504500 | E452I4N20011S0H |
| 3699 | 2210504501 | E452I4N20011S0K |
| 3700 | 2210504502 | E452I4N20011S0L |
| 3701 | 2210504503 | E452I4N20011S0M |
| 3702 | 2210504504 | E452I4N30011000 |
| 3703 | 2210504505 | E452I4N30011A11 |
| 3704 | 2210504506 | E452I4N30011A12 |
| 3705 | 2210504507 | E452I4N30011A13 |
| 3706 | 2210504508 | E452I4N30011A14 |
| 3707 | 2210504509 | E452I4N30011A15 |
| 3708 | 2210504510 | E452I4N30011A1A |
| 3709 | 2210504511 | E452I4N30011A1B |
| 3710 | 2210504512 | E452I4N30011A1C |
| 3711 | 2210504513 | E452I4N30011A1D |
| 3712 | 2210504514 | E452I4N30011A1E |
| 3713 | 2210504515 | E452I4N30011A1K |
| 3714 | 2210504516 | E452I4N30011A1L |
| 3715 | 2210504517 | E452I4N30011A1M |
| 3716 | 2210504518 | E452I4N30011C32 |
| 3717 | 2210504519 | E452I4N30011C33 |
| 3718 | 2210504520 | E452I4N30011C34 |
| 3719 | 2210504521 | E452I4N30011C35 |
| 3720 | 2210504522 | E452I4N30011C3A |

| | | | | | | | |
|---|--|-------|--|---|--|--|--|
| THIS DRAWING CONTAINS INFORMATION THAT IS PROPRIETARY TO MOLEX ELECTRONIC TECHNOLOGIES, LLC AND SHOULD NOT BE USED WITHOUT WRITTEN PERMISSION | | SCALE | | CURRENT REV DESC: REVISION CREATED FOR REMOVING PRE-RELEASE STAMP | | molex | |
| DIMENSION UNITS | | mm | | NTS | | | |
| GENERAL TOLERANCES (UNLESS SPECIFIED) | | | | | | E452XXXXXXXXXX DIN FORM A EN 175301-803 | |
| | | | | | | PRODUCT CUSTOMER DRAWING | |
| | | | | | | DOCUMENT NUMBER | |
| | | | | | | SD-121050-001 | |
| | | | | | | DOC TYPE | |
| | | | | | | PSD | |
| | | | | | | DOC PART | |
| | | | | | | 001 | |
| | | | | | | REVISION | |
| | | | | | | E1 | |
| DRAFT WHERE APPLICABLE MUST REMAIN WITHIN DIMENSIONS | | | | FIRST ANGLE PROJECTION | | DRAWING | |
| | | | | | | A3-SIZE | |
| | | | | | | SERIES | |
| | | | | | | 121050 | |
| | | | | | | MATERIAL NUMBER | |
| | | | | | | SEE TABLE | |
| | | | | | | CUSTOMER | |
| | | | | | | GENERAL MARKET | |
| | | | | | | SHEET NUMBER | |
| | | | | | | 26 OF 41 | |

TABLE 3 - PART LIST

| Pos. | Molex PN: | Engineering No.: |
|------|------------|------------------|
| 4041 | 2210504983 | E452N2N15011R2H |
| 4042 | 2210504984 | E452N2N15011R2K |
| 4043 | 2210504985 | E452N2N15011R2L |
| 4044 | 2210504986 | E452N2N15011R2M |
| 4045 | 2210504987 | E452N2N15011S01 |
| 4046 | 2210504988 | E452N2N15011S02 |
| 4047 | 2210504989 | E452N2N15011S03 |
| 4048 | 2210504990 | E452N2N15011S04 |
| 4049 | 2210504991 | E452N2N15011S05 |
| 4050 | 2210504992 | E452N2N15011S0A |
| 4051 | 2210504993 | E452N2N15011S0B |
| 4052 | 2210504994 | E452N2N15011S0C |
| 4053 | 2210504995 | E452N2N15011S0D |
| 4054 | 2210504996 | E452N2N15011S0E |
| 4055 | 2210504997 | E452N2N15011S0G |
| 4056 | 2210504998 | E452N2N15011S0H |
| 4057 | 2210504999 | E452N2N15011S0K |
| 4058 | 2210505000 | E452N2N15011S0L |
| 4059 | 2210505001 | E452N2N15011S0M |
| 4060 | 2210505002 | E452N2N20011000 |
| 4061 | 2210505003 | E452N2N20011A12 |
| 4062 | 2210505004 | E452N2N20011A13 |
| 4063 | 2210505005 | E452N2N20011A14 |
| 4064 | 2210505006 | E452N2N20011A15 |
| 4065 | 2210505007 | E452N2N20011A1A |
| 4066 | 2210505008 | E452N2N20011A1B |
| 4067 | 2210505009 | E452N2N20011A1C |
| 4068 | 2210505010 | E452N2N20011A1D |
| 4069 | 2210505011 | E452N2N20011A1E |
| 4070 | 2210505012 | E452N2N20011A1G |
| 4071 | 2210505013 | E452N2N20011A1K |
| 4072 | 2210505014 | E452N2N20011A1L |
| 4073 | 2210505015 | E452N2N20011A1M |
| 4074 | 2210505016 | E452N2N20011C31 |
| 4075 | 2210505017 | E452N2N20011C32 |
| 4076 | 2210505018 | E452N2N20011C33 |
| 4077 | 2210505019 | E452N2N20011C34 |
| 4078 | 2210505020 | E452N2N20011C35 |
| 4079 | 2210505021 | E452N2N20011C3A |
| 4080 | 2210505022 | E452N2N20011C3B |

| Pos. | Molex PN: | Engineering No.: |
|------|------------|------------------|
| 4081 | 2210505023 | E452N2N20011C3C |
| 4082 | 2210505024 | E452N2N20011C3D |
| 4083 | 2210505025 | E452N2N20011C3E |
| 4084 | 2210505026 | E452N2N20011C3G |
| 4085 | 2210505027 | E452N2N20011C3H |
| 4086 | 2210505028 | E452N2N20011C3K |
| 4087 | 2210505029 | E452N2N20011C3L |
| 4088 | 2210505030 | E452N2N20011C3M |
| 4089 | 2210505031 | E452N2N20011C41 |
| 4090 | 2210505032 | E452N2N20011C43 |
| 4091 | 2210505033 | E452N2N20011C44 |
| 4092 | 2210505034 | E452N2N20011C45 |
| 4093 | 2210505035 | E452N2N20011C4A |
| 4094 | 2210505036 | E452N2N20011C4B |
| 4095 | 2210505037 | E452N2N20011C4C |
| 4096 | 2210505038 | E452N2N20011C4D |
| 4097 | 2210505039 | E452N2N20011C4E |
| 4098 | 2210505040 | E452N2N20011C4G |
| 4099 | 2210505041 | E452N2N20011C4K |
| 4100 | 2210505042 | E452N2N20011C4L |
| 4101 | 2210505043 | E452N2N20011C4M |
| 4102 | 2210505062 | E452N2N20011R05 |
| 4103 | 2210505073 | E452N2N20011R21 |
| 4104 | 2210505074 | E452N2N20011R22 |
| 4105 | 2210505075 | E452N2N20011R23 |
| 4106 | 2210505076 | E452N2N20011R24 |
| 4107 | 2210505077 | E452N2N20011R25 |
| 4108 | 2210505078 | E452N2N20011R2A |
| 4109 | 2210505079 | E452N2N20011R2B |
| 4110 | 2210505080 | E452N2N20011R2C |
| 4111 | 2210505081 | E452N2N20011R2D |
| 4112 | 2210505082 | E452N2N20011R2E |
| 4113 | 2210505083 | E452N2N20011R2G |
| 4114 | 2210505084 | E452N2N20011R2H |
| 4115 | 2210505085 | E452N2N20011R2K |
| 4116 | 2210505086 | E452N2N20011R2L |
| 4117 | 2210505087 | E452N2N20011R2M |
| 4118 | 2210505088 | E452N2N20011S01 |
| 4119 | 2210505089 | E452N2N20011S02 |
| 4120 | 2210505090 | E452N2N20011S03 |

| Pos. | Molex PN: | Engineering No.: |
|------|------------|------------------|
| 3641 | 2210504429 | E452I4N20011C3M |
| 3642 | 2210504430 | E452I4N20011C41 |
| 3643 | 2210504431 | E452I4N20011C42 |
| 3644 | 2210504432 | E452I4N20011C43 |
| 3645 | 2210504433 | E452I4N20011C44 |
| 3646 | 2210504434 | E452I4N20011C45 |
| 3647 | 2210504435 | E452I4N20011C4A |
| 3648 | 2210504436 | E452I4N20011C4B |
| 3649 | 2210504437 | E452I4N20011C4C |
| 3650 | 2210504438 | E452I4N20011C4D |
| 3651 | 2210504439 | E452I4N20011C4E |
| 3652 | 2210504440 | E452I4N20011C4G |
| 3653 | 2210504441 | E452I4N20011C4K |
| 3654 | 2210504442 | E452I4N20011C4L |
| 3655 | 2210504443 | E452I4N20011C4M |
| 3656 | 2210504448 | E452I4N20011E05 |
| 3657 | 2210504459 | E452I4N20011R01 |
| 3658 | 2210504460 | E452I4N20011R02 |
| 3659 | 2210504461 | E452I4N20011R03 |
| 3660 | 2210504462 | E452I4N20011R04 |
| 3661 | 2210504463 | E452I4N20011R05 |
| 3662 | 2210504464 | E452I4N20011R0A |
| 3663 | 2210504465 | E452I4N20011R0B |
| 3664 | 2210504466 | E452I4N20011R0C |
| 3665 | 2210504467 | E452I4N20011R0D |
| 3666 | 2210504468 | E452I4N20011R0E |
| 3667 | 2210504469 | E452I4N20011R0G |
| 3668 | 2210504470 | E452I4N20011R0H |
| 3669 | 2210504471 | E452I4N20011R0K |
| 3670 | 2210504472 | E452I4N20011R0L |
| 3671 | 2210504473 | E452I4N20011R0M |
| 3672 | 2210504474 | E452I4N20011R21 |
| 3673 | 2210504475 | E452I4N20011R22 |
| 3674 | 2210504476 | E452I4N20011R23 |
| 3675 | 2210504477 | E452I4N20011R24 |
| 3676 | 2210504478 | E452I4N20011R25 |
| 3677 | 2210504479 | E452I4N20011R2A |
| 3678 | 2210504480 | E452I4N20011R2B |
| 3679 | 2210504481 | E452I4N20011R2C |
| 3680 | 2210504482 | E452I4N20011R2D |

| Pos. | Molex PN: | Engineering No.: |
|------|------------|------------------|
| 4121 | 2210505091 | E452N2N20011S04 |
| 4122 | 2210505092 | E452N2N20011S05 |
| 4123 | 2210505093 | E452N2N20011S0A |
| 4124 | 2210505094 | E452N2N20011S0B |
| 4125 | 2210505095 | E452N2N20011S0C |
| 4126 | 2210505096 | E452N2N20011S0D |
| 4127 | 2210505097 | E452N2N20011S0E |
| 4128 | 2210505098 | E452N2N20011S0G |
| 4129 | 2210505099 | E452N2N20011S0H |
| 4130 | 2210505100 | E452N2N20011S0K |
| 4131 | 2210505101 | E452N2N20011S0L |
| 4132 | 2210505102 | E452N2N20011S0M |
| 4133 | 2210505103 | E452N2N30011000 |
| 4134 | 2210505104 | E452N2N30011A13 |
| 4135 | 2210505105 | E452N2N30011A15 |
| 4136 | 2210505106 | E452N2N30011A1A |
| 4137 | 2210505107 | E452N2N30011A1B |
| 4138 | 2210505108 | E452N2N30011A1C |
| 4139 | 2210505109 | E452N2N30011A1E |
| 4140 | 2210505110 | E452N2N30011A1G |
| 4141 | 2210505111 | E452N2N30011A1K |
| 4142 | 2210505112 | E452N2N30011A1L |
| 4143 | 2210505113 | E452N2N30011C32 |
| 4144 | 2210505114 | E452N2N30011C33 |
| 4145 | 2210505115 | E452N2N30011C34 |
| 4146 | 2210505116 | E452N2N30011C35 |
| 4147 | 2210505117 | E452N2N30011C3A |
| 4148 | 2210505118 | E452N2N30011C3B |
| 4149 | 2210505119 | E452N2N30011C3C |
| 4150 | 2210505120 | E452N2N30011C3D |
| 4151 | 2210505121 | E452N2N30011C3E |
| 4152 | 2210505122 | E452N2N30011C3G |
| 4153 | 2210505123 | E452N2N30011C3K |
| 4154 | 2210505124 | E452N2N30011C3L |
| 4155 | 2210505125 | E452N2N30011C3M |
| 4156 | 2210505126 | E452N2N30011C41 |
| 4157 | 2210505127 | E452N2N30011C43 |
| 4158 | 2210505128 | E452N2N30011C4A |
| 4159 | 2210505129 | E452N2N30011C4B |
| 4160 | 2210505130 | E452N2N30011C4C |



| | | | | | | | | | | | |
|---|--|-------|--|---|--|--------------|--|---------------------|--|---|--|
| THIS DRAWING CONTAINS INFORMATION THAT IS PROPRIETARY TO MOLEX ELECTRONIC TECHNOLOGIES, LLC AND SHOULD NOT BE USED WITHOUT WRITTEN PERMISSION | | | | | | | | | | | |
| DIMENSION UNITS | | SCALE | | CURRENT REV DESC: REVISION CREATED FOR REMOVING PRE-RELEASE STAMP | | | | | |  E452XXXXXXXXXX DIN FORM A EN 175301-803 | |
| mm | | NTS | | | | | | | | | |
| GENERAL TOLERANCES (UNLESS SPECIFIED) | | | | | | | | | | | |
| | | MM | | INCH | | | | | | | |
| 4 PLACES | | ± | | ± | | | | | | | |
| 3 PLACES | | ± | | ± | | | | | | | |
| 2 PLACES | | ± | | ± | | | | | | | |
| 1 PLACE | | ± | | ± | | | | | | | |
| 0 PLACES | | ± | | ± | | | | | | | |
| ANGULAR TOL | | | | ± ° | | | | | | | |
| DRAFT WHERE APPLICABLE MUST REMAIN WITHIN DIMENSIONS | | | | FIRST ANGLE PROJECTION | | DRAWING | | SERIES | | MATERIAL NUMBER | |
| | | | |  | | A3-SIZE | | 121050 | | SEE TABLE | |
| DOCUMENT STATUS | | | | P1 | | RELEASE DATE | | 2022/07/19 09:04:35 | | | |
| | | | | | | | | | | | |

TABLE 3 - PART LIST

| Pos. | Molex PN: | Engineering No.: |
|------|------------|------------------|
| 4161 | 2210505131 | E452N2N30011C4D |
| 4162 | 2210505132 | E452N2N30011C4E |
| 4163 | 2210505133 | E452N2N30011C4G |
| 4164 | 2210505134 | E452N2N30011C4H |
| 4165 | 2210505135 | E452N2N30011C4K |
| 4166 | 2210505136 | E452N2N30011C4L |
| 4167 | 2210505141 | E452N2N30011E05 |
| 4168 | 2210505166 | E452N2N30011R21 |
| 4169 | 2210505167 | E452N2N30011R22 |
| 4170 | 2210505168 | E452N2N30011R23 |
| 4171 | 2210505169 | E452N2N30011R24 |
| 4172 | 2210505170 | E452N2N30011R25 |
| 4173 | 2210505171 | E452N2N30011R2A |
| 4174 | 2210505172 | E452N2N30011R2C |
| 4175 | 2210505173 | E452N2N30011R2D |
| 4176 | 2210505174 | E452N2N30011R2E |
| 4177 | 2210505175 | E452N2N30011R2G |
| 4178 | 2210505176 | E452N2N30011R2H |
| 4179 | 2210505177 | E452N2N30011R2K |
| 4180 | 2210505178 | E452N2N30011R2L |
| 4181 | 2210505179 | E452N2N30011S01 |
| 4182 | 2210505180 | E452N2N30011S02 |
| 4183 | 2210505181 | E452N2N30011S03 |
| 4184 | 2210505182 | E452N2N30011S04 |
| 4185 | 2210505183 | E452N2N30011S05 |
| 4186 | 2210505184 | E452N2N30011S0A |
| 4187 | 2210505185 | E452N2N30011S0B |
| 4188 | 2210505186 | E452N2N30011S0C |
| 4189 | 2210505187 | E452N2N30011S0D |
| 4190 | 2210505188 | E452N2N30011S0E |
| 4191 | 2210505189 | E452N2N30011S0G |
| 4192 | 2210505190 | E452N2N30011S0H |
| 4193 | 2210505191 | E452N2N30011S0K |
| 4194 | 2210505192 | E452N2N30011S0L |
| 4195 | 2210505193 | E452N2N30011S0M |
| 4196 | 2210505194 | E452N2N50011000 |
| 4197 | 2210505195 | E452N2N50011A11 |
| 4198 | 2210505196 | E452N2N50011A12 |
| 4199 | 2210505197 | E452N2N50011A13 |
| 4200 | 2210505198 | E452N2N50011A14 |

| Pos. | Molex PN: | Engineering No.: |
|------|------------|------------------|
| 4201 | 2210505199 | E452N2N50011A15 |
| 4202 | 2210505200 | E452N2N50011A1A |
| 4203 | 2210505201 | E452N2N50011A1B |
| 4204 | 2210505202 | E452N2N50011A1C |
| 4205 | 2210505203 | E452N2N50011A1D |
| 4206 | 2210505204 | E452N2N50011A1E |
| 4207 | 2210505205 | E452N2N50011A1G |
| 4208 | 2210505206 | E452N2N50011A1H |
| 4209 | 2210505207 | E452N2N50011A1K |
| 4210 | 2210505208 | E452N2N50011A1L |
| 4211 | 2210505209 | E452N2N50011A1M |
| 4212 | 2210505210 | E452N2N50011C31 |
| 4213 | 2210505211 | E452N2N50011C32 |
| 4214 | 2210505212 | E452N2N50011C33 |
| 4215 | 2210505213 | E452N2N50011C34 |
| 4216 | 2210505214 | E452N2N50011C35 |
| 4217 | 2210505215 | E452N2N50011C3A |
| 4218 | 2210505216 | E452N2N50011C3B |
| 4219 | 2210505217 | E452N2N50011C3C |
| 4220 | 2210505218 | E452N2N50011C3D |
| 4221 | 2210505219 | E452N2N50011C3E |
| 4222 | 2210505220 | E452N2N50011C3G |
| 4223 | 2210505221 | E452N2N50011C3H |
| 4224 | 2210505222 | E452N2N50011C3K |
| 4225 | 2210505223 | E452N2N50011C3L |
| 4226 | 2210505224 | E452N2N50011C3M |
| 4227 | 2210505225 | E452N2N50011C41 |
| 4228 | 2210505226 | E452N2N50011C42 |
| 4229 | 2210505227 | E452N2N50011C43 |
| 4230 | 2210505228 | E452N2N50011C44 |
| 4231 | 2210505229 | E452N2N50011C45 |
| 4232 | 2210505230 | E452N2N50011C4A |
| 4233 | 2210505231 | E452N2N50011C4B |
| 4234 | 2210505232 | E452N2N50011C4C |
| 4235 | 2210505233 | E452N2N50011C4D |
| 4236 | 2210505234 | E452N2N50011C4E |
| 4237 | 2210505235 | E452N2N50011C4G |
| 4238 | 2210505236 | E452N2N50011C4K |
| 4239 | 2210505237 | E452N2N50011C4L |
| 4240 | 2210505238 | E452N2N50011C4M |

| Pos. | Molex PN: | Engineering No.: |
|------|------------|------------------|
| 4241 | 2210505243 | E452N2N50011E05 |
| 4242 | 2210505244 | E452N2N50011E0A |
| 4243 | 2210505245 | E452N2N50011E0B |
| 4244 | 2210505246 | E452N2N50011E0C |
| 4245 | 2210505247 | E452N2N50011E0D |
| 4246 | 2210505248 | E452N2N50011E0E |
| 4247 | 2210505249 | E452N2N50011E0G |
| 4248 | 2210505250 | E452N2N50011E0H |
| 4249 | 2210505251 | E452N2N50011E0K |
| 4250 | 2210505252 | E452N2N50011E0L |
| 4251 | 2210505253 | E452N2N50011E0M |
| 4252 | 2210505258 | E452N2N50011R05 |
| 4253 | 2210505269 | E452N2N50011R21 |
| 4254 | 2210505270 | E452N2N50011R22 |
| 4255 | 2210505271 | E452N2N50011R23 |
| 4256 | 2210505272 | E452N2N50011R24 |
| 4257 | 2210505273 | E452N2N50011R25 |
| 4258 | 2210505274 | E452N2N50011R2A |
| 4259 | 2210505275 | E452N2N50011R2B |
| 4260 | 2210505276 | E452N2N50011R2C |
| 4261 | 2210505277 | E452N2N50011R2D |
| 4262 | 2210505278 | E452N2N50011R2E |
| 4263 | 2210505279 | E452N2N50011R2G |
| 4264 | 2210505280 | E452N2N50011R2H |
| 4265 | 2210505281 | E452N2N50011R2K |
| 4266 | 2210505282 | E452N2N50011R2L |
| 4267 | 2210505283 | E452N2N50011R2M |
| 4268 | 2210505284 | E452N2N50011S01 |
| 4269 | 2210505285 | E452N2N50011S02 |
| 4270 | 2210505286 | E452N2N50011S03 |
| 4271 | 2210505287 | E452N2N50011S04 |
| 4272 | 2210505288 | E452N2N50011S05 |
| 4273 | 2210505289 | E452N2N50011S0A |
| 4274 | 2210505290 | E452N2N50011S0B |
| 4275 | 2210505291 | E452N2N50011S0C |
| 4276 | 2210505292 | E452N2N50011S0D |
| 4277 | 2210505293 | E452N2N50011S0E |
| 4278 | 2210505294 | E452N2N50011S0G |
| 4279 | 2210505295 | E452N2N50011S0H |
| 4280 | 2210505296 | E452N2N50011S0K |

| Pos. | Molex PN: | Engineering No.: |
|------|------------|------------------|
| 4281 | 2210505297 | E452N2N50011S0L |
| 4282 | 2210505298 | E452N2N50011S0M |
| 4283 | 2210505299 | E452N3N10011A13 |
| 4284 | 2210505300 | E452N3N10011A14 |
| 4285 | 2210505301 | E452N3N10011A15 |
| 4286 | 2210505302 | E452N3N10011A1A |
| 4287 | 2210505303 | E452N3N10011A1B |
| 4288 | 2210505304 | E452N3N10011A1C |
| 4289 | 2210505305 | E452N3N10011A1D |
| 4290 | 2210505306 | E452N3N10011A1E |
| 4291 | 2210505307 | E452N3N10011A1G |
| 4292 | 2210505308 | E452N3N10011A1H |
| 4293 | 2210505309 | E452N3N10011A1K |
| 4294 | 2210505310 | E452N3N10011A1L |
| 4295 | 2210505311 | E452N3N10011A1M |
| 4296 | 2210505312 | E452N3N10011C31 |
| 4297 | 2210505313 | E452N3N10011C32 |
| 4298 | 2210505314 | E452N3N10011C33 |
| 4299 | 2210505315 | E452N3N10011C34 |
| 4300 | 2210505316 | E452N3N10011C35 |
| 4301 | 2210505317 | E452N3N10011C3A |
| 4302 | 2210505318 | E452N3N10011C3B |
| 4303 | 2210505319 | E452N3N10011C3C |
| 4304 | 2210505320 | E452N3N10011C3D |
| 4305 | 2210505321 | E452N3N10011C3E |
| 4306 | 2210505322 | E452N3N10011C3H |
| 4307 | 2210505323 | E452N3N10011C3K |
| 4308 | 2210505324 | E452N3N10011C3L |
| 4309 | 2210505325 | E452N3N10011C3M |
| 4310 | 2210505326 | E452N3N10011C43 |
| 4311 | 2210505327 | E452N3N10011C44 |
| 4312 | 2210505328 | E452N3N10011C4A |
| 4313 | 2210505329 | E452N3N10011C4C |
| 4314 | 2210505330 | E452N3N10011C4D |
| 4315 | 2210505331 | E452N3N10011C4E |
| 4316 | 2210505332 | E452N3N10011C4G |
| 4317 | 2210505333 | E452N3N10011C4K |
| 4318 | 2210505338 | E452N3N10011E05 |
| 4319 | 2210505353 | E452N3N10011R05 |
| 4320 | 2210505364 | E452N3N10011R21 |

| | | | | | | | | | |
|---|--|-------|--|---|--|------------|--|---|--|
| THIS DRAWING CONTAINS INFORMATION THAT IS PROPRIETARY TO MOLEX ELECTRONIC TECHNOLOGIES, LLC AND SHOULD NOT BE USED WITHOUT WRITTEN PERMISSION | | | | | | | | | |
| DIMENSION UNITS | | SCALE | | CURRENT REV DESC: REVISION CREATED FOR REMOVING PRE-RELEASE STAMP | | | |  E452XXXXXXXXXX DIN FORM A EN 175301-803 | |
| mm | | NTS | | | | | | | |
| GENERAL TOLERANCES (UNLESS SPECIFIED) | | | | | | | | | |
| | | MM | | INCH | | | | | |
| 4 PLACES | | ± | | ± | | | | | |
| 3 PLACES | | ± | | ± | | | | | |
| 2 PLACES | | ± | | ± | | | | | |
| 1 PLACE | | ± | | ± | | | | | |
| 0 PLACES | | ± | | ± | | | | | |
| ANGULAR TOL | | ± ° | | | | | | | |
| DRAFT WHERE APPLICABLE MUST REMAIN WITHIN DIMENSIONS | | | | FIRST ANGLE PROJECTION | | DRAWING | | SERIES | |
| | | | |  | | A3-SIZE | | 121050 | |
| DOCUMENT STATUS | | P1 | | RELEASE DATE | | 2022/07/19 | | 09:04:35 | |
| | | 9 | | 8 | | 7 | | 6 | |
| | | 5 | | 4 | | 3 | | 2 | |
| | | 1 | | | | | | | |

TABLE 3 - PART LIST

| Pos. | Molex PN: | Engineering No.: |
|------|------------|------------------|
| 4321 | 2210505365 | E452N3N10011R22 |
| 4322 | 2210505366 | E452N3N10011R23 |
| 4323 | 2210505367 | E452N3N10011R24 |
| 4324 | 2210505368 | E452N3N10011R25 |
| 4325 | 2210505369 | E452N3N10011R2A |
| 4326 | 2210505370 | E452N3N10011R2B |
| 4327 | 2210505371 | E452N3N10011R2C |
| 4328 | 2210505372 | E452N3N10011R2D |
| 4329 | 2210505373 | E452N3N10011R2E |
| 4330 | 2210505374 | E452N3N10011R2G |
| 4331 | 2210505375 | E452N3N10011R2K |
| 4332 | 2210505376 | E452N3N10011R2L |
| 4333 | 2210505377 | E452N3N10011R2M |
| 4334 | 2210505378 | E452N3N10011S01 |
| 4335 | 2210505379 | E452N3N10011S02 |
| 4336 | 2210505380 | E452N3N10011S03 |
| 4337 | 2210505381 | E452N3N10011S04 |
| 4338 | 2210505382 | E452N3N10011S05 |
| 4339 | 2210505383 | E452N3N10011S0A |
| 4340 | 2210505384 | E452N3N10011S0B |
| 4341 | 2210505385 | E452N3N10011S0C |
| 4342 | 2210505386 | E452N3N10011S0D |
| 4343 | 2210505387 | E452N3N10011S0E |
| 4344 | 2210505388 | E452N3N10011S0G |
| 4345 | 2210505389 | E452N3N10011S0H |
| 4346 | 2210505390 | E452N3N10011S0K |
| 4347 | 2210505391 | E452N3N10011S0L |
| 4348 | 2210505392 | E452N3N10011S0M |
| 4349 | 2210505393 | E452N3N10K11000 |
| 4350 | 2210505394 | E452N3N10K11A11 |
| 4351 | 2210505395 | E452N3N10K11A12 |
| 4352 | 2210505396 | E452N3N10K11A13 |
| 4353 | 2210505397 | E452N3N10K11A14 |
| 4354 | 2210505398 | E452N3N10K11A15 |
| 4355 | 2210505399 | E452N3N10K11A1A |
| 4356 | 2210505400 | E452N3N10K11A1B |
| 4357 | 2210505401 | E452N3N10K11A1C |
| 4358 | 2210505402 | E452N3N10K11A1D |
| 4359 | 2210505403 | E452N3N10K11A1E |
| 4360 | 2210505404 | E452N3N10K11A1G |

| Pos. | Molex PN: | Engineering No.: |
|------|------------|------------------|
| 4361 | 2210505405 | E452N3N10K11A1H |
| 4362 | 2210505406 | E452N3N10K11A1K |
| 4363 | 2210505407 | E452N3N10K11A1L |
| 4364 | 2210505408 | E452N3N10K11A1M |
| 4365 | 2210505409 | E452N3N10K11C31 |
| 4366 | 2210505410 | E452N3N10K11C32 |
| 4367 | 2210505411 | E452N3N10K11C33 |
| 4368 | 2210505412 | E452N3N10K11C34 |
| 4369 | 2210505413 | E452N3N10K11C35 |
| 4370 | 2210505414 | E452N3N10K11C3A |
| 4371 | 2210505415 | E452N3N10K11C3B |
| 4372 | 2210505416 | E452N3N10K11C3C |
| 4373 | 2210505417 | E452N3N10K11C3D |
| 4374 | 2210505418 | E452N3N10K11C3E |
| 4375 | 2210505419 | E452N3N10K11C3G |
| 4376 | 2210505420 | E452N3N10K11C3H |
| 4377 | 2210505421 | E452N3N10K11C3K |
| 4378 | 2210505422 | E452N3N10K11C3L |
| 4379 | 2210505423 | E452N3N10K11C3M |
| 4380 | 2210505424 | E452N3N10K11C41 |
| 4381 | 2210505425 | E452N3N10K11C43 |
| 4382 | 2210505426 | E452N3N10K11C44 |
| 4383 | 2210505427 | E452N3N10K11C45 |
| 4384 | 2210505428 | E452N3N10K11C4A |
| 4385 | 2210505429 | E452N3N10K11C4B |
| 4386 | 2210505430 | E452N3N10K11C4C |
| 4387 | 2210505431 | E452N3N10K11C4D |
| 4388 | 2210505432 | E452N3N10K11C4E |
| 4389 | 2210505433 | E452N3N10K11C4G |
| 4390 | 2210505434 | E452N3N10K11C4K |
| 4391 | 2210505435 | E452N3N10K11C4M |
| 4392 | 2210505440 | E452N3N10K11E05 |
| 4393 | 2210505455 | E452N3N10K11R05 |
| 4394 | 2210505466 | E452N3N10K11R21 |
| 4395 | 2210505467 | E452N3N10K11R22 |
| 4396 | 2210505468 | E452N3N10K11R23 |
| 4397 | 2210505469 | E452N3N10K11R24 |
| 4398 | 2210505470 | E452N3N10K11R25 |
| 4399 | 2210505471 | E452N3N10K11R2A |
| 4400 | 2210505472 | E452N3N10K11R2B |

| Pos. | Molex PN: | Engineering No.: |
|------|------------|------------------|
| 4401 | 2210505473 | E452N3N10K11R2C |
| 4402 | 2210505474 | E452N3N10K11R2D |
| 4403 | 2210505475 | E452N3N10K11R2E |
| 4404 | 2210505476 | E452N3N10K11R2G |
| 4405 | 2210505477 | E452N3N10K11R2H |
| 4406 | 2210505478 | E452N3N10K11R2K |
| 4407 | 2210505479 | E452N3N10K11R2L |
| 4408 | 2210505480 | E452N3N10K11R2M |
| 4409 | 2210505481 | E452N3N10K11S01 |
| 4410 | 2210505482 | E452N3N10K11S03 |
| 4411 | 2210505483 | E452N3N10K11S04 |
| 4412 | 2210505484 | E452N3N10K11S05 |
| 4413 | 2210505485 | E452N3N10K11S0A |
| 4414 | 2210505486 | E452N3N10K11S0B |
| 4415 | 2210505487 | E452N3N10K11S0C |
| 4416 | 2210505488 | E452N3N10K11S0D |
| 4417 | 2210505489 | E452N3N10K11S0E |
| 4418 | 2210505490 | E452N3N10K11S0G |
| 4419 | 2210505491 | E452N3N10K11S0K |
| 4420 | 2210505492 | E452N3N10K11S0L |
| 4421 | 2210505493 | E452N3N10K11S0M |
| 4422 | 2210505494 | E452N3N15011000 |
| 4423 | 2210505495 | E452N3N15011A13 |
| 4424 | 2210505496 | E452N3N15011A14 |
| 4425 | 2210505497 | E452N3N15011A1A |
| 4426 | 2210505498 | E452N3N15011A1B |
| 4427 | 2210505499 | E452N3N15011A1C |
| 4428 | 2210505500 | E452N3N15011A1D |
| 4429 | 2210505501 | E452N3N15011A1E |
| 4430 | 2210505502 | E452N3N15011A1G |
| 4431 | 2210505503 | E452N3N15011A1H |
| 4432 | 2210505504 | E452N3N15011A1K |
| 4433 | 2210505505 | E452N3N15011A1L |
| 4434 | 2210505506 | E452N3N15011A1M |
| 4435 | 2210505507 | E452N3N15011C31 |
| 4436 | 2210505508 | E452N3N15011C33 |
| 4437 | 2210505509 | E452N3N15011C34 |
| 4438 | 2210505510 | E452N3N15011C35 |
| 4439 | 2210505511 | E452N3N15011C3B |
| 4440 | 2210505512 | E452N3N15011C3C |

| Pos. | Molex PN: | Engineering No.: |
|------|------------|------------------|
| 4441 | 2210505513 | E452N3N15011C3D |
| 4442 | 2210505514 | E452N3N15011C3E |
| 4443 | 2210505515 | E452N3N15011C3G |
| 4444 | 2210505516 | E452N3N15011C3H |
| 4445 | 2210505517 | E452N3N15011C3K |
| 4446 | 2210505518 | E452N3N15011C3L |
| 4447 | 2210505519 | E452N3N15011C3M |
| 4448 | 2210505520 | E452N3N15011C41 |
| 4449 | 2210505521 | E452N3N15011C42 |
| 4450 | 2210505522 | E452N3N15011C43 |
| 4451 | 2210505523 | E452N3N15011C44 |
| 4452 | 2210505524 | E452N3N15011C45 |
| 4453 | 2210505525 | E452N3N15011C4A |
| 4454 | 2210505526 | E452N3N15011C4B |
| 4455 | 2210505527 | E452N3N15011C4C |
| 4456 | 2210505528 | E452N3N15011C4D |
| 4457 | 2210505529 | E452N3N15011C4E |
| 4458 | 2210505530 | E452N3N15011C4G |
| 4459 | 2210505531 | E452N3N15011C4H |
| 4460 | 2210505532 | E452N3N15011C4K |
| 4461 | 2210505533 | E452N3N15011C4L |
| 4462 | 2210505534 | E452N3N15011C4M |
| 4463 | 2210505539 | E452N3N15011E05 |
| 4464 | 2210505554 | E452N3N15011R05 |
| 4465 | 2210505565 | E452N3N15011R21 |
| 4466 | 2210505566 | E452N3N15011R22 |
| 4467 | 2210505567 | E452N3N15011R23 |
| 4468 | 2210505568 | E452N3N15011R24 |
| 4469 | 2210505569 | E452N3N15011R25 |
| 4470 | 2210505570 | E452N3N15011R2A |
| 4471 | 2210505571 | E452N3N15011R2B |
| 4472 | 2210505572 | E452N3N15011R2C |
| 4473 | 2210505573 | E452N3N15011R2D |
| 4474 | 2210505574 | E452N3N15011R2E |
| 4475 | 2210505575 | E452N3N15011R2G |
| 4476 | 2210505576 | E452N3N15011R2H |
| 4477 | 2210505577 | E452N3N15011R2K |
| 4478 | 2210505578 | E452N3N15011R2L |
| 4479 | 2210505579 | E452N3N15011R2M |
| 4480 | 2210505580 | E452N3N15011S01 |

THIS DRAWING CONTAINS INFORMATION THAT IS PROPRIETARY TO MOLEX ELECTRONIC TECHNOLOGIES, LLC AND SHOULD NOT BE USED WITHOUT WRITTEN PERMISSION

| | | | | | | |
|--|---------------------|---|-----------------------------|----------------------------|-----------------|----------------|
| DIMENSION UNITS mm | SCALE NTS | CURRENT REV DESC: REVISION CREATED FOR REMOVING PRE-RELEASE STAMP | | molex | | |
| GENERAL TOLERANCES (UNLESS SPECIFIED) | | | | | | |
| 4 PLACES ± | MM | INCH | EC NO: 714567 | PRODUCT CUSTOMER DRAWING | | |
| 3 PLACES ± | | | DRWN: SUGEEB 2022/07/18 | DOCUMENT NUMBER | | |
| 2 PLACES ± | | | CHK'D: GGA 2022/07/19 | SD-121050-001 | | |
| 1 PLACE ± | | | APPR: GGA 2022/07/19 | DOC TYPE DOC PART REVISION | | |
| 0 PLACES ± | | | INITIAL REVISION: | PSD 001 E1 | | |
| ANGULAR TOL ± ° | | | DRWN: JMARSZALEK 2012/08/27 | | | |
| DRAFT WHERE APPLICABLE MUST REMAIN WITHIN DIMENSIONS | | | APPR: MDYSZEWSKA 2012/08/20 | | | |
| FIRST ANGLE PROJECTION | | | DRAWING | SERIES | MATERIAL NUMBER | CUSTOMER |
| | | | A3-SIZE | 121050 | SEE TABLE | GENERAL MARKET |
| | | | SHEET NUMBER | | 31 OF 41 | |

TABLE 3 - PART LIST

| Pos. | Molex PN: | Engineering No.: |
|------|------------|------------------|
| 4481 | 2210505581 | E452N3N15011S02 |
| 4482 | 2210505582 | E452N3N15011S03 |
| 4483 | 2210505583 | E452N3N15011S04 |
| 4484 | 2210505584 | E452N3N15011S05 |
| 4485 | 2210505585 | E452N3N15011S0A |
| 4486 | 2210505586 | E452N3N15011S0B |
| 4487 | 2210505587 | E452N3N15011S0C |
| 4488 | 2210505588 | E452N3N15011S0D |
| 4489 | 2210505589 | E452N3N15011S0E |
| 4490 | 2210505590 | E452N3N15011S0G |
| 4491 | 2210505591 | E452N3N15011S0H |
| 4492 | 2210505592 | E452N3N15011S0K |
| 4493 | 2210505593 | E452N3N15011S0L |
| 4494 | 2210505594 | E452N3N15011S0M |
| 4495 | 2210505595 | E452N3N20011000 |
| 4496 | 2210505596 | E452N3N20011A13 |
| 4497 | 2210505597 | E452N3N20011A15 |
| 4498 | 2210505598 | E452N3N20011A1A |
| 4499 | 2210505599 | E452N3N20011A1B |
| 4500 | 2210505600 | E452N3N20011A1C |
| 4501 | 2210505601 | E452N3N20011A1D |
| 4502 | 2210505602 | E452N3N20011A1E |
| 4503 | 2210505603 | E452N3N20011A1G |
| 4504 | 2210505604 | E452N3N20011A1K |
| 4505 | 2210505605 | E452N3N20011A1L |
| 4506 | 2210505606 | E452N3N20011A1M |
| 4507 | 2210505607 | E452N3N20011C31 |
| 4508 | 2210505608 | E452N3N20011C32 |
| 4509 | 2210505609 | E452N3N20011C33 |
| 4510 | 2210505610 | E452N3N20011C34 |
| 4511 | 2210505611 | E452N3N20011C35 |
| 4512 | 2210505612 | E452N3N20011C3A |
| 4513 | 2210505613 | E452N3N20011C3B |
| 4514 | 2210505614 | E452N3N20011C3C |
| 4515 | 2210505615 | E452N3N20011C3D |
| 4516 | 2210505616 | E452N3N20011C3E |
| 4517 | 2210505617 | E452N3N20011C3G |
| 4518 | 2210505618 | E452N3N20011C3H |
| 4519 | 2210505619 | E452N3N20011C3K |
| 4520 | 2210505620 | E452N3N20011C3L |

| Pos. | Molex PN: | Engineering No.: |
|------|------------|------------------|
| 4521 | 2210505621 | E452N3N20011C3M |
| 4522 | 2210505622 | E452N3N20011C43 |
| 4523 | 2210505623 | E452N3N20011C44 |
| 4524 | 2210505624 | E452N3N20011C45 |
| 4525 | 2210505625 | E452N3N20011C4A |
| 4526 | 2210505626 | E452N3N20011C4B |
| 4527 | 2210505627 | E452N3N20011C4C |
| 4528 | 2210505628 | E452N3N20011C4D |
| 4529 | 2210505629 | E452N3N20011C4E |
| 4530 | 2210505630 | E452N3N20011C4G |
| 4531 | 2210505631 | E452N3N20011C4K |
| 4532 | 2210505632 | E452N3N20011C4M |
| 4533 | 2210505637 | E452N3N20011E05 |
| 4534 | 2210505662 | E452N3N20011R21 |
| 4535 | 2210505663 | E452N3N20011R22 |
| 4536 | 2210505664 | E452N3N20011R23 |
| 4537 | 2210505665 | E452N3N20011R24 |
| 4538 | 2210505666 | E452N3N20011R25 |
| 4539 | 2210505667 | E452N3N20011R2A |
| 4540 | 2210505668 | E452N3N20011R2B |
| 4541 | 2210505669 | E452N3N20011R2C |
| 4542 | 2210505670 | E452N3N20011R2D |
| 4543 | 2210505671 | E452N3N20011R2E |
| 4544 | 2210505672 | E452N3N20011R2G |
| 4545 | 2210505673 | E452N3N20011R2K |
| 4546 | 2210505674 | E452N3N20011R2L |
| 4547 | 2210505675 | E452N3N20011S01 |
| 4548 | 2210505676 | E452N3N20011S02 |
| 4549 | 2210505677 | E452N3N20011S03 |
| 4550 | 2210505678 | E452N3N20011S04 |
| 4551 | 2210505679 | E452N3N20011S05 |
| 4552 | 2210505680 | E452N3N20011S0A |
| 4553 | 2210505681 | E452N3N20011S0B |
| 4554 | 2210505682 | E452N3N20011S0C |
| 4555 | 2210505683 | E452N3N20011S0D |
| 4556 | 2210505684 | E452N3N20011S0E |
| 4557 | 2210505685 | E452N3N20011S0G |
| 4558 | 2210505686 | E452N3N20011S0H |
| 4559 | 2210505687 | E452N3N20011S0K |
| 4560 | 2210505688 | E452N3N20011S0L |

| Pos. | Molex PN: | Engineering No.: |
|------|------------|------------------|
| 4561 | 2210505689 | E452N3N20011S0M |
| 4562 | 2210505690 | E452N3N30011000 |
| 4563 | 2210505691 | E452N3N30011A12 |
| 4564 | 2210505692 | E452N3N30011A13 |
| 4565 | 2210505693 | E452N3N30011A14 |
| 4566 | 2210505694 | E452N3N30011A15 |
| 4567 | 2210505695 | E452N3N30011A1A |
| 4568 | 2210505696 | E452N3N30011A1B |
| 4569 | 2210505697 | E452N3N30011A1C |
| 4570 | 2210505698 | E452N3N30011A1D |
| 4571 | 2210505699 | E452N3N30011A1E |
| 4572 | 2210505700 | E452N3N30011A1G |
| 4573 | 2210505701 | E452N3N30011A1K |
| 4574 | 2210505702 | E452N3N30011A1L |
| 4575 | 2210505703 | E452N3N30011A1M |
| 4576 | 2210505704 | E452N3N30011C31 |
| 4577 | 2210505705 | E452N3N30011C33 |
| 4578 | 2210505706 | E452N3N30011C34 |
| 4579 | 2210505707 | E452N3N30011C35 |
| 4580 | 2210505708 | E452N3N30011C3A |
| 4581 | 2210505709 | E452N3N30011C3B |
| 4582 | 2210505710 | E452N3N30011C3C |
| 4583 | 2210505711 | E452N3N30011C3D |
| 4584 | 2210505712 | E452N3N30011C3E |
| 4585 | 2210505713 | E452N3N30011C3G |
| 4586 | 2210505714 | E452N3N30011C3H |
| 4587 | 2210505715 | E452N3N30011C3K |
| 4588 | 2210505716 | E452N3N30011C3L |
| 4589 | 2210505717 | E452N3N30011C3M |
| 4590 | 2210505718 | E452N3N30011C43 |
| 4591 | 2210505719 | E452N3N30011C4A |
| 4592 | 2210505720 | E452N3N30011C4B |
| 4593 | 2210505721 | E452N3N30011C4C |
| 4594 | 2210505722 | E452N3N30011C4D |
| 4595 | 2210505723 | E452N3N30011C4E |
| 4596 | 2210505724 | E452N3N30011C4G |
| 4597 | 2210505725 | E452N3N30011C4K |
| 4598 | 2210505730 | E452N3N30011E05 |
| 4599 | 2210505745 | E452N3N30011R05 |
| 4600 | 2210505756 | E452N3N30011R21 |

| Pos. | Molex PN: | Engineering No.: |
|------|------------|------------------|
| 4601 | 2210505757 | E452N3N30011R23 |
| 4602 | 2210505758 | E452N3N30011R24 |
| 4603 | 2210505759 | E452N3N30011R25 |
| 4604 | 2210505760 | E452N3N30011R2A |
| 4605 | 2210505761 | E452N3N30011R2B |
| 4606 | 2210505762 | E452N3N30011R2C |
| 4607 | 2210505763 | E452N3N30011R2D |
| 4608 | 2210505764 | E452N3N30011R2E |
| 4609 | 2210505765 | E452N3N30011R2G |
| 4610 | 2210505766 | E452N3N30011R2K |
| 4611 | 2210505767 | E452N3N30011R2L |
| 4612 | 2210505768 | E452N3N30011R2M |
| 4613 | 2210505769 | E452N3N30011S01 |
| 4614 | 2210505770 | E452N3N30011S02 |
| 4615 | 2210505771 | E452N3N30011S03 |
| 4616 | 2210505772 | E452N3N30011S04 |
| 4617 | 2210505773 | E452N3N30011S05 |
| 4618 | 2210505774 | E452N3N30011S0A |
| 4619 | 2210505775 | E452N3N30011S0B |
| 4620 | 2210505776 | E452N3N30011S0C |
| 4621 | 2210505777 | E452N3N30011S0E |
| 4622 | 2210505778 | E452N3N30011S0G |
| 4623 | 2210505779 | E452N3N30011S0H |
| 4624 | 2210505780 | E452N3N30011S0K |
| 4625 | 2210505781 | E452N3N30011S0L |
| 4626 | 2210505782 | E452N3N30011S0M |
| 4627 | 2210505783 | E452N3N50011000 |
| 4628 | 2210505784 | E452N3N50011A11 |
| 4629 | 2210505785 | E452N3N50011A12 |
| 4630 | 2210505786 | E452N3N50011A13 |
| 4631 | 2210505787 | E452N3N50011A14 |
| 4632 | 2210505788 | E452N3N50011A15 |
| 4633 | 2210505789 | E452N3N50011A1A |
| 4634 | 2210505790 | E452N3N50011A1C |
| 4635 | 2210505791 | E452N3N50011A1D |
| 4636 | 2210505792 | E452N3N50011A1E |
| 4637 | 2210505793 | E452N3N50011A1G |
| 4638 | 2210505794 | E452N3N50011A1H |
| 4639 | 2210505795 | E452N3N50011A1K |
| 4640 | 2210505796 | E452N3N50011A1L |

| | | | | | | | | | |
|---|--|-------|--|---|--|------------------------|--|---|--|
| THIS DRAWING CONTAINS INFORMATION THAT IS PROPRIETARY TO MOLEX ELECTRONIC TECHNOLOGIES, LLC AND SHOULD NOT BE USED WITHOUT WRITTEN PERMISSION | | | | | | | | | |
| DIMENSION UNITS | | SCALE | | CURRENT REV DESC: REVISION CREATED FOR REMOVING PRE-RELEASE STAMP | | | |  | |
| mm | | NTS | | | | | | | |
| GENERAL TOLERANCES (UNLESS SPECIFIED) | | | | EC NO: 714567 | | 2022/07/18 | | E452XXXXXXXXXX DIN FORM A EN 175301-803 | |
| | | | | DRWN: SUGEEB | | 2022/07/19 | | PRODUCT CUSTOMER DRAWING | |
| | | | | CHK'D: GGA | | 2022/07/19 | | DOCUMENT NUMBER | |
| | | | | APPR: GGA | | 2022/07/19 | | DOC TYPE | |
| | | | | INITIAL REVISION: | | | | DOC PART | |
| | | | | DRWN: JMARSZALEK | | 2012/08/27 | | REVISION | |
| | | | | APPR: MDYSZEWSKA | | 2012/08/20 | | SD-121050-001 | |
| | | | | ANGULAR TOL | | | | PSD | |
| | | | | DRAFT WHERE APPLICABLE MUST REMAIN WITHIN DIMENSIONS | | FIRST ANGLE PROJECTION | | 001 | |
| | | | | | | DRAWING | | E1 | |
| | | | | | | SERIES | | 32 OF 41 | |
| | | | | | | MATERIAL NUMBER | | SEE TABLE | |
| | | | | | | CUSTOMER | | GENERAL MARKET | |

TABLE 3 - PART LIST

| Pos. | Molex PN: | Engineering No.: |
|------|------------|------------------|
| 4641 | 2210505797 | E452N3N50011A1M |
| 4642 | 2210505798 | E452N3N50011C31 |
| 4643 | 2210505799 | E452N3N50011C32 |
| 4644 | 2210505800 | E452N3N50011C33 |
| 4645 | 2210505801 | E452N3N50011C34 |
| 4646 | 2210505802 | E452N3N50011C35 |
| 4647 | 2210505803 | E452N3N50011C3A |
| 4648 | 2210505804 | E452N3N50011C3B |
| 4649 | 2210505805 | E452N3N50011C3C |
| 4650 | 2210505806 | E452N3N50011C3D |
| 4651 | 2210505807 | E452N3N50011C3E |
| 4652 | 2210505808 | E452N3N50011C3G |
| 4653 | 2210505809 | E452N3N50011C3K |
| 4654 | 2210505810 | E452N3N50011C3L |
| 4655 | 2210505811 | E452N3N50011C3M |
| 4656 | 2210505812 | E452N3N50011C41 |
| 4657 | 2210505813 | E452N3N50011C43 |
| 4658 | 2210505814 | E452N3N50011C45 |
| 4659 | 2210505815 | E452N3N50011C4A |
| 4660 | 2210505816 | E452N3N50011C4C |
| 4661 | 2210505817 | E452N3N50011C4G |
| 4662 | 2210505818 | E452N3N50011C4K |
| 4663 | 2210505823 | E452N3N50011E05 |
| 4664 | 2210505838 | E452N3N50011R05 |
| 4665 | 2210505849 | E452N3N50011R21 |
| 4666 | 2210505850 | E452N3N50011R22 |
| 4667 | 2210505851 | E452N3N50011R23 |
| 4668 | 2210505852 | E452N3N50011R24 |
| 4669 | 2210505853 | E452N3N50011R25 |
| 4670 | 2210505854 | E452N3N50011R2A |
| 4671 | 2210505855 | E452N3N50011R2B |
| 4672 | 2210505856 | E452N3N50011R2C |
| 4673 | 2210505857 | E452N3N50011R2D |
| 4674 | 2210505858 | E452N3N50011R2E |
| 4675 | 2210505859 | E452N3N50011R2G |
| 4676 | 2210505860 | E452N3N50011R2H |
| 4677 | 2210505861 | E452N3N50011R2K |
| 4678 | 2210505862 | E452N3N50011R2L |
| 4679 | 2210505863 | E452N3N50011R2M |
| 4680 | 2210505864 | E452N3N50011S01 |

| Pos. | Molex PN: | Engineering No.: |
|------|------------|------------------|
| 4681 | 2210505865 | E452N3N50011S03 |
| 4682 | 2210505866 | E452N3N50011S04 |
| 4683 | 2210505867 | E452N3N50011S05 |
| 4684 | 2210505868 | E452N3N50011S0A |
| 4685 | 2210505869 | E452N3N50011S0B |
| 4686 | 2210505870 | E452N3N50011S0C |
| 4687 | 2210505871 | E452N3N50011S0E |
| 4688 | 2210505872 | E452N3N50011S0G |
| 4689 | 2210505873 | E452N3N50011S0K |
| 4690 | 2210505874 | E452N3N50011S0L |
| 4691 | 2210505875 | E452N3N50011S0M |
| 4692 | 2210505876 | E452N4N10011000 |
| 4693 | 2210505877 | E452N4N10011A11 |
| 4694 | 2210505878 | E452N4N10011A12 |
| 4695 | 2210505879 | E452N4N10011A13 |
| 4696 | 2210505880 | E452N4N10011A14 |
| 4697 | 2210505881 | E452N4N10011A15 |
| 4698 | 2210505882 | E452N4N10011A1A |
| 4699 | 2210505883 | E452N4N10011A1B |
| 4700 | 2210505884 | E452N4N10011A1C |
| 4701 | 2210505885 | E452N4N10011A1D |
| 4702 | 2210505886 | E452N4N10011A1E |
| 4703 | 2210505887 | E452N4N10011A1G |
| 4704 | 2210505888 | E452N4N10011A1H |
| 4705 | 2210505889 | E452N4N10011A1K |
| 4706 | 2210505890 | E452N4N10011A1L |
| 4707 | 2210505891 | E452N4N10011A1M |
| 4708 | 2210505892 | E452N4N10011C31 |
| 4709 | 2210505893 | E452N4N10011C32 |
| 4710 | 2210505894 | E452N4N10011C33 |
| 4711 | 2210505895 | E452N4N10011C34 |
| 4712 | 2210505896 | E452N4N10011C35 |
| 4713 | 2210505897 | E452N4N10011C3A |
| 4714 | 2210505898 | E452N4N10011C3B |
| 4715 | 2210505899 | E452N4N10011C3C |
| 4716 | 2210505900 | E452N4N10011C3D |
| 4717 | 2210505901 | E452N4N10011C3E |
| 4718 | 2210505902 | E452N4N10011C3G |
| 4719 | 2210505903 | E452N4N10011C3H |
| 4720 | 2210505904 | E452N4N10011C3K |

| Pos. | Molex PN: | Engineering No.: |
|------|------------|------------------|
| 4721 | 2210505905 | E452N4N10011C3L |
| 4722 | 2210505906 | E452N4N10011C3M |
| 4723 | 2210505907 | E452N4N10011C41 |
| 4724 | 2210505908 | E452N4N10011C42 |
| 4725 | 2210505909 | E452N4N10011C43 |
| 4726 | 2210505910 | E452N4N10011C44 |
| 4727 | 2210505911 | E452N4N10011C45 |
| 4728 | 2210505912 | E452N4N10011C4A |
| 4729 | 2210505913 | E452N4N10011C4B |
| 4730 | 2210505914 | E452N4N10011C4C |
| 4731 | 2210505915 | E452N4N10011C4D |
| 4732 | 2210505916 | E452N4N10011C4E |
| 4733 | 2210505917 | E452N4N10011C4G |
| 4734 | 2210505918 | E452N4N10011C4H |
| 4735 | 2210505919 | E452N4N10011C4K |
| 4736 | 2210505920 | E452N4N10011C4L |
| 4737 | 2210505921 | E452N4N10011C4M |
| 4738 | 2210505926 | E452N4N10011E05 |
| 4739 | 2210505941 | E452N4N10011R05 |
| 4740 | 2210505952 | E452N4N10011R21 |
| 4741 | 2210505953 | E452N4N10011R22 |
| 4742 | 2210505954 | E452N4N10011R23 |
| 4743 | 2210505955 | E452N4N10011R24 |
| 4744 | 2210505956 | E452N4N10011R25 |
| 4745 | 2210505957 | E452N4N10011R2A |
| 4746 | 2210505958 | E452N4N10011R2B |
| 4747 | 2210505959 | E452N4N10011R2C |
| 4748 | 2210505960 | E452N4N10011R2D |
| 4749 | 2210505961 | E452N4N10011R2E |
| 4750 | 2210505962 | E452N4N10011R2G |
| 4751 | 2210505963 | E452N4N10011R2H |
| 4752 | 2210505964 | E452N4N10011R2K |
| 4753 | 2210505965 | E452N4N10011R2L |
| 4754 | 2210505966 | E452N4N10011R2M |
| 4755 | 2210505967 | E452N4N10011S01 |
| 4756 | 2210505968 | E452N4N10011S02 |
| 4757 | 2210505969 | E452N4N10011S03 |
| 4758 | 2210505970 | E452N4N10011S04 |
| 4759 | 2210505971 | E452N4N10011S05 |
| 4760 | 2210505972 | E452N4N10011S0A |

| Pos. | Molex PN: | Engineering No.: |
|------|------------|------------------|
| 4761 | 2210505973 | E452N4N10011S0B |
| 4762 | 2210505974 | E452N4N10011S0C |
| 4763 | 2210505975 | E452N4N10011S0D |
| 4764 | 2210505976 | E452N4N10011S0E |
| 4765 | 2210505977 | E452N4N10011S0G |
| 4766 | 2210505978 | E452N4N10011S0H |
| 4767 | 2210505979 | E452N4N10011S0K |
| 4768 | 2210505980 | E452N4N10011S0L |
| 4769 | 2210505981 | E452N4N10011S0M |
| 4770 | 2210505982 | E452N4N10K11000 |
| 4771 | 2210505983 | E452N4N10K11A11 |
| 4772 | 2210505984 | E452N4N10K11A12 |
| 4773 | 2210505985 | E452N4N10K11A13 |
| 4774 | 2210505986 | E452N4N10K11A14 |
| 4775 | 2210505987 | E452N4N10K11A15 |
| 4776 | 2210505988 | E452N4N10K11A1A |
| 4777 | 2210505989 | E452N4N10K11A1B |
| 4778 | 2210505990 | E452N4N10K11A1C |
| 4779 | 2210505991 | E452N4N10K11A1D |
| 4780 | 2210505992 | E452N4N10K11A1E |
| 4781 | 2210505993 | E452N4N10K11A1G |
| 4782 | 2210505994 | E452N4N10K11A1H |
| 4783 | 2210505995 | E452N4N10K11A1K |
| 4784 | 2210505996 | E452N4N10K11A1L |
| 4785 | 2210505997 | E452N4N10K11A1M |
| 4786 | 2210505998 | E452N4N10K11C31 |
| 4787 | 2210505999 | E452N4N10K11C32 |
| 4788 | 2210506000 | E452N4N10K11C33 |
| 4789 | 2210506001 | E452N4N10K11C34 |
| 4790 | 2210506002 | E452N4N10K11C35 |
| 4791 | 2210506003 | E452N4N10K11C3A |
| 4792 | 2210506004 | E452N4N10K11C3B |
| 4793 | 2210506005 | E452N4N10K11C3C |
| 4794 | 2210506006 | E452N4N10K11C3D |
| 4795 | 2210506007 | E452N4N10K11C3E |
| 4796 | 2210506008 | E452N4N10K11C3G |
| 4797 | 2210506009 | E452N4N10K11C3H |
| 4798 | 2210506010 | E452N4N10K11C3K |
| 4799 | 2210506011 | E452N4N10K11C3L |
| 4800 | 2210506012 | E452N4N10K11C3M |

| | | | | | | | | | |
|---|--|-------|--|---|--|------------|--|---|--|
| THIS DRAWING CONTAINS INFORMATION THAT IS PROPRIETARY TO MOLEX ELECTRONIC TECHNOLOGIES, LLC AND SHOULD NOT BE USED WITHOUT WRITTEN PERMISSION | | | | | | | | | |
| DIMENSION UNITS | | SCALE | | CURRENT REV DESC: REVISION CREATED FOR REMOVING PRE-RELEASE STAMP | | | |  E452XXXXXXXXXX DIN FORM A EN 175301-803 | |
| mm | | NTS | | | | | | | |
| GENERAL TOLERANCES (UNLESS SPECIFIED) | | | | EC NO: 714567 | | 2022/07/18 | | PRODUCT CUSTOMER DRAWING DOCUMENT NUMBER: SD-121050-001 DOC TYPE: PSD DOC PART: 001 REVISION: E1 | |
| | | | | DRWN: SUGEEB | | 2022/07/19 | | | |
| | | | | CHK'D: GGA | | 2022/07/19 | | | |
| | | | | APPR: GGA | | | | | |
| | | | | INITIAL REVISION: | | | | | |
| | | | | DRWN: JMARSZALEK | | 2012/08/27 | | | |
| | | | | APPR: MDYSZEWSKA | | 2012/08/20 | | | |
| DRAFT WHERE APPLICABLE MUST REMAIN WITHIN DIMENSIONS | | | | FIRST ANGLE PROJECTION | | DRAWING | | SHEET NUMBER | |
| | | | |  | | A3-SIZE | | 33 OF 41 | |

TABLE 3 - PART LIST

| Pos. | Molex PN: | Engineering No.: |
|------|------------|------------------|
| 4801 | 2210506013 | E452N4N10K11C41 |
| 4802 | 2210506014 | E452N4N10K11C42 |
| 4803 | 2210506015 | E452N4N10K11C43 |
| 4804 | 2210506016 | E452N4N10K11C44 |
| 4805 | 2210506017 | E452N4N10K11C45 |
| 4806 | 2210506018 | E452N4N10K11C4A |
| 4807 | 2210506019 | E452N4N10K11C4B |
| 4808 | 2210506020 | E452N4N10K11C4C |
| 4809 | 2210506021 | E452N4N10K11C4D |
| 4810 | 2210506022 | E452N4N10K11C4E |
| 4811 | 2210506023 | E452N4N10K11C4G |
| 4812 | 2210506024 | E452N4N10K11C4H |
| 4813 | 2210506025 | E452N4N10K11C4K |
| 4814 | 2210506026 | E452N4N10K11C4L |
| 4815 | 2210506027 | E452N4N10K11C4M |
| 4816 | 2210506032 | E452N4N10K11E05 |
| 4817 | 2210506047 | E452N4N10K11R05 |
| 4818 | 2210506058 | E452N4N10K11R21 |
| 4819 | 2210506059 | E452N4N10K11R22 |
| 4820 | 2210506060 | E452N4N10K11R23 |
| 4821 | 2210506061 | E452N4N10K11R24 |
| 4822 | 2210506062 | E452N4N10K11R25 |
| 4823 | 2210506063 | E452N4N10K11R2A |
| 4824 | 2210506064 | E452N4N10K11R2B |
| 4825 | 2210506065 | E452N4N10K11R2C |
| 4826 | 2210506066 | E452N4N10K11R2D |
| 4827 | 2210506067 | E452N4N10K11R2E |
| 4828 | 2210506068 | E452N4N10K11R2G |
| 4829 | 2210506069 | E452N4N10K11R2H |
| 4830 | 2210506070 | E452N4N10K11R2K |
| 4831 | 2210506071 | E452N4N10K11R2L |
| 4832 | 2210506072 | E452N4N10K11R2M |
| 4833 | 2210506073 | E452N4N10K11S01 |
| 4834 | 2210506074 | E452N4N10K11S02 |
| 4835 | 2210506075 | E452N4N10K11S03 |
| 4836 | 2210506076 | E452N4N10K11S04 |
| 4837 | 2210506077 | E452N4N10K11S05 |
| 4838 | 2210506078 | E452N4N10K11S0A |
| 4839 | 2210506079 | E452N4N10K11S0B |
| 4840 | 2210506080 | E452N4N10K11S0C |

| Pos. | Molex PN: | Engineering No.: |
|------|------------|------------------|
| 4841 | 2210506081 | E452N4N10K11S0D |
| 4842 | 2210506082 | E452N4N10K11S0E |
| 4843 | 2210506083 | E452N4N10K11S0G |
| 4844 | 2210506084 | E452N4N10K11S0H |
| 4845 | 2210506085 | E452N4N10K11S0K |
| 4846 | 2210506086 | E452N4N10K11S0L |
| 4847 | 2210506087 | E452N4N10K11S0M |
| 4848 | 2210506088 | E452N4N15011000 |
| 4849 | 2210506089 | E452N4N15011A11 |
| 4850 | 2210506090 | E452N4N15011A12 |
| 4851 | 2210506091 | E452N4N15011A13 |
| 4852 | 2210506092 | E452N4N15011A14 |
| 4853 | 2210506093 | E452N4N15011A15 |
| 4854 | 2210506094 | E452N4N15011A1A |
| 4855 | 2210506095 | E452N4N15011A1B |
| 4856 | 2210506096 | E452N4N15011A1C |
| 4857 | 2210506097 | E452N4N15011A1D |
| 4858 | 2210506098 | E452N4N15011A1E |
| 4859 | 2210506099 | E452N4N15011A1G |
| 4860 | 2210506100 | E452N4N15011A1H |
| 4861 | 2210506101 | E452N4N15011A1K |
| 4862 | 2210506102 | E452N4N15011A1L |
| 4863 | 2210506103 | E452N4N15011A1M |
| 4864 | 2210506104 | E452N4N15011C31 |
| 4865 | 2210506105 | E452N4N15011C32 |
| 4866 | 2210506106 | E452N4N15011C33 |
| 4867 | 2210506107 | E452N4N15011C34 |
| 4868 | 2210506108 | E452N4N15011C35 |
| 4869 | 2210506109 | E452N4N15011C3A |
| 4870 | 2210506110 | E452N4N15011C3B |
| 4871 | 2210506111 | E452N4N15011C3C |
| 4872 | 2210506112 | E452N4N15011C3D |
| 4873 | 2210506113 | E452N4N15011C3E |
| 4874 | 2210506114 | E452N4N15011C3G |
| 4875 | 2210506115 | E452N4N15011C3H |
| 4876 | 2210506116 | E452N4N15011C3K |
| 4877 | 2210506117 | E452N4N15011C3L |
| 4878 | 2210506118 | E452N4N15011C3M |
| 4879 | 2210506119 | E452N4N15011C41 |
| 4880 | 2210506120 | E452N4N15011C42 |

| Pos. | Molex PN: | Engineering No.: |
|------|------------|------------------|
| 4881 | 2210506121 | E452N4N15011C43 |
| 4882 | 2210506122 | E452N4N15011C44 |
| 4883 | 2210506123 | E452N4N15011C45 |
| 4884 | 2210506124 | E452N4N15011C4A |
| 4885 | 2210506125 | E452N4N15011C4B |
| 4886 | 2210506126 | E452N4N15011C4C |
| 4887 | 2210506127 | E452N4N15011C4D |
| 4888 | 2210506128 | E452N4N15011C4E |
| 4889 | 2210506129 | E452N4N15011C4G |
| 4890 | 2210506130 | E452N4N15011C4H |
| 4891 | 2210506131 | E452N4N15011C4K |
| 4892 | 2210506132 | E452N4N15011C4L |
| 4893 | 2210506133 | E452N4N15011C4M |
| 4894 | 2210506138 | E452N4N15011E05 |
| 4895 | 2210506153 | E452N4N15011R05 |
| 4896 | 2210506164 | E452N4N15011R21 |
| 4897 | 2210506165 | E452N4N15011R22 |
| 4898 | 2210506166 | E452N4N15011R23 |
| 4899 | 2210506167 | E452N4N15011R24 |
| 4900 | 2210506168 | E452N4N15011R25 |
| 4901 | 2210506169 | E452N4N15011R2A |
| 4902 | 2210506170 | E452N4N15011R2B |
| 4903 | 2210506171 | E452N4N15011R2C |
| 4904 | 2210506172 | E452N4N15011R2D |
| 4905 | 2210506173 | E452N4N15011R2E |
| 4906 | 2210506174 | E452N4N15011R2G |
| 4907 | 2210506175 | E452N4N15011R2H |
| 4908 | 2210506176 | E452N4N15011R2K |
| 4909 | 2210506177 | E452N4N15011R2L |
| 4910 | 2210506178 | E452N4N15011R2M |
| 4911 | 2210506179 | E452N4N15011S01 |
| 4912 | 2210506180 | E452N4N15011S02 |
| 4913 | 2210506181 | E452N4N15011S03 |
| 4914 | 2210506182 | E452N4N15011S04 |
| 4915 | 2210506183 | E452N4N15011S05 |
| 4916 | 2210506184 | E452N4N15011S0A |
| 4917 | 2210506185 | E452N4N15011S0B |
| 4918 | 2210506186 | E452N4N15011S0C |
| 4919 | 2210506187 | E452N4N15011S0D |
| 4920 | 2210506188 | E452N4N15011S0E |

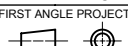
| Pos. | Molex PN: | Engineering No.: |
|------|------------|------------------|
| 4921 | 2210506189 | E452N4N15011S0G |
| 4922 | 2210506190 | E452N4N15011S0H |
| 4923 | 2210506191 | E452N4N15011S0K |
| 4924 | 2210506192 | E452N4N15011S0L |
| 4925 | 2210506193 | E452N4N15011S0M |
| 4926 | 2210506194 | E452N4N20011000 |
| 4927 | 2210506195 | E452N4N20011A11 |
| 4928 | 2210506196 | E452N4N20011A12 |
| 4929 | 2210506197 | E452N4N20011A13 |
| 4930 | 2210506198 | E452N4N20011A14 |
| 4931 | 2210506199 | E452N4N20011A15 |
| 4932 | 2210506200 | E452N4N20011A1A |
| 4933 | 2210506201 | E452N4N20011A1B |
| 4934 | 2210506202 | E452N4N20011A1C |
| 4935 | 2210506203 | E452N4N20011A1D |
| 4936 | 2210506204 | E452N4N20011A1E |
| 4937 | 2210506205 | E452N4N20011A1G |
| 4938 | 2210506206 | E452N4N20011A1H |
| 4939 | 2210506207 | E452N4N20011A1K |
| 4940 | 2210506208 | E452N4N20011A1L |
| 4941 | 2210506209 | E452N4N20011A1M |
| 4942 | 2210506210 | E452N4N20011C31 |
| 4943 | 2210506211 | E452N4N20011C32 |
| 4944 | 2210506212 | E452N4N20011C33 |
| 4945 | 2210506213 | E452N4N20011C34 |
| 4946 | 2210506214 | E452N4N20011C35 |
| 4947 | 2210506215 | E452N4N20011C3A |
| 4948 | 2210506216 | E452N4N20011C3B |
| 4949 | 2210506217 | E452N4N20011C3C |
| 4950 | 2210506218 | E452N4N20011C3D |
| 4951 | 2210506219 | E452N4N20011C3E |
| 4952 | 2210506220 | E452N4N20011C3G |
| 4953 | 2210506221 | E452N4N20011C3H |
| 4954 | 2210506222 | E452N4N20011C3K |
| 4955 | 2210506223 | E452N4N20011C3L |
| 4956 | 2210506224 | E452N4N20011C3M |
| 4957 | 2210506225 | E452N4N20011C41 |
| 4958 | 2210506226 | E452N4N20011C42 |
| 4959 | 2210506227 | E452N4N20011C43 |
| 4960 | 2210506228 | E452N4N20011C44 |

| | | | | | | | | | |
|---|--|-------|--|---|--|------------|--|---|--|
| THIS DRAWING CONTAINS INFORMATION THAT IS PROPRIETARY TO MOLEX ELECTRONIC TECHNOLOGIES, LLC AND SHOULD NOT BE USED WITHOUT WRITTEN PERMISSION | | | | | | | | | |
| DIMENSION UNITS | | SCALE | | CURRENT REV DESC: REVISION CREATED FOR REMOVING PRE-RELEASE STAMP | | | |  E452XXXXXXXXXX DIN FORM A EN 175301-803 | |
| mm | | NTS | | | | | | | |
| GENERAL TOLERANCES (UNLESS SPECIFIED) | | | | EC NO: 714567 | | 2022/07/18 | | PRODUCT CUSTOMER DRAWING DOCUMENT NUMBER: SD-121050-001 DOC TYPE: PSD DOC PART: 001 REVISION: E1 | |
| | | | | DRWN: SUGEEB | | 2022/07/19 | | | |
| | | | | CHK'D: GGA | | 2022/07/19 | | | |
| | | | | APPR: GGA | | | | | |
| | | | | INITIAL REVISION: | | | | | |
| | | | | DRWN: JMARSZALEK | | 2012/08/27 | | | |
| | | | | APPR: MDYSZEWSKA | | 2012/08/20 | | | |
| DRAFT WHERE APPLICABLE MUST REMAIN WITHIN DIMENSIONS | | | | FIRST ANGLE PROJECTION | | DRAWING | | SHEET NUMBER | |
| | | | |  | | A3-SIZE | | 34 OF 41 | |

TABLE 3 - PART LIST

| Pos. | Molex PN: | Engineering No.: |
|------|------------|------------------|
| 4961 | 2210506229 | E452N4N20011C45 |
| 4962 | 2210506230 | E452N4N20011C4A |
| 4963 | 2210506231 | E452N4N20011C4B |
| 4964 | 2210506232 | E452N4N20011C4C |
| 4965 | 2210506233 | E452N4N20011C4D |
| 4966 | 2210506234 | E452N4N20011C4E |
| 4967 | 2210506235 | E452N4N20011C4G |
| 4968 | 2210506236 | E452N4N20011C4H |
| 4969 | 2210506237 | E452N4N20011C4K |
| 4970 | 2210506238 | E452N4N20011C4L |
| 4971 | 2210506239 | E452N4N20011C4M |
| 4972 | 2210506244 | E452N4N20011E05 |
| 4973 | 2210506259 | E452N4N20011R05 |
| 4974 | 2210506270 | E452N4N20011R21 |
| 4975 | 2210506271 | E452N4N20011R22 |
| 4976 | 2210506272 | E452N4N20011R23 |
| 4977 | 2210506273 | E452N4N20011R24 |
| 4978 | 2210506274 | E452N4N20011R25 |
| 4979 | 2210506275 | E452N4N20011R2A |
| 4980 | 2210506276 | E452N4N20011R2B |
| 4981 | 2210506277 | E452N4N20011R2C |
| 4982 | 2210506278 | E452N4N20011R2D |
| 4983 | 2210506279 | E452N4N20011R2E |
| 4984 | 2210506280 | E452N4N20011R2G |
| 4985 | 2210506281 | E452N4N20011R2H |
| 4986 | 2210506282 | E452N4N20011R2K |
| 4987 | 2210506283 | E452N4N20011R2L |
| 4988 | 2210506284 | E452N4N20011R2M |
| 4989 | 2210506285 | E452N4N20011S01 |
| 4990 | 2210506286 | E452N4N20011S02 |
| 4991 | 2210506287 | E452N4N20011S03 |
| 4992 | 2210506288 | E452N4N20011S04 |
| 4993 | 2210506289 | E452N4N20011S05 |
| 4994 | 2210506290 | E452N4N20011S0A |
| 4995 | 2210506291 | E452N4N20011S0B |
| 4996 | 2210506292 | E452N4N20011S0C |
| 4997 | 2210506293 | E452N4N20011S0D |
| 4998 | 2210506294 | E452N4N20011S0E |
| 4999 | 2210506295 | E452N4N20011S0G |
| 5000 | 2210506296 | E452N4N20011S0H |

| Pos. | Molex PN: | Engineering No.: |
|------|------------|------------------|
| 5001 | 2210506297 | E452N4N20011S0K |
| 5002 | 2210506298 | E452N4N20011S0L |
| 5003 | 2210506299 | E452N4N20011S0M |
| 5004 | 2210506300 | E452N4N30011000 |
| 5005 | 2210506301 | E452N4N30011A11 |
| 5006 | 2210506302 | E452N4N30011A12 |
| 5007 | 2210506303 | E452N4N30011A13 |
| 5008 | 2210506304 | E452N4N30011A14 |
| 5009 | 2210506305 | E452N4N30011A15 |
| 5010 | 2210506306 | E452N4N30011A1A |
| 5011 | 2210506307 | E452N4N30011A1B |
| 5012 | 2210506308 | E452N4N30011A1C |
| 5013 | 2210506309 | E452N4N30011A1D |
| 5014 | 2210506310 | E452N4N30011A1E |
| 5015 | 2210506311 | E452N4N30011A1G |
| 5016 | 2210506312 | E452N4N30011A1H |
| 5017 | 2210506313 | E452N4N30011A1K |
| 5018 | 2210506314 | E452N4N30011A1L |
| 5019 | 2210506315 | E452N4N30011A1M |
| 5020 | 2210506316 | E452N4N30011C31 |
| 5021 | 2210506317 | E452N4N30011C32 |
| 5022 | 2210506318 | E452N4N30011C33 |
| 5023 | 2210506319 | E452N4N30011C34 |
| 5024 | 2210506320 | E452N4N30011C35 |
| 5025 | 2210506321 | E452N4N30011C3A |
| 5026 | 2210506322 | E452N4N30011C3B |
| 5027 | 2210506323 | E452N4N30011C3C |
| 5028 | 2210506324 | E452N4N30011C3D |
| 5029 | 2210506325 | E452N4N30011C3E |
| 5030 | 2210506326 | E452N4N30011C3G |
| 5031 | 2210506327 | E452N4N30011C3H |
| 5032 | 2210506328 | E452N4N30011C3K |
| 5033 | 2210506329 | E452N4N30011C3L |
| 5034 | 2210506330 | E452N4N30011C3M |
| 5035 | 2210506331 | E452N4N30011C41 |
| 5036 | 2210506332 | E452N4N30011C42 |
| 5037 | 2210506333 | E452N4N30011C43 |
| 5038 | 2210506334 | E452N4N30011C44 |
| 5039 | 2210506335 | E452N4N30011C45 |
| 5040 | 2210506336 | E452N4N30011C4A |

| Pos. | Molex PN: | Engineering No.: |
|------|------------|------------------|
| 5041 | 2210506337 | E452N4N30011C4B |
| 5042 | 2210506338 | E452N4N30011C4C |
| 5043 | 2210506339 | E452N4N30011C4D |
| 5044 | 2210506340 | E452N4N30011C4E |
| 5045 | 2210506341 | E452N4N30011C4G |
| 5046 | 2210506342 | E452N4N30011C4H |
| 5047 | 2210506343 | E452N4N30011C4K |
| 5048 | 2210506344 | E452N4N30011C4L |
| 5049 | 2210506345 | E452N4N30011C4M |
| 5050 | 2210506350 | E452N4N30011E05 |
| 5051 | 2210506365 | E452N4N30011R05 |
| 5052 | 2210506376 | E452N4N30011R21 |
| 5053 | 2210506377 | E452N4N30011R22 |
| 5054 | 2210506378 | E452N4N30011R23 |
| 5055 | 2210506379 | E452N4N30011R24 |
| 5056 | 2210506380 | E452N4N30011R25 |
| 5057 | 2210506381 | E452N4N30011R2A |
| 5058 | 2210506382 | E452N4N30011R2B |
| 5059 | 2210506383 | E452N4N30011R2C |
| 5060 | 2210506384 | E452N4N30011R2D |
| 5061 | 2210506385 | E452N4N30011R2E |
| 5062 | 2210506386 | E452N4N30011R2G |
| 5063 | 2210506387 | E452N4N30011R2H |
| 5064 | 2210506388 | E452N4N30011R2K |
| 5065 | 2210506389 | E452N4N30011R2L |
| 5066 | 2210506390 | E452N4N30011R2M |
| 5067 | 2210506391 | E452N4N30011S01 |
| 5068 | 2210506392 | E452N4N30011S02 |
| 5069 | 2210506393 | E452N4N30011S03 |
| 5070 | 2210506394 | E452N4N30011S04 |
| 5071 | 2210506395 | E452N4N30011S05 |
| 5072 | 2210506396 | E452N4N30011S0A |
| 5073 | 2210506397 | E452N4N30011S0B |
| 5074 | 2210506398 | E452N4N30011S0C |
| 5075 | 2210506399 | E452N4N30011S0D |
| 5076 | 2210506400 | E452N4N30011S0E |
| 5077 | 2210506401 | E452N4N30011S0G |
| 5078 | 2210506402 | E452N4N30011S0H |
| 5079 | 2210506403 | E452N4N30011S0K |
| 5080 | 2210506404 | E452N4N30011S0L |

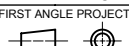
| Pos. | Molex PN: | Engineering No.: |
|------|------------|------------------|
| 5081 | 2210506405 | E452N4N30011S0M |
| 5082 | 2210506406 | E452N4N50011000 |
| 5083 | 2210506407 | E452N4N50011A11 |
| 5084 | 2210506408 | E452N4N50011A12 |
| 5085 | 2210506409 | E452N4N50011A13 |
| 5086 | 2210506410 | E452N4N50011A14 |
| 5087 | 2210506411 | E452N4N50011A15 |
| 5088 | 2210506412 | E452N4N50011A1A |
| 5089 | 2210506413 | E452N4N50011A1B |
| 5090 | 2210506414 | E452N4N50011A1C |
| 5091 | 2210506415 | E452N4N50011A1D |
| 5092 | 2210506416 | E452N4N50011A1E |
| 5093 | 2210506417 | E452N4N50011A1G |
| 5094 | 2210506418 | E452N4N50011A1H |
| 5095 | 2210506419 | E452N4N50011A1K |
| 5096 | 2210506420 | E452N4N50011A1L |
| 5097 | 2210506421 | E452N4N50011A1M |
| 5098 | 2210506422 | E452N4N50011C31 |
| 5099 | 2210506423 | E452N4N50011C32 |
| 5100 | 2210506424 | E452N4N50011C33 |
| 5101 | 2210506425 | E452N4N50011C34 |
| 5102 | 2210506426 | E452N4N50011C35 |
| 5103 | 2210506427 | E452N4N50011C3A |
| 5104 | 2210506428 | E452N4N50011C3B |
| 5105 | 2210506429 | E452N4N50011C3C |
| 5106 | 2210506430 | E452N4N50011C3D |
| 5107 | 2210506431 | E452N4N50011C3E |
| 5108 | 2210506432 | E452N4N50011C3G |
| 5109 | 2210506433 | E452N4N50011C3H |
| 5110 | 2210506434 | E452N4N50011C3K |
| 5111 | 2210506435 | E452N4N50011C3L |
| 5112 | 2210506436 | E452N4N50011C3M |
| 5113 | 2210506437 | E452N4N50011C41 |
| 5114 | 2210506438 | E452N4N50011C42 |
| 5115 | 2210506439 | E452N4N50011C43 |
| 5116 | 2210506440 | E452N4N50011C44 |
| 5117 | 2210506441 | E452N4N50011C45 |
| 5118 | 2210506442 | E452N4N50011C4A |
| 5119 | 2210506443 | E452N4N50011C4B |
| 5120 | 2210506444 | E452N4N50011C4C |

| | | | | | | | | | |
|---|--|-------|--|---|--|----------------|--|---|--|
| THIS DRAWING CONTAINS INFORMATION THAT IS PROPRIETARY TO MOLEX ELECTRONIC TECHNOLOGIES, LLC AND SHOULD NOT BE USED WITHOUT WRITTEN PERMISSION | | | | | | | | | |
| DIMENSION UNITS | | SCALE | | CURRENT REV DESC: REVISION CREATED FOR REMOVING PRE-RELEASE STAMP | | | |  E452XXXXXXXXXX DIN FORM A EN 175301-803 | |
| mm | | NTS | | | | | | | |
| GENERAL TOLERANCES (UNLESS SPECIFIED) | | | | EC NO: 714567 | | 2022/07/18 | | PRODUCT CUSTOMER DRAWING DOCUMENT NUMBER: SD-121050-001 DOC TYPE: PSD DOC PART: 001 REVISION: E1 | |
| | | | | DRWN: SUGEEB | | 2022/07/19 | | | |
| | | | | CHK'D: GGA | | 2022/07/19 | | | |
| | | | | APPR: GGA | | | | | |
| | | | | INITIAL REVISION: | | | | | |
| | | | | DRWN: JMARSZALEK | | 2012/08/27 | | | |
| | | | | APPR: MDYSZEWSKA | | 2012/08/20 | | | |
| DRAFT WHERE APPLICABLE MUST REMAIN WITHIN DIMENSIONS | | | | FIRST ANGLE PROJECTION | | DRAWING | | SERIES | |
| | | | |  | | A3-SIZE | | 121050 | |
| | | | | MATERIAL NUMBER | | CUSTOMER | | SHEET NUMBER | |
| | | | | SEE TABLE | | GENERAL MARKET | | 35 OF 41 | |

TABLE 3 - PART LIST

| Pos. | Molex PN: | Engineering No.: |
|------|------------|------------------|
| 5121 | 2210506445 | E452N4N50011C4D |
| 5122 | 2210506446 | E452N4N50011C4E |
| 5123 | 2210506447 | E452N4N50011C4G |
| 5124 | 2210506448 | E452N4N50011C4H |
| 5125 | 2210506449 | E452N4N50011C4K |
| 5126 | 2210506450 | E452N4N50011C4L |
| 5127 | 2210506451 | E452N4N50011C4M |
| 5128 | 2210506456 | E452N4N50011E05 |
| 5129 | 2210506471 | E452N4N50011R05 |
| 5130 | 2210506482 | E452N4N50011R21 |
| 5131 | 2210506483 | E452N4N50011R22 |
| 5132 | 2210506484 | E452N4N50011R23 |
| 5133 | 2210506485 | E452N4N50011R24 |
| 5134 | 2210506486 | E452N4N50011R25 |
| 5135 | 2210506487 | E452N4N50011R2A |
| 5136 | 2210506488 | E452N4N50011R2B |
| 5137 | 2210506489 | E452N4N50011R2C |
| 5138 | 2210506490 | E452N4N50011R2D |
| 5139 | 2210506491 | E452N4N50011R2E |
| 5140 | 2210506492 | E452N4N50011R2G |
| 5141 | 2210506493 | E452N4N50011R2H |
| 5142 | 2210506494 | E452N4N50011R2K |
| 5143 | 2210506495 | E452N4N50011R2L |
| 5144 | 2210506496 | E452N4N50011R2M |
| 5145 | 2210506497 | E452N4N50011S01 |
| 5146 | 2210506498 | E452N4N50011S02 |
| 5147 | 2210506499 | E452N4N50011S03 |
| 5148 | 2210506500 | E452N4N50011S04 |
| 5149 | 2210506501 | E452N4N50011S05 |
| 5150 | 2210506502 | E452N4N50011S0A |
| 5151 | 2210506503 | E452N4N50011S0B |
| 5152 | 2210506504 | E452N4N50011S0C |
| 5153 | 2210506505 | E452N4N50011S0D |
| 5154 | 2210506506 | E452N4N50011S0E |
| 5155 | 2210506507 | E452N4N50011S0G |
| 5156 | 2210506508 | E452N4N50011S0H |
| 5157 | 2210506509 | E452N4N50011S0K |
| 5158 | 2210506510 | E452N4N50011S0L |
| 5159 | 2210506511 | E452N4N50011S0M |
| 5160 | 2210506512 | E452P2N10011000 |

| Pos. | Molex PN: | Engineering No.: |
|------|------------|------------------|
| 5161 | 2210506513 | E452P2N10011A11 |
| 5162 | 2210506514 | E452P2N10011A12 |
| 5163 | 2210506515 | E452P2N10011A13 |
| 5164 | 2210506516 | E452P2N10011A14 |
| 5165 | 2210506517 | E452P2N10011A15 |
| 5166 | 2210506518 | E452P2N10011A1A |
| 5167 | 2210506519 | E452P2N10011A1B |
| 5168 | 2210506520 | E452P2N10011A1C |
| 5169 | 2210506521 | E452P2N10011A1D |
| 5170 | 2210506522 | E452P2N10011A1E |
| 5171 | 2210506523 | E452P2N10011A1G |
| 5172 | 2210506524 | E452P2N10011A1H |
| 5173 | 2210506525 | E452P2N10011A1K |
| 5174 | 2210506526 | E452P2N10011A1L |
| 5175 | 2210506527 | E452P2N10011A1M |
| 5176 | 2210506528 | E452P2N10011C31 |
| 5177 | 2210506529 | E452P2N10011C32 |
| 5178 | 2210506530 | E452P2N10011C33 |
| 5179 | 2210506531 | E452P2N10011C34 |
| 5180 | 2210506532 | E452P2N10011C35 |
| 5181 | 2210506533 | E452P2N10011C3A |
| 5182 | 2210506534 | E452P2N10011C3C |
| 5183 | 2210506535 | E452P2N10011C3D |
| 5184 | 2210506536 | E452P2N10011C3E |
| 5185 | 2210506537 | E452P2N10011C3G |
| 5186 | 2210506538 | E452P2N10011C3H |
| 5187 | 2210506539 | E452P2N10011C3K |
| 5188 | 2210506540 | E452P2N10011C3L |
| 5189 | 2210506541 | E452P2N10011C3M |
| 5190 | 2210506542 | E452P2N10011C41 |
| 5191 | 2210506543 | E452P2N10011C42 |
| 5192 | 2210506544 | E452P2N10011C43 |
| 5193 | 2210506545 | E452P2N10011C44 |
| 5194 | 2210506546 | E452P2N10011C45 |
| 5195 | 2210506547 | E452P2N10011C4A |
| 5196 | 2210506548 | E452P2N10011C4B |
| 5197 | 2210506549 | E452P2N10011C4C |
| 5198 | 2210506550 | E452P2N10011C4D |
| 5199 | 2210506551 | E452P2N10011C4E |
| 5200 | 2210506552 | E452P2N10011C4G |

| Pos. | Molex PN: | Engineering No.: |
|------|------------|------------------|
| 5201 | 2210506553 | E452P2N10011C4K |
| 5202 | 2210506554 | E452P2N10011C4L |
| 5203 | 2210506555 | E452P2N10011C4M |
| 5204 | 2210506560 | E452P2N10011E05 |
| 5205 | 2210506575 | E452P2N10011R05 |
| 5206 | 2210506586 | E452P2N10011R21 |
| 5207 | 2210506587 | E452P2N10011R22 |
| 5208 | 2210506588 | E452P2N10011R23 |
| 5209 | 2210506589 | E452P2N10011R24 |
| 5210 | 2210506590 | E452P2N10011R25 |
| 5211 | 2210506591 | E452P2N10011R2A |
| 5212 | 2210506592 | E452P2N10011R2B |
| 5213 | 2210506593 | E452P2N10011R2C |
| 5214 | 2210506594 | E452P2N10011R2D |
| 5215 | 2210506595 | E452P2N10011R2E |
| 5216 | 2210506596 | E452P2N10011R2G |
| 5217 | 2210506597 | E452P2N10011R2H |
| 5218 | 2210506598 | E452P2N10011R2K |
| 5219 | 2210506599 | E452P2N10011R2L |
| 5220 | 2210506600 | E452P2N10011R2M |
| 5221 | 2210506601 | E452P2N10011S01 |
| 5222 | 2210506602 | E452P2N10011S02 |
| 5223 | 2210506603 | E452P2N10011S03 |
| 5224 | 2210506604 | E452P2N10011S04 |
| 5225 | 2210506605 | E452P2N10011S05 |
| 5226 | 2210506606 | E452P2N10011S0A |
| 5227 | 2210506607 | E452P2N10011S0B |
| 5228 | 2210506608 | E452P2N10011S0C |
| 5229 | 2210506609 | E452P2N10011S0D |
| 5230 | 2210506610 | E452P2N10011S0E |
| 5231 | 2210506611 | E452P2N10011S0G |
| 5232 | 2210506612 | E452P2N10011S0H |
| 5233 | 2210506613 | E452P2N10011S0K |
| 5234 | 2210506614 | E452P2N10011S0L |
| 5235 | 2210506615 | E452P2N10011S0M |
| 5236 | 2210506616 | E452P2N10K11000 |
| 5237 | 2210506617 | E452P2N10K11A11 |
| 5238 | 2210506618 | E452P2N10K11A12 |
| 5239 | 2210506619 | E452P2N10K11A13 |
| 5240 | 2210506620 | E452P2N10K11A14 |

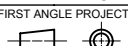
| Pos. | Molex PN: | Engineering No.: |
|------|------------|------------------|
| 5241 | 2210506621 | E452P2N10K11A15 |
| 5242 | 2210506622 | E452P2N10K11A1A |
| 5243 | 2210506623 | E452P2N10K11A1B |
| 5244 | 2210506624 | E452P2N10K11A1C |
| 5245 | 2210506625 | E452P2N10K11A1D |
| 5246 | 2210506626 | E452P2N10K11A1E |
| 5247 | 2210506627 | E452P2N10K11A1G |
| 5248 | 2210506628 | E452P2N10K11A1H |
| 5249 | 2210506629 | E452P2N10K11A1K |
| 5250 | 2210506630 | E452P2N10K11A1L |
| 5251 | 2210506631 | E452P2N10K11A1M |
| 5252 | 2210506632 | E452P2N10K11C31 |
| 5253 | 2210506633 | E452P2N10K11C32 |
| 5254 | 2210506634 | E452P2N10K11C33 |
| 5255 | 2210506635 | E452P2N10K11C34 |
| 5256 | 2210506636 | E452P2N10K11C35 |
| 5257 | 2210506637 | E452P2N10K11C3A |
| 5258 | 2210506638 | E452P2N10K11C3B |
| 5259 | 2210506639 | E452P2N10K11C3C |
| 5260 | 2210506640 | E452P2N10K11C3D |
| 5261 | 2210506641 | E452P2N10K11C3E |
| 5262 | 2210506642 | E452P2N10K11C3G |
| 5263 | 2210506643 | E452P2N10K11C3H |
| 5264 | 2210506644 | E452P2N10K11C3K |
| 5265 | 2210506645 | E452P2N10K11C3L |
| 5266 | 2210506646 | E452P2N10K11C3M |
| 5267 | 2210506647 | E452P2N10K11C41 |
| 5268 | 2210506648 | E452P2N10K11C42 |
| 5269 | 2210506649 | E452P2N10K11C43 |
| 5270 | 2210506650 | E452P2N10K11C44 |
| 5271 | 2210506651 | E452P2N10K11C45 |
| 5272 | 2210506652 | E452P2N10K11C4A |
| 5273 | 2210506653 | E452P2N10K11C4B |
| 5274 | 2210506654 | E452P2N10K11C4C |
| 5275 | 2210506655 | E452P2N10K11C4D |
| 5276 | 2210506656 | E452P2N10K11C4E |
| 5277 | 2210506657 | E452P2N10K11C4G |
| 5278 | 2210506658 | E452P2N10K11C4K |
| 5279 | 2210506659 | E452P2N10K11C4L |
| 5280 | 2210506660 | E452P2N10K11C4M |

| | | | | | | | | | |
|---|--|-------|--|---|--|------------------------|--|---|--|
| THIS DRAWING CONTAINS INFORMATION THAT IS PROPRIETARY TO MOLEX ELECTRONIC TECHNOLOGIES, LLC AND SHOULD NOT BE USED WITHOUT WRITTEN PERMISSION | | | | | | | | | |
| DIMENSION UNITS | | SCALE | | CURRENT REV DESC: REVISION CREATED FOR REMOVING PRE-RELEASE STAMP | | | |  | |
| mm | | NTS | | | | | | | |
| GENERAL TOLERANCES (UNLESS SPECIFIED) | | | | EC NO: 714567 | | 2022/07/18 | | E452XXXXXXXXXX | |
| | | | | DRWN: SUGEEB | | 2022/07/19 | | DIN FORM A EN 175301-803 | |
| | | | | CHK'D: GGA | | 2022/07/19 | | PRODUCT CUSTOMER DRAWING | |
| | | | | APPR: GGA | | 2022/07/19 | | DOCUMENT NUMBER | |
| | | | | INITIAL REVISION: | | | | DOC TYPE | |
| | | | | DRWN: JMARSZALEK | | 2012/08/27 | | DOC PART | |
| | | | | APPR: MDYSZEWSKA | | 2012/08/20 | | REVISION | |
| | | | | ANGULAR TOL | | | | SD-121050-001 | |
| | | | | DRAFT WHERE APPLICABLE MUST REMAIN WITHIN DIMENSIONS | | FIRST ANGLE PROJECTION | | PSD | |
| | | | | | | DRAWING | | 001 | |
| | | | | | | SERIES | | E1 | |
| | | | | | | MATERIAL NUMBER | | SEE TABLE | |
| | | | | | | CUSTOMER | | GENERAL MARKET | |
| | | | | | | SHEET NUMBER | | 36 OF 41 | |

TABLE 3 - PART LIST

| Pos. | Molex PN: | Engineering No.: |
|------|------------|------------------|
| 5281 | 2210506665 | E452P2N10K11E05 |
| 5282 | 2210506680 | E452P2N10K11R05 |
| 5283 | 2210506691 | E452P2N10K11R21 |
| 5284 | 2210506692 | E452P2N10K11R22 |
| 5285 | 2210506693 | E452P2N10K11R23 |
| 5286 | 2210506694 | E452P2N10K11R24 |
| 5287 | 2210506695 | E452P2N10K11R25 |
| 5288 | 2210506696 | E452P2N10K11R2A |
| 5289 | 2210506697 | E452P2N10K11R2B |
| 5290 | 2210506698 | E452P2N10K11R2C |
| 5291 | 2210506699 | E452P2N10K11R2D |
| 5292 | 2210506700 | E452P2N10K11R2E |
| 5293 | 2210506701 | E452P2N10K11R2G |
| 5294 | 2210506702 | E452P2N10K11R2H |
| 5295 | 2210506703 | E452P2N10K11R2K |
| 5296 | 2210506704 | E452P2N10K11R2L |
| 5297 | 2210506705 | E452P2N10K11R2M |
| 5298 | 2210506706 | E452P2N10K11S01 |
| 5299 | 2210506707 | E452P2N10K11S02 |
| 5300 | 2210506708 | E452P2N10K11S03 |
| 5301 | 2210506709 | E452P2N10K11S04 |
| 5302 | 2210506710 | E452P2N10K11S05 |
| 5303 | 2210506711 | E452P2N10K11S0A |
| 5304 | 2210506712 | E452P2N10K11S0B |
| 5305 | 2210506713 | E452P2N10K11S0C |
| 5306 | 2210506714 | E452P2N10K11S0D |
| 5307 | 2210506715 | E452P2N10K11S0E |
| 5308 | 2210506716 | E452P2N10K11S0G |
| 5309 | 2210506717 | E452P2N10K11S0K |
| 5310 | 2210506718 | E452P2N10K11S0L |
| 5311 | 2210506719 | E452P2N10K11S0M |
| 5312 | 2210506720 | E452P2N15011000 |
| 5313 | 2210506721 | E452P2N15011A11 |
| 5314 | 2210506722 | E452P2N15011A12 |
| 5315 | 2210506723 | E452P2N15011A13 |
| 5316 | 2210506724 | E452P2N15011A14 |
| 5317 | 2210506725 | E452P2N15011A15 |
| 5318 | 2210506726 | E452P2N15011A1A |
| 5319 | 2210506727 | E452P2N15011A1B |
| 5320 | 2210506728 | E452P2N15011A1C |

| Pos. | Molex PN: | Engineering No.: |
|------|------------|------------------|
| 5321 | 2210506729 | E452P2N15011A1D |
| 5322 | 2210506730 | E452P2N15011A1E |
| 5323 | 2210506731 | E452P2N15011A1G |
| 5324 | 2210506732 | E452P2N15011A1H |
| 5325 | 2210506733 | E452P2N15011A1K |
| 5326 | 2210506734 | E452P2N15011A1L |
| 5327 | 2210506735 | E452P2N15011A1M |
| 5328 | 2210506736 | E452P2N15011C31 |
| 5329 | 2210506737 | E452P2N15011C32 |
| 5330 | 2210506738 | E452P2N15011C33 |
| 5331 | 2210506739 | E452P2N15011C34 |
| 5332 | 2210506740 | E452P2N15011C35 |
| 5333 | 2210506741 | E452P2N15011C3A |
| 5334 | 2210506742 | E452P2N15011C3B |
| 5335 | 2210506743 | E452P2N15011C3C |
| 5336 | 2210506744 | E452P2N15011C3D |
| 5337 | 2210506745 | E452P2N15011C3E |
| 5338 | 2210506746 | E452P2N15011C3G |
| 5339 | 2210506747 | E452P2N15011C3H |
| 5340 | 2210506748 | E452P2N15011C3K |
| 5341 | 2210506749 | E452P2N15011C3L |
| 5342 | 2210506750 | E452P2N15011C3M |
| 5343 | 2210506751 | E452P2N15011C41 |
| 5344 | 2210506752 | E452P2N15011C42 |
| 5345 | 2210506753 | E452P2N15011C43 |
| 5346 | 2210506754 | E452P2N15011C44 |
| 5347 | 2210506755 | E452P2N15011C45 |
| 5348 | 2210506756 | E452P2N15011C4A |
| 5349 | 2210506757 | E452P2N15011C4B |
| 5350 | 2210506758 | E452P2N15011C4C |
| 5351 | 2210506759 | E452P2N15011C4D |
| 5352 | 2210506760 | E452P2N15011C4E |
| 5353 | 2210506761 | E452P2N15011C4G |
| 5354 | 2210506762 | E452P2N15011C4H |
| 5355 | 2210506763 | E452P2N15011C4K |
| 5356 | 2210506764 | E452P2N15011C4L |
| 5357 | 2210506765 | E452P2N15011C4M |
| 5358 | 2210506770 | E452P2N15011E05 |
| 5359 | 2210506785 | E452P2N15011R05 |
| 5360 | 2210506796 | E452P2N15011R21 |

| Pos. | Molex PN: | Engineering No.: |
|------|------------|------------------|
| 5361 | 2210506797 | E452P2N15011R22 |
| 5362 | 2210506798 | E452P2N15011R23 |
| 5363 | 2210506799 | E452P2N15011R24 |
| 5364 | 2210506800 | E452P2N15011R25 |
| 5365 | 2210506801 | E452P2N15011R2A |
| 5366 | 2210506802 | E452P2N15011R2B |
| 5367 | 2210506803 | E452P2N15011R2C |
| 5368 | 2210506804 | E452P2N15011R2D |
| 5369 | 2210506805 | E452P2N15011R2E |
| 5370 | 2210506806 | E452P2N15011R2G |
| 5371 | 2210506807 | E452P2N15011R2H |
| 5372 | 2210506808 | E452P2N15011R2K |
| 5373 | 2210506809 | E452P2N15011R2L |
| 5374 | 2210506810 | E452P2N15011R2M |
| 5375 | 2210506811 | E452P2N15011S01 |
| 5376 | 2210506812 | E452P2N15011S02 |
| 5377 | 2210506813 | E452P2N15011S03 |
| 5378 | 2210506814 | E452P2N15011S04 |
| 5379 | 2210506815 | E452P2N15011S05 |
| 5380 | 2210506816 | E452P2N15011S0A |
| 5381 | 2210506817 | E452P2N15011S0B |
| 5382 | 2210506818 | E452P2N15011S0C |
| 5383 | 2210506819 | E452P2N15011S0D |
| 5384 | 2210506820 | E452P2N15011S0E |
| 5385 | 2210506821 | E452P2N15011S0G |
| 5386 | 2210506822 | E452P2N15011S0H |
| 5387 | 2210506823 | E452P2N15011S0K |
| 5388 | 2210506824 | E452P2N15011S0L |
| 5389 | 2210506825 | E452P2N15011S0M |
| 5390 | 2210506826 | E452P2N20011000 |
| 5391 | 2210506827 | E452P2N20011A11 |
| 5392 | 2210506828 | E452P2N20011A13 |
| 5393 | 2210506829 | E452P2N20011A14 |
| 5394 | 2210506830 | E452P2N20011A15 |
| 5395 | 2210506831 | E452P2N20011A1A |
| 5396 | 2210506832 | E452P2N20011A1B |
| 5397 | 2210506833 | E452P2N20011A1C |
| 5398 | 2210506834 | E452P2N20011A1D |
| 5399 | 2210506835 | E452P2N20011A1E |
| 5400 | 2210506836 | E452P2N20011A1G |

| Pos. | Molex PN: | Engineering No.: |
|------|------------|------------------|
| 5401 | 2210506837 | E452P2N20011A1H |
| 5402 | 2210506838 | E452P2N20011A1K |
| 5403 | 2210506839 | E452P2N20011A1L |
| 5404 | 2210506840 | E452P2N20011A1M |
| 5405 | 2210506841 | E452P2N20011C31 |
| 5406 | 2210506842 | E452P2N20011C32 |
| 5407 | 2210506843 | E452P2N20011C33 |
| 5408 | 2210506844 | E452P2N20011C34 |
| 5409 | 2210506845 | E452P2N20011C35 |
| 5410 | 2210506846 | E452P2N20011C3A |
| 5411 | 2210506847 | E452P2N20011C3C |
| 5412 | 2210506848 | E452P2N20011C3D |
| 5413 | 2210506849 | E452P2N20011C3E |
| 5414 | 2210506850 | E452P2N20011C3G |
| 5415 | 2210506851 | E452P2N20011C3H |
| 5416 | 2210506852 | E452P2N20011C3K |
| 5417 | 2210506853 | E452P2N20011C3L |
| 5418 | 2210506854 | E452P2N20011C3M |
| 5419 | 2210506855 | E452P2N20011C41 |
| 5420 | 2210506856 | E452P2N20011C43 |
| 5421 | 2210506857 | E452P2N20011C44 |
| 5422 | 2210506858 | E452P2N20011C45 |
| 5423 | 2210506859 | E452P2N20011C4A |
| 5424 | 2210506860 | E452P2N20011C4B |
| 5425 | 2210506861 | E452P2N20011C4C |
| 5426 | 2210506862 | E452P2N20011C4D |
| 5427 | 2210506863 | E452P2N20011C4E |
| 5428 | 2210506864 | E452P2N20011C4G |
| 5429 | 2210506865 | E452P2N20011C4K |
| 5430 | 2210506866 | E452P2N20011C4L |
| 5431 | 2210506867 | E452P2N20011C4M |
| 5432 | 2210506872 | E452P2N20011E05 |
| 5433 | 2210506887 | E452P2N20011R05 |
| 5434 | 2210506898 | E452P2N20011R21 |
| 5435 | 2210506899 | E452P2N20011R22 |
| 5436 | 2210506900 | E452P2N20011R23 |
| 5437 | 2210506901 | E452P2N20011R24 |
| 5438 | 2210506902 | E452P2N20011R25 |
| 5439 | 2210506903 | E452P2N20011R2A |
| 5440 | 2210506904 | E452P2N20011R2B |

DOCUMENT STATUS | P1 | RELEASE DATE | 2022/07/19 09:04:35

| | | |
|---|-----------------|---|
| THIS DRAWING CONTAINS INFORMATION THAT IS PROPRIETARY TO MOLEX ELECTRONIC TECHNOLOGIES, LLC AND SHOULD NOT BE USED WITHOUT WRITTEN PERMISSION | | |
| DIMENSION UNITS: mm SCALE: NTS | | CURRENT REV DESC: REVISION CREATED FOR REMOVING PRE-RELEASE STAMP EC NO: 714567 DRWN: SUGEEB CHK'D: GGA APPR: GGA |
| GENERAL TOLERANCES (UNLESS SPECIFIED) | | |
| 4 PLACES ± | MM INCH | |
| 3 PLACES ± | | |
| 2 PLACES ± | | 2022/07/18 2022/07/19 2022/07/19 |
| 1 PLACE ± | | |
| 0 PLACES ± | | |
| ANGULAR TOL ± ° | | |
| DRAFT WHERE APPLICABLE MUST REMAIN WITHIN DIMENSIONS | | INITIAL REVISION: DRWN: JMARSZALEK APPR: MDYSZEWSKA 2012/08/27 2012/08/20 |
| FIRST ANGLE PROJECTION | DRAWING | |
| SERIES | MATERIAL NUMBER | |
| | | |
| E452XXXXXXXXXX DIN FORM A EN 175301-803 | | |
| PRODUCT CUSTOMER DRAWING | | |
| DOCUMENT NUMBER | DOC TYPE | DOC PART REVISION |
| SD-121050-001 | PSD | 001 E1 |
| CUSTOMER | SHEET NUMBER | |
| GENERAL MARKET | 37 OF 41 | |

TABLE 3 - PART LIST

| Pos. | Molex PN: | Engineering No.: |
|------|------------|------------------|
| 5441 | 2210506905 | E452P2N20011R2C |
| 5442 | 2210506906 | E452P2N20011R2D |
| 5443 | 2210506907 | E452P2N20011R2E |
| 5444 | 2210506908 | E452P2N20011R2G |
| 5445 | 2210506909 | E452P2N20011R2H |
| 5446 | 2210506910 | E452P2N20011R2K |
| 5447 | 2210506911 | E452P2N20011R2L |
| 5448 | 2210506912 | E452P2N20011R2M |
| 5449 | 2210506913 | E452P2N20011S01 |
| 5450 | 2210506914 | E452P2N20011S02 |
| 5451 | 2210506915 | E452P2N20011S03 |
| 5452 | 2210506916 | E452P2N20011S04 |
| 5453 | 2210506917 | E452P2N20011S05 |
| 5454 | 2210506918 | E452P2N20011S0A |
| 5455 | 2210506919 | E452P2N20011S0C |
| 5456 | 2210506920 | E452P2N20011S0D |
| 5457 | 2210506921 | E452P2N20011S0E |
| 5458 | 2210506922 | E452P2N20011S0G |
| 5459 | 2210506923 | E452P2N20011S0H |
| 5460 | 2210506924 | E452P2N20011S0K |
| 5461 | 2210506925 | E452P2N20011S0L |
| 5462 | 2210506926 | E452P2N20011S0M |
| 5463 | 2210506927 | E452P2N30011000 |
| 5464 | 2210506928 | E452P2N30011A11 |
| 5465 | 2210506929 | E452P2N30011A12 |
| 5466 | 2210506930 | E452P2N30011A13 |
| 5467 | 2210506931 | E452P2N30011A14 |
| 5468 | 2210506932 | E452P2N30011A15 |
| 5469 | 2210506933 | E452P2N30011A1A |
| 5470 | 2210506934 | E452P2N30011A1B |
| 5471 | 2210506935 | E452P2N30011A1C |
| 5472 | 2210506936 | E452P2N30011A1D |
| 5473 | 2210506937 | E452P2N30011A1E |
| 5474 | 2210506938 | E452P2N30011A1G |
| 5475 | 2210506939 | E452P2N30011A1H |
| 5476 | 2210506940 | E452P2N30011A1K |
| 5477 | 2210506941 | E452P2N30011A1L |
| 5478 | 2210506942 | E452P2N30011A1M |
| 5479 | 2210506943 | E452P2N30011C31 |
| 5480 | 2210506944 | E452P2N30011C32 |

| Pos. | Molex PN: | Engineering No.: |
|------|------------|------------------|
| 5481 | 2210506945 | E452P2N30011C33 |
| 5482 | 2210506946 | E452P2N30011C34 |
| 5483 | 2210506947 | E452P2N30011C35 |
| 5484 | 2210506948 | E452P2N30011C3A |
| 5485 | 2210506949 | E452P2N30011C3B |
| 5486 | 2210506950 | E452P2N30011C3C |
| 5487 | 2210506951 | E452P2N30011C3D |
| 5488 | 2210506952 | E452P2N30011C3E |
| 5489 | 2210506953 | E452P2N30011C3G |
| 5490 | 2210506954 | E452P2N30011C3H |
| 5491 | 2210506955 | E452P2N30011C3K |
| 5492 | 2210506956 | E452P2N30011C3L |
| 5493 | 2210506957 | E452P2N30011C3M |
| 5494 | 2210506958 | E452P2N30011C41 |
| 5495 | 2210506959 | E452P2N30011C42 |
| 5496 | 2210506960 | E452P2N30011C43 |
| 5497 | 2210506961 | E452P2N30011C44 |
| 5498 | 2210506962 | E452P2N30011C45 |
| 5499 | 2210506963 | E452P2N30011C4A |
| 5500 | 2210506964 | E452P2N30011C4B |
| 5501 | 2210506965 | E452P2N30011C4C |
| 5502 | 2210506966 | E452P2N30011C4D |
| 5503 | 2210506967 | E452P2N30011C4E |
| 5504 | 2210506968 | E452P2N30011C4G |
| 5505 | 2210506969 | E452P2N30011C4K |
| 5506 | 2210506970 | E452P2N30011C4M |
| 5507 | 2210506975 | E452P2N30011E05 |
| 5508 | 2210506990 | E452P2N30011R05 |
| 5509 | 2210507001 | E452P2N30011R21 |
| 5510 | 2210507002 | E452P2N30011R22 |
| 5511 | 2210507003 | E452P2N30011R23 |
| 5512 | 2210507004 | E452P2N30011R24 |
| 5513 | 2210507005 | E452P2N30011R25 |
| 5514 | 2210507006 | E452P2N30011R2A |
| 5515 | 2210507007 | E452P2N30011R2B |
| 5516 | 2210507008 | E452P2N30011R2C |
| 5517 | 2210507009 | E452P2N30011R2D |
| 5518 | 2210507010 | E452P2N30011R2E |
| 5519 | 2210507011 | E452P2N30011R2G |
| 5520 | 2210507012 | E452P2N30011R2H |

| Pos. | Molex PN: | Engineering No.: |
|------|------------|------------------|
| 5521 | 2210507013 | E452P2N30011R2K |
| 5522 | 2210507014 | E452P2N30011R2L |
| 5523 | 2210507015 | E452P2N30011R2M |
| 5524 | 2210507016 | E452P2N30011S01 |
| 5525 | 2210507017 | E452P2N30011S02 |
| 5526 | 2210507018 | E452P2N30011S03 |
| 5527 | 2210507019 | E452P2N30011S04 |
| 5528 | 2210507020 | E452P2N30011S05 |
| 5529 | 2210507021 | E452P2N30011S0A |
| 5530 | 2210507022 | E452P2N30011S0B |
| 5531 | 2210507023 | E452P2N30011S0C |
| 5532 | 2210507024 | E452P2N30011S0D |
| 5533 | 2210507025 | E452P2N30011S0E |
| 5534 | 2210507026 | E452P2N30011S0G |
| 5535 | 2210507027 | E452P2N30011S0K |
| 5536 | 2210507028 | E452P2N30011S0L |
| 5537 | 2210507029 | E452P2N30011S0M |
| 5538 | 2210507030 | E452P2N50011000 |
| 5539 | 2210507031 | E452P2N50011A11 |
| 5540 | 2210507032 | E452P2N50011A12 |
| 5541 | 2210507033 | E452P2N50011A13 |
| 5542 | 2210507034 | E452P2N50011A14 |
| 5543 | 2210507035 | E452P2N50011A15 |
| 5544 | 2210507036 | E452P2N50011A1A |
| 5545 | 2210507037 | E452P2N50011A1B |
| 5546 | 2210507038 | E452P2N50011A1C |
| 5547 | 2210507039 | E452P2N50011A1D |
| 5548 | 2210507040 | E452P2N50011A1E |
| 5549 | 2210507041 | E452P2N50011A1G |
| 5550 | 2210507042 | E452P2N50011A1H |
| 5551 | 2210507043 | E452P2N50011A1K |
| 5552 | 2210507044 | E452P2N50011A1L |
| 5553 | 2210507045 | E452P2N50011A1M |
| 5554 | 2210507046 | E452P2N50011C31 |
| 5555 | 2210507047 | E452P2N50011C32 |
| 5556 | 2210507048 | E452P2N50011C33 |
| 5557 | 2210507049 | E452P2N50011C34 |
| 5558 | 2210507050 | E452P2N50011C35 |
| 5559 | 2210507051 | E452P2N50011C3A |
| 5560 | 2210507052 | E452P2N50011C3B |

| Pos. | Molex PN: | Engineering No.: |
|------|------------|------------------|
| 5561 | 2210507053 | E452P2N50011C3C |
| 5562 | 2210507054 | E452P2N50011C3D |
| 5563 | 2210507055 | E452P2N50011C3E |
| 5564 | 2210507056 | E452P2N50011C3G |
| 5565 | 2210507057 | E452P2N50011C3H |
| 5566 | 2210507058 | E452P2N50011C3K |
| 5567 | 2210507059 | E452P2N50011C3L |
| 5568 | 2210507060 | E452P2N50011C3M |
| 5569 | 2210507061 | E452P2N50011C41 |
| 5570 | 2210507062 | E452P2N50011C43 |
| 5571 | 2210507063 | E452P2N50011C44 |
| 5572 | 2210507064 | E452P2N50011C45 |
| 5573 | 2210507065 | E452P2N50011C4A |
| 5574 | 2210507066 | E452P2N50011C4C |
| 5575 | 2210507067 | E452P2N50011C4D |
| 5576 | 2210507068 | E452P2N50011C4E |
| 5577 | 2210507069 | E452P2N50011C4K |
| 5578 | 2210507074 | E452P2N50011E05 |
| 5579 | 2210507089 | E452P2N50011R05 |
| 5580 | 2210507100 | E452P2N50011R21 |
| 5581 | 2210507101 | E452P2N50011R22 |
| 5582 | 2210507102 | E452P2N50011R23 |
| 5583 | 2210507103 | E452P2N50011R24 |
| 5584 | 2210507104 | E452P2N50011R25 |
| 5585 | 2210507105 | E452P2N50011R2A |
| 5586 | 2210507106 | E452P2N50011R2B |
| 5587 | 2210507107 | E452P2N50011R2C |
| 5588 | 2210507108 | E452P2N50011R2D |
| 5589 | 2210507109 | E452P2N50011R2E |
| 5590 | 2210507110 | E452P2N50011R2G |
| 5591 | 2210507111 | E452P2N50011R2H |
| 5592 | 2210507112 | E452P2N50011R2K |
| 5593 | 2210507113 | E452P2N50011R2L |
| 5594 | 2210507114 | E452P2N50011R2M |
| 5595 | 2210507115 | E452P2N50011S01 |
| 5596 | 2210507116 | E452P2N50011S02 |
| 5597 | 2210507117 | E452P2N50011S03 |
| 5598 | 2210507118 | E452P2N50011S04 |
| 5599 | 2210507119 | E452P2N50011S05 |
| 5600 | 2210507120 | E452P2N50011S0A |

| | | | | | | | |
|---|--|---|--|---|--|---|--|
| THIS DRAWING CONTAINS INFORMATION THAT IS PROPRIETARY TO MOLEX ELECTRONIC TECHNOLOGIES, LLC AND SHOULD NOT BE USED WITHOUT WRITTEN PERMISSION | | SCALE NTS | | CURRENT REV DESC: REVISION CREATED FOR REMOVING PRE-RELEASE STAMP | |  | |
| DIMENSION UNITS mm | | | | | | | |
| GENERAL TOLERANCES (UNLESS SPECIFIED) | | | | | | E452XXXXXXXXXX DIN FORM A EN 175301-803 | |
| | | | | | | PRODUCT CUSTOMER DRAWING | |
| 4 PLACES ± | | MM | | INCH | | DOCUMENT NUMBER | |
| 3 PLACES ± | | | | | | SD-121050-001 | |
| 2 PLACES ± | | | | | | DOC TYPE | |
| 1 PLACE ± | | | | | | PSD | |
| 0 PLACES ± | | | | | | DOC PART | |
| ANGULAR TOL ± ° | | | | | | REVISION | |
| DRAFT WHERE APPLICABLE MUST REMAIN WITHIN DIMENSIONS | | FIRST ANGLE PROJECTION | | DRAWING | | SERIES | |
| | |  | | A3-SIZE | | 121050 | |
| | | | | MATERIAL NUMBER | | CUSTOMER | |
| | | | | SEE TABLE | | GENERAL MARKET | |
| | | | | | | SHEET NUMBER | |
| | | | | | | 38 OF 41 | |

TABLE 3 - PART LIST

| Pos. | Molex PN: | Engineering No.: |
|------|------------|------------------|
| 5601 | 2210507121 | E452P2N50011S0B |
| 5602 | 2210507122 | E452P2N50011S0C |
| 5603 | 2210507123 | E452P2N50011S0D |
| 5604 | 2210507124 | E452P2N50011S0E |
| 5605 | 2210507125 | E452P2N50011S0G |
| 5606 | 2210507126 | E452P2N50011S0K |
| 5607 | 2210507127 | E452P2N50011S0L |
| 5608 | 2210507128 | E452P2N50011S0M |
| 5609 | 2210507129 | E452P3N10011000 |
| 5610 | 2210507130 | E452P3N10011A11 |
| 5611 | 2210507131 | E452P3N10011A12 |
| 5612 | 2210507132 | E452P3N10011A13 |
| 5613 | 2210507133 | E452P3N10011A14 |
| 5614 | 2210507134 | E452P3N10011A15 |
| 5615 | 2210507135 | E452P3N10011A1A |
| 5616 | 2210507136 | E452P3N10011A1B |
| 5617 | 2210507137 | E452P3N10011A1C |
| 5618 | 2210507138 | E452P3N10011A1D |
| 5619 | 2210507139 | E452P3N10011A1E |
| 5620 | 2210507140 | E452P3N10011A1G |
| 5621 | 2210507141 | E452P3N10011A1H |
| 5622 | 2210507142 | E452P3N10011A1K |
| 5623 | 2210507143 | E452P3N10011A1L |
| 5624 | 2210507144 | E452P3N10011A1M |
| 5625 | 2210507145 | E452P3N10011C31 |
| 5626 | 2210507146 | E452P3N10011C32 |
| 5627 | 2210507147 | E452P3N10011C33 |
| 5628 | 2210507148 | E452P3N10011C34 |
| 5629 | 2210507149 | E452P3N10011C35 |
| 5630 | 2210507150 | E452P3N10011C3A |
| 5631 | 2210507151 | E452P3N10011C3B |
| 5632 | 2210507152 | E452P3N10011C3C |
| 5633 | 2210507153 | E452P3N10011C3D |
| 5634 | 2210507154 | E452P3N10011C3E |
| 5635 | 2210507155 | E452P3N10011C3G |
| 5636 | 2210507156 | E452P3N10011C3H |
| 5637 | 2210507157 | E452P3N10011C3K |
| 5638 | 2210507158 | E452P3N10011C3L |
| 5639 | 2210507159 | E452P3N10011C3M |
| 5640 | 2210507160 | E452P3N10011C41 |

| Pos. | Molex PN: | Engineering No.: |
|------|------------|------------------|
| 5641 | 2210507161 | E452P3N10011C42 |
| 5642 | 2210507162 | E452P3N10011C43 |
| 5643 | 2210507163 | E452P3N10011C44 |
| 5644 | 2210507164 | E452P3N10011C45 |
| 5645 | 2210507165 | E452P3N10011C4A |
| 5646 | 2210507166 | E452P3N10011C4B |
| 5647 | 2210507167 | E452P3N10011C4C |
| 5648 | 2210507168 | E452P3N10011C4D |
| 5649 | 2210507169 | E452P3N10011C4E |
| 5650 | 2210507170 | E452P3N10011C4G |
| 5651 | 2210507171 | E452P3N10011C4K |
| 5652 | 2210507172 | E452P3N10011C4M |
| 5653 | 2210507177 | E452P3N10011E05 |
| 5654 | 2210507192 | E452P3N10011R05 |
| 5655 | 2210507203 | E452P3N10011R21 |
| 5656 | 2210507204 | E452P3N10011R22 |
| 5657 | 2210507205 | E452P3N10011R23 |
| 5658 | 2210507206 | E452P3N10011R24 |
| 5659 | 2210507207 | E452P3N10011R25 |
| 5660 | 2210507208 | E452P3N10011R2A |
| 5661 | 2210507209 | E452P3N10011R2C |
| 5662 | 2210507210 | E452P3N10011R2D |
| 5663 | 2210507211 | E452P3N10011R2G |
| 5664 | 2210507212 | E452P3N10011R2H |
| 5665 | 2210507213 | E452P3N10011R2K |
| 5666 | 2210507214 | E452P3N10011R2L |
| 5667 | 2210507215 | E452P3N10011R2M |
| 5668 | 2210507216 | E452P3N10011S01 |
| 5669 | 2210507217 | E452P3N10011S02 |
| 5670 | 2210507218 | E452P3N10011S03 |
| 5671 | 2210507219 | E452P3N10011S04 |
| 5672 | 2210507220 | E452P3N10011S05 |
| 5673 | 2210507221 | E452P3N10011S0A |
| 5674 | 2210507222 | E452P3N10011S0B |
| 5675 | 2210507223 | E452P3N10011S0C |
| 5676 | 2210507224 | E452P3N10011S0D |
| 5677 | 2210507225 | E452P3N10011S0E |
| 5678 | 2210507226 | E452P3N10011S0G |
| 5679 | 2210507227 | E452P3N10011S0H |
| 5680 | 2210507228 | E452P3N10011S0K |

| Pos. | Molex PN: | Engineering No.: |
|------|------------|------------------|
| 5681 | 2210507229 | E452P3N10011S0L |
| 5682 | 2210507230 | E452P3N10011S0M |
| 5683 | 2210507231 | E452P3N10K11000 |
| 5684 | 2210507232 | E452P3N10K11A11 |
| 5685 | 2210507233 | E452P3N10K11A12 |
| 5686 | 2210507234 | E452P3N10K11A13 |
| 5687 | 2210507235 | E452P3N10K11A14 |
| 5688 | 2210507236 | E452P3N10K11A15 |
| 5689 | 2210507237 | E452P3N10K11A1A |
| 5690 | 2210507238 | E452P3N10K11A1B |
| 5691 | 2210507239 | E452P3N10K11A1C |
| 5692 | 2210507240 | E452P3N10K11A1D |
| 5693 | 2210507241 | E452P3N10K11A1E |
| 5694 | 2210507242 | E452P3N10K11A1G |
| 5695 | 2210507243 | E452P3N10K11A1H |
| 5696 | 2210507244 | E452P3N10K11A1K |
| 5697 | 2210507245 | E452P3N10K11A1L |
| 5698 | 2210507246 | E452P3N10K11A1M |
| 5699 | 2210507247 | E452P3N10K11C31 |
| 5700 | 2210507248 | E452P3N10K11C32 |
| 5701 | 2210507249 | E452P3N10K11C33 |
| 5702 | 2210507250 | E452P3N10K11C34 |
| 5703 | 2210507251 | E452P3N10K11C35 |
| 5704 | 2210507252 | E452P3N10K11C3A |
| 5705 | 2210507253 | E452P3N10K11C3B |
| 5706 | 2210507254 | E452P3N10K11C3C |
| 5707 | 2210507255 | E452P3N10K11C3D |
| 5708 | 2210507256 | E452P3N10K11C3E |
| 5709 | 2210507257 | E452P3N10K11C3G |
| 5710 | 2210507258 | E452P3N10K11C3H |
| 5711 | 2210507259 | E452P3N10K11C3K |
| 5712 | 2210507260 | E452P3N10K11C3L |
| 5713 | 2210507261 | E452P3N10K11C3M |
| 5714 | 2210507262 | E452P3N10K11C41 |
| 5715 | 2210507263 | E452P3N10K11C42 |
| 5716 | 2210507264 | E452P3N10K11C43 |
| 5717 | 2210507265 | E452P3N10K11C44 |
| 5718 | 2210507266 | E452P3N10K11C45 |
| 5719 | 2210507267 | E452P3N10K11C4A |
| 5720 | 2210507268 | E452P3N10K11C4B |

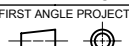
| Pos. | Molex PN: | Engineering No.: |
|------|------------|------------------|
| 5721 | 2210507269 | E452P3N10K11C4C |
| 5722 | 2210507270 | E452P3N10K11C4D |
| 5723 | 2210507271 | E452P3N10K11C4E |
| 5724 | 2210507272 | E452P3N10K11C4G |
| 5725 | 2210507273 | E452P3N10K11C4K |
| 5726 | 2210507274 | E452P3N10K11C4L |
| 5727 | 2210507275 | E452P3N10K11C4M |
| 5728 | 2210507280 | E452P3N10K11E05 |
| 5729 | 2210507295 | E452P3N10K11R05 |
| 5730 | 2210507306 | E452P3N10K11R21 |
| 5731 | 2210507307 | E452P3N10K11R22 |
| 5732 | 2210507308 | E452P3N10K11R23 |
| 5733 | 2210507309 | E452P3N10K11R24 |
| 5734 | 2210507310 | E452P3N10K11R25 |
| 5735 | 2210507311 | E452P3N10K11R2A |
| 5736 | 2210507312 | E452P3N10K11R2B |
| 5737 | 2210507313 | E452P3N10K11R2C |
| 5738 | 2210507314 | E452P3N10K11R2D |
| 5739 | 2210507315 | E452P3N10K11R2E |
| 5740 | 2210507316 | E452P3N10K11R2G |
| 5741 | 2210507317 | E452P3N10K11R2H |
| 5742 | 2210507318 | E452P3N10K11R2K |
| 5743 | 2210507319 | E452P3N10K11R2L |
| 5744 | 2210507320 | E452P3N10K11R2M |
| 5745 | 2210507321 | E452P3N10K11S01 |
| 5746 | 2210507322 | E452P3N10K11S02 |
| 5747 | 2210507323 | E452P3N10K11S03 |
| 5748 | 2210507324 | E452P3N10K11S04 |
| 5749 | 2210507325 | E452P3N10K11S05 |
| 5750 | 2210507326 | E452P3N10K11S0A |
| 5751 | 2210507327 | E452P3N10K11S0B |
| 5752 | 2210507328 | E452P3N10K11S0C |
| 5753 | 2210507329 | E452P3N10K11S0D |
| 5754 | 2210507330 | E452P3N10K11S0E |
| 5755 | 2210507331 | E452P3N10K11S0G |
| 5756 | 2210507332 | E452P3N10K11S0K |
| 5757 | 2210507333 | E452P3N10K11S0L |
| 5758 | 2210507334 | E452P3N10K11S0M |
| 5759 | 2210507335 | E452P3N15011000 |
| 5760 | 2210507336 | E452P3N15011A11 |

| | | | | | | | | | |
|---|--|-------|--|---|--|------------------------|--|---|--|
| THIS DRAWING CONTAINS INFORMATION THAT IS PROPRIETARY TO MOLEX ELECTRONIC TECHNOLOGIES, LLC AND SHOULD NOT BE USED WITHOUT WRITTEN PERMISSION | | | | | | | | | |
| DIMENSION UNITS | | SCALE | | CURRENT REV DESC: REVISION CREATED FOR REMOVING PRE-RELEASE STAMP | | | |  | |
| mm | | NTS | | | | | | | |
| GENERAL TOLERANCES (UNLESS SPECIFIED) | | | | EC NO: 714567 | | 2022/07/18 | | E452XXXXXXXXXX | |
| | | | | DRWN: SUGEEB | | 2022/07/19 | | DIN FORM A EN 175301-803 | |
| | | | | CHK'D: GGA | | 2022/07/19 | | PRODUCT CUSTOMER DRAWING | |
| | | | | APPR: GGA | | 2022/07/19 | | DOCUMENT NUMBER | |
| | | | | INITIAL REVISION: | | | | DOC TYPE | |
| | | | | DRWN: JMARSZALEK | | 2012/08/27 | | DOC PART | |
| | | | | APPR: MDYSZEWSKA | | 2012/08/20 | | REVISION | |
| | | | | ANGULAR TOL | | | | SD-121050-001 | |
| | | | | DRAFT WHERE APPLICABLE MUST REMAIN WITHIN DIMENSIONS | | FIRST ANGLE PROJECTION | | PSD | |
| | | | | | | DRAWING | | 001 | |
| | | | | | | SERIES | | E1 | |
| | | | | | | MATERIAL NUMBER | | SEE TABLE | |
| | | | | | | CUSTOMER | | GENERAL MARKET | |
| | | | | | | | | SHEET NUMBER | |
| | | | | | | | | 39 OF 41 | |

TABLE 3 - PART LIST

| Pos. | Molex PN: | Engineering No.: |
|------|------------|------------------|
| 5761 | 2210507337 | E452P3N15011A12 |
| 5762 | 2210507338 | E452P3N15011A13 |
| 5763 | 2210507339 | E452P3N15011A14 |
| 5764 | 2210507340 | E452P3N15011A15 |
| 5765 | 2210507341 | E452P3N15011A1A |
| 5766 | 2210507342 | E452P3N15011A1B |
| 5767 | 2210507343 | E452P3N15011A1C |
| 5768 | 2210507344 | E452P3N15011A1D |
| 5769 | 2210507345 | E452P3N15011A1E |
| 5770 | 2210507346 | E452P3N15011A1G |
| 5771 | 2210507347 | E452P3N15011A1H |
| 5772 | 2210507348 | E452P3N15011A1K |
| 5773 | 2210507349 | E452P3N15011A1L |
| 5774 | 2210507350 | E452P3N15011A1M |
| 5775 | 2210507351 | E452P3N15011C31 |
| 5776 | 2210507352 | E452P3N15011C32 |
| 5777 | 2210507353 | E452P3N15011C33 |
| 5778 | 2210507354 | E452P3N15011C34 |
| 5779 | 2210507355 | E452P3N15011C35 |
| 5780 | 2210507356 | E452P3N15011C3A |
| 5781 | 2210507357 | E452P3N15011C3B |
| 5782 | 2210507358 | E452P3N15011C3C |
| 5783 | 2210507359 | E452P3N15011C3D |
| 5784 | 2210507360 | E452P3N15011C3E |
| 5785 | 2210507361 | E452P3N15011C3G |
| 5786 | 2210507362 | E452P3N15011C3H |
| 5787 | 2210507363 | E452P3N15011C3K |
| 5788 | 2210507364 | E452P3N15011C3L |
| 5789 | 2210507365 | E452P3N15011C3M |
| 5790 | 2210507366 | E452P3N15011C41 |
| 5791 | 2210507367 | E452P3N15011C42 |
| 5792 | 2210507368 | E452P3N15011C43 |
| 5793 | 2210507369 | E452P3N15011C44 |
| 5794 | 2210507370 | E452P3N15011C45 |
| 5795 | 2210507371 | E452P3N15011C4A |
| 5796 | 2210507372 | E452P3N15011C4B |
| 5797 | 2210507373 | E452P3N15011C4C |
| 5798 | 2210507374 | E452P3N15011C4D |
| 5799 | 2210507375 | E452P3N15011C4E |
| 5800 | 2210507376 | E452P3N15011C4G |

| Pos. | Molex PN: | Engineering No.: |
|------|------------|------------------|
| 5801 | 2210507377 | E452P3N15011C4H |
| 5802 | 2210507378 | E452P3N15011C4K |
| 5803 | 2210507379 | E452P3N15011C4L |
| 5804 | 2210507380 | E452P3N15011C4M |
| 5805 | 2210507385 | E452P3N15011E05 |
| 5806 | 2210507400 | E452P3N15011R05 |
| 5807 | 2210507411 | E452P3N15011R21 |
| 5808 | 2210507412 | E452P3N15011R22 |
| 5809 | 2210507413 | E452P3N15011R23 |
| 5810 | 2210507414 | E452P3N15011R24 |
| 5811 | 2210507415 | E452P3N15011R25 |
| 5812 | 2210507416 | E452P3N15011R2A |
| 5813 | 2210507417 | E452P3N15011R2B |
| 5814 | 2210507418 | E452P3N15011R2C |
| 5815 | 2210507419 | E452P3N15011R2D |
| 5816 | 2210507420 | E452P3N15011R2E |
| 5817 | 2210507421 | E452P3N15011R2G |
| 5818 | 2210507422 | E452P3N15011R2H |
| 5819 | 2210507423 | E452P3N15011R2K |
| 5820 | 2210507424 | E452P3N15011R2L |
| 5821 | 2210507425 | E452P3N15011R2M |
| 5822 | 2210507426 | E452P3N15011S01 |
| 5823 | 2210507427 | E452P3N15011S02 |
| 5824 | 2210507428 | E452P3N15011S03 |
| 5825 | 2210507429 | E452P3N15011S04 |
| 5826 | 2210507430 | E452P3N15011S05 |
| 5827 | 2210507431 | E452P3N15011S0A |
| 5828 | 2210507432 | E452P3N15011S0B |
| 5829 | 2210507433 | E452P3N15011S0C |
| 5830 | 2210507434 | E452P3N15011S0D |
| 5831 | 2210507435 | E452P3N15011S0E |
| 5832 | 2210507436 | E452P3N15011S0G |
| 5833 | 2210507437 | E452P3N15011S0K |
| 5834 | 2210507438 | E452P3N15011S0L |
| 5835 | 2210507439 | E452P3N15011S0M |
| 5836 | 2210507440 | E452P3N20011000 |
| 5837 | 2210507441 | E452P3N20011A11 |
| 5838 | 2210507442 | E452P3N20011A12 |
| 5839 | 2210507443 | E452P3N20011A13 |
| 5840 | 2210507444 | E452P3N20011A14 |

| Pos. | Molex PN: | Engineering No.: |
|------|------------|------------------|
| 5841 | 2210507445 | E452P3N20011A15 |
| 5842 | 2210507446 | E452P3N20011A1A |
| 5843 | 2210507447 | E452P3N20011A1B |
| 5844 | 2210507448 | E452P3N20011A1C |
| 5845 | 2210507449 | E452P3N20011A1D |
| 5846 | 2210507450 | E452P3N20011A1E |
| 5847 | 2210507451 | E452P3N20011A1G |
| 5848 | 2210507452 | E452P3N20011A1H |
| 5849 | 2210507453 | E452P3N20011A1K |
| 5850 | 2210507454 | E452P3N20011A1L |
| 5851 | 2210507455 | E452P3N20011A1M |
| 5852 | 2210507456 | E452P3N20011C31 |
| 5853 | 2210507457 | E452P3N20011C32 |
| 5854 | 2210507458 | E452P3N20011C33 |
| 5855 | 2210507459 | E452P3N20011C34 |
| 5856 | 2210507460 | E452P3N20011C35 |
| 5857 | 2210507461 | E452P3N20011C3A |
| 5858 | 2210507462 | E452P3N20011C3B |
| 5859 | 2210507463 | E452P3N20011C3C |
| 5860 | 2210507464 | E452P3N20011C3D |
| 5861 | 2210507465 | E452P3N20011C3E |
| 5862 | 2210507466 | E452P3N20011C3G |
| 5863 | 2210507467 | E452P3N20011C3H |
| 5864 | 2210507468 | E452P3N20011C3K |
| 5865 | 2210507469 | E452P3N20011C3L |
| 5866 | 2210507470 | E452P3N20011C3M |
| 5867 | 2210507471 | E452P3N20011C41 |
| 5868 | 2210507472 | E452P3N20011C43 |
| 5869 | 2210507473 | E452P3N20011C45 |
| 5870 | 2210507474 | E452P3N20011C4A |
| 5871 | 2210507475 | E452P3N20011C4B |
| 5872 | 2210507476 | E452P3N20011C4C |
| 5873 | 2210507477 | E452P3N20011C4D |
| 5874 | 2210507478 | E452P3N20011C4E |
| 5875 | 2210507479 | E452P3N20011C4G |
| 5876 | 2210507480 | E452P3N20011C4H |
| 5877 | 2210507481 | E452P3N20011C4K |
| 5878 | 2210507482 | E452P3N20011C4M |
| 5879 | 2210507487 | E452P3N20011E05 |
| 5880 | 2210507502 | E452P3N20011R05 |

| Pos. | Molex PN: | Engineering No.: |
|------|------------|------------------|
| 5881 | 2210507513 | E452P3N20011R21 |
| 5882 | 2210507514 | E452P3N20011R22 |
| 5883 | 2210507515 | E452P3N20011R23 |
| 5884 | 2210507516 | E452P3N20011R24 |
| 5885 | 2210507517 | E452P3N20011R25 |
| 5886 | 2210507518 | E452P3N20011R2A |
| 5887 | 2210507519 | E452P3N20011R2B |
| 5888 | 2210507520 | E452P3N20011R2C |
| 5889 | 2210507521 | E452P3N20011R2D |
| 5890 | 2210507522 | E452P3N20011R2E |
| 5891 | 2210507523 | E452P3N20011R2G |
| 5892 | 2210507524 | E452P3N20011R2H |
| 5893 | 2210507525 | E452P3N20011R2K |
| 5894 | 2210507526 | E452P3N20011R2L |
| 5895 | 2210507527 | E452P3N20011R2M |
| 5896 | 2210507528 | E452P3N20011S01 |
| 5897 | 2210507529 | E452P3N20011S03 |
| 5898 | 2210507530 | E452P3N20011S04 |
| 5899 | 2210507531 | E452P3N20011S05 |
| 5900 | 2210507532 | E452P3N20011S0A |
| 5901 | 2210507533 | E452P3N20011S0B |
| 5902 | 2210507534 | E452P3N20011S0C |
| 5903 | 2210507535 | E452P3N20011S0D |
| 5904 | 2210507536 | E452P3N20011S0E |
| 5905 | 2210507537 | E452P3N20011S0G |
| 5906 | 2210507538 | E452P3N20011S0H |
| 5907 | 2210507539 | E452P3N20011S0K |
| 5908 | 2210507540 | E452P3N20011S0L |
| 5909 | 2210507541 | E452P3N20011S0M |
| 5910 | 2210507542 | E452P3N30011000 |
| 5911 | 2210507543 | E452P3N30011A11 |
| 5912 | 2210507544 | E452P3N30011A12 |
| 5913 | 2210507545 | E452P3N30011A13 |
| 5914 | 2210507546 | E452P3N30011A14 |
| 5915 | 2210507547 | E452P3N30011A15 |
| 5916 | 2210507548 | E452P3N30011A1A |
| 5917 | 2210507549 | E452P3N30011A1B |
| 5918 | 2210507550 | E452P3N30011A1C |
| 5919 | 2210507551 | E452P3N30011A1D |
| 5920 | 2210507552 | E452P3N30011A1E |

| | | | | | | | | | |
|---|--|----------|--|---|--|--------------|--|---|--|
| THIS DRAWING CONTAINS INFORMATION THAT IS PROPRIETARY TO MOLEX ELECTRONIC TECHNOLOGIES, LLC AND SHOULD NOT BE USED WITHOUT WRITTEN PERMISSION | | | | | | | | | |
| DIMENSION UNITS | | SCALE | | CURRENT REV DESC: REVISION CREATED FOR REMOVING PRE-RELEASE STAMP | | | |  E452XXXXXXXXXX DIN FORM A EN 175301-803 | |
| mm | | NTS | | | | | | | |
| GENERAL TOLERANCES (UNLESS SPECIFIED) | | | | | | | | | |
| | | MM | | INCH | | | | | |
| 4 PLACES | | ± | | ± | | | | | |
| 3 PLACES | | ± | | ± | | | | | |
| 2 PLACES | | ± | | ± | | | | | |
| 1 PLACE | | ± | | ± | | | | | |
| 0 PLACES | | ± | | ± | | | | | |
| ANGULAR TOL | | ± ° | | | | | | | |
| DRAFT WHERE APPLICABLE MUST REMAIN WITHIN DIMENSIONS | | | | FIRST ANGLE PROJECTION | | DRAWING | | SERIES | |
| | | | |  | | A3-SIZE | | 121050 | |
| DOCUMENT STATUS | | | | P1 | | RELEASE DATE | | 2022/07/19 09:04:35 | |
| DOCUMENT NUMBER | | DOC TYPE | | DOC PART | | REVISION | | | |
| SD-121050-001 | | PSD | | 001 | | E1 | | | |
| MATERIAL NUMBER | | | | CUSTOMER | | SHEET NUMBER | | | |
| SEE TABLE | | | | GENERAL MARKET | | 40 OF 41 | | | |

TABLE 3 - PART LIST

| Pos. | Molex PN: | Engineering No.: |
|------|------------|------------------|
| 5921 | 2210507553 | E452P3N30011A1G |
| 5922 | 2210507554 | E452P3N30011A1H |
| 5923 | 2210507555 | E452P3N30011A1K |
| 5924 | 2210507556 | E452P3N30011A1L |
| 5925 | 2210507557 | E452P3N30011A1M |
| 5926 | 2210507558 | E452P3N30011C31 |
| 5927 | 2210507559 | E452P3N30011C32 |
| 5928 | 2210507560 | E452P3N30011C33 |
| 5929 | 2210507561 | E452P3N30011C34 |
| 5930 | 2210507562 | E452P3N30011C35 |
| 5931 | 2210507563 | E452P3N30011C3A |
| 5932 | 2210507564 | E452P3N30011C3B |
| 5933 | 2210507565 | E452P3N30011C3C |
| 5934 | 2210507566 | E452P3N30011C3D |
| 5935 | 2210507567 | E452P3N30011C3E |
| 5936 | 2210507568 | E452P3N30011C3G |
| 5937 | 2210507569 | E452P3N30011C3K |
| 5938 | 2210507570 | E452P3N30011C3L |
| 5939 | 2210507571 | E452P3N30011C3M |
| 5940 | 2210507572 | E452P3N30011C41 |
| 5941 | 2210507573 | E452P3N30011C42 |
| 5942 | 2210507574 | E452P3N30011C43 |
| 5943 | 2210507575 | E452P3N30011C44 |
| 5944 | 2210507576 | E452P3N30011C45 |
| 5945 | 2210507577 | E452P3N30011C4A |
| 5946 | 2210507578 | E452P3N30011C4B |
| 5947 | 2210507579 | E452P3N30011C4C |
| 5948 | 2210507580 | E452P3N30011C4D |
| 5949 | 2210507581 | E452P3N30011C4E |
| 5950 | 2210507582 | E452P3N30011C4G |
| 5951 | 2210507583 | E452P3N30011C4K |
| 5952 | N/A | N/A |
| 5953 | 2210507589 | E452P3N30011E05 |
| 5954 | 2210507604 | E452P3N30011R05 |
| 5955 | 2210507615 | E452P3N30011R21 |
| 5956 | 2210507616 | E452P3N30011R22 |
| 5957 | 2210507617 | E452P3N30011R23 |
| 5958 | 2210507618 | E452P3N30011R24 |
| 5959 | 2210507619 | E452P3N30011R25 |
| 5960 | 2210507620 | E452P3N30011R2A |

| Pos. | Molex PN: | Engineering No.: |
|------|------------|------------------|
| 5961 | 2210507621 | E452P3N30011R2B |
| 5962 | 2210507622 | E452P3N30011R2C |
| 5963 | 2210507623 | E452P3N30011R2D |
| 5964 | 2210507624 | E452P3N30011R2E |
| 5965 | 2210507625 | E452P3N30011R2G |
| 5966 | 2210507626 | E452P3N30011R2H |
| 5967 | 2210507627 | E452P3N30011R2K |
| 5968 | 2210507628 | E452P3N30011R2L |
| 5969 | 2210507629 | E452P3N30011R2M |
| 5970 | 2210507630 | E452P3N30011S01 |
| 5971 | 2210507631 | E452P3N30011S02 |
| 5972 | 2210507632 | E452P3N30011S03 |
| 5973 | 2210507633 | E452P3N30011S04 |
| 5974 | 2210507634 | E452P3N30011S05 |
| 5975 | 2210507635 | E452P3N30011S0A |
| 5976 | 2210507636 | E452P3N30011S0C |
| 5977 | 2210507637 | E452P3N30011S0D |
| 5978 | 2210507638 | E452P3N30011S0E |
| 5979 | 2210507639 | E452P3N30011S0G |
| 5980 | 2210507640 | E452P3N30011S0K |
| 5981 | 2210507641 | E452P3N30011S0L |
| 5982 | 2210507642 | E452P3N30011S0M |
| 5983 | 2210507643 | E452P3N50011000 |
| 5984 | 2210507644 | E452P3N50011A11 |
| 5985 | 2210507645 | E452P3N50011A12 |
| 5986 | 2210507646 | E452P3N50011A13 |
| 5987 | 2210507647 | E452P3N50011A14 |
| 5988 | 2210507648 | E452P3N50011A15 |
| 5989 | 2210507649 | E452P3N50011A1A |
| 5990 | 2210507650 | E452P3N50011A1B |
| 5991 | 2210507651 | E452P3N50011A1C |
| 5992 | 2210507652 | E452P3N50011A1D |
| 5993 | 2210507653 | E452P3N50011A1E |
| 5994 | 2210507654 | E452P3N50011A1G |
| 5995 | 2210507655 | E452P3N50011A1K |
| 5996 | 2210507656 | E452P3N50011A1L |
| 5997 | 2210507657 | E452P3N50011A1M |
| 5998 | 2210507658 | E452P3N50011C31 |
| 5999 | 2210507659 | E452P3N50011C32 |
| 6000 | 2210507660 | E452P3N50011C33 |

| Pos. | Molex PN: | Engineering No.: |
|------|------------|------------------|
| 6001 | 2210507661 | E452P3N50011C34 |
| 6002 | 2210507662 | E452P3N50011C35 |
| 6003 | 2210507663 | E452P3N50011C3A |
| 6004 | 2210507664 | E452P3N50011C3B |
| 6005 | 2210507665 | E452P3N50011C3C |
| 6006 | 2210507666 | E452P3N50011C3D |
| 6007 | 2210507667 | E452P3N50011C3E |
| 6008 | 2210507668 | E452P3N50011C3G |
| 6009 | 2210507669 | E452P3N50011C3K |
| 6010 | 2210507670 | E452P3N50011C3L |
| 6011 | 2210507671 | E452P3N50011C3M |
| 6012 | 2210507672 | E452P3N50011C41 |
| 6013 | 2210507673 | E452P3N50011C42 |
| 6014 | 2210507674 | E452P3N50011C43 |
| 6015 | 2210507675 | E452P3N50011C45 |
| 6016 | 2210507676 | E452P3N50011C4A |
| 6017 | 2210507677 | E452P3N50011C4B |
| 6018 | 2210507678 | E452P3N50011C4C |
| 6019 | 2210507679 | E452P3N50011C4D |
| 6020 | 2210507680 | E452P3N50011C4E |
| 6021 | 2210507681 | E452P3N50011C4G |
| 6022 | 2210507682 | E452P3N50011C4K |
| 6023 | 2210507683 | E452P3N50011C4L |
| 6024 | 2210507688 | E452P3N50011E05 |
| 6025 | 2210507703 | E452P3N50011R05 |
| 6026 | 2210507714 | E452P3N50011R21 |
| 6027 | 2210507715 | E452P3N50011R22 |
| 6028 | 2210507716 | E452P3N50011R23 |
| 6029 | 2210507717 | E452P3N50011R24 |
| 6030 | 2210507718 | E452P3N50011R25 |
| 6031 | 2210507719 | E452P3N50011R2A |
| 6032 | 2210507720 | E452P3N50011R2B |
| 6033 | 2210507721 | E452P3N50011R2C |
| 6034 | 2210507722 | E452P3N50011R2D |
| 6035 | 2210507723 | E452P3N50011R2G |
| 6036 | 2210507724 | E452P3N50011R2H |
| 6037 | 2210507725 | E452P3N50011R2K |
| 6038 | 2210507726 | E452P3N50011R2L |
| 6039 | 2210507727 | E452P3N50011R2M |
| 6040 | 2210507728 | E452P3N50011S01 |

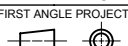
| Pos. | Molex PN: | Engineering No.: |
|------|------------|------------------|
| 6041 | 2210507729 | E452P3N50011S03 |
| 6042 | 2210507730 | E452P3N50011S04 |
| 6043 | 2210507731 | E452P3N50011S05 |
| 6044 | 2210507732 | E452P3N50011S0A |
| 6045 | 2210507733 | E452P3N50011S0C |
| 6046 | 2210507734 | E452P3N50011S0D |
| 6047 | 2210507735 | E452P3N50011S0E |
| 6048 | 2210507736 | E452P3N50011S0G |
| 6049 | 2210507737 | E452P3N50011S0K |
| 6050 | 2210507738 | E452P3N50011S0L |
| 6051 | 2210507739 | E452P3N50011S0M |
| 6052 | 1210502457 | Q452N3N30011C4H |
| 6053 | 1210502462 | Q452P3N30011C4H |
| 6054 | 1210502463 | Q452P3N50011C4H |
| 6055 | 1210502464 | Q452I4N30011C4H |
| 6056 | 1210502465 | Q452I4N50011C4H |
| 6057 | | |
| 6058 | | |
| 6059 | | |
| 6060 | | |
| 6061 | | |
| 6062 | | |
| 6063 | | |
| 6064 | | |
| 6065 | | |
| 6066 | | |
| 6067 | | |
| 6068 | | |
| 6069 | | |
| 6070 | | |
| 6071 | | |
| 6072 | | |
| 6073 | | |
| 6074 | | |
| 6075 | | |
| 6076 | | |
| 6077 | | |
| 6078 | | |
| 6079 | | |
| 6080 | | |

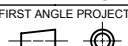
| | | | | | | | | | |
|---|--|-------|--|---|--|-----------------|--|---|--|
| THIS DRAWING CONTAINS INFORMATION THAT IS PROPRIETARY TO MOLEX ELECTRONIC TECHNOLOGIES, LLC AND SHOULD NOT BE USED WITHOUT WRITTEN PERMISSION | | | | | | | | | |
| DIMENSION UNITS | | SCALE | | CURRENT REV DESC: REVISION CREATED FOR REMOVING PRE-RELEASE STAMP | | | |  E452XXXXXXXXXX DIN FORM A EN 175301-803 | |
| mm | | NTS | | | | | | | |
| GENERAL TOLERANCES (UNLESS SPECIFIED) | | | | EC NO: 714567 | | 2022/07/18 | | PRODUCT CUSTOMER DRAWING | |
| | | | | DRWN: SUGEEB | | 2022/07/19 | | | |
| | | | | CHK'D: GGA | | 2022/07/19 | | DOCUMENT NUMBER | |
| | | | | APPR: GGA | | 2022/07/19 | | | |
| | | | | INITIAL REVISION: | | | | SD-121050-001 | |
| | | | | DRWN: JMARSZALEK | | 2012/08/27 | | | |
| | | | | APPR: MDYSZEWSKA | | 2012/08/20 | | DOC TYPE DOC PART REVISION | |
| | | | | ANGULAR TOL | | | | PSD 001 E1 | |
| DRAFT WHERE APPLICABLE MUST REMAIN WITHIN DIMENSIONS | | | | FIRST ANGLE PROJECTION | | DRAWING | | SHEET NUMBER | |
| | | | |  | | A3-SIZE | | 41 OF 41 | |
| | | | | SERIES | | MATERIAL NUMBER | | CUSTOMER | |
| | | | | 121050 | | SEE TABLE | | GENERAL MARKET | |

WIRING CONFIGURATION

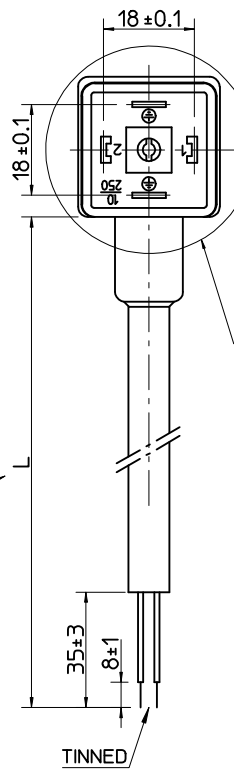

Screw and gasket, see sheet 2, PN Key

See Insert Orientation

Insert Orientation

CIRCUIT PRINTOUT/WHITE

NOTE! IN CASE OF EO, R0, 00 CIRCUITS DIN CONNECTOR IS WITHOUT LED.

| | | |
|---|---------------------------------------|--------------------------------------|
| DOUBLE EARTH ON 6H & 12H E451XXXXXXXX1XXXX | EARTH PIN ON 12H E451XXXXXXXX2XXXX | EARTH PIN ON 6H E451XXXXXXXX6XXXX |
| DOUBLE EARTH ON 3H & 9H E451XXXXXXXX4XXXX | EARTH PIN ON 3H E451XXXXXXXX3XXXX | EARTH PIN ON 9H E451XXXXXXXX9XXXX |

DOUBLE EARTH ON 6H & ON 12H
E451XXXXXXXX1XC3X
E451XXXXXXXX1XC7X
E451XXXXXXXX1XR0X
E451XXXXXXXX1XR2X

NOTE! IN CASE OF CIRCUIT C3,C7,R0,R2 HOUSING INVERSE OF 180°.

| | | |
|---|--|--|
| <p>ELECTRICAL DIAGRAM R0</p> <p>NOT USED</p> | <p>ELECTRICAL DIAGRAM C4</p> <p>NOT USED</p> | <p>ELECTRICAL DIAGRAM S0</p> <p>NOT USED</p> |
| <p>ELECTRICAL DIAGRAM S3</p> <p>NOT USED</p> | <p>ELECTRICAL DIAGRAM A1</p> <p>NOT USED</p> | <p>ELECTRICAL DIAGRAM C3</p> <p>NOT USED</p> |
| <p>ELECTRICAL DIAGRAM E0</p> <p>NOTE: Circuit E0 works from 12V to 230V Only one type in coding E452XXXXXXE05</p> | <p>ELECTRICAL DIAGRAM R2</p> <p>NOT USED</p> | <p>ELECTRICAL DIAGRAM C7</p> <p>NOT USED</p> |

Table of lenght tolerances [mm]

| Over | Up to and including | Tolerance (+) |
|-------|---------------------|---------------|
| 0 | 1000 | ±20 |
| 1000 | 3000 | ±30 |
| 3000 | 5000 | ±40 |
| 5000 | 10000 | ±50 |
| 10000 | 15000 | ±100 |
| 15000 | 20000 | ±150 |
| 20000 | | ±L/100 |

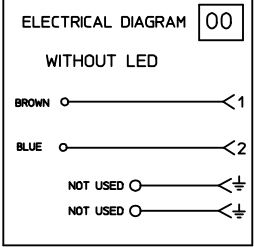

| <p>ORIGINAL RELEASE</p> <p>EC NO: IPG2013-1190</p> <p>DRWN: JMARSZALEK 2012/11/12</p> <p>CHKD: MSZWAJKOWSKI 2012/11/12</p> <p>APPR: MIWASIECZKO 2013/02/12</p> | <p>QUALITY SYMBOLS</p> <p>▽=0</p> <p>◻=0</p> | <p>GENERAL TOLERANCES (UNLESS SPECIFIED)</p> <table border="1"> <thead> <tr> <th></th> <th>mm</th> <th>INCH</th> </tr> </thead> <tbody> <tr><td>4 PLACES</td><td>± ---</td><td>± ---</td></tr> <tr><td>3 PLACES</td><td>± ---</td><td>± ---</td></tr> <tr><td>2 PLACES</td><td>± ---</td><td>± ---</td></tr> <tr><td>1 PLACE</td><td>± ---</td><td>± ---</td></tr> <tr><td>0 PLACE</td><td>± ---</td><td>± ---</td></tr> </tbody> </table> | | | mm | INCH | 4 PLACES | ± --- | ± --- | 3 PLACES | ± --- | ± --- | 2 PLACES | ± --- | ± --- | 1 PLACE | ± --- | ± --- | 0 PLACE | ± --- | ± --- | <p>DIMENSION STYLE</p> <p>MM ONLY</p> | <p>SCALE</p> <p>-</p> | <p>DESIGN UNITS</p> <p>METRIC</p> | <p>FIRST ANGLE PROJECTION</p> |
|--|--|--|---|--|----|------|----------|-------|-------|----------|-------|-------|----------|-------|-------|---------|-------|-------|---------|-------|-------|---------------------------------------|-----------------------|-----------------------------------|-------------------------------|
| | | | mm | INCH | | | | | | | | | | | | | | | | | | | | | |
| | | 4 PLACES | ± --- | ± --- | | | | | | | | | | | | | | | | | | | | | |
| | | 3 PLACES | ± --- | ± --- | | | | | | | | | | | | | | | | | | | | | |
| 2 PLACES | ± --- | ± --- | | | | | | | | | | | | | | | | | | | | | | | |
| 1 PLACE | ± --- | ± --- | | | | | | | | | | | | | | | | | | | | | | | |
| 0 PLACE | ± --- | ± --- | | | | | | | | | | | | | | | | | | | | | | | |
| <p>ANGULAR ± --- °</p> | | <p>DRAWN BY DATE</p> <p>JMARSZALEK 2012/11/12</p> | <p>TITLE</p> <p>E451XXXXXXXXXXXX</p> <p>DIN FORM A</p> <p>EN 175301-803</p> | | | | | | | | | | | | | | | | | | | | | | |
| <p>DRAFT WHERE APPLICABLE MUST REMAIN WITHIN DIMENSIONS</p> | | <p>CHECKED BY DATE</p> <p>MSZWAJKOWSKI 2012/11/12</p> | <p>molex</p> | | | | | | | | | | | | | | | | | | | | | | |
| <p>MATERIAL NO.</p> <p>MATRIX DRAWING</p> | | <p>APPROVED BY DATE</p> <p>MIWASIECZKO 2013/02/12</p> | | <p>DOCUMENT NO.</p> <p>SD-121050-004</p> | | | | | | | | | | | | | | | | | | | | | |
| <p>SIZE</p> <p>A3</p> | | <p>THIS DRAWING CONTAINS INFORMATION THAT IS PROPRIETARY TO MOLEX INCORPORATED AND SHOULD NOT BE USED WITHOUT WRITTEN PERMISSION</p> | | <p>SHEET NO.</p> <p>1 OF 3</p> | | | | | | | | | | | | | | | | | | | | | |

10 9 8 7 6 5 4 3 2 1

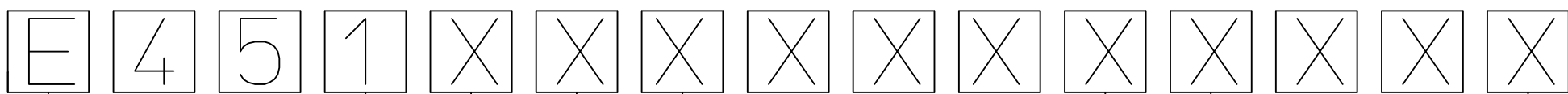

E - Packing without bags
W - Single packing
Q - Quick packing

NUMBER OF WIRES:
1=2 WIRES
2=2 WIRES + EARTH
3=3 WIRES + EARTH

CABLE TYPE
SEE SHEET 3 - TABLE 1

CABLE CROSS SECTION AREA
SEE SHEET 3 - TABLE 2

HEAD COLOUR:
G=GREY;
N=BLACK;
T=TRANSPARENT;
A=CSA-UL BLACK;
B=CSA-UL GREY.

CABLE LENGTH IN CM
Eg.:050=50 CM, 300=300 CM, 10K=1000 CM.

EARTH PIN LOCATION:
1=DOUBLE EARTH ON 6H AND 12H.
2=EARTH ON 12H.
6=EARTH ON 6H.

TYPE OF GASKET AND SCREW:
1=NBR PROFILE GASKET + FIXING SCREWS (M3x25 mm).
2=NBR FLAT GASKET + FIXING SCREW (M3x25 mm).
3=SILICONE PROFILE GASKET + FIXING SCREW (M3x25 mm).
4=SILICON FLAT GASKET + FIXING SCREW (M3x25 mm).
P=INTEGRATED GASKET ASSEMBLED + FIXING SCREW WITH GROMMET ASSEMBLED ON CONNECTOR (M3x27 mm).
R=INTEGRATED GASKET + FIXING SCREW + GROMMET (M3x27 mm).
T=PROFILE GASKET + FIXING SCREW + GROMMET (M3x27 mm).

INTERNAL CIRCUIT
WIRING CONFIGURATION

VOLTAGE AND LED COLOUR:

| | | |
|---------|---------|---------|
| 1= 12V | A= 12V | G= 12V |
| 2= 24V | B= 24V | H= 24V |
| 3= 48V | C= 48V | K= 48V |
| 4= 115V | D= 115V | L= 115V |
| 5= 230V | E= 230V | M= 230V |

RED LED GREEN LED YELLOW LED

| | | | | | | | | | |
|---|-----------------|--|-----------------|------------------|---|-----------------|------------------------|--|--|
| ORIGINAL RELEASE EC NO: IPG2013-1190 DRWN: JMARSZALEK 2012/11/12 CHKD: MSZWAJKOWSKI 2012/11/12 APPR: MIWASIECZKO 2013/02/12 | QUALITY SYMBOLS | GENERAL TOLERANCES (UNLESS SPECIFIED) | DIMENSION STYLE | | SCALE | DESIGN UNITS | FIRST ANGLE PROJECTION | | |
| | ▼=0 ◻=0 | | mm | INCH | - | METRIC | | | |
| | DESCRIPTION | | 4 PLACES | ± --- | ± --- | DRAWN BY DATE | | TITLE E451XXXXXXXXXX DIN FORM A EN 175301-803 molex | |
| | REV | | 3 PLACES | ± --- | ± --- | CHECKED BY DATE | | | |
| | 2 PLACES | ± --- | ± --- | APPROVED BY DATE | | | | | |
| | 1 PLACE | ± --- | ± --- | MATERIAL NO. | | | | | |
| | 0 PLACE | ± --- | ± --- | ANGULAR ± --- ° | | DOCUMENT NO. | SHEET NO. | | |
| | | DRAFT WHERE APPLICABLE MUST REMAIN WITHIN DIMENSIONS | SIZE | | MATRIX DRAWING | | 2 OF 3 | | |
| | | | A3 | | THIS DRAWING CONTAINS INFORMATION THAT IS PROPRIETARY TO MOLEX INCORPORATED AND SHOULD NOT BE USED WITHOUT WRITTEN PERMISSION | | | | |

9 8 7 6 5 4 3 2 1

TABLE 2 - CABLES

| Molex PN | mPm | Code | Wires | Cross Section | Material | Color | Diameter Ø | DIN A-B | DIN C |
|------------|-----|------|-------|---------------|----------------------|--------------|----------------|---------|-------|
| 1210180080 | I | 0 | 3 | 1 mm2 | PVC CEI 2022 II O.R. | Grey RAL7035 | 6,4±0,2 mm | OK. | - |
| 1210180467 | A | 2 | 2 | 20 AWG | PVC CSA/UL 2661 | Black | 5,4±0,2 mm | OK. | OK. |
| 1210180128 | A | 2 | 3 | 20 AWG | PVC CSA/UL 2661 | Black | 5,6±0,2 mm | OK. | OK. |
| 1210180394 | A | 2 | 4 | 20 AWG | PVC CSA/UL 2661 | Black | 6,2±0,25 mm | OK. | OK. |
| - | A | 2 | 5 | 20 AWG | PVC CSA/UL 2661 | Black | 7±0,2 mm | OK. | - |
| 1210180297 | B | 2 | 2 | 20 AWG | PUR CSA/UL 20668 | Black | 5,6±0,2 mm | OK. | OK. |
| 1210180126 | B | 2 | 3 | 20 AWG | PUR CSA/UL 20668 | Black | 5,6±0,2 mm | OK. | OK. |
| 1210180387 | B | 2 | 4 | 20 AWG | PUR CSA/UL 20668 | Black | 6,2±0,2 mm | OK. | OK. |
| - | B | 2 | 5 | 20 AWG | PUR CSA/UL 20668 | Black | 7±0,2 mm | OK. | - |
| 1210180122 | D | 2 | 3 | 0,5 mm2 | PVC TI2 CEI 20-20 | Grey | 5,5±0,2 mm | OK. | OK. |
| - | F | 2 | 3 | 0,5 mm2 | CNOMO | Grey RAL7000 | 5,5±0,2 mm | OK. | OK. |
| 1210180047 | I | 2 | 2 | 0,5 mm2 | PVC CEI 2022 II O.R. | Grey RAL7035 | 5,5±0,3/-0 mm | OK. | OK. |
| 1210180284 | I | 2 | 3 | 0,5 mm2 | PVC CEI 2022 II O.R. | Grey RAL7035 | 5,6±0,3/-0 mm | OK. | OK. |
| 1210180146 | I | 2 | 4 | 0,5 mm2 | PVC CEI 2022 II O.R. | Grey RAL7035 | 6,5±0,2 mm | OK. | OK. |
| 1210180177 | I | 2 | 5 | 0,5 mm2 | PVC CEI 2022 II O.R. | Grey RAL7035 | 7±0,2 mm | OK. | - |
| 1210180022 | N | 2 | 2 | 0,5 mm2 | PVCH03 | Black | 5,2±0,2 mm | OK. | OK. |
| 1202092753 | N | 2 | 3 | 0,5 mm2 | PVCH03 | Black | 5,5±0,2 mm | OK. | OK. |
| 1210180153 | N | 2 | 4 | 0,5 mm2 | PVCH03 | Black | 6,9 mm max | OK. | OK. |
| 1210180046 | P | 2 | 2 | 0,5 mm2 | PUR - BLEND | Black | 5,5±0,2 mm | OK. | OK. |
| 1202092439 | P | 2 | 3 | 0,5 mm2 | PUR - BLEND | Black | 5,5 +0,3/-0 mm | OK. | OK. |
| 1210180302 | P | 2 | 4 | 0,5 mm2 | PUR - BLEND | Black | 6,5±0,2 mm | OK. | OK. |
| 1202092215 | P | 2 | 5 | 0,5 mm2 | PUR - BLEND | Black | 7+0,3/-0,1 mm | OK. | OK. |
| 1210180409 | A | 3 | 2 | 18 AWG | PVC CSA/UL 2661 | Black | 6,5±0,25 mm | OK. | - |
| 1210180129 | A | 3 | 3 | 18 AWG | PVC CSA/UL 2661 | Black | 6,5±0,25 mm | OK. | - |
| 1210180159 | A | 3 | 4 | 18 AWG | PVC CSA/UL 2661 | Black | 7±0,3 mm | OK. | - |
| 1210180464 | A | 3 | 5 | 18 AWG | PVC CSA/UL 2661 | Black | 7,8±0,25 mm | OK. | - |
| 1210180351 | B | 3 | 2 | 18 AWG | PUR CSA/UL 20668 | Black | 6,8±0,2 mm | OK. | - |
| 1210180127 | B | 3 | 3 | 18 AWG | PUR CSA/UL 20668 | Black | 6,5±0,2 mm | OK. | - |
| 1210180160 | B | 3 | 4 | 18 AWG | PUR CSA/UL 20668 | Black | 7±0,2 mm | OK. | - |
| 1210180463 | B | 3 | 5 | 18 AWG | PUR CSA/UL 20668 | Black | 7,8±0,2 mm | OK. | - |
| 1210180073 | D | 3 | 3 | 0,75 mm2 | PVC TI2 CEI 20-20 | Grey | 6,5±0,2 mm | OK. | OK. |
| 1210180145 | D | 3 | 4 | 0,75 mm2 | PVC TI2 CEI 20-20 | Grey | 7,1±0,2 mm | OK. | - |
| 1202098208 | I | 3 | 2 | 0,75 mm2 | PVC CEI 2022 II O.R. | Grey RAL7001 | 5,5±0,2 mm | OK. | - |
| 1210180120 | I | 3 | 3 | 0,75 mm2 | PVC CEI 2022 II O.R. | Grey RAL7035 | 6±0,2 mm | OK. | - |
| 1210180143 | I | 3 | 4 | 0,75 mm2 | PVC CEI 2022 II O.R. | Grey RAL7035 | 7±0,2 mm | OK. | - |
| 1210180032 | N | 3 | 2 | 0,75 mm2 | PVCH05 | Black | 6,2±0,2 mm | OK. | - |
| 1210180069 | N | 3 | 3 | 0,75 mm2 | PVCH05 | Black | 6,5±0,2 mm | OK. | - |
| 1210180144 | N | 3 | 4 | 0,75 mm2 | PVCH05 | Black | 7,1±0,2 mm | OK. | - |
| 1210180174 | N | 3 | 5 | 0,75 mm2 | PVCH05 | Black | 8,0±0,2-0 mm | OK. | - |
| 1202094190 | P | 3 | 2 | 0,75 mm2 | PUR - BLEND | Black | 6,5±0,2 mm | OK. | - |

TABLE 2 - CABLES

| Molex PN | mPm | Code | Wires | Cross Section | Material | Color | Diameter Ø | DIN A-B | DIN C |
|------------|-----|------|-------|---------------|----------------------|--------------|---------------|---------|-------|
| 1210180071 | P | 3 | 3 | 0,75 mm2 | PUR - BLEND | Black | 6,5±0,2 mm | OK. | - |
| 1210180152 | P | 3 | 4 | 0,75 mm2 | PUR - BLEND | Black | 7±0,2 mm | OK. | - |
| 1210180384 | R | 3 | 3 | 0,75 mm2 | TPR HAL. FREE | Black | 6,5±0,2 mm | OK. | - |
| 1210180094 | T | 3 | 3 | 0,75 mm2 | PUR CSA/UL | Yellow | 6,5±0,2 mm | OK. | - |
| 1210180309 | Y | 3 | 3 | 0,75 mm2 | SIL/0300 | Red | 6,5±0,2 mm | OK. | - |
| 1210180081 | F | 4 | 3 | 1 mm2 | CNOMO | Grey RAL7000 | 7,1+0,2/-0 mm | OK. | - |
| - | F | 4 | 4 | 1 mm2 | CNOMO | Grey RAL7000 | 7,1+0,2/-0 mm | OK. | - |
| 1210180042 | I | 4 | 2 | 1 mm2 | PVC CEI 2022 II O.R. | Grey RAL7035 | 7,1+0,2/-0 mm | OK. | - |
| 1210180079 | I | 4 | 3 | 1 mm2 | PVC CEI 2022 II O.R. | Grey RAL7035 | 7,1+0,2/-0 mm | OK. | - |
| 1210180036 | N | 4 | 2 | 1 mm2 | PVCH05 | Black | 6,5±0,2 mm | OK. | - |
| 1210180082 | N | 4 | 3 | 1 mm2 | PVCH05 | Black | 6,9±0,2 mm | OK. | - |
| 1210180117 | R | 4 | 3 | 1 mm2 | TPR HAL. FREE | Black | 7,1±0,2 mm | OK. | - |
| 1210180085 | N | 5 | 3 | 1,5 mm2 | PVCH05 | Black | 8,3+0,2/-0 mm | OK. | - |
| 1210180313 | I | 6 | 2 | 0,35 mm2 | PVC CEI 2022 II O.R. | Grey RAL7035 | 4,8±0,2 mm | OK. | - |
| - | A | 7 | 3 | 20 AWG | PVC CSA/UL 2661 | Yellow | 5,6±0,2 mm | OK. | OK. |
| 1210180149 | I | 9 | 4 | 0,75 mm2 | PVC CEI 2022 II O.R. | Grey RAL7035 | 7,3±0,2 mm | OK. | - |

TABLE 1 - CABLES TYPE

| Code | Cable types | Features | Stranding |
|------|-------------|---|--|
| N | PVC | Application general purpose cable which has good resistance to water, but usually poor oil resistance. | 0,5 mm2 = 15 x 0,20 0,75 mm2 = 21 x 0,20 1 mm2 = 28 x 0,20 |
| I | CEI | Approved to IEC 332-2A, flame retardant and self extinguishing. Limited resistant to mineral oils. | 0,5 mm2 = 28 x 0,15 0,75 mm2 = 42 x 0,15 1 mm2 = 32 x 0,20 |
| P | PUR | Offer good resistance to oil and chemicals. Can swell when constantly immersed in water. | 0,5 mm2 = 28 x 0,15 0,75 mm2 = 42 x 0,15 1 mm2 = 32 x 0,20 |
| A | PVC CSA-UL | Approved to CSA-UL 2661, application general purpose cable which has good resistance to water, but usually poor oil resistance. | 20 AWG = 32 x 0,15 18 AWG = 52 x 0,15 |
| B | PUR CSA-UL | Approved to CSA-UL 20668, very good resistance to oil and chemicals. | 20 AWG = 32 x 0,15 18 AWG = 52 x 0,15 |

| | | | | | | | | | |
|---|-------------------------------|---------------------------------------|---|----------------------------|----------------------------|--------------------|---|------------------------|--|
| ORIGINAL RELEASE EC NO: IPG2013-1190 DRWN: JMARSZALEK 2012/11/12 CHKD: MSZWAJKOWSKI 2012/11/12 APPR: MIWASIECZKO 2013/02/12 | QUALITY SYMBOLS ▽=0 ◻=0 | GENERAL TOLERANCES (UNLESS SPECIFIED) | | DIMENSION STYLE MM ONLY | | SCALE - | DESIGN UNITS METRIC | FIRST ANGLE PROJECTION | |
| | | | mm | INCH | DRAWN BY JMARSZALEK | DATE 2012/11/12 | TITLE E451XXXXXXXXXX DIN FORM A EN 175301-803 | | |
| | | 4 PLACES | ± --- | ± --- | CHECKED BY MSZWAJKOWSKI | DATE 2012/11/12 |  | | |
| | | 3 PLACES | ± --- | ± --- | APPROVED BY MIWASIECZKO | DATE 2013/02/12 | | | |
| 2 PLACES | ± --- | ± --- | ANGULAR ±---° | | MATERIAL NO. | DOCUMENT NO. | SHEET NO. | | |
| 1 PLACE | ± --- | ± --- | DRAFT WHERE APPLICABLE MUST REMAIN WITHIN DIMENSIONS | | SIZE A3 | SD-121050-004 | 3 OF 3 | | |
| 0 PLACE | ± --- | ± --- | THIS DRAWING CONTAINS INFORMATION THAT IS PROPRIETARY TO MOLEX INCORPORATED AND SHOULD NOT BE USED WITHOUT WRITTEN PERMISSION | | | | | | |