

FAN1616A

0.5A Adjustable/Fixed Low Dropout Linear Regulator

Features

- Low dropout voltage
- Load regulation: 0.05% typical
- Current limit
- On-chip thermal limiting
- Standard SOT-223 and TO-252 packages
- Three-terminal adjustable or fixed 1.8V, 2.5V, 3.3V or 5V
- Specified from -40°C to +125°C

Applications

- USB Controlled Power Supply
- High efficiency linear regulators for Mixed Voltage Logic, ASIC, FPGA based systems
- Post regulators for switching supplies
- Battery chargers
- 12V to 5V, 3.3V, 2.5V, 1.8V, or adj linear regulators
- Motherboard clock supplies
- SDRAM Module supplies

Description

The FAN1616A, FAN1616A-1.8, -2.5, -3.3 and -5 are low dropout three-terminal regulators with 0.5A output current capability. These devices have been optimized for applications where transient response and minimum dropout voltage are critical. The 5V version is designed also to be used in USB Hub and Motherboard applications.

On-chip thermal limiting provides protection against any combination of overload and ambient temperature that would create excessive junction temperatures.

Unlike PNP type regulators where up to 10% of the output current is wasted as quiescent current, the bias current of the FAN1616A flows into the load, increasing efficiency.

The FAN1616A series regulators are available in the industry-standard SOT-223 and TO-252 power packages.

Typical Applications

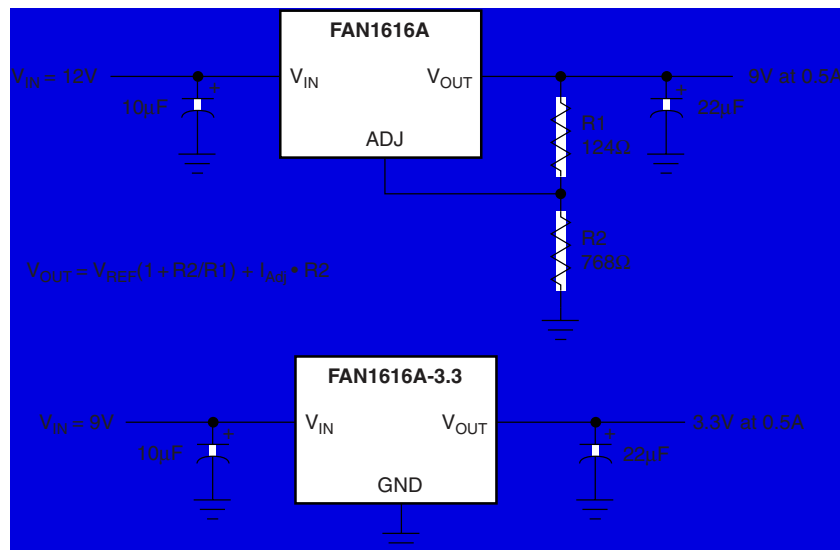

Pin Assignments

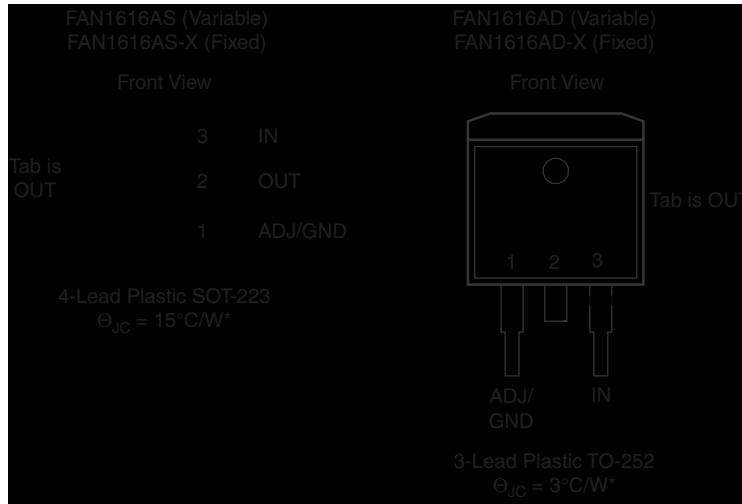

*With package soldered to 0.5 square inch copper area over backside ground plane or internal power plane, θ_{JA} can vary from 30°C/W to $>50^{\circ}\text{C/W}$. Other mounting techniques may provide better power dissipation than 30°C/W .

Absolute Maximum Ratings

Parameter	Min.	Max.	Unit
V_{IN}		18	V
$(V_{IN}-V_{OUT}) * I_{OUT}$		See Figure 1	
Operating Junction Temperature Range	-40	125	$^{\circ}\text{C}$
Storage Temperature Range	-65	150	$^{\circ}\text{C}$
Lead Temperature (Soldering, 10 sec.)		300	$^{\circ}\text{C}$

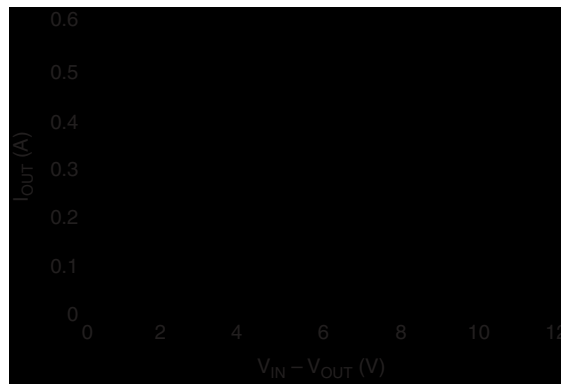

Figure 1. Absolute Maximum Safe Operating Area

Electrical Characteristics

Operating Conditions: $V_{IN} \leq 12V$, $T_J = 25^\circ C$ unless otherwise specified.

The • denotes specifications which apply over the specified operating temperature range.

Parameter	Conditions	Min.	Typ.	Max.	Units
Reference Voltage ³	$1.5V \leq (V_{IN} - V_{OUT}) \leq 5.75V$, $10mA \leq I_{OUT} \leq 0.5A$	• 1.225 (-2%)	1.250	1.275 (+2%)	V
Output Voltage ⁴	$10mA \leq I_{OUT} \leq 0.5A$ FAN1616A-1.8, $3.3V \leq V_{IN} \leq 12V$ FAN1616A-2.5, $4.0V \leq V_{IN} \leq 12V$ FAN1616A-3.3, $4.5V \leq V_{IN} \leq 12V$ FAN1616A-5, $6.2V \leq V_{IN} \leq 12V$	• 1.764 • 2.450 • 3.234 • 4.900	1.800 2.500 3.300 5.000	1.836 2.550 3.366 5.100	V V V V
Line Regulation ^{1,2}	$(V_{OUT} + 1.5V) \leq V_{IN} \leq 12V$, $I_{OUT} = 10mA$	•	0.005	0.2	%
Load Regulation ^{1,2,3}	$(V_{IN} - V_{OUT}) = 2V$, $10mA \leq I_{OUT} \leq 0.5A$	•	0.05	0.5	%
Dropout Voltage	$\Delta V_{REF} = 1\%$, $I_{OUT} = 0.5A$	•	1.000	1.200	V
Adjust Pin Current ³		•	35	120	μA
Adjust Pin Current Change ^{3,4}	$1.5V \leq (V_{IN} - V_{OUT}) \leq 12V$, $10mA \leq I_{OUT} \leq 0.5A$	•	0.2	5	μA
Minimum Load Current	$1.5V \leq (V_{IN} - V_{OUT}) \leq 12V$	•	10		mA
Quiescent Current	$V_{IN} = V_{OUT} + 1.25V$	•	4	13	mA
Ripple Rejection	$f = 120Hz$, $C_{OUT} = 22\mu F$ Tantalum, $(V_{IN} - V_{OUT}) = 3V$, $I_{OUT} = 0.5A$		60	72	dB
Thermal Regulation	$T_A = 25^\circ C$, 30ms pulse		0.004	0.02	%/W
Temperature Stability		•	0.5		%
Long-Term Stability	$T_A = 125^\circ C$, 1000hrs.		0.03	1.0	%
RMS Output Noise (% of V_{OUT})	$T_A = 25^\circ C$, $10Hz \leq f \leq 10kHz$		0.003		%
Thermal Resistance, Junction to Case	SOT-223		15		$^\circ C/W$
	TO-252		3		$^\circ C/W$
Thermal Shutdown			150		$^\circ C$

Notes:

- See thermal regulation specifications for changes in output voltage due to heating effects. Load and line regulation are measured at a constant junction temperature by low duty cycle pulse testing.
- Line and load regulation are guaranteed up to the maximum power dissipation. Power dissipation is determined by input/output differential and the output current. Guaranteed maximum output power will not be available over the full input/output voltage range.
- FAN1616A only.
- Output current must be limited to meet the absolute maximum ratings of the part.

Typical Performance Characteristics

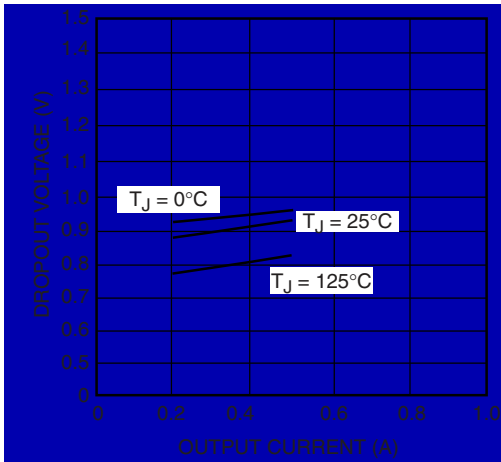

Figure 2. Dropout Voltage vs. Output Current

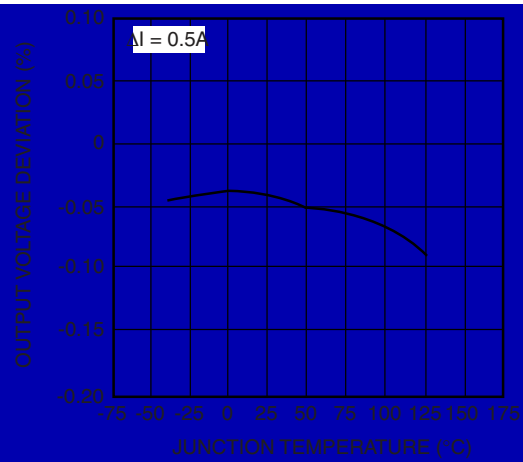

Figure 3. Load Regulation vs. Temperature

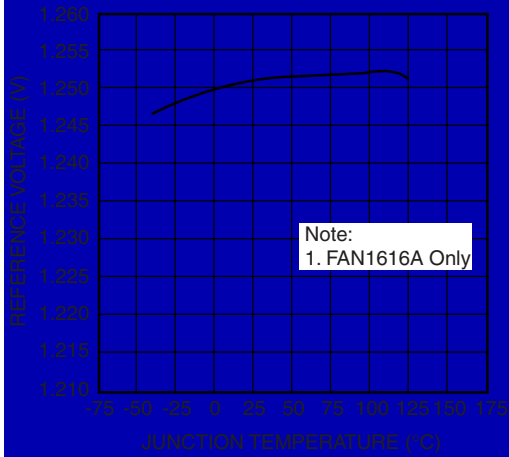

Figure 4. Reference Voltage vs. Temperature

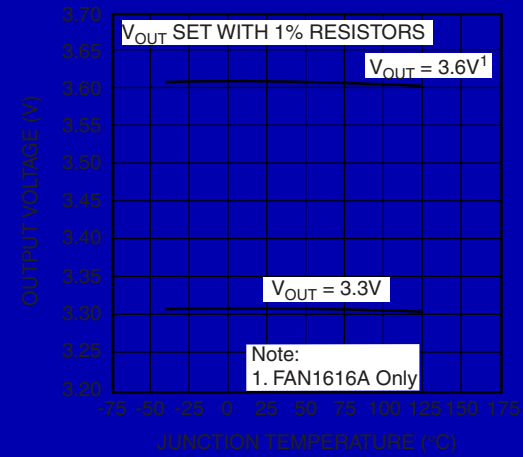

Figure 5. Output Voltage vs. Temperature

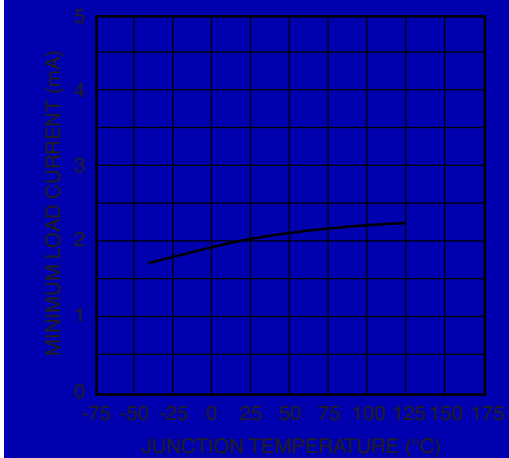

Figure 6. Minimum Load Current vs. Temperature

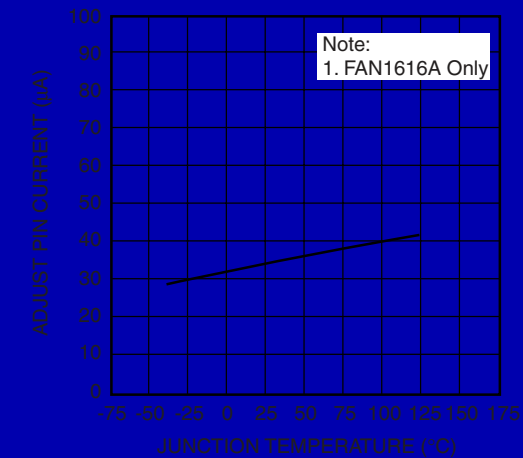

Figure 7. Adjust Pin Current vs. Temperature

Typical Performance Characteristics (continued)

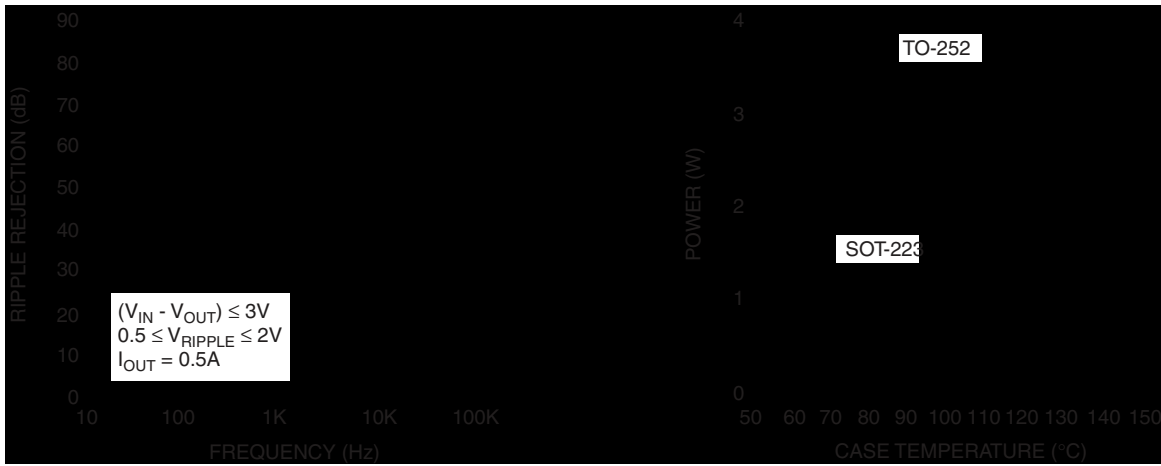
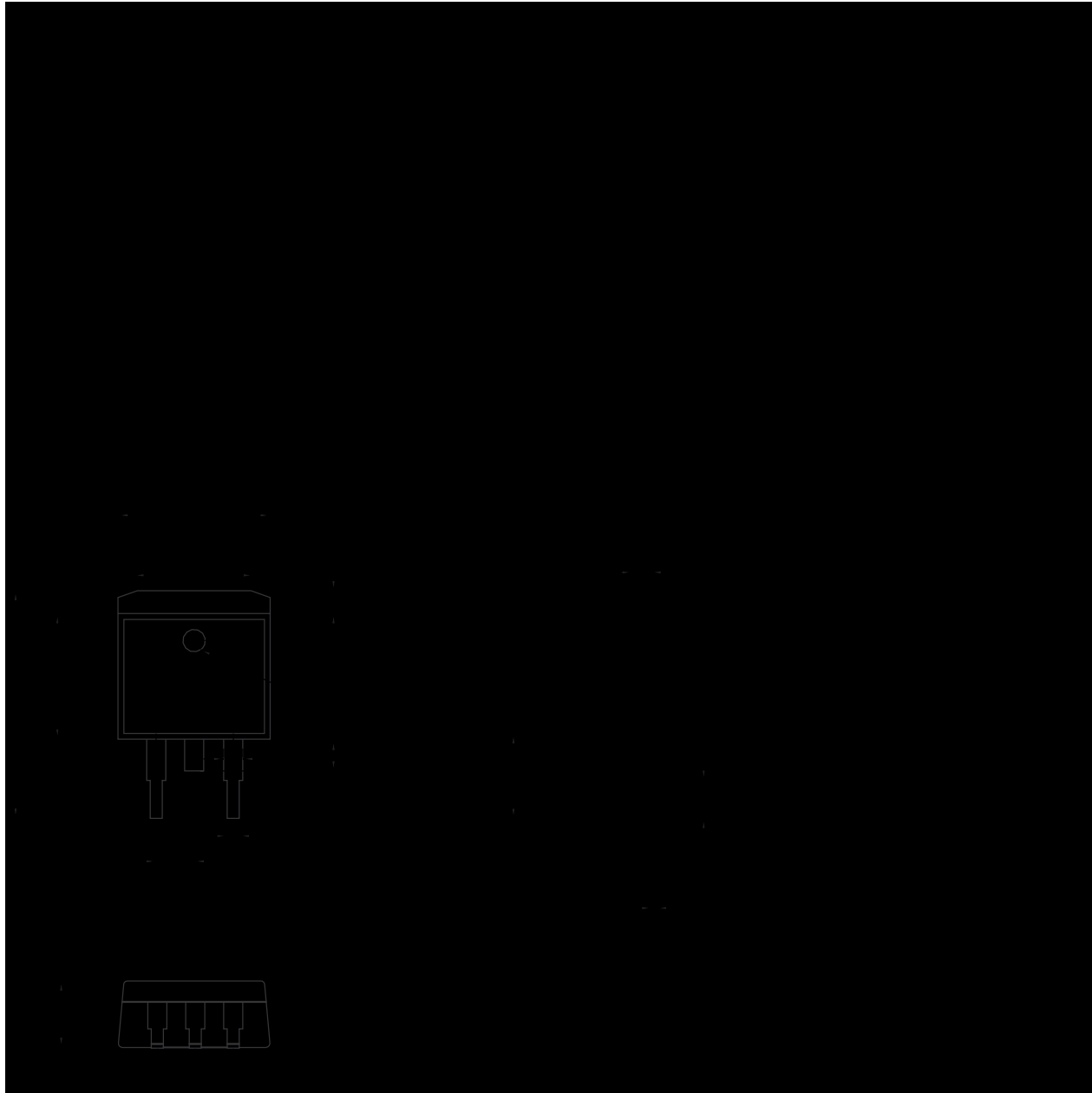

Figure 8. Ripple Rejection vs. Frequency

Figure 9. Maximum Power Dissipation

Mechanical Dimensions

3-Lead TO-252 Package



Mechanical Dimensions

4-Lead SOT-223 Package

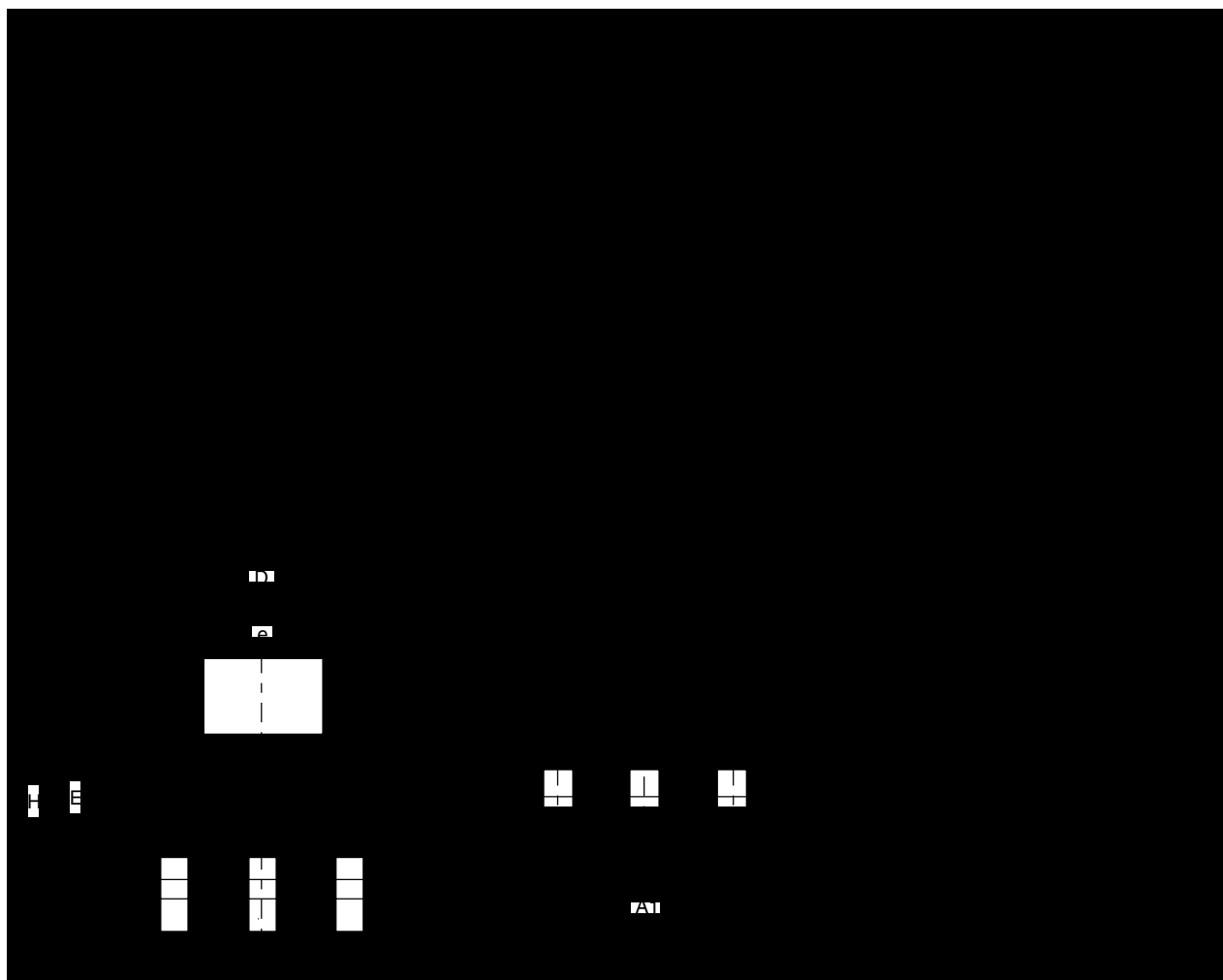

Ordering Information

Product Number	Package
FAN1616ADX	TO-252 in tape and reel
FAN1616ASX	SOT-223 in tape and reel
FAN1616AD18X	TO-252 in tape and reel
FAN1616AS18X	SOT-223 in tape and reel
FAN1616AD25X	TO-252 in tape and reel
FAN1616AS25X	SOT-223 in tape and reel
FAN1616AD33X	TO-252 in tape and reel
FAN1616AS33X	SOT-223 in tape and reel
FAN1616AD5X	TO-252 in tape and reel
FAN1616AS5X	SOT-223 in tape and reel

DISCLAIMER

FAIRCHILD SEMICONDUCTOR RESERVES THE RIGHT TO MAKE CHANGES WITHOUT FURTHER NOTICE TO ANY PRODUCTS HEREIN TO IMPROVE RELIABILITY, FUNCTION OR DESIGN. FAIRCHILD DOES NOT ASSUME ANY LIABILITY ARISING OUT OF THE APPLICATION OR USE OF ANY PRODUCT OR CIRCUIT DESCRIBED HEREIN; NEITHER DOES IT CONVEY ANY LICENSE UNDER ITS PATENT RIGHTS, NOR THE RIGHTS OF OTHERS.

LIFE SUPPORT POLICY

FAIRCHILD'S PRODUCTS ARE NOT AUTHORIZED FOR USE AS CRITICAL COMPONENTS IN LIFE SUPPORT DEVICES OR SYSTEMS WITHOUT THE EXPRESS WRITTEN APPROVAL OF THE PRESIDENT OF FAIRCHILD SEMICONDUCTOR CORPORATION. As used herein:

1. Life support devices or systems are devices or systems which, (a) are intended for surgical implant into the body, or (b) support or sustain life, and (c) whose failure to perform when properly used in accordance with instructions for use provided in the labeling, can be reasonably expected to result in a significant injury of the user.
2. A critical component in any component of a life support device or system whose failure to perform can be reasonably expected to cause the failure of the life support device or system, or to affect its safety or effectiveness.