

ALMD-LM38/ALMD-LB38

High Brightness SMT Oval Green and Blue LED Lamps

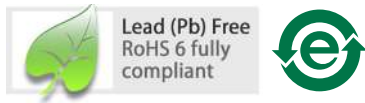

Data Sheet



Description

The new Avago ALMD-Lx38 Oval LED series has the same or just slightly less luminous intensity than conventional high brightness through holes LEDs.

The new Oval LED lamps can be assembled using common SMT assembly processes and are compatible with industrial reflow soldering processes.

The LEDs are made with an advanced optical grade epoxy for superior performance in outdoor sign applications. The surface mount Oval LEDs are specifically designed for full color / video signs and indoor or outdoor passenger information sign applications.

For easy pick and place assembly, the LEDs are shipped in tape and reel. Every reeled is shipped from a single intensity and color bin for better uniformity.

Package Dimensions

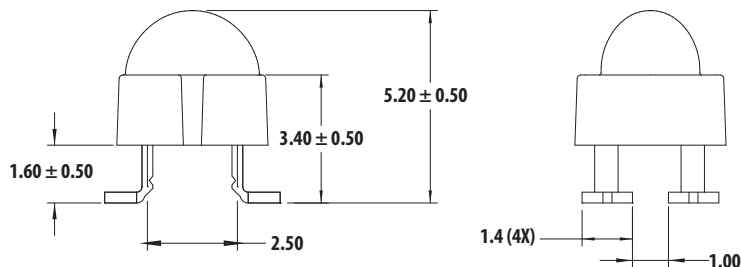
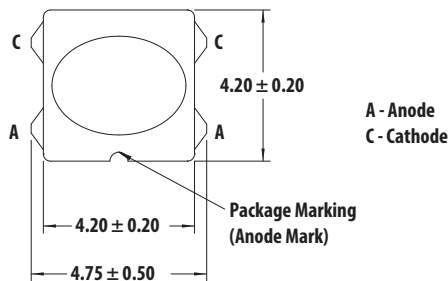

- Notes:
1. All dimensions in millimeters (inches).
 2. Tolerance is ± 0.20 mm unless other specified.
 3. Mildsteel leadframe.

Features

- Well defined spatial radiation pattern
- High brightness material
- Available in Green and Blue LED
 - Green InGaN 525nm
 - Blue InGaN 470nm
- Jedec MSL 2A
- Compatible with reflow soldering process
- Tinted and diffused lens
- Wide viewing angle: $40^\circ \times 100^\circ$

Applications

- Mono color signs

CAUTION: InGaN devices are Class 1C HBM ESD sensitive, AlInGaP devices are Class 1B ESD sensitive per JEDEC Standard. Please observe appropriate precautions during handling and processing. Refer to Application Note AN-1142 for additional details.

CAUTION: Customer is advised to always keep the LED in the moisture barrier bag with $<5\%RH$ when not in use as prolonged exposure to environment might cause the leads to tarnish or rust, which might cause difficulties in soldering.

Device Selection Guide

Part Number	Color and Dominant Wavelength λ_d (nm) Typ [3]	Luminous Intensity Iv (mcd) [1,2,5]		Viewing Angle Typ - ° [4]
		Min	Max	
ALMD-LM38-24002	Green 525	3500	6050	40° x 100°
ALMD-LB38-TV002	Blue 470	800	1380	40° x 100°

Notes:

1. The luminous intensity is measured on the mechanical axis of the lamp package and it is tested with pulsing condition.
2. The optical axis is closely aligned with the package mechanical axis.
3. Dominant wavelength, λ_d , is derived from the CIE Chromaticity Diagram and represents the color of the lamp.
4. $\theta_{1/2}$ is the off-axis angle where the luminous intensity is half the on-axis intensity.
5. Tolerance for each bin limit is $\pm 15\%$

Part Numbering System

A L M D -

x1	x2	x3	x4
----	----	----	----

 -

x5	x6	x7	x8	x9
----	----	----	----	----

Code	Description	Option
x1	Package type	L Oval AlInGaP/InGaN
x2	Color	B Blue M Green
x3x4	Viewing angle	38 40 x 100°
x5	Minimum intensity bin	Refer to device selection guide
x6	Maximum intensity bin	Refer to device selection guide
x7	Color bin selection	0 Full distribution
x8x9	Packaging option	02 Tested 20mA, 13inch carrier tape

Absolute Maximum Rating, $T_J = 25\text{ }^\circ\text{C}$

Parameter	Green	Blue	Unit
DC Forward Current ^[1]	30	20	mA
Peak Forward Current	100 ^[2]	100 ^[2]	mA
Power Dissipation	114	70	mW
LED Junction Temperature	110	105	$^\circ\text{C}$
Operating Temperature Range	-40 to +85		$^\circ\text{C}$
Storage Temperature Range	-40 to +100		$^\circ\text{C}$

Notes:

1. Derate linearly as shown in Figure 4.
2. Duty Factor 10%, frequency 1kHz.

Electrical / Optical Characteristics, $T_J = 25\text{ }^\circ\text{C}$

Parameter	Symbol	Min.	Typ.	Max.	Units	Test Conditions
Forward Voltage	V_F				V	$I_F = 20\text{ mA}$
Green		2.8	3.2	3.8		
Blue		2.8	3.2	3.5		
Reverse Voltage ^[3]	V_R				V	$I_R = 10\text{ }\mu\text{A}$
Green & Blue		5				
Dominant Wavelength ^[1]	λ_d				nm	$I_F = 20\text{ mA}$
Green		519	525	539		
Blue		460	470	480		
Peak Wavelength	λ_{PEAK}				nm	Peak of Wavelength of Spectral Distribution at $I_F = 20\text{ mA}$
Green			522			
Blue			464			
Thermal Resistance	$R\theta_{J-PIN}$				$^\circ\text{C}/\text{W}$	LED Junction-to-Pin
Green			270			
Blue			480			
Luminous Efficacy ^[2]	η_V				lm/W	Emitted Luminous Power/Emitted Radiant Power
Green			500			
Blue			85			
Thermal coefficient of λ_d					nm/ $^\circ\text{C}$	$I_F = 20\text{ mA}$; $+25^\circ\text{C} \leq T_J \leq +100^\circ\text{C}$
Green			0.033			
Blue			0.033			

Notes:

1. The dominant wavelength is derived from the chromaticity Diagram and represents the color of the lamp.
2. The radiant intensity, I_e in watts per steradian, may be found from the equation $I_e = I_V/\eta_V$ where I_V is the luminous intensity in candelas and η_V is the luminous efficacy in lumens/watt.
3. Indicates product final testing condition. Long term reverse bias is not recommended.

InGaN

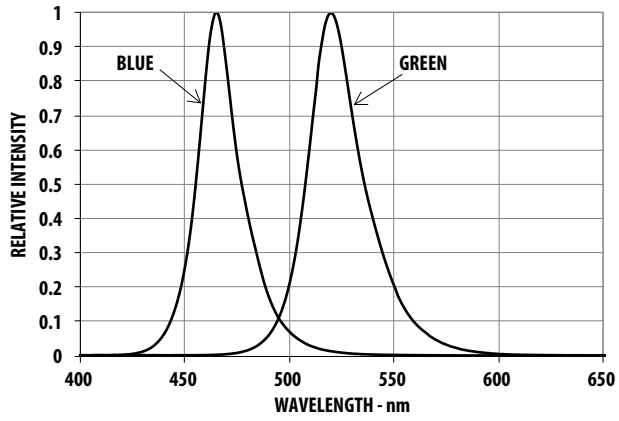

Figure 1. Relative Intensity vs Wavelength

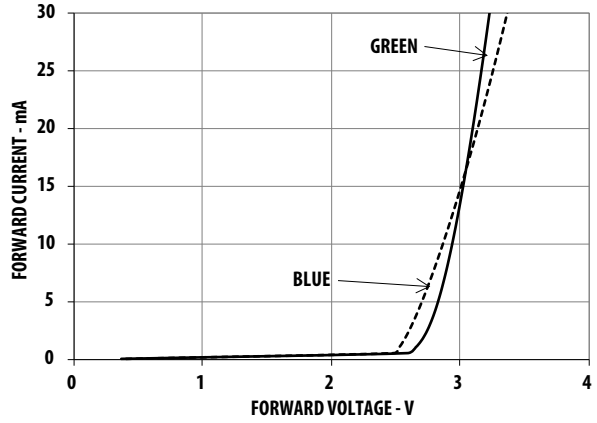

Figure 2. Forward Current vs Forward Voltage

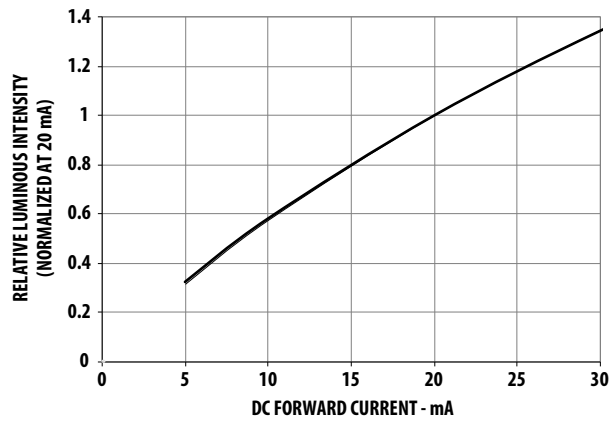

Figure 3. Relative Intensity vs Forward Current

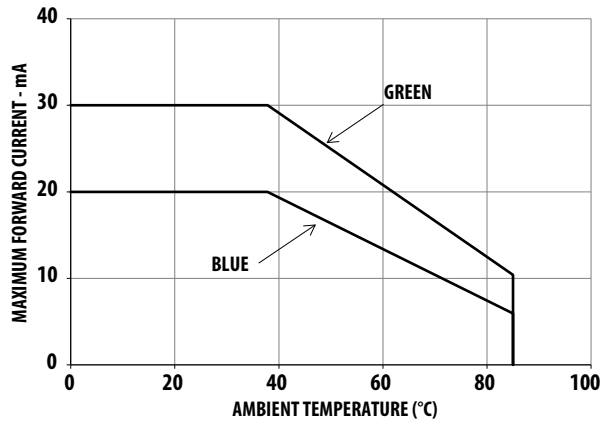

Figure 4. Maximum Forward Current vs Ambient Temperature

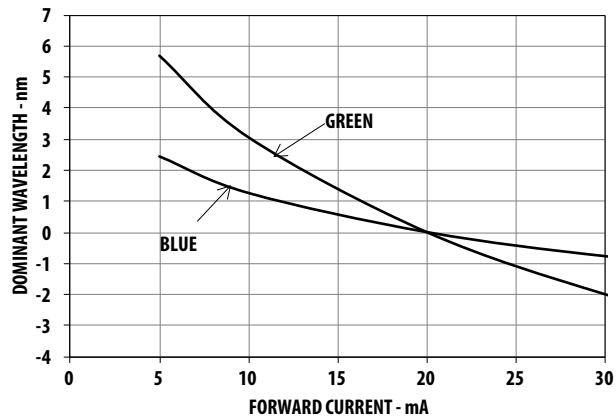

Figure 5. Dominant Wavelength Shift vs Forward Current

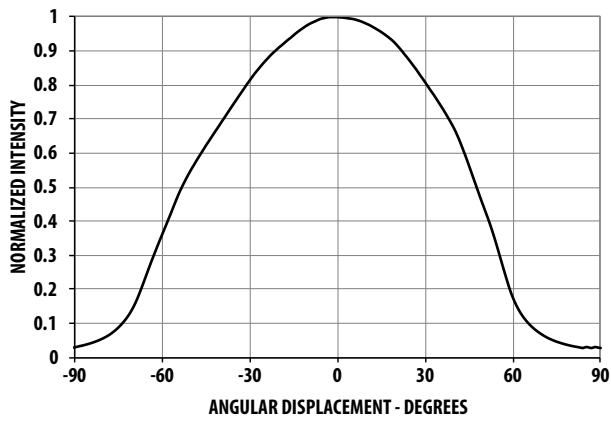

Figure 6a. Radiation Pattern for Major Axis

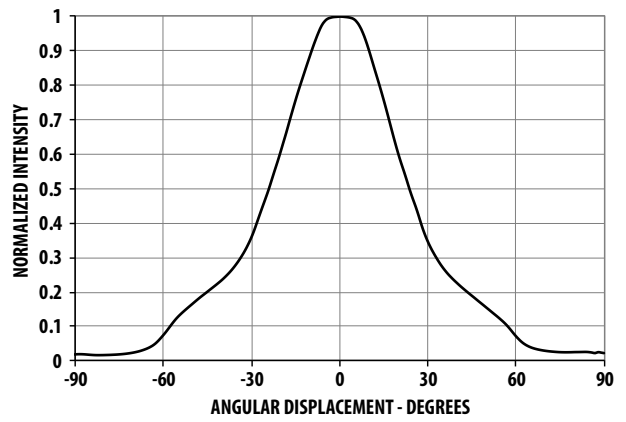

Figure 6b. Radiation Pattern for Minor Axis

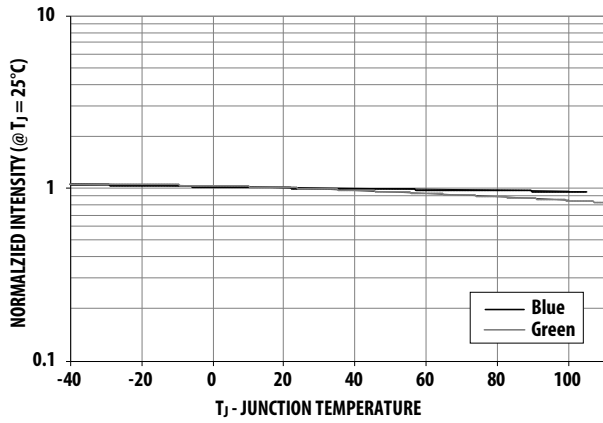

Figure 7. Relative Intensity Shift vs Junction Temperature

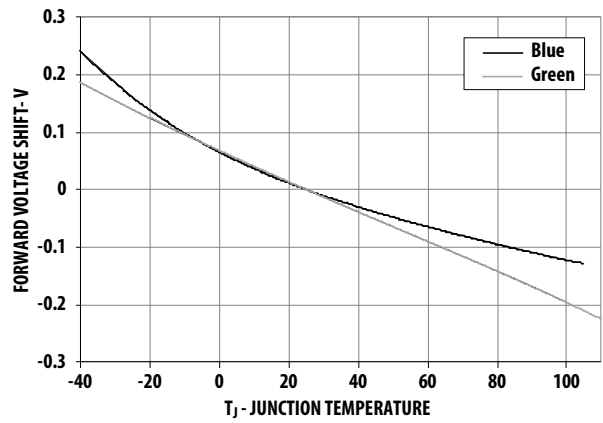
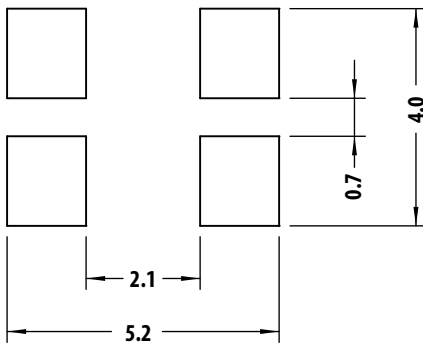

Figure 8. Forward Voltage Shift vs Junction Temperature



Note: Recommended stencil thickness is 0.1524mm (6 mils) minimum and above

Figure 9. Recommended Soldering Land Pattern

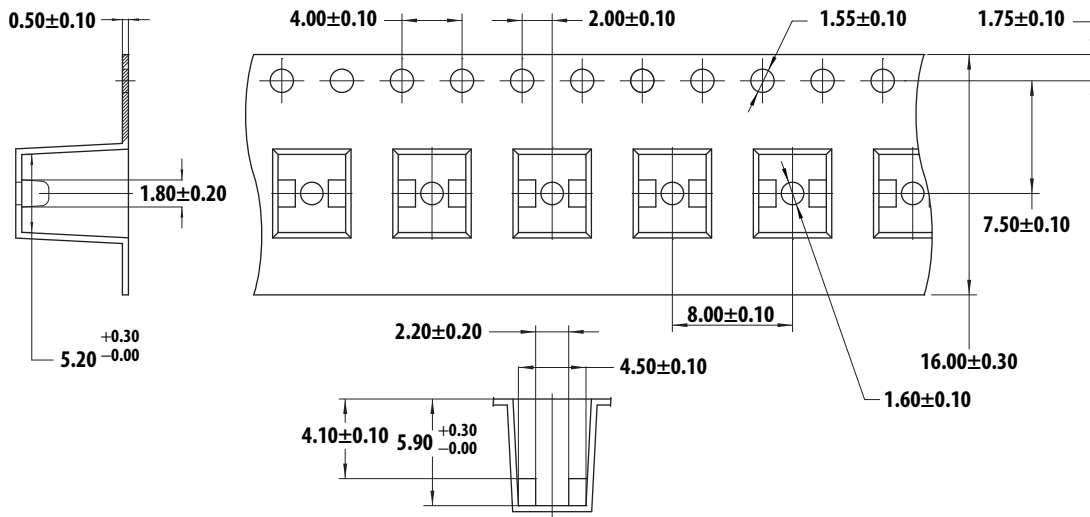

Figure 10. Carrier Tape Dimension

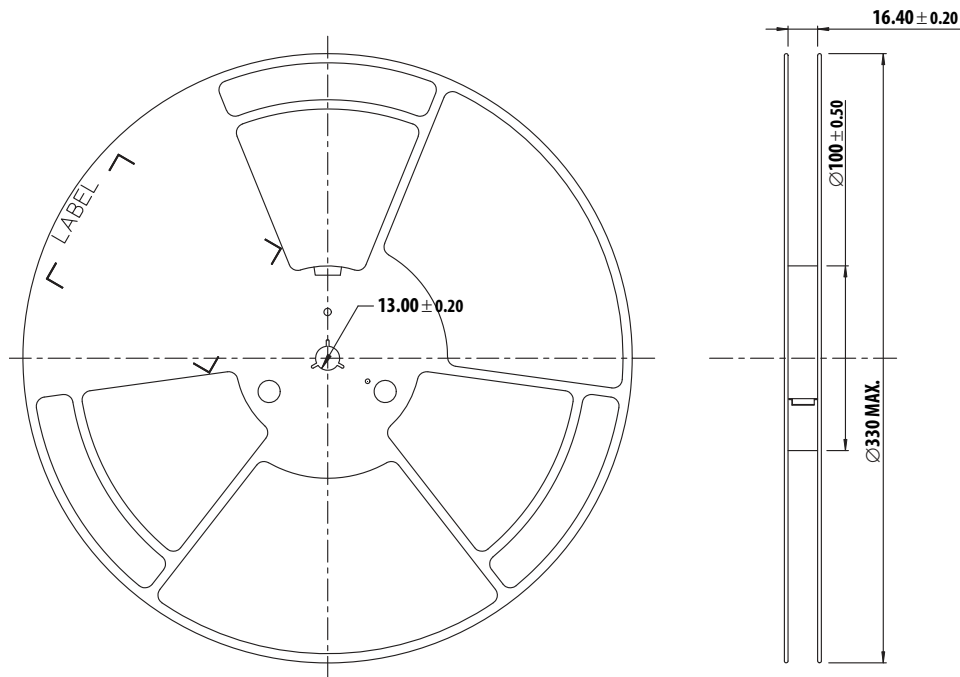

Figure 11. Reel Dimension

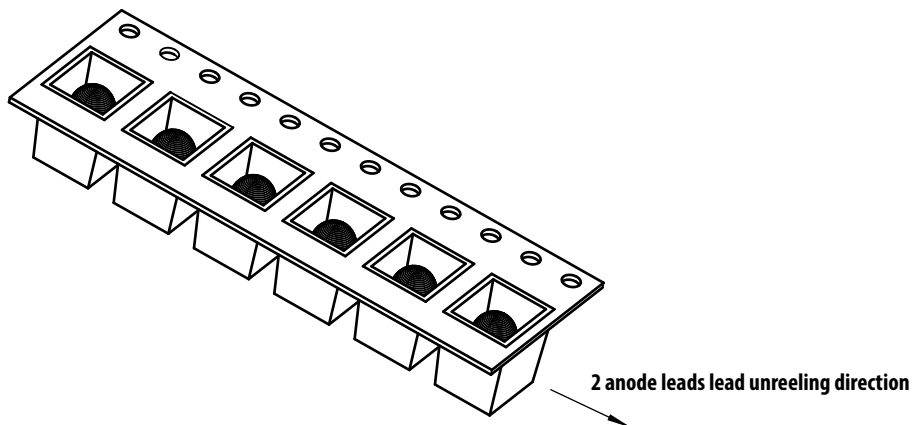

Figure 12. Unit Orientation from reel

Intensity Bin Limit Table (1.2:1 lv bin ratio)

Bin	Intensity (mcd) at 20 mA	
	Min	Max
T	800	960
U	960	1150
V	1150	1380
W	1380	1660
X	1660	1990
Y	1990	2400
Z	2400	2900
1	2900	3500
2	3500	4200
3	4200	5040
4	5040	6050

Tolerance for each bin limit is $\pm 15\%$

Green Color Range

Bin	Min Dom	Max Dom	Xmin	Ymin	Xmax	Ymax
1	519.0	523.0	0.0667	0.8323	0.1450	0.7319
			0.1200	0.7375	0.0979	0.8316
2	523.0	527.0	0.0979	0.8316	0.1711	0.7218
			0.1450	0.7319	0.1305	0.8189
3	527.0	531.0	0.1305	0.8189	0.1967	0.7077
			0.1711	0.7218	0.1625	0.8012
4	531.0	535.0	0.1625	0.8012	0.2210	0.6920
			0.1967	0.7077	0.1929	0.7816
5	535.0	539.0	0.1929	0.7816	0.2445	0.6747
			0.2210	0.6920	0.2233	0.7600

Tolerance for each bin limit is ± 0.5 nm













Blue Color Range

Bin	Min Dom	Max Dom	Xmin	Ymin	Xmax	Ymax
1	460.0	464.0	0.1440	0.0297	0.1766	0.0966
			0.1818	0.0904	0.1374	0.0374
2	464.0	468.0	0.1374	0.0374	0.1699	0.1062
			0.1766	0.0966	0.1291	0.0495
3	468.0	472.0	0.1291	0.0495	0.1616	0.1209
			0.1699	0.1062	0.1187	0.0671
4	472.0	476.0	0.1187	0.0671	0.1517	0.1423
			0.1616	0.1209	0.1063	0.0945
5	476.0	480.0	0.1063	0.0945	0.1397	0.1728
			0.1517	0.1423	0.0913	0.1327









Tolerance for each bin limit is ± 0.5 nm

Packing Label

(i) Mother Label (Available on MBB bag)

<p>(1P) Item: Part Number  (1T) Lot: Lot Number  LPN:  (9D)MFG Date: Manufacturing Date </p>		<p>AvAGO TECHNOLOGIES STANDARD LABEL LS0002 RoHS Compliant (Q) QTY: Quantity e4 Max Temp 260C MSL 2a  CAT: Intensity Bin  BIN: Refer to below information </p>	
<p>(P) Customer Item: </p>			
<p>(V) Vendor ID: </p>		<p>(9D) Date Code: Date Code </p>	
<p>DeptID: OEAT01 </p>		<p>Made In: Country of Origin </p>	

(ii) Baby Label (Available on Plastic Reel)

<p>(1P) PART #: Part Number  (1T) Lot #: Lot Number  (9D)MFG Date: Manufacturing Date  C/O: Country of Origin  (1T) TAPE DATE: Taping Date </p>		<p>AvAGO TECHNOLOGIES BABY LABEL COSBO01B V0.0 (Q) QTY: Quantity  (9D) Date Code: Date Code  CAT Intensity Bin  BIN Refer to Below information</p>	
--	--	---	--

Note: Acronyms and Definition:

BIN:

(i) Color bin only or VF bin only

(Applicable for part number with color bins but without VF bin OR part number with VF bins and no color bin)

(ii) Color bin incorporated with VF bin

Applicable for part number that have both color bin and VF bin

Example:

- a. Color bin only or VF bin only
 BIN: 4 (represent color bin 4 only)
 BIN: VA (represent VF bin "VA" only)
- b. Color bin incorporate with VF bin

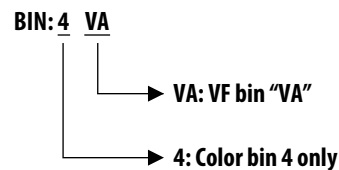

Soldering

Recommended reflow soldering condition:

(i) Leaded reflow soldering:

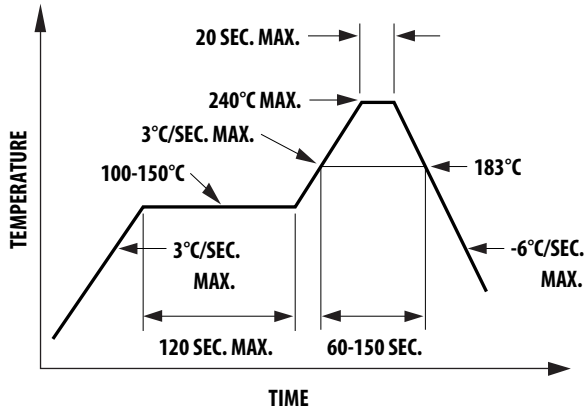

a. Reflow soldering must not be done more than two times. Do observe necessary precautions for handling a moisture-sensitive device, as stated in the following section.

b. Recommended board reflow direction:

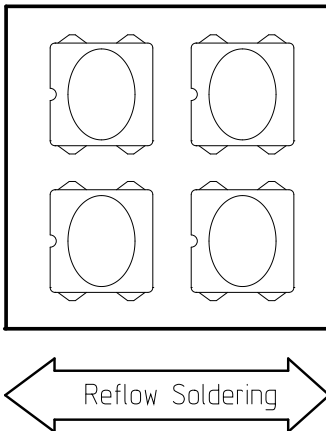

(ii) Lead-free reflow soldering:

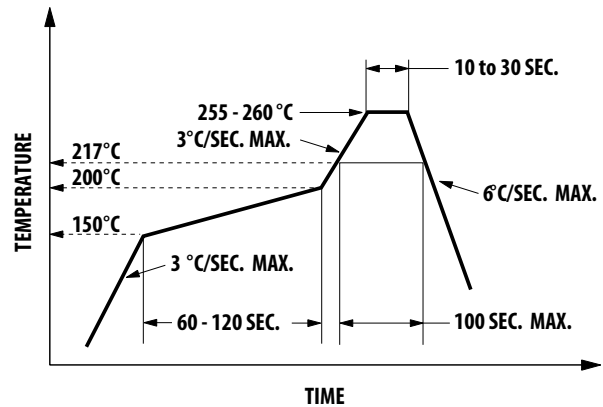

c. Do not apply any pressure or force on the LED during reflow and after reflow when the LED is still hot.

d. It is preferred that you use reflow soldering to solder the LED. Use hand soldering only for rework if unavoidable but must be strictly controlled to the following conditions:

- Soldering iron tip temperature = 320 °C max.
- Soldering duration = 3 sec max.
- Number of cycles = 1 only
- Power of soldering iron = 50 W max.

e. Do not touch the LED body with a hot soldering iron except the soldering terminals as this may damage the LED.

f. For de-soldering, it is recommended to use appropriate double head soldering iron. User is advised to confirm beforehand whether the functionality and performance of the LED is affected by hand soldering.

PRECAUTIONARY NOTES

1. Handling precautions

For automated pick and place, Avago has tested nozzle size below made with urethane material to be working fine with this LED. However, due to the possibility of variations in other parameters such as pick and place machine maker/model and other settings of the machine, customer is recommended to verify the nozzle selected.

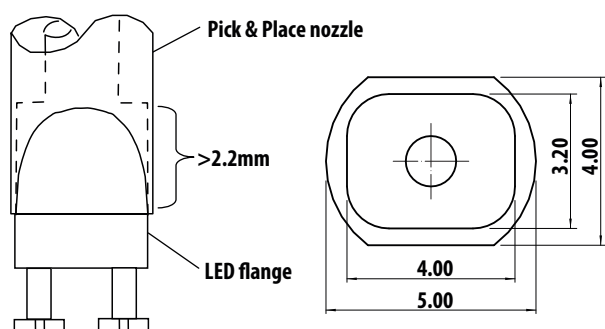

Note:

1. Nozzle tip should touch the LED flange during pick and place.
2. Outer dimensions of the nozzle should be able to fit into the carrier tape pocket.

2. Handling of moisture-sensitive device

This product has a Moisture Sensitive Level 2a rating per JEDEC J-STD-020. Refer to Avago Application Note AN5305, Handling of Moisture Sensitive Surface Mount Devices, for additional details and a review of proper handling procedures.

a. Before use

- An unopened moisture barrier bag (MBB) can be stored at $40^{\circ}\text{C}/90\% \text{RH}$ for 12 months. If the actual shelf life has exceeded 12 months and the humidity Indicator Card (HIC) indicates that baking is not required, then it is safe to reflow the LEDs per the original MSL rating.
- It is recommended that the MBB not be opened prior to assembly (e.g. for IQC).

b. Control after opening the MBB

- The humidity indicator card (HIC) shall be read immediately upon opening of MBB.
- The LEDs must be kept at $30^{\circ}\text{C} / 60\% \text{RH}$ at all times and all high temperature related processes including soldering, curing or rework need to be completed within 672 hours.

c. Control for unfinished reel

- Unused LEDs must be stored in a sealed MBB with desiccant or desiccator at $5\% \text{RH}$.

d. Control of assembled boards

- If the PCB soldered with the LEDs is to be subjected to other high temperature processes, the PCB need to be stored in sealed MBB with desiccant or desiccator at $5\% \text{RH}$ to ensure that all LEDs have not exceeded their floor life of 672 hours.

e. Baking is required if:

- The HIC indicator is not BROWN at 10% and is AZURE at 5%.
 - The LEDs are exposed to condition of $30^{\circ}\text{C} / 60\% \text{RH}$ at any time.
 - The LED floor life exceeded 672hrs.
- The recommended baking condition is: $60 \pm 5^{\circ}\text{C}$ for 20hrs. Baking should only be done once.

f. Storage

- The soldering terminals of these Avago LEDs are silver plated. If the LEDs are being exposed in ambient environment for too long, the silver plating might be oxidized and thus affecting its solderability performance. As such, unused LEDs must be kept in sealed MBB with desiccant or in desiccator at $5\% \text{RH}$.

3. Application precautions

- a. Drive current of the LED must not exceed the maximum allowable limit across temperature as stated in the datasheet. Constant current driving is recommended to ensure consistent performance.
- b. LED is not intended for reverse bias. Do use other appropriate components for such purpose. When driving the LED in matrix form, it is crucial to ensure that the reverse bias voltage is not exceeding the allowable limit of the LED.
- c. Avoid rapid change in ambient temperature especially in high humidity environment as this will cause condensation on the LED.
- d. If the LED is intended to be used in outdoor or harsh environment, the LED leads must be protected with suitable potting material against damages caused by rain water, oil, corrosive gases etc. It is recommended to have louver or shade to reduce direct sunlight on the LEDs.

4. Eye safety precautions

LEDs may pose optical hazards when in operation. It is not advisable to view directly at operating LEDs as it may be harmful to the eyes. For safety reasons, use appropriate shielding or personal protective equipments.

DISCLAIMER: *Avago's products and software are not specifically designed, manufactured or authorized for sale as parts, components or assemblies for the planning, construction, maintenance or direct operation of a nuclear facility or for use in medical devices or applications. Customer is solely responsible, and waives all rights to make claims against avago or its suppliers, for all loss, damage, expense or liability in connection with such use.*

For product information and a complete list of distributors, please go to our web site: www.avagotech.com

Avago, Avago Technologies, and the A logo are trademarks of Avago Technologies in the United States and other countries.
Data subject to change. Copyright © 2005-2015 Avago Technologies. All rights reserved.
AV02-4619EN - July 6, 2015

Avago
TECHNOLOGIES