

LISA4-RS

~16° spot beam with integrated pins on lens

SPECIFICATION:

Dimensions	Ø 10.0 mm
Height	7.7 mm
Fastening	pin
ROHS compliant	yes ⓘ

MATERIALS:

Component	Type	Material	Colour	Finish
LISA4-RS	Single lens	PMMA	clear	



ORDERING INFORMATION:

Component	Qty in box	MOQ	MPQ	Box weight (kg)
C17521_LISA4-RS » Box size: 430 x 390 x 215 mm	20000	1000	1000	7.5

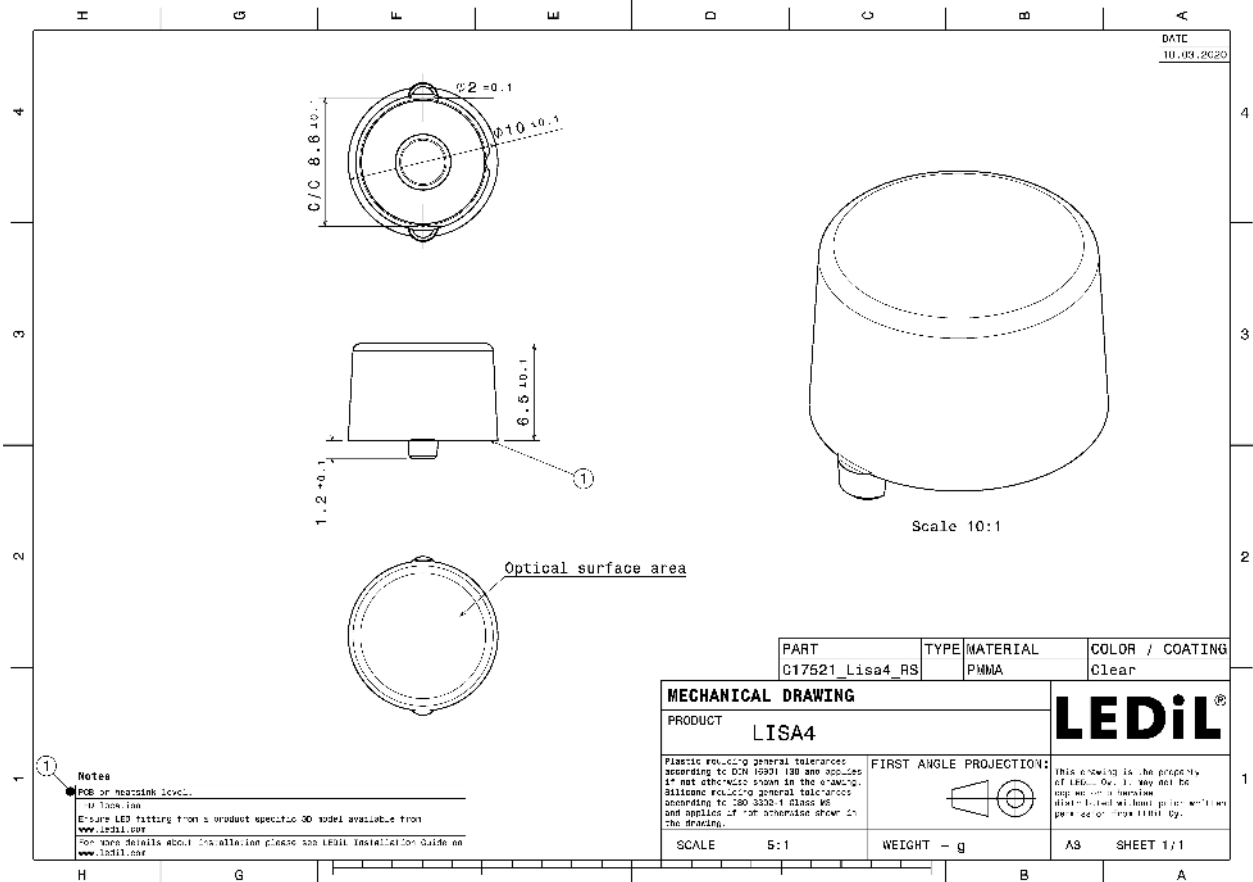

See also our general installation guide: www.ledil.com/installation_guide

OPTICAL RESULTS (SIMULATED):

CREE LED

LED XP-E2
 FWHM / FWTM 16.0° / 32.0°
 Efficiency 95 %
 Peak intensity 7.4 cd/lm
 LEDs/each optic 1
 Light colour White
 Required components:

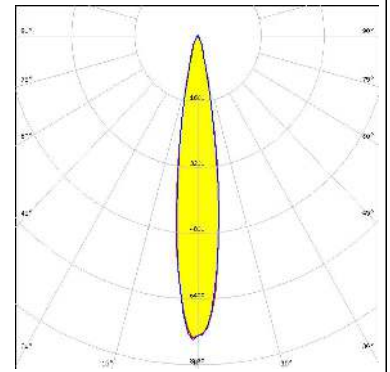

CREE LED

LED XP-G3
 FWHM / FWTM 29.0° / 60.0°
 Efficiency 94 %
 Peak intensity 2.5 cd/lm
 LEDs/each optic 1
 Light colour White
 Required components:

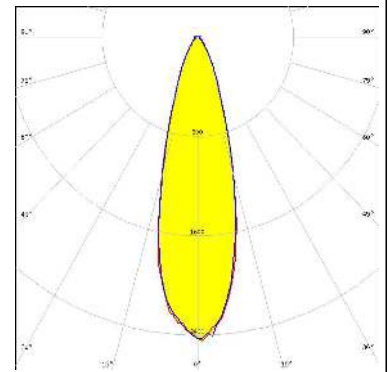

LUMILEDS

LED LUXEON HL1Z
 FWHM / FWTM 18.0° / 34.0 + 33.0°
 Efficiency 96 %
 Peak intensity 6.4 cd/lm
 LEDs/each optic 1
 Light colour White
 Required components:

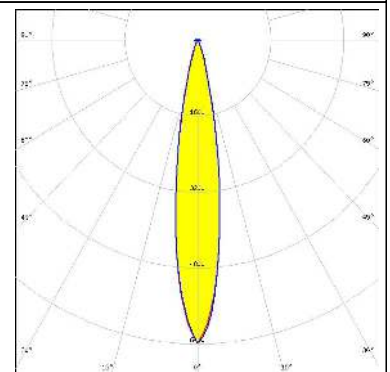

LUMILEDS

LED LUXEON Z ES
 FWHM / FWTM 18.0° / 33.0°
 Efficiency 92 %
 Peak intensity 6.7 cd/lm
 LEDs/each optic 1
 Light colour White
 Required components:

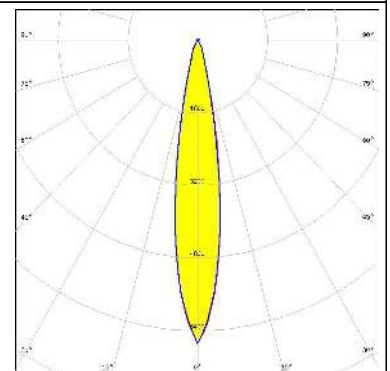

OPTICAL RESULTS (SIMULATED):

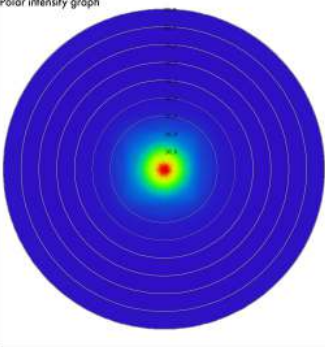
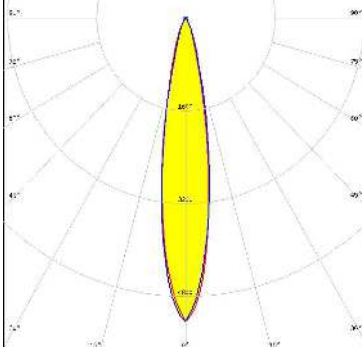
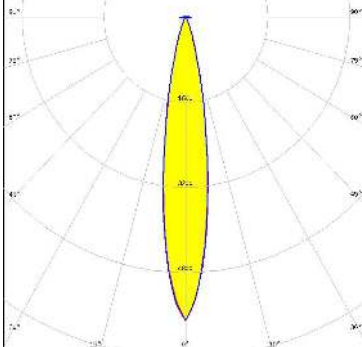
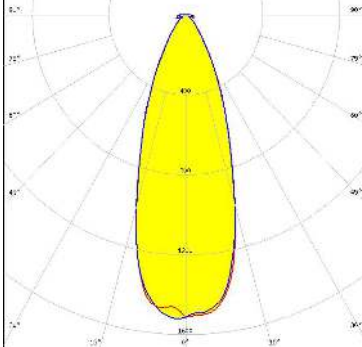
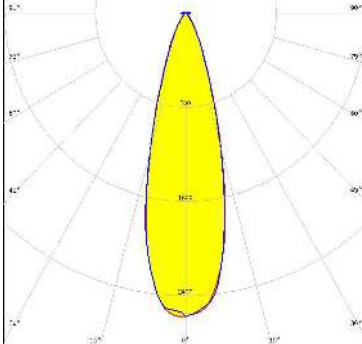
<p>LUMINUS</p> <p>LED SST-10-IR-B90 FWHM / FWTM 18.0° / 39.0° Efficiency 90 % LEDs/each optic 1 Light colour IR Required components:</p>	<p>Polar intensity graph</p> 	
<p>NICHIA</p> <p>LED NCSxE17A FWHM / FWTM 18.0° / 36.0° Efficiency 93 % Peak intensity 5.7 cd/lm LEDs/each optic 1 Light colour White Required components:</p>		
<p>NICHIA</p> <p>LED NV4WB35AM FWHM / FWTM 36.0° / 73.0° Efficiency 93 % Peak intensity 1.5 cd/lm LEDs/each optic 1 Light colour White Required components:</p>		
<p>NICHIA</p> <p>LED NVSxx19B/NVSxx19C FWHM / FWTM 29.0° / 55.0° Efficiency 91 % Peak intensity 2.6 cd/lm LEDs/each optic 1 Light colour White Required components:</p>		

OPTICAL RESULTS (SIMULATED):

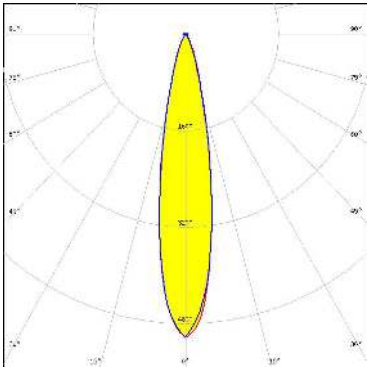
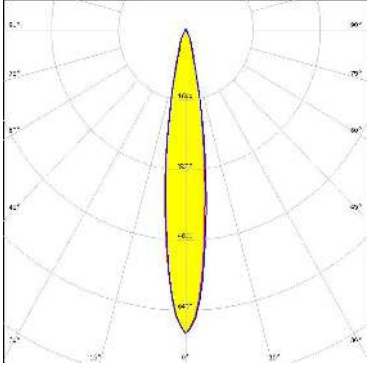
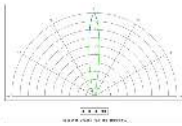
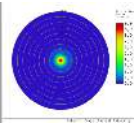
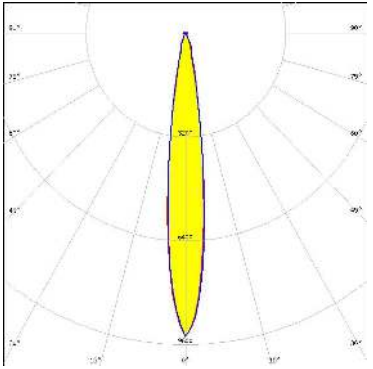
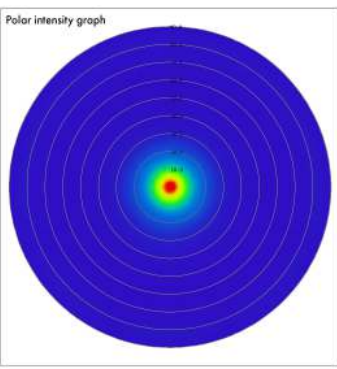
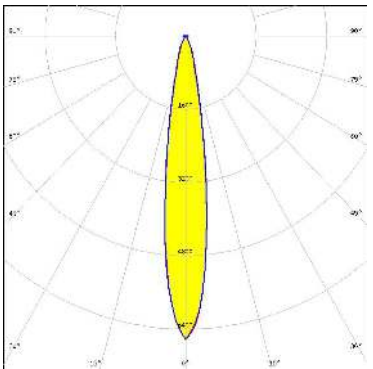
OSRAM <small>Opto Semiconductors</small>	<p>LED OSCONIQ C 2424</p> <p>FWHM / FWTM 20.0° / 41.0°</p> <p>Efficiency 95 %</p> <p>Peak intensity 5 cd/lm</p> <p>LEDs/each optic 1</p> <p>Light colour White</p> <p>Required components:</p>		
OSRAM <small>Opto Semiconductors</small>	<p>LED OSLOM SSL 80</p> <p>FWHM / FWTM 16.0° / 33.0°</p> <p>Efficiency 93 %</p> <p>Peak intensity 6.9 cd/lm</p> <p>LEDs/each optic 1</p> <p>Light colour White</p> <p>Required components:</p>		
OSRAM <small>Opto Semiconductors</small>	<p>LED SFH 4714A</p> <p>FWHM / FWTM 14.0° / 27.0°</p> <p>Efficiency 96 %</p> <p>LEDs/each optic 1</p> <p>Light colour IR</p> <p>Required components:</p>	 	
OSRAM <small>Opto Semiconductors</small>	<p>LED SFH 4770S</p> <p>FWHM / FWTM 16.0° / 34.0°</p> <p>Efficiency 93 %</p> <p>LEDs/each optic 1</p> <p>Light colour IR</p> <p>Required components:</p>	<p>Polar intensity graph</p> 	

OPTICAL RESULTS (SIMULATED):

OSRAM
Opto Semiconductors

LED Synios P2720 1/2 mm
FWHM / FWTM 15.0° / 32.0°
Efficiency 95 %
Peak intensity 7.9 cd/lm
LEDs/each optic 1
Light colour White
Required components:

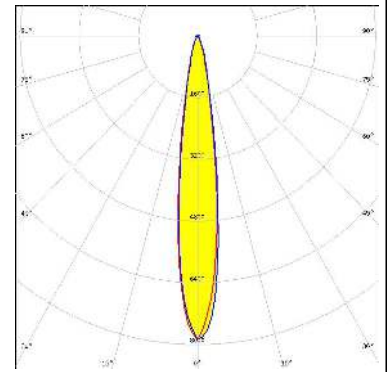

SEOL
SEOUL SEMICONDUCTOR

LED Z5M4
FWHM / FWTM 30.0° / 56.0°
Efficiency 93 %
Peak intensity 2.5 cd/lm
LEDs/each optic 1
Light colour White
Required components:

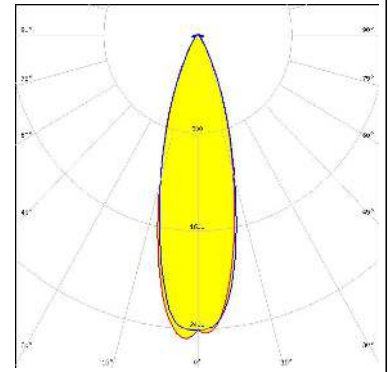

GENERAL INFORMATION:

NOTE: The typical beam angle will be changed by different color, chip size and chip position tolerance. The typical total beam angle is the full angle measured where the luminous intensity is half of the peak value.

MATERIALS:

As part of our continuous research and improvement processes, and to ensure the best possible quality and availability of our products, LEDiL reserves the right to change material grades without notice.

PRODUCT DATA USER AGREEMENT AND DISCLAIMER:

The measured data in the provided downloadable LEDiL Product Datasheets and Mechanical 2D-Drawings is rounded and provided as reference for planning. LEDiL Oy's optical specifications have been verified by conducting performance testing of the products in accordance with the company's quality system. The reported data are averaged results of multiple measurements with typical variation. LEDiL Oy reserves the right to without prior notification make changes and improvements to its products.

LEDiL Oy assumes neither warranty, nor guarantee nor any other liability of any kind for the contents and correctness of the provided data. The provided data has been generated with highest diligence but the provided data may in reality not represent the complete possible variation range of all intrinsic parameters. Therefore, in certain cases a deviation from the provided data could occur.

LEDiL Oy reserves the right to undertake technical changes of its products without further notification which could lead to changes in the provided data. LEDiL Oy assumes no liability of any kind for the possible deviation from any provided data or any other damage resulting from the usage of the provided data.

The user agrees to this disclaimer and user agreement with the download or usage of the provided files.

LEDiL Oy

Joensuunkatu 13
FI-24240 SALO
Finland

LEDiL Inc.

228 West Page Street
Suite D
Sycamore IL 60178
USA

Ledil Optics Technology (Shenzhen) Co., Ltd.

405 , Block B
Casic Motor Building
Shenzhen 518057
P.R.CHINA

Local sales and technical support

[www.ledil.com/
where_to_buy](http://www.ledil.com/where_to_buy)

Shipping locations

Salo, Finland
Hong Kong, China

Distribution Partners

[www.ledil.com/
where_to_buy](http://www.ledil.com/where_to_buy)