

THIS COPY IS PROVIDED ON A RESTRICTED BASIS AND IS NOT TO BE USED IN ANY WAY DETRIMENTAL TO THE INTERESTS OF PANDUIT CORP.

Material	High Conductivity Seamless Copper Tube
Plating	Electro-Tin
Wire Size & Type	Stranded Copper Flex Cable; 262.6 kcmil (650/24) Diesel Locomotive, 250 kcmil Class K & Class M
Wire Strip Length	1-3/4 in.
Stud Size	5/8 in.
UL Listed Wire Connector	Yes, for applications up to 35kv. Consult cable manufacturer for voltage stress relief instructions with applications greater than 2000 volts.
UL Temperature Rating	90° C
C.S.A Certified Wire Connector	Yes
Panduit Color Code on Barrel	WHITE
Panduit Die Index No. on Barrel	P66
Alternate Industry Die Index No. ( ) on Barrel	(17)

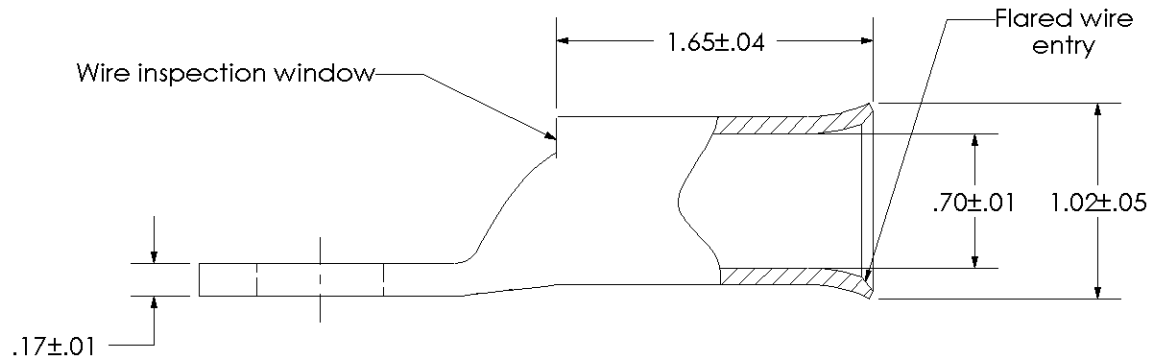
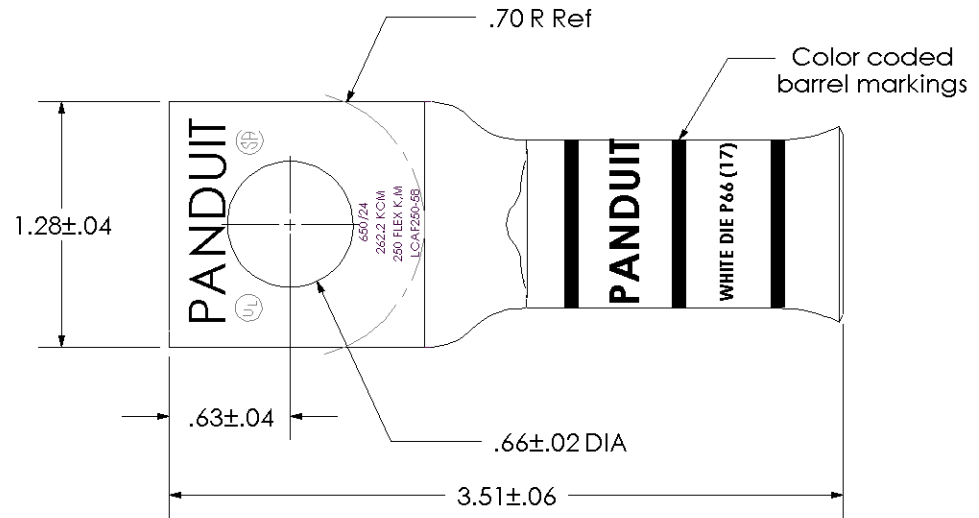

00	9/02	SAB	DRL	RELEASED	10321
REV	DATE	BY	CHK	DESCRIPTION	ECN

**PANDUIT CORP. TINLEY PARK, ILLINOIS**

LCAF250-58-X  
Copper Lug - One-Hole, Flared Barrel

SCALE N/A DRAWING NO / CAD FILE LCAF250-58-CUST