

408-8738

Revision T, Jan. 2017

www.commscope.com

PRO-CRIMPER III Hand Crimping Tool 790163-[]

1. Introduction

PRO-CRIMPER III Hand Crimping Tool Assembly 790163-[] consists of PRO-CRIMPER III Hand Tool Frame 354940-1 and die assemblies listed in Table 1.

The tool assembly is used to crimp the contacts and the internal and external strain reliefs of the modular plugs listed in Table 1. The tool frame features a stationary jaw and handle, a moving jaw and handle, and an adjustable ratchet that ensures full crimping. The tool frame holds the die assembly. Refer to Figure 1. The die assembly consists of an insulation stuffer, wire stuffer, housing support, housing guides, and mounting and retaining hardware.

Read these instructions thoroughly before using the hand tool assembly.

Note: Dimensions in this instruction sheet are in millimeters (inch). Figures and illustrations are for reference only and are not drawn to scale.

PRO-CRIMPER III hand crimping tool is commercial grade and is designed primarily for field installation, repair, maintenance work, and prototyping in industrial, commercial, and institutional applications. Products crimped with this tool will meet the crimp height requirement for hand tools in the appropriate application specification (114-series), but may not comply with other feature parameters of this document. A variety of tools are offered to satisfy performance requirements for **CommScope** Connectivity products.

For additional information, visit our website or contact your local **CommScope** account representative.

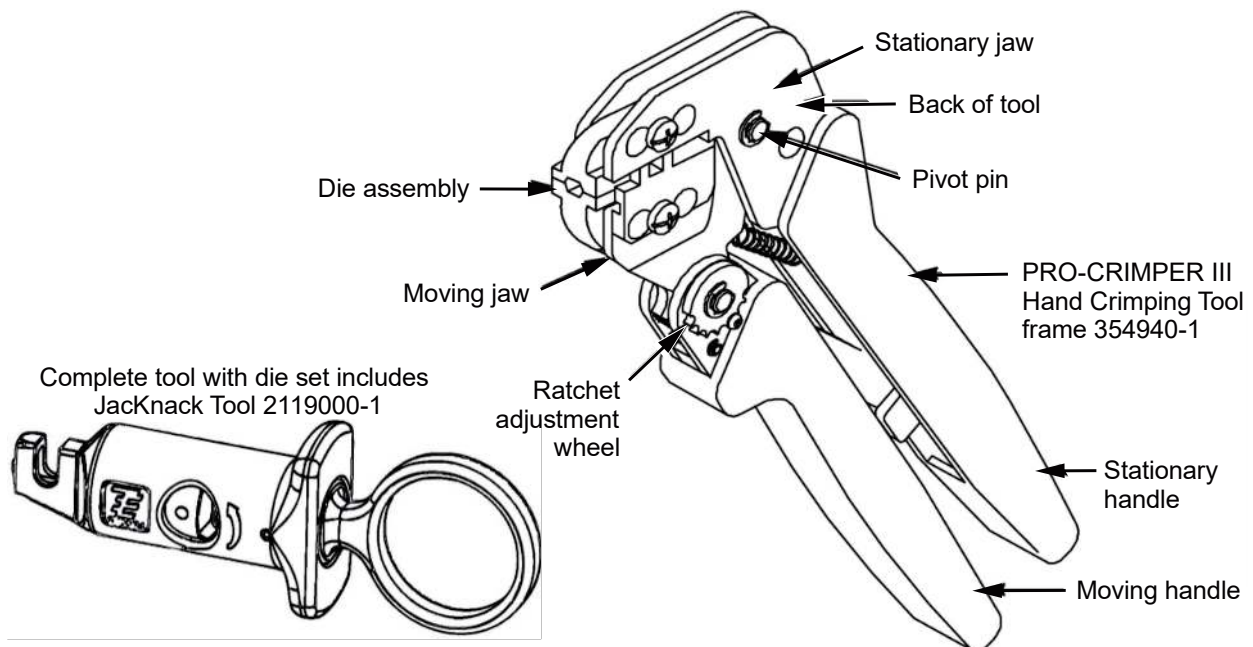

Figure 1. PRO-CRIMPER III Hand Tool

Table 1. Hand Tool Die Assemblies

Hand Tool W/Die set	Die Set (only)	MODULAR PLUG		CABLE				
		CATEGORY	PART NUMBER	TYPE	WIRE INSULATION DIAMETER (MM[IN.])	OUTSIDE DIAMETER (MM[IN.])	WIRE SIZE RANGE (AWG)	WIRE SIZE TYPE
790163-1	790163-2	5e EMT	6-2111986-[]	UTP or FTP stranded	0.89-1.09 [.035-.043]	5.1-6.0 [.201-.236]	24-26	stranded
		5e EMT	6-2111986-[]	UTP or FTP stranded	0.89-1.09 [.035-.043]	5.1-6.0 [.201-.236]	23-24	solid
		6	6-2111981-[]	UTP or FTP stranded or solid	0.89-1.09 [.035-.043]	5.1-6.0 [.201-.236]	24-26	stranded
		6	6-2111981-[]	UTP or FTP stranded or solid	0.89-1.09 [.035-.043]	5.1-6.0 [.201-.236]	23-24	solid
		6	6-2111979-[]	UTP or FTP stranded or solid	0.89-1.09 [.035-.043]	5.1-6.0 [.201-.236]	24-26	stranded
		6	6-2111979-[]	UTP or FTP stranded or solid	0.89-1.09 [.035-.043]	5.1-6.0 [.201-.236]	23-24	solid
790163-5	790163-6	5e EMT	6-2111988-3	UTP or FTP stranded	0.89-1.09 [.035-.043]	5.7-7.0 [.224-.276]	24-26	stranded
		5e EMT	6-2111988-3	UTP or FTP stranded	0.89-1.09 [.035-.043]	5.7-7.0 [.224-.276]	23-24	solid
		6	6-2111989-[]	UTP or FTP stranded or solid	0.89-1.09 [.035-.043]	5.7-7.0 [.224-.276]	24-26	stranded
		6	6-2111989-[]	UTP or FTP stranded or solid	0.89-1.09 [.035-.043]	5.7-7.0 [.224-.276]	23-24	solid
		6A	6-2111984-[]	PiMF Solid or Stranded	0.89-1.09 [.035-.043]	5.7-7.0 [.224-.276]	24-26	stranded
		6A	6-2111984-[]	PiMF Solid or Stranded	0.89-1.09 [.035-.043]	5.7-7.0 [.224-.276]	23-24	solid
790163-7	790163-8	5e EMT	6-2111976-[]	UTP or FTP stranded	0.89-1.09 [.035-.043]	4.7-5.5 [.185-.217]	24-26	stranded
		5e EMT	6-2111976-[]	UTP or FTP stranded	0.89-1.09 [.035-.043]	4.7-5.5 [.185-.217]	23-24	solid
		6	6-2111977-[]	UTP or FTP stranded or solid	0.89-1.09 [.035-.043]	4.7-5.5 [.185-.217]	24-26	stranded
		6	6-2111977-[]	UTP or FTP stranded or solid	0.89-1.09 [.035-.043]	4.7-5.5 [.185-.217]	23-24	solid
1-790163-0	1-790163-1	6	1933433-1	UTP or FTP stranded or solid	1.12-1.22 [.044-.048]	6.99-7.87 [.275-.310]	22-28	stranded
		6	1933433-1	UTP or FTP stranded or solid	1.12-1.22 [.044-.048]	6.99-7.87 [.275-.310]	22-28	solid
		6	1499598	UTP or FTP stranded or solid	1.22-1.32 [.048-.052]	6.99-7.87 [.275-.310]	22-28	stranded
		6	1499598	UTP or FTP stranded or solid	1.22-1.32 [.048-.052]	6.99-7.87 [.275-.310]	22-28	solid

* Includes 2119000-1 JackKnack Tool (Instruction Sheet 408-10326)

† For additional modular plug part numbers, visit our website or contact your local **CommScope** account representative.

2. How to Contact Us

- To find out more about **CommScope**® products, visit us on the web at www.commscope.com/
- For technical assistance:
 - Within the United States, contact your local account representative or technical support at 1-800-344-0223. Outside the United States, contact your local account representative or **PartnerPRO**™ Network Partner.
 - Within the United States, report any missing/damaged parts or any other issues to **CommScope** Customer Claims at 1-866-539-2795 or email to claims@commscope.com. Outside the United States, contact your local account representative or **PartnerPRO** Network Partner.

3. Reference Material

PROPER USE GUIDELINES: Cumulative trauma disorders can result from the prolonged use of manually powered hand tools. Hand tools are intended for occasional use and low volume applications. A wide selection of powered application equipment for extended-use, production operations is available.

Replacement

Customer-replaceable parts are shown in Figure 1. Available separately, PRO-CRIMPER III Hand Tool Repair Kit 679221-1 includes a replacement nut and a variety of pins, rings, screws, and springs. If the die assembly is damaged or worn excessively, it must be replaced. Order the repair kit and replaceable parts through your local **CommScope** account representative.

3.1 Revision Summary

- Rebranded to CommScope®

4. Installation and Removal of Die Assembly

1. Close the tool handles until the ratchet releases, then allow the handles to open fully. If present, remove both retaining screws from the tool frame.
2. Orient the insulation stuffer as shown in Figure 2, and insert it into the stationary jaw of the tool frame. Align the holes with the associated holes in the tool frame. Insert the short retaining pins and short retaining screw into the holes in the tool frame. Tighten the screw.
3. Orient the housing support as shown in Figure 2, and insert it into the moving jaw of the tool frame. Align the holes with the associated holes in the tool frame. Orient the right housing guide as shown, and mount it onto the tool frame using the long retaining pins. Insert the long retaining screw through the hole in the right housing guide. Tighten the screw.
4. Refer to Figure 2. Orient the left housing guide as shown, and secure it onto the tool frame using the tension adjusting nut. Tighten the tension adjusting nut using an assembled modular plug connector assembly.

Note: Adjust the tension adjusting nut to allow the assembly to fit (snugly).

5. Carefully close the tool handles, making sure that the parts align properly.
6. To disassemble, close the tool handles until the ratchet releases. Remove the nut, screws, housing guides, retaining pins, housing support, and insulation stuffer out of the tool frame jaws.

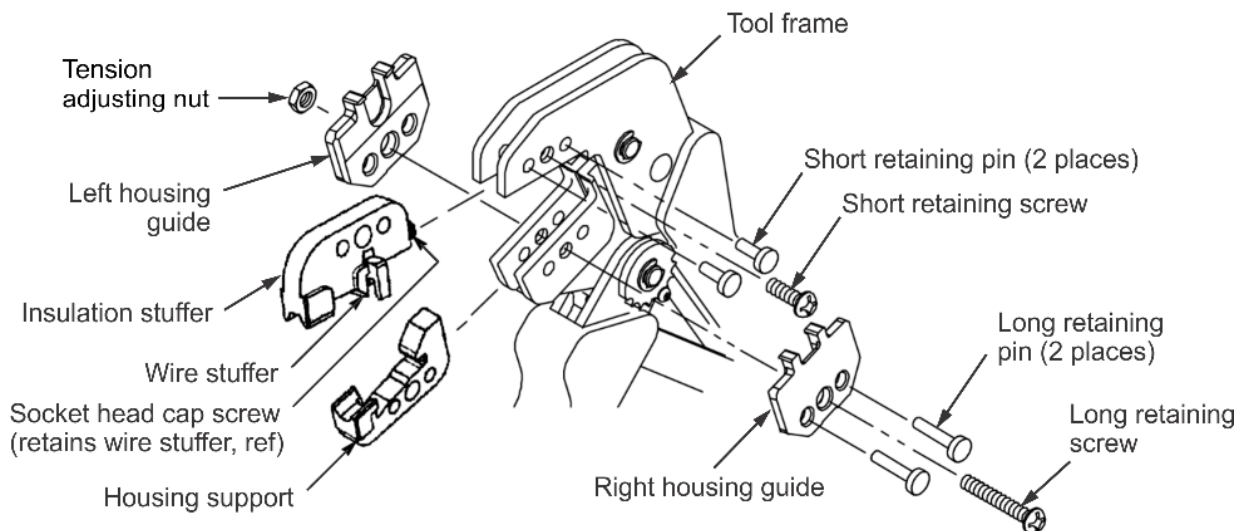

Figure 2. Tool Setup

5. Crimping Procedure

Before proceeding, refer to the applicable Application Specification: 114-22008 (Category 5E EMT) or 114-13035 and 114-93006 (Category 6 shielded), and ensure the following:

- Modular plug and cable are compatible
- Cable polarity is properly maintained
- Modular plug is properly crimped and assembled

CAUTION: Make sure that the modular plug shield is fully bottomed onto the body. With some cables containing shielded twisted pairs, this is especially IMPORTANT to check.

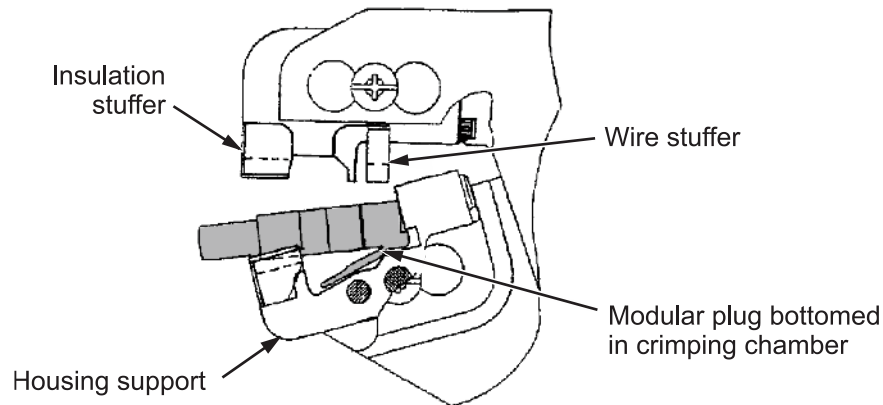

Figure 3. Position of Modular Plug Before Crimping

1. Close the tool handles until the ratchet releases, then allow the handles to open FULLY.
2. Hold the tool so that the back is facing you. Insert the modular plug (including shield and cable) in the crimping chamber until it bottoms. Refer to Figure 3.
3. While holding the assembly, carefully close the tool handles until the ratchet releases, then allow the handles to open FULLY.

Note: This tool terminates three areas of the modular plug. For proper alignment, make sure to apply forward pressure on the cable while closing the tool handles.

4. Remove the modular plug from the tool, and make sure that the crimp requirements are met according to the applicable application specification (refer to first paragraph of Section 5).

If necessary, adjust the tool ratchet according to Paragraph 6.1 to obtain the proper crimp height.

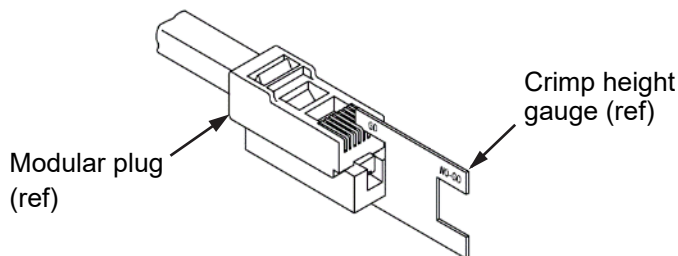

Figure 4. Crimp Height Gauge

Note: Crimp Height Gauge 904170-1 is to be used as a quick verification of acceptable crimp height as shown in Figure 4. Refer to Instruction Sheet 408-4389 for instructions on using the gauge.

6. Adjustments

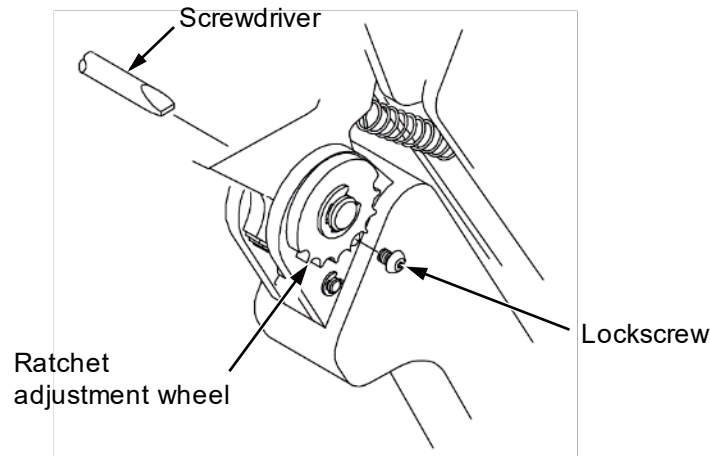

Figure 5. Ratchet Adjustment

6.1 Ratchet Adjustment

The tool ratchet mechanism features an adjustment wheel with numbered settings, as shown in Figure 5. The adjustment wheel controls the amount of handle pressure exerted on the jaws during crimping. If the crimp is not acceptable, adjust the ratchet as follows:

1. Remove the lockscrew from the ratchet adjustment wheel.
2. With a screwdriver, adjust the ratchet wheel from the front of the tool.
3. Observe the ratchet adjustment wheel. If a tighter crimp is required, rotate the adjustment wheel counterclockwise to a higher-numbered setting. If a looser crimp is required, rotate the adjustment wheel clockwise to a lower-numbered setting.
4. Re-assemble the lockscrew.
5. Make a sample crimp. If the crimp is acceptable, the adjustment setting is correct. If the crimp is unacceptable, continue to adjust the ratchet, and again measure a sample crimp. If a proper crimp cannot be obtained, the tool or die assembly must be replaced. Refer to Section 3.

Note: The tool is set at the No. 7 ratchet setting at the factory. This setting assures the proper crimp height for solid wire and accounts for the maximum tolerance in the tooling. You can readjust your tool to a lower setting, (No. 4, minimum), as long as you achieve the proper insertion depth, 6.02 ± 0.13 [.237 \pm .005]. See the applicable application specification.

6.2 Wire Stuffer Adjustment

If the wire stuffer is not assembled onto the insulation stuffer or if correct alignment of these two parts is unsure, proceed with the following:

1. Install the wire stuffer onto the insulation stuffer using the 4-40 UNC .621 in. socket head cap screw included with the die assembly. Refer to Figure 2.

Note: DO NOT tighten the screw. If the screw is tight, loosen it.

2. Close the tool handles until the ratchet releases, then allow the handles to open FULLY. Insert a modular plug (without cable) into the crimping chamber.
3. Close the tool handles, and hold.

4. Insert a key into the socket head cap screw (retaining the wire stuffer), and tighten the screw.
5. Allow the handles to open, and remove the crimped modular plug. The wire stuffer will be held in its proper position.

7. Maintenance and Inspection

7.1 Daily Maintenance

It is recommended that the tool operator be made aware of, and are responsible for, the following steps of daily maintenance.

1. Remove dust, moisture, and any other contaminants from the tool with a clean, soft brush, or a clean, soft, lint-free cloth. DO NOT use hard or abrasive objects that could damage the tool.
2. Make certain that the retaining pins are in place and that they are secured with retaining rings.
3. All pins, pivot points, and bearing surfaces should be protected with a thin coat of any good grade SAE 20 motor oil. DO NOT oil excessively. When the tool is not in use, keep the handles closed to prevent objects from becoming lodged in the jaws.
4. Store the tool in a clean, dry area.

7.2 Periodic Inspection

Regular inspection of the tool should be performed by quality control personnel. A record of the scheduled inspections should remain with the tool or be supplied to personnel responsible for the tool. Inspection frequency should be based on amount of use, working conditions, operator training and skill, and established company standards.

7.3 Visual Inspection

1. Remove all lubrication and accumulated film by immersing the tool (handles partially closed) in a suitable commercial degreaser that will NOT affect paint or plastic material.
2. Make certain that the retaining pins are in place and that they are secured with retaining rings.
3. Close the tool handles until the ratchet releases, and then allow the handles to open freely. If they do not open quickly and fully, the spring is defective and must be replaced.
4. Inspect the tool frame for wear or damage, paying particular attention to the tool jaws and the pivot points. If damage is evident, replace it. If damage is not evident, lubricate the pivot point and return the tool to service.
5. Check the die assembly on a regular basis to ensure it has not become worn or damaged. Inspect the crimping sections for flattened, chipped, worn, or broken areas. If damage is evident, replace the die assembly.

Tooling Used with Dies 1790163-[]

**PRO-CRIMPER III
Hand Tool Frame 354940-1**
(Instruction Sheet 408-9930)

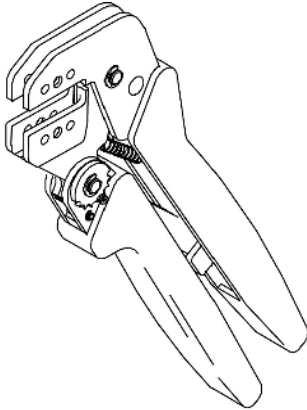

626 Adapter 679304-1
(Instruction Sheet 408-4070)

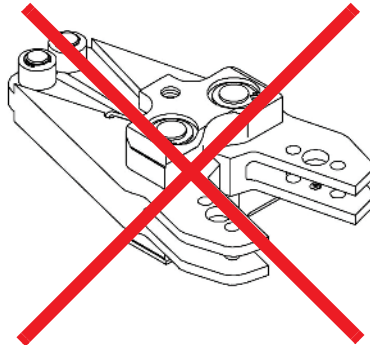

SDE-SA Hand Tool 9-1478240-0
(Instruction Sheet 408-8851)

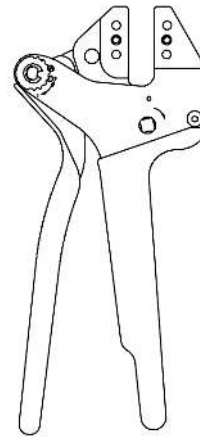

SDE Bench Terminator 1490076-2
(Customer Manual 409-10052)



**Pneumatic Safety Crimping Machine
AT-SC MK II 1-528050-0**
(Customer Manual 412-94233)



Closed Head Assembly 2031460-1 **"C"-Head Assembly 2031450-1**
(Instruction Sheet 408-10312) (Instruction Sheet 408-10311)

**Electro-Hydraulic
(BT 3500 Battery-Hydraulic)
Hand Tool Kits 2031400-[]**
(Customer Manual 409-10095)

