

RF LDMOS Wideband Integrated Power Amplifiers

The MW6IC2240N wideband integrated circuit is designed with on-chip matching that makes it usable from 2110 to 2170 MHz. This multi-stage structure is rated for 26 to 32 Volt operation and covers all typical cellular base station modulation formats including TD-SCDMA.

Final Application

- Typical 2-Carrier W-CDMA Performance: $V_{DD} = 28$ Volts, $I_{DQ1} = 210$ mA, $I_{DQ2} = 370$ mA, $P_{out} = 4.5$ Watts Avg., $f = 2157$ MHz, Channel Bandwidth = 3.84 MHz, PAR = 8.5 dB @ 0.01% Probability on CCDF.
 Power Gain — 28 dB
 Power Added Efficiency — 15%
 IM3 @ 10 MHz Offset — -43 dBc in 3.84 MHz Bandwidth
 ACPR @ 5 MHz Offset — -46 dBc in 3.84 MHz Bandwidth

Driver Application

- Typical 2-Carrier W-CDMA Performance: $V_{DD} = 28$ Volts, $I_{DQ1} = 300$ mA, $I_{DQ2} = 320$ mA, $P_{out} = 25$ dBm, Full Frequency Band (2110-2170 MHz), Channel Bandwidth = 3.84 MHz, PAR = 8.5 dB @ 0.01% Probability on CCDF.
 Power Gain — 29 dB
 IM3 @ 10 MHz Offset — -59 dBc in 3.84 MHz Bandwidth
 ACPR @ 5 MHz Offset — -62 dBc in 3.84 MHz Bandwidth
- Capable of Handling 3:1 VSWR, @ 28 Vdc, 2170 MHz, 20 Watts CW Output Power
- Stable into a 3:1 VSWR. All Spurs Below -60 dBc @ 100 mW to 10 Watts CW P_{out} .

Features

- Characterized with Series Equivalent Large-Signal Impedance Parameters and Common Source Scattering Parameters
- On-Chip Matching (50 Ohm Input, DC Blocked, >3 Ohm Output)
- Integrated Quiescent Current Temperature Compensation with Enable/Disable Function (1)
- Integrated ESD Protection
- 225°C Capable Plastic Package
- RoHS Compliant
- In Tape and Reel. R1 Suffix = 500 Units per 44 mm, 13 inch Reel

MW6IC2240NBR1
MW6IC2240GNBR1

2110-2170 MHz, 4.5 W AVG., 28 V
2 x W-CDMA
RF LDMOS WIDEBAND
INTEGRATED POWER AMPLIFIERS

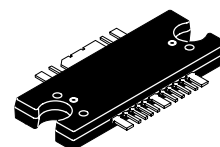

CASE 1329-09
TO-272 WB-16
PLASTIC
MW6IC2240NBR1

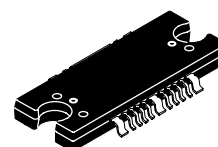

CASE 1329A-04
TO-272 WB-16 GULL
PLASTIC
MW6IC2240GNBR1

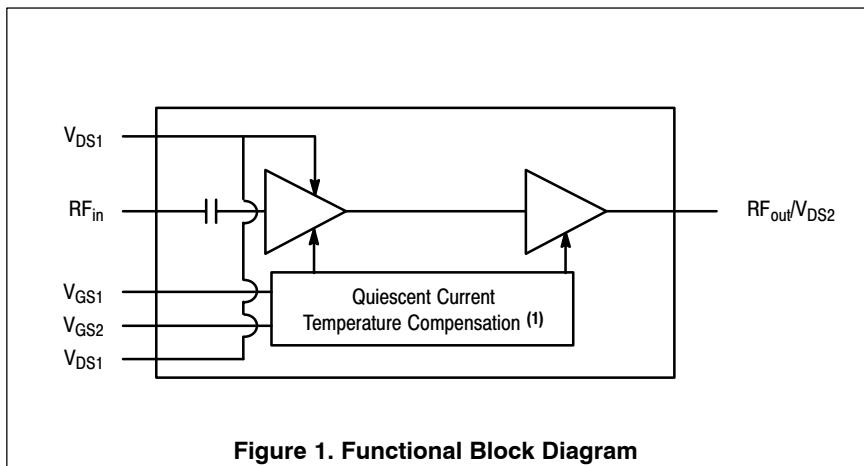

Figure 1. Functional Block Diagram

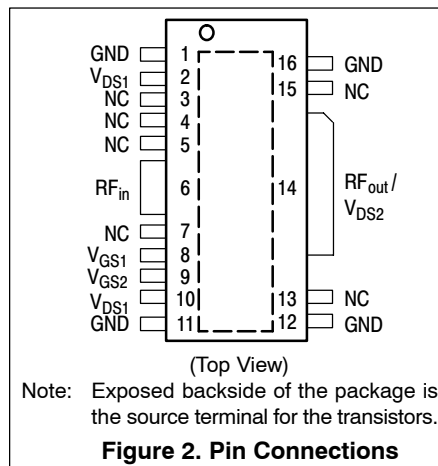

Figure 2. Pin Connections

1. Refer to AN1977, *Quiescent Current Thermal Tracking Circuit in the RF Integrated Circuit Family* and to AN1987, *Quiescent Current Control for the RF Integrated Circuit Device Family*. Go to <http://www.freescale.com/rf>. Select Documentation/Application Notes - AN1977 or AN1987.

Table 1. Maximum Ratings

Rating	Symbol	Value	Unit
Drain-Source Voltage	V_{DSS}	-0.5, +68	Vdc
Gate-Source Voltage	V_{GS}	-0.5, +6	Vdc
Storage Temperature Range	T_{stg}	-65 to +150	°C
Case Operating Temperature	T_C	150	°C
Operating Junction Temperature (1,2)	T_J	225	°C
Input Power	P_{in}	23	dBm

Table 2. Thermal Characteristics

Characteristic	Symbol	Value (2,3)	Unit
Thermal Resistance, Junction to Case	$R_{\theta JC}$		°C/W
W-CDMA Application ($P_{out} = 4.5$ W Avg.)	Stage 1, 28 Vdc, $I_{DQ} = 210$ mA Stage 2, 28 Vdc, $I_{DQ} = 370$ mA	1.8 1.0	
W-CDMA Application ($P_{out} = 40$ W CW)	Stage 1, 28 Vdc, $I_{DQ} = 110$ mA Stage 2, 28 Vdc, $I_{DQ} = 370$ mA	2.0 0.87	

Table 3. ESD Protection Characteristics

Test Methodology	Class
Human Body Model (per JESD22-A114)	1A (Minimum)
Machine Model (per EIA/JESD22-A115)	A (Minimum)
Charge Device Model (per JESD22-C101)	III (Minimum)

Table 4. Moisture Sensitivity Level

Test Methodology	Rating	Package Peak Temperature	Unit
Per JESD 22-A113, IPC/JEDEC J-STD-020	3	260	°C

Table 5. Electrical Characteristics ($T_C = 25^\circ\text{C}$ unless otherwise noted)

Characteristic	Symbol	Min	Typ	Max	Unit
----------------	--------	-----	-----	-----	------

Functional Tests (In Freescale Wideband 2110-2170 MHz Test Fixture, 50 ohm system) $V_{DD} = 28$ Vdc, $I_{DQ1} = 210$ mA, $I_{DQ2} = 370$ mA, $P_{out} = 4.5$ W Avg., $f = 2157$ MHz, 2-Carrier W-CDMA, 3.84 MHz Channel Bandwidth Carriers. ACPR measured in 3.84 MHz Channel Bandwidth @ ± 5 MHz Offset. IM3 measured in 3.84 MHz Channel Bandwidth @ ± 10 MHz Offset. PAR = 8.5 dB @ 0.01% Probability on CCDF.

Power Gain	G_{ps}	25.5	28	30	dB
Power Added Efficiency	PAE	13.7	15	—	%
Intermodulation Distortion	IM3	—	-43	-40	dBc
Adjacent Channel Power Ratio	ACPR	—	-46	-43	dBc
Input Return Loss	IRL	—	-15	-10	dB

1. Continuous use at maximum temperature will affect MTTF.
2. MTTF calculator available at <http://www.freescale.com/rf>. Select Software & Tools/Development Tools/Calculators to access MTTF calculators by product.
3. Refer to AN1955, *Thermal Measurement Methodology of RF Power Amplifiers*. Go to <http://www.freescale.com/rf>. Select Documentation/Application Notes - AN1955.

(continued)

Table 5. Electrical Characteristics ($T_C = 25^\circ\text{C}$ unless otherwise noted) (continued)

Characteristic	Symbol	Min	Typ	Max	Unit
Typical Performances (In Freescale Test Fixture, 50 ohm system) $V_{DD} = 28\text{ Vdc}$, $I_{DQ1} = 210\text{ mA}$, $I_{DQ2} = 370\text{ mA}$, 2110 MHz < Frequency < 2170 MHz					
Video Bandwidth (Tone Spacing from 100 kHz to VBW) $\Delta\text{IMD3} = \text{IMD3 @ VBW frequency} - \text{IMD3 @ 100 kHz} < 1\text{ dBc}$ (both sidebands)	VBW	—	30	—	MHz
Quiescent Current Accuracy over Temperature with 18 k Ω Gate Feed Resistors (-10 to 85°C) (1)	ΔI_{QT}	—	± 5	—	%
Gain Flatness in 30 MHz Bandwidth @ $P_{out} = 1\text{ W CW}$	G_F	—	0.2	—	dB
Deviation from Linear Phase in 30 MHz Bandwidth @ $P_{out} = 1\text{ W CW}$	Φ	—	± 1	—	°
Delay @ $P_{out} = 1\text{ W CW}$ Including Output Matching	Delay	—	2.8	—	ns
Part-to-Part Phase Variation @ $P_{out} = 1\text{ W CW}$	$\Delta\Phi$	—	± 9	—	°

Table 6. Electrical Characteristics ($T_C = 25^\circ\text{C}$ unless otherwise noted)

Characteristic	Symbol	Min	Typ	Max	Unit
Typical Performances (In Freescale Test Fixture, 50 ohm system) $V_{DD} = 28\text{ Vdc}$, $I_{DQ1} = 110\text{ mA}$, $I_{DQ2} = 370\text{ mA}$, 2110 MHz < Frequency < 2170 MHz					
Saturated Pulsed Output Power (8 μsec (on), 1 msec (off))	P_{sat}	—	60	—	W

1. Refer to AN1977, *Quiescent Current Thermal Tracking Circuit in the RF Integrated Circuit Family* and to AN1987, *Quiescent Current Control for the RF Integrated Circuit Device Family*. Go to <http://www.freescale.com/rf>. Select Documentation/Application Notes - AN1977 or AN1987.

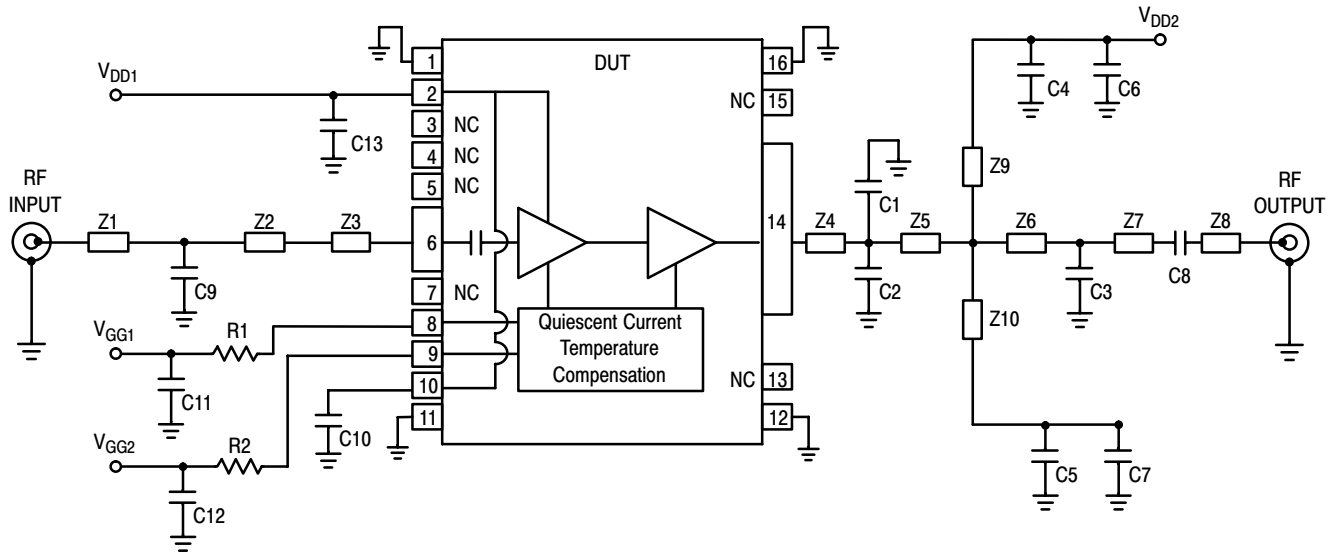

- | | | | |
|-----|---------------------------|---------|--|
| Z1* | 1.73" x 0.090" Microstrip | Z7* | 0.94" x 0.090" Microstrip |
| Z2* | 0.47" x 0.090" Microstrip | Z8 | 0.34" x 0.090" Microstrip |
| Z3 | 0.13" x 0.040" Microstrip | Z9, Z10 | 1.00" x 0.080" Microstrip |
| Z4* | 0.22" x 0.315" Microstrip | PCB | Taconic TLX8-0300, 0.030", $\epsilon_r = 2.55$ |
| Z5* | 0.34" x 0.315" Microstrip | | |
| Z6* | 0.34" x 0.090" Microstrip | | |
- * Variable for tuning

Figure 3. MW6IC2240NBR1(GNBR1) Test Circuit Schematic

Table 7. MW6IC2240NBR1(GNBR1) Test Circuit Component Designations and Values

Part	Description	Part Number	Manufacturer
C1, C2	1.5 pF Chip Capacitors	ATC100B1R5BT500XT	ATC
C3	1.8 pF Chip Capacitor	ATC100B1R8BT500XT	ATC
C4, C5	6.8 pF Chip Capacitors	ATC100B6R8CT500XT	ATC
C6, C7, C10, C11, C12, C13	4.7 μ F Chip Capacitors	C4532X5R1H475MT	TDK
C8	8.2 pF Chip Capacitor	ATC100B8R2CT500XT	ATC
C9	0.5 pF Chip Capacitor	ATC100B0R5BT500XT	ATC
R1	18 k Ω , 1/4 W Chip Resistor	CRCW12061802FKEA	Vishay
R2	8.2 k Ω , 1/4 W Chip Resistor	CRCW12068201FKEA	Vishay

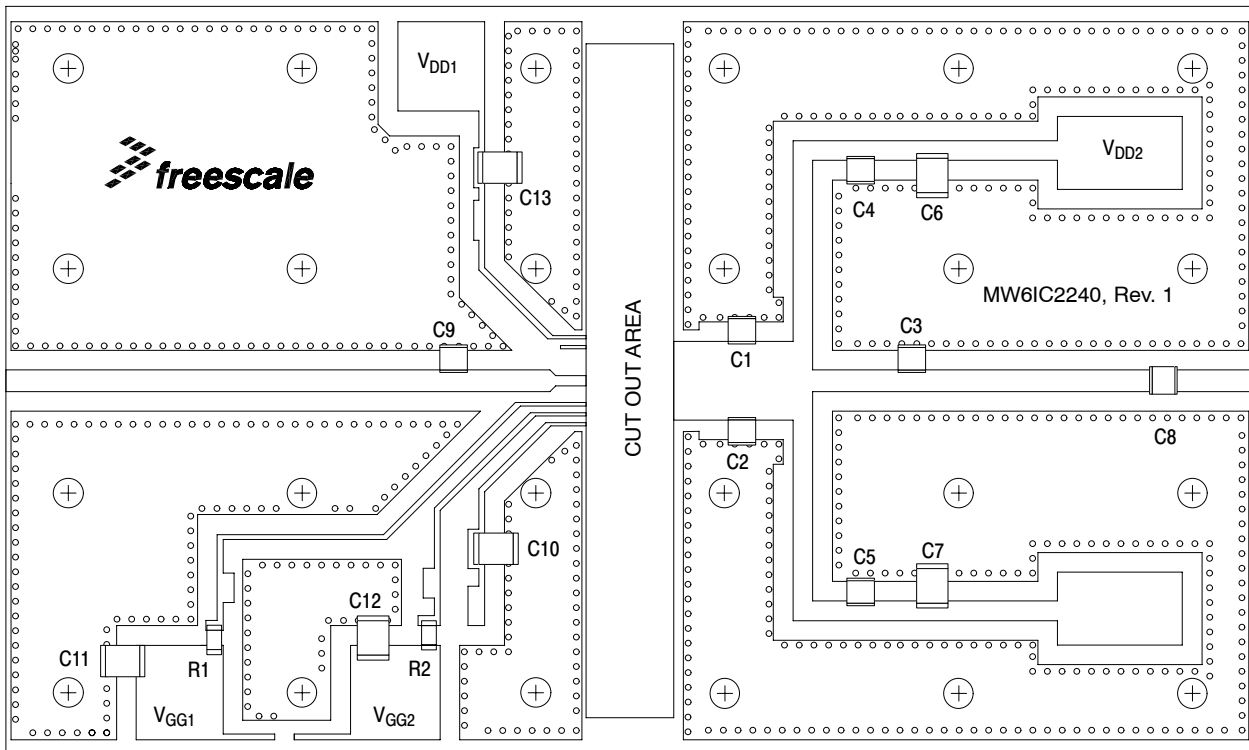

Figure 4. MW6IC2240NBR1(GNBR1) Test Circuit Component Layout

TYPICAL CHARACTERISTICS

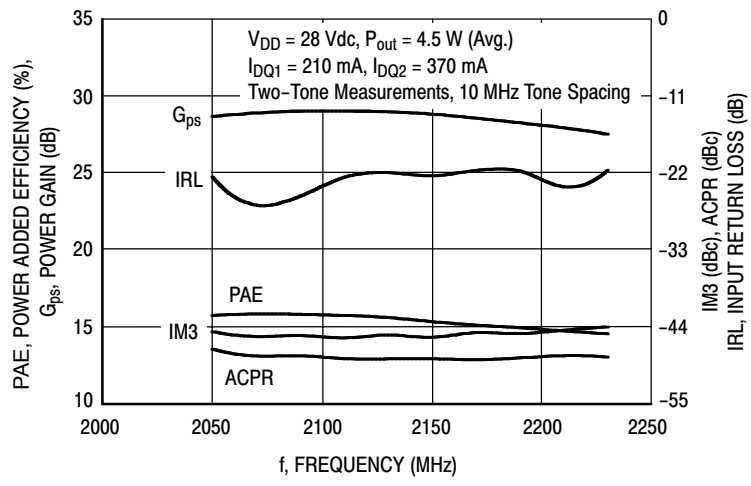

Figure 5. 2-Carrier W-CDMA Wideband Performance @ $P_{out} = 4.5$ Watts Avg.

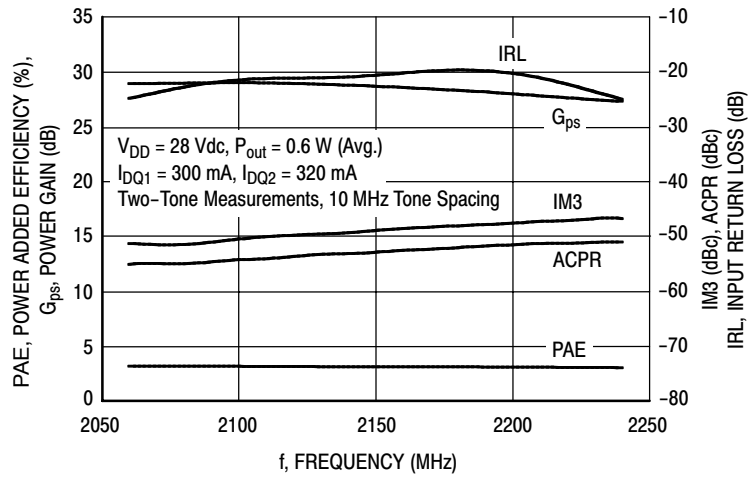

Figure 6. 2-Carrier W-CDMA Wideband Performance @ $P_{out} = 0.6$ Watts Avg.

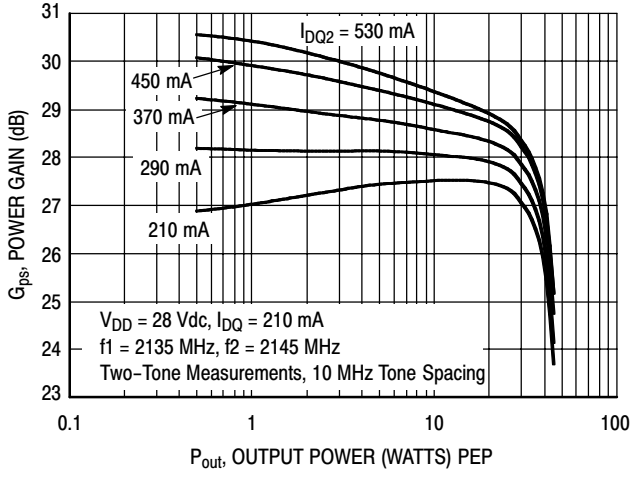

Figure 7. Two-Tone Power Gain versus Output Power

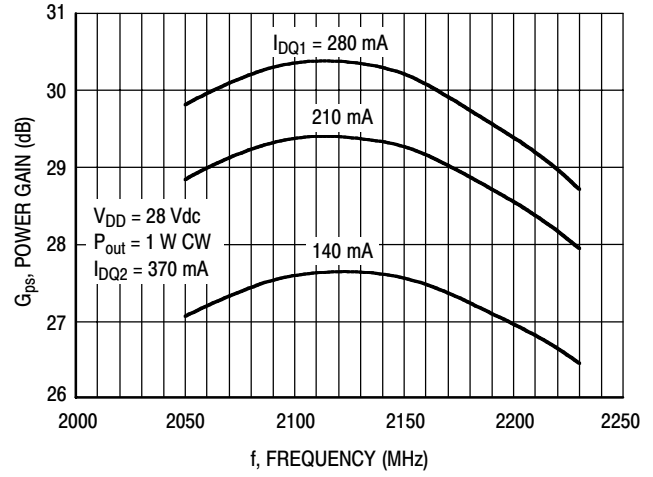

Figure 8. Frequency Response versus Current

TYPICAL CHARACTERISTICS

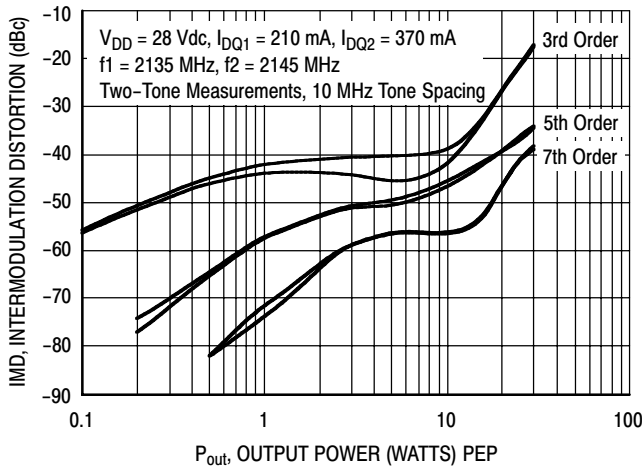

Figure 9. Intermodulation Distortion Products versus Output Power

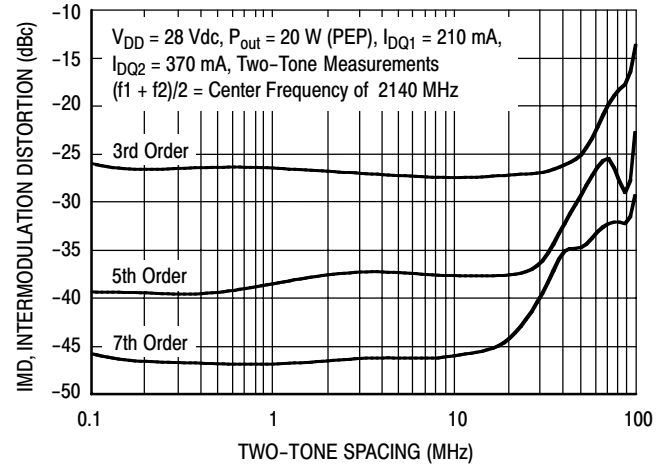

Figure 10. Intermodulation Distortion Products versus Tone Spacing

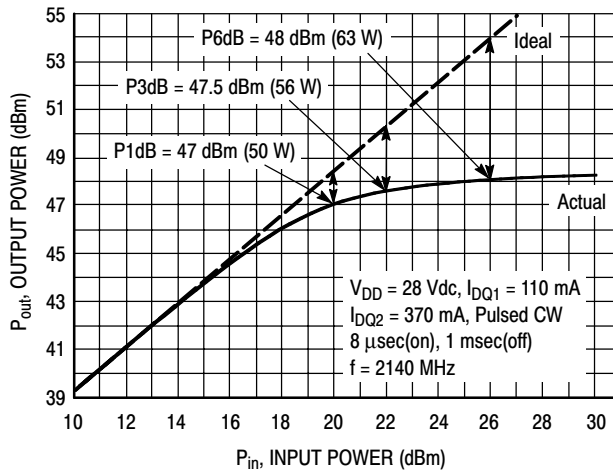

Figure 11. Pulsed CW Output Power versus Input Power

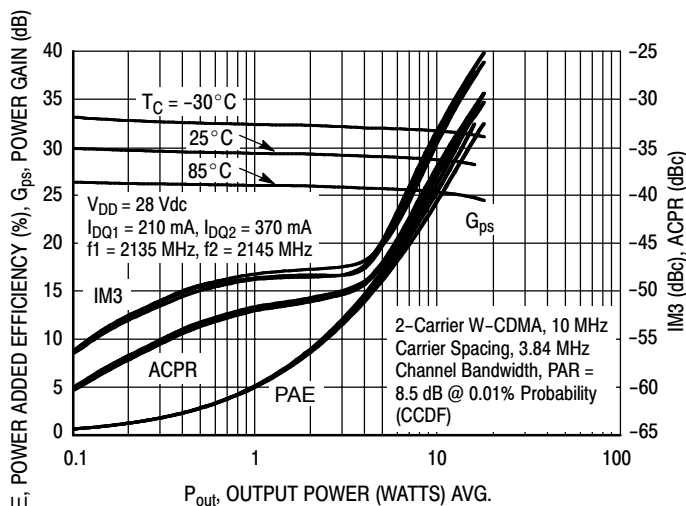

Figure 12. 2-Carrier W-CDMA ACPR, IM3, Power Gain and Power Added Efficiency versus Output Power

TYPICAL CHARACTERISTICS

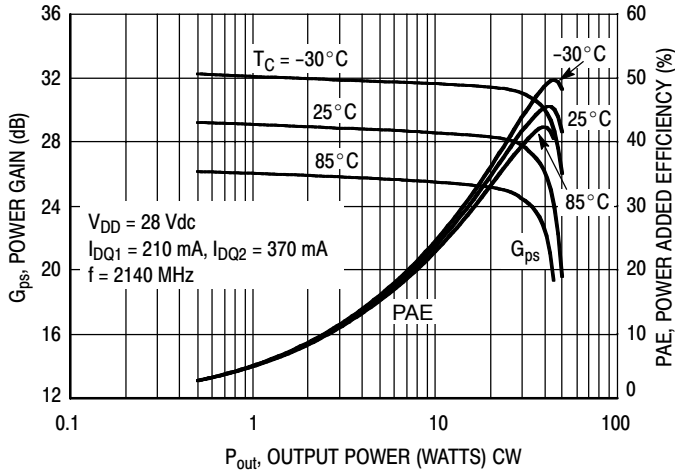

Figure 13. Power Gain and Power Added Efficiency versus Output Power

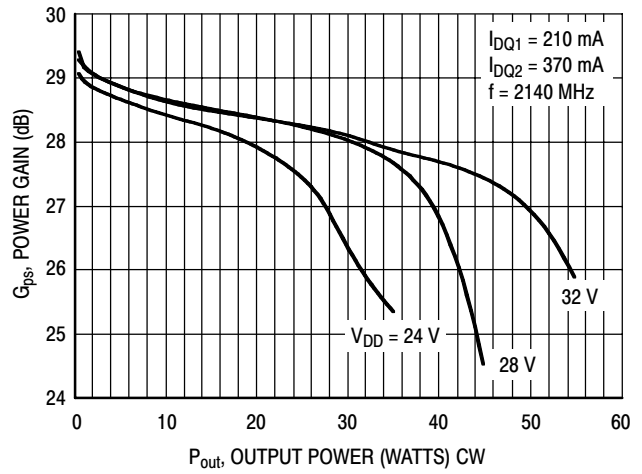
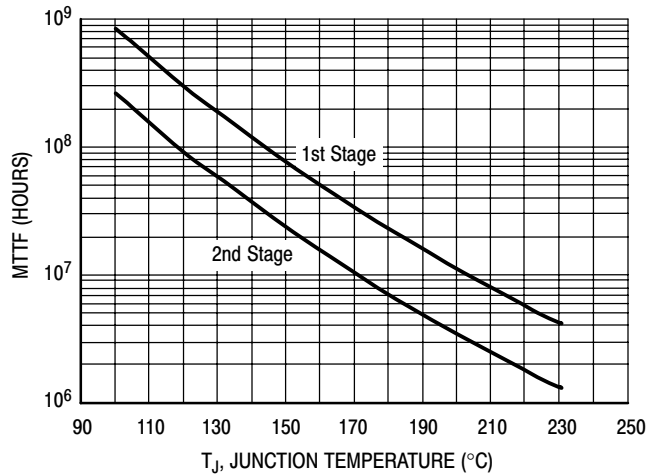

Figure 14. Power Gain versus Output Power



This above graph displays calculated MTTF in hours when the device is operated at $V_{DD} = 28$ Vdc, $P_{out} = 4.5$ W Avg., and PAE = 15%.

MTTF calculator available at <http://www.freescale.com/rf>. Select Tools/Software/Application Software/Calculators to access the MTTF calculators by product.

Figure 15. MTTF versus Junction Temperature

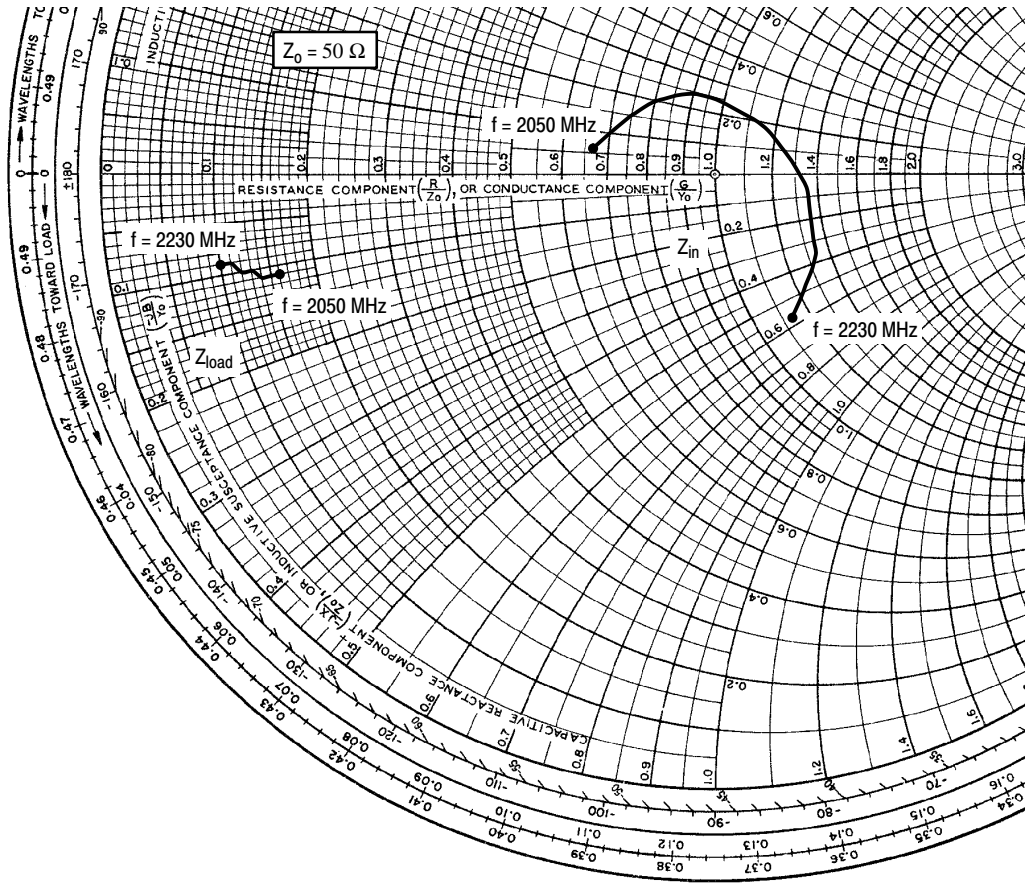

$V_{DD} = 28 \text{ Vdc}$, $I_{DQ1} = 210 \text{ mA}$, $I_{DQ2} = 370 \text{ mA}$, $P_{out} = 4.5 \text{ W Avg.}$

f MHz	Z_{in} Ω	Z_{load} Ω
2050	$33.723 + j3.048$	$7.971 - j5.705$
2080	$38.052 + j8.201$	$7.559 - j5.532$
2110	$45.972 + j12.306$	$7.117 - j5.345$
2140	$59.075 + j9.272$	$6.642 - j5.119$
2170	$68.368 - j3.227$	$6.132 - j4.891$
2200	$67.177 - j19.071$	$5.626 - j4.619$
2230	$58.213 - j28.879$	$5.118 - j4.305$

Z_{in} = Device input impedance as measured from gate to ground.

Z_{load} = Test circuit impedance as measured from drain to ground.

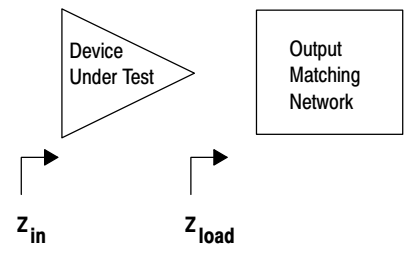
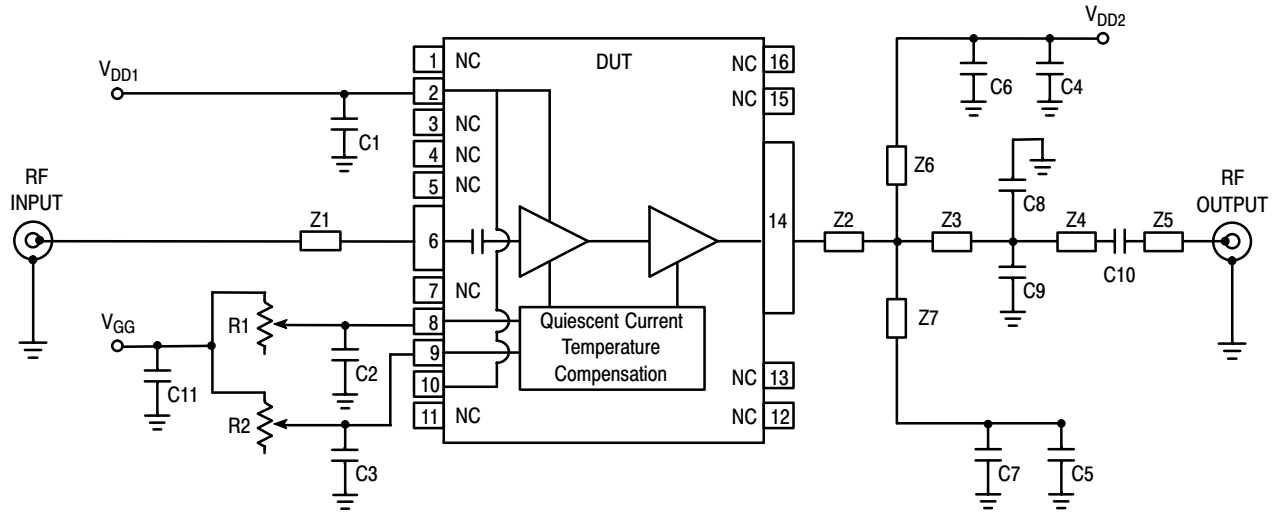

Figure 16. Series Equivalent Input and Load Impedance

Table 8. Common Source Scattering Parameters ($V_{DD} = 28\text{ V}$, $I_{DQ1} = 210\text{ mA}$, $I_{DQ2} = 370\text{ mA}$, 50 Ohm System)

f MHz	S ₁₁		S ₂₁		S ₁₂		S ₂₂	
	S ₁₁	∠ φ	S ₂₁	∠ φ	S ₁₂	∠ φ	S ₂₂	∠ φ
1000	0.788	131.360	0.0013	63.602	0.0020	25.353	0.9940	172.664
1200	0.713	113.326	0.0012	42.219	0.0094	10.742	0.9910	169.954
1400	0.584	86.885	0.0007	55.210	0.1180	-39.325	0.9850	166.452
1600	0.389	41.593	0.0006	117.726	0.6690	-92.822	0.9780	161.752
1800	0.239	-54.753	0.0022	122.409	4.9300	-164.584	0.9310	152.388
2000	0.221	-162.180	0.0036	118.178	21.396	49.432	0.6120	151.441
2200	0.216	-38.746	0.0057	68.626	19.739	-105.946	0.7530	-177.800
2400	0.467	-113.440	0.0043	64.758	7.8281	166.887	0.9010	171.868
2600	0.539	-153.020	0.0044	48.498	3.8868	113.310	0.9350	167.252
2800	0.635	-171.630	0.0044	52.829	2.4331	69.460	0.9480	164.137
3000	0.716	169.263	0.0049	56.398	1.6119	29.135	0.9570	161.593

TD-SCDMA CHARACTERIZATION



Z1	1.180" x 0.056" Microstrip	Z5	0.727" x 0.056" Microstrip
Z2	0.136" x 0.237" Microstrip	Z6, Z7	1.066" x 0.078" Microstrip
Z3	0.096" x 0.237" Microstrip	PCB	Taconic TLX8, 0.020", $\epsilon_r = 2.55$
Z4	0.181" x 0.237" Microstrip		

Figure 17. MW6IC2240NBR1(GNBR1) Test Circuit Schematic — TD-SCDMA

Table 9. MW6IC2240NBR1(GNBR1) Test Circuit Component Designations and Values — TD-SCDMA

Part	Description	Part Number	Manufacturer
C1, C4, C5, C11	2.2 μ F Chip Capacitors	C3225X5R1H225MT	TDK
C2, C3	100 nF Chip Capacitors	C1206CK104K5RC	Kemet
C8, C9	1.2 pF Chip Capacitors	08051J1R2BBS	AVX
C10	6.8 pF Chip Capacitor	08051J6R8CBS	AVX
C6, C7	5.6 pF Chip Capacitors	08051J5R6CBS	AVX
R1, R2	5 k Ω Potentiometer CMS Cermet Multi-turn	3224W	Bourns

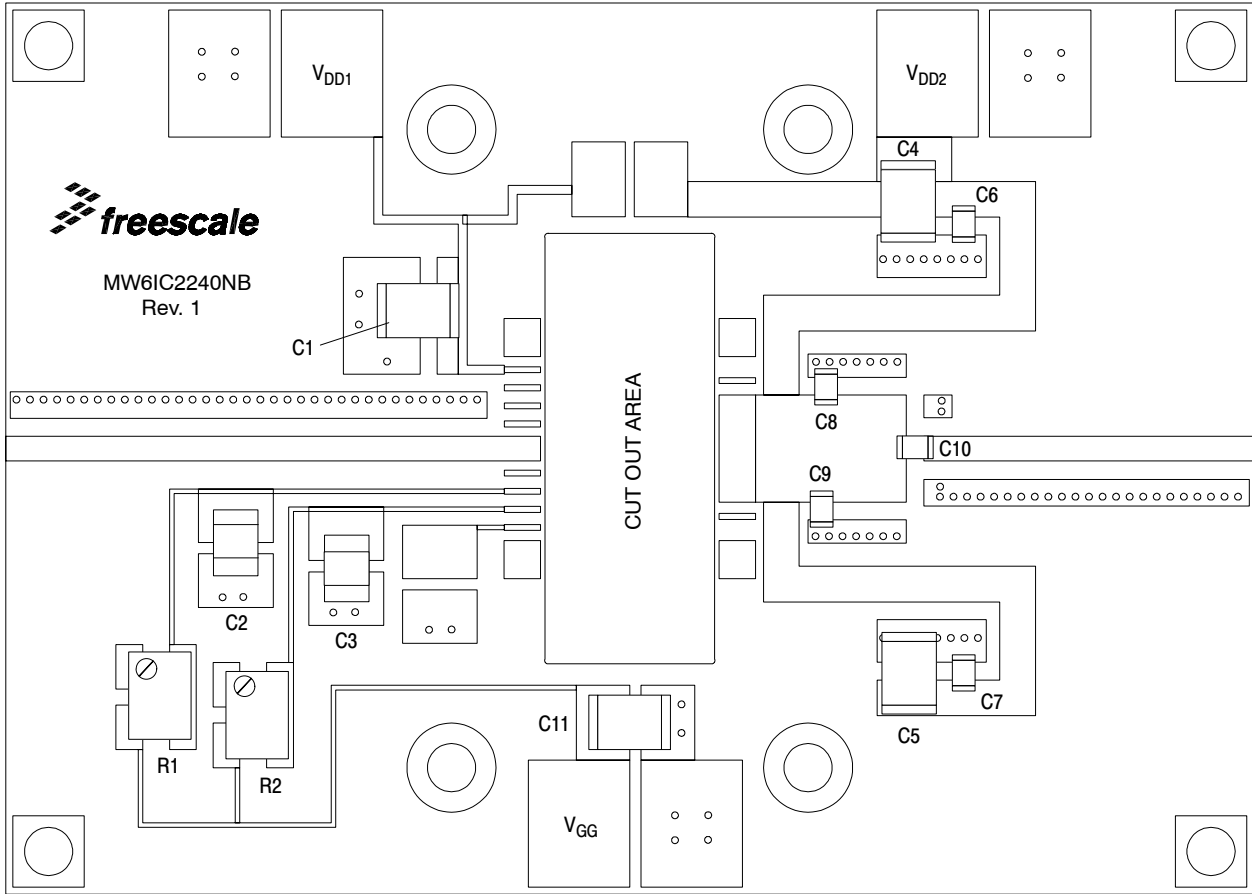

Figure 18. MW6IC2240NBR1(GNBR1) Test Circuit Component Layout — TD-SCDMA

TYPICAL CHARACTERISTICS

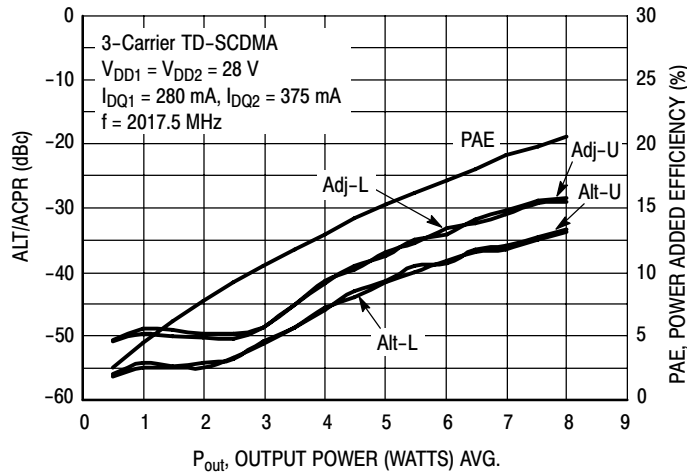

Figure 19. 3-Carrier TD-SCDMA ACPR, ALT and Power Added Efficiency versus Output Power

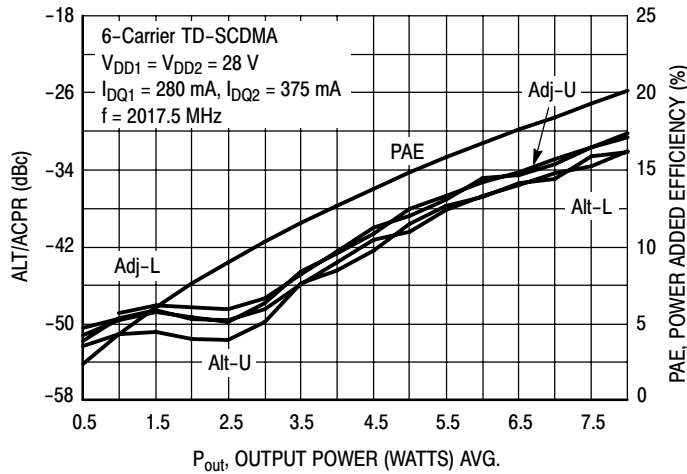

Figure 20. 6-Carrier TD-SCDMA ACPR, ALT and Power Added Efficiency versus Output Power

TD-SCDMA TEST SIGNAL

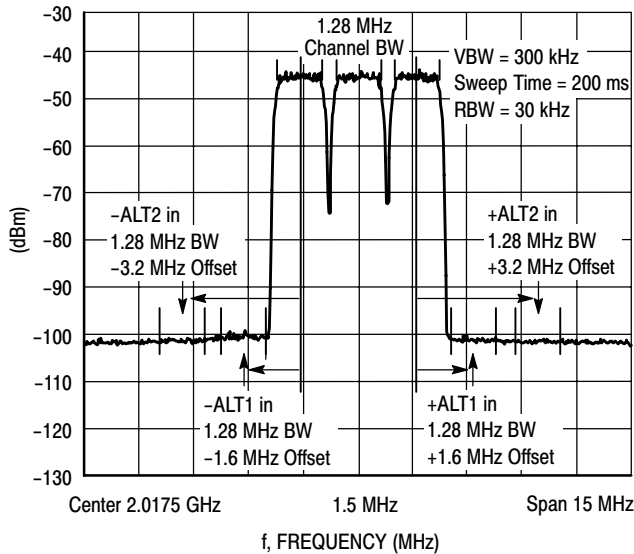

Figure 21. 3-Carrier TD-SCDMA Spectrum

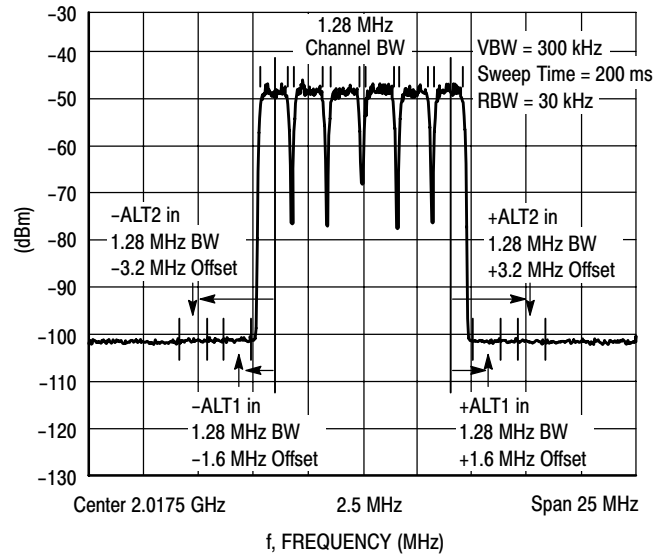
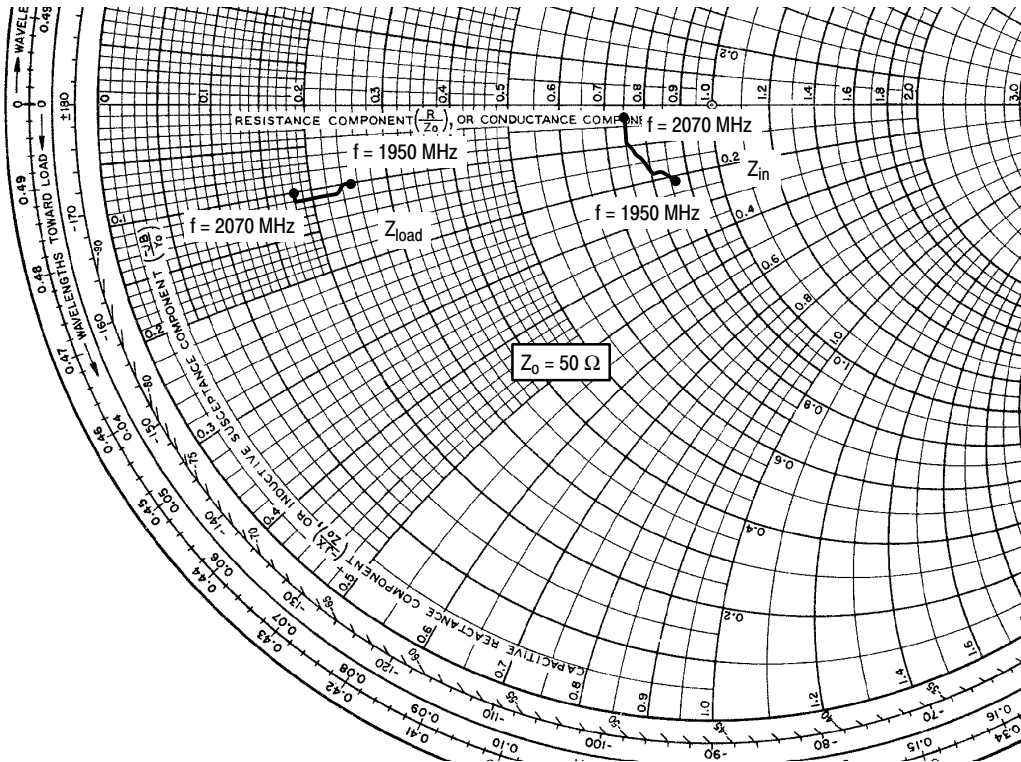

Figure 22. 6-Carrier TD-SCDMA Spectrum



$V_{DD} = 28 \text{ Vdc}$, $I_{DQ1} = 280 \text{ mA}$, $I_{DQ2} = 375 \text{ mA}$

f MHz	Z_{in} Ω	Z_{load} Ω
1950	42.975 - j10.510	12.419 - j4.771
1960	41.871 - j9.592	12.233 - j5.001
1970	40.898 - j9.050	11.983 - j5.104
1980	40.084 - j8.816	11.683 - j5.368
1990	39.463 - j7.496	11.334 - j5.499
2000	38.859 - j6.587	10.959 - j5.585
2010	38.434 - j6.117	10.578 - j5.631
2020	38.096 - j4.972	10.212 - j5.635
2030	37.748 - j4.486	9.877 - j5.596
2040	37.553 - j3.046	9.575 - j5.536
2050	37.414 - j2.586	9.302 - j5.439
2060	37.369 - j1.918	9.053 - j5.319
2070	37.420 - j1.654	8.831 - j5.185

Z_{in} = Device input impedance as measured from gate to ground.

Z_{load} = Test circuit impedance as measured from drain to ground.

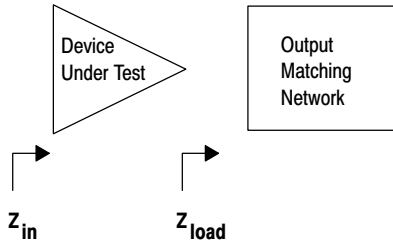
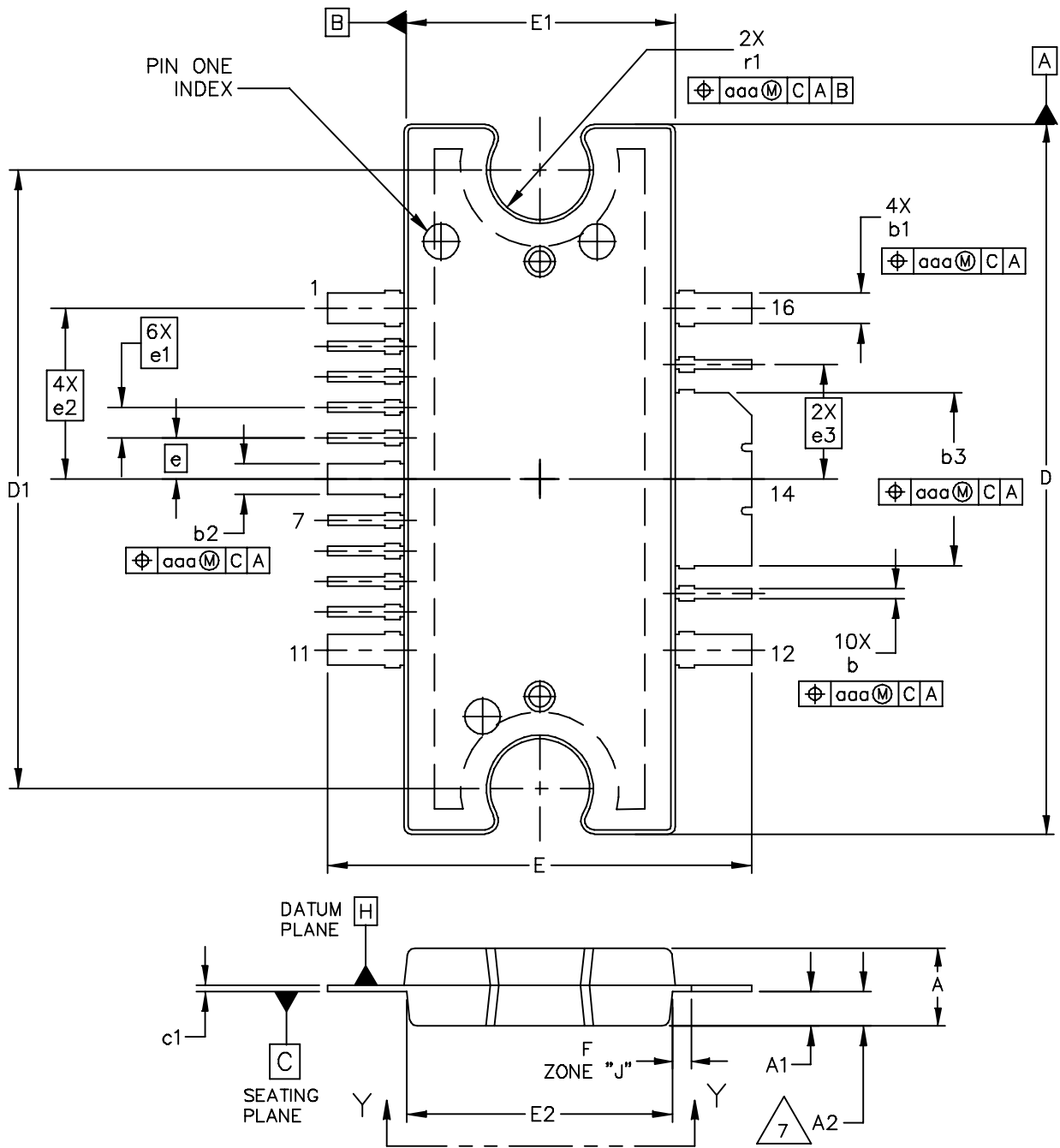
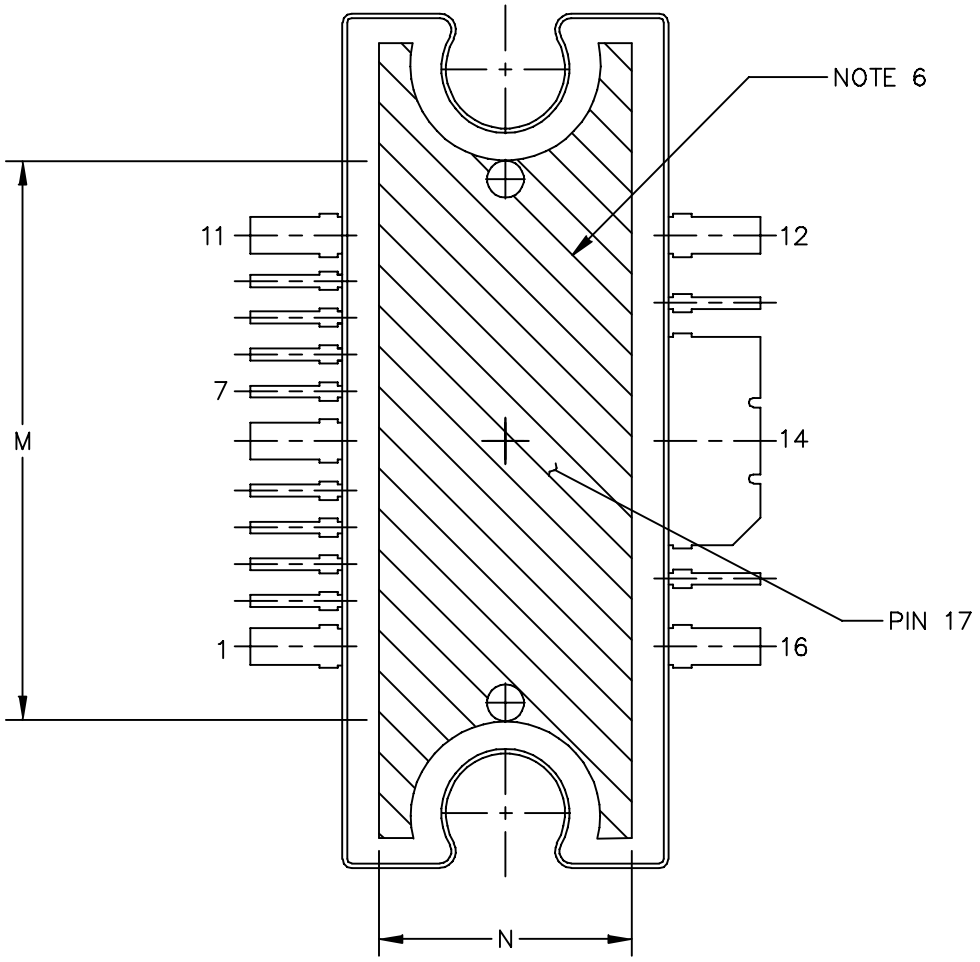

Figure 23. Series Equivalent Input and Load Impedance — TD-SCDMA

PACKAGE DIMENSIONS



© FREESCALE SEMICONDUCTOR, INC. ALL RIGHTS RESERVED.		MECHANICAL OUTLINE	PRINT VERSION NOT TO SCALE
TITLE: TO-272 WIDE BODY MULTI-LEAD		DOCUMENT NO: 98ARH99164A	REV: M
		CASE NUMBER: 1329-09	23 AUG 2007
		STANDARD: NON-JEDEC	



VIEW Y-Y

© FREESCALE SEMICONDUCTOR, INC. ALL RIGHTS RESERVED.	MECHANICAL OUTLINE	PRINT VERSION NOT TO SCALE	
TITLE: TO-272 WIDE BODY MULTI-LEAD	DOCUMENT NO: 98ARH99164A	REV: M	
	CASE NUMBER: 1329-09	23 AUG 2007	
	STANDARD: NON-JEDEC		

NOTES:

1. CONTROLLING DIMENSION: INCH
2. INTERPRET DIMENSIONS AND TOLERANCES PER ASME Y14.5M-1994.
3. DATUM PLANE -H- IS LOCATED AT THE TOP OF LEAD AND IS COINCIDENT WITH THE LEAD WHERE THE LEAD EXITS THE PLASTIC BODY AT THE TOP OF THE PARTING LINE.
4. DIMENSIONS "D" AND "E1" DO NOT INCLUDE MOLD PROTRUSION. ALLOWABLE PROTRUSION IS .006 (0.15) PER SIDE. DIMENSIONS "D" AND "E1" DO INCLUDE MOLD MISMATCH AND ARE DETERMINED AT DATUM PLANE -H-.
5. DIMENSIONS "b", "b1", "b2" AND "b3" DO NOT INCLUDE DAMBAR PROTRUSION. ALLOWABLE DAMBAR PROTRUSION SHALL BE .005 (0.13) TOTAL IN EXCESS OF THE "b", "b1", "b2" AND "b3" DIMENSIONS AT MAXIMUM MATERIAL CONDITION.
6. HATCHING REPRESENTS THE EXPOSED AREA OF THE HEAT SLUG. HATCHED AREA SHOWN IS ON THE SAME PLANE.
7. DIM A2 APPLIES WITHIN ZONE "J" ONLY.

DIM	INCH		MILLIMETER		DIM	INCH		MILLIMETER	
	MIN	MAX	MIN	MAX		MIN	MAX	MIN	MAX
A	.100	.104	2.54	2.64	b	.011	.017	0.28	0.43
A1	.038	.044	0.96	1.12	b1	.037	.043	0.94	1.09
A2	.040	.042	1.02	1.07	b2	.037	.043	0.94	1.09
D	.928	.932	23.57	23.67	b3	.225	.231	5.72	5.87
D1	.810 BSC		20.57 BSC		c1	.007	.011	.18	.28
E	.551	.559	14.00	14.20	e	.054 BSC		1.37 BSC	
E1	.353	.357	8.97	9.07	e1	.040 BSC		1.02 BSC	
E2	.346	.350	8.79	8.89	e2	.224 BSC		5.69 BSC	
F	.025 BSC		0.64 BSC		e3	.150 BSC		3.81 BSC	
M	.600	----	15.24	----	r1	.063	.068	1.6	1.73
N	.270	----	6.86	----	aaa	.004		.10	
© FREESCALE SEMICONDUCTOR, INC. ALL RIGHTS RESERVED.			MECHANICAL OUTLINE			PRINT VERSION NOT TO SCALE			
TITLE: TO-272 WIDE BODY MULTI-LEAD					DOCUMENT NO: 98ARH99164A			REV: M	
					CASE NUMBER: 1329-09			23 AUG 2007	
					STANDARD: NON-JEDEC				

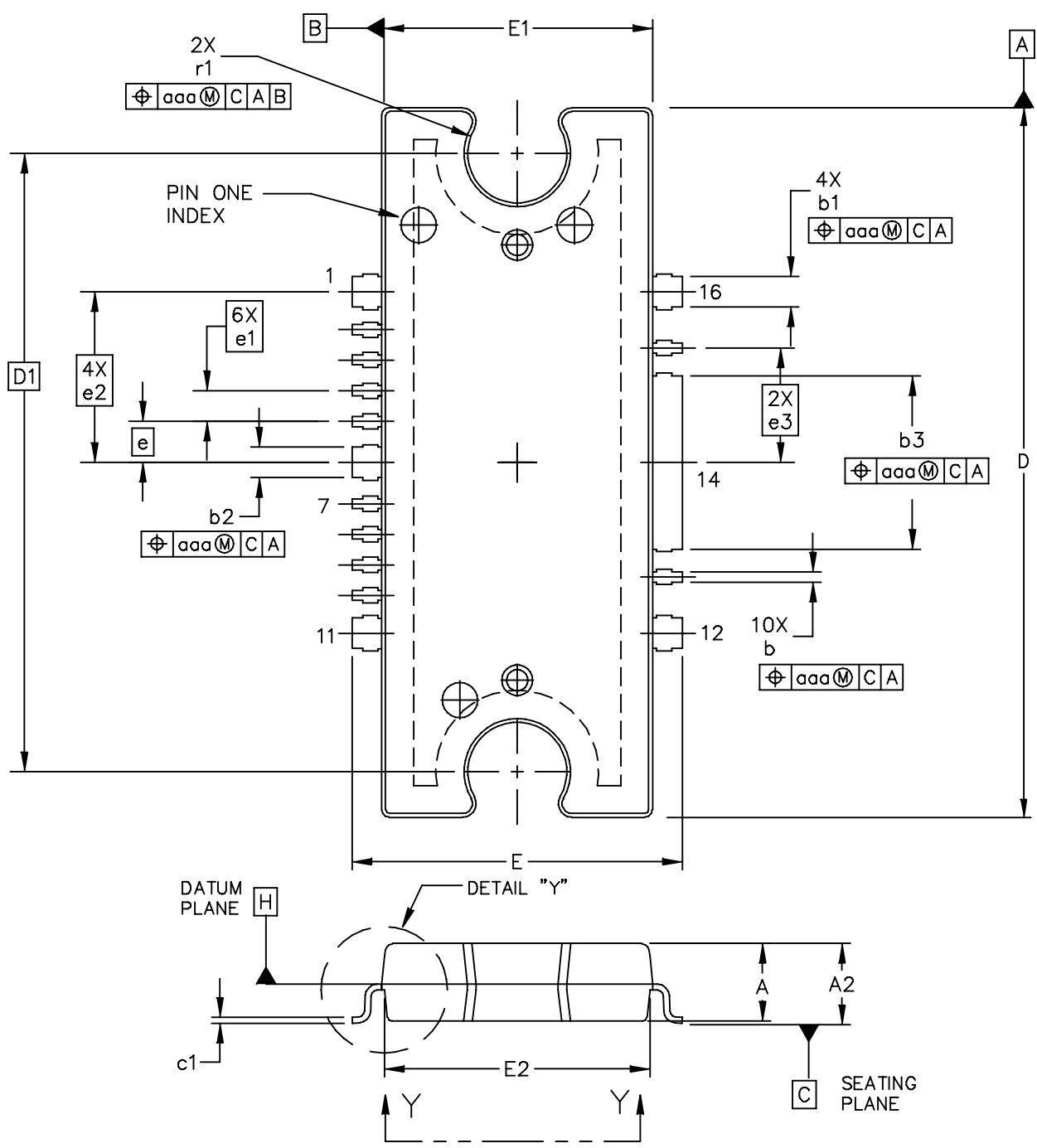

© FREESCALE SEMICONDUCTOR, INC. ALL RIGHTS RESERVED.		MECHANICAL OUTLINE	PRINT VERSION NOT TO SCALE
TITLE: TO-272WB, 16 LEAD GULL WING PLASTIC		DOCUMENT NO: 98ASA10532D	REV: F
		CASE NUMBER: 1329A-04	20 JUN 2007
		STANDARD: JEDEC MO-253 BA	

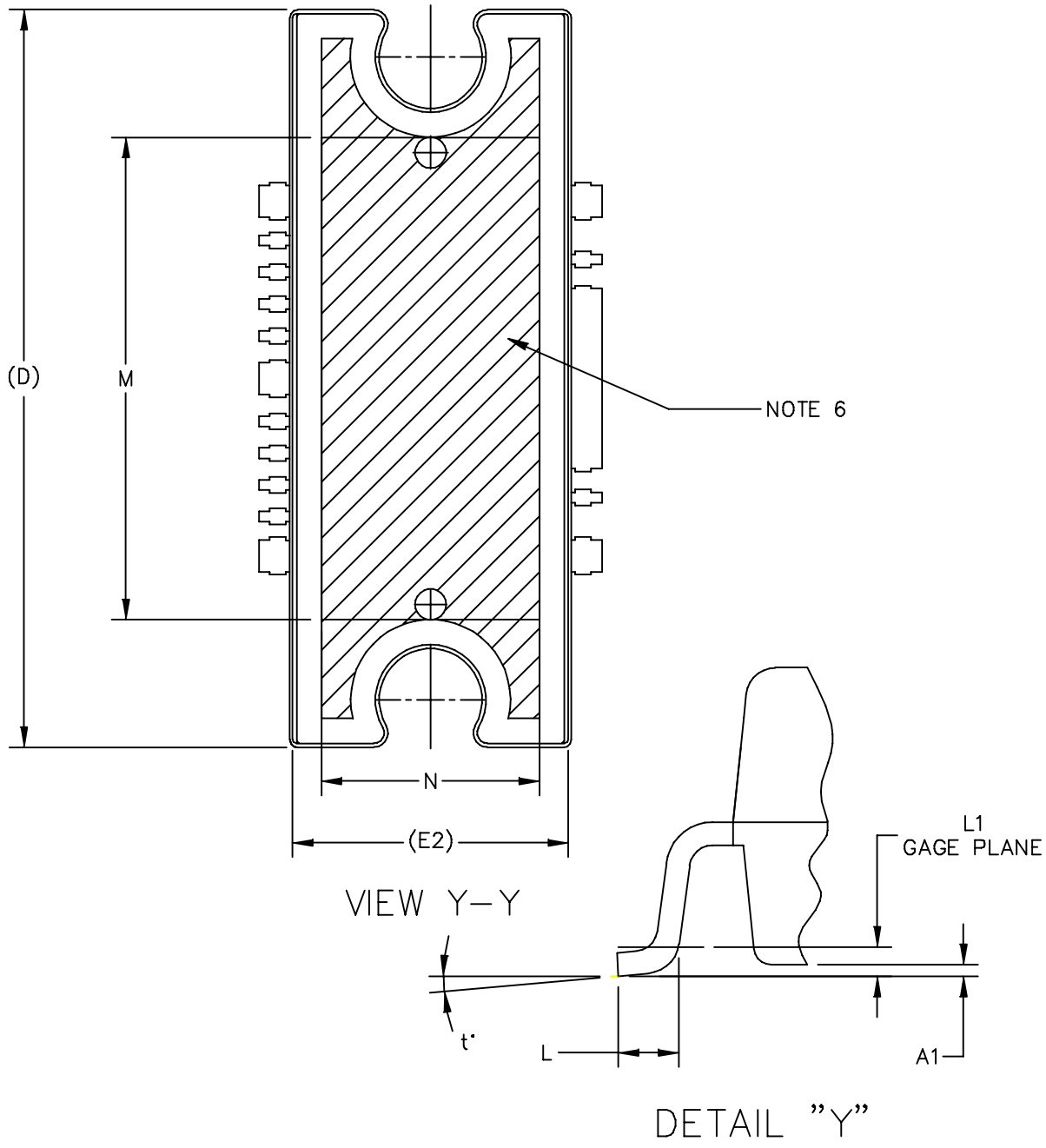

© FREESCALE SEMICONDUCTOR, INC. ALL RIGHTS RESERVED.	MECHANICAL OUTLINE	PRINT VERSION NOT TO SCALE	
TITLE: TO-272WB, 16 LEAD GULL WING PLASTIC	DOCUMENT NO: 98ASA10532D	REV: F	
	CASE NUMBER: 1329A-04	20 JUN 2007	
	STANDARD: JEDEC MO-253 BA		

NOTES:

1. CONTROLLING DIMENSION: INCH
2. INTERPRET DIMENSIONS AND TOLERANCES PER ASME Y14.5M-1994.
3. DATUM PLANE -H- IS LOCATED AT THE TOP OF LEAD AND IS COINCIDENT WITH THE LEAD WHERE THE LEAD EXITS THE PLASTIC BODY AT THE TOP OF THE PARTING LINE.
4. DIMENSIONS "D" AND "E1" DO NOT INCLUDE MOLD PROTRUSION. ALLOWABLE PROTRUSION IS .006 (0.15) PER SIDE. DIMENSIONS "D" AND "E1" DO INCLUDE MOLD MISMATCH AND ARE DETERMINED AT DATUM PLANE -H-.
5. DIMENSIONS "b", "b1", "b2" AND "b3" DO NOT INCLUDE DAMBAR PROTRUSION. ALLOWABLE DAMBAR PROTRUSION SHALL BE .005 (0.13) TOTAL IN EXCESS OF THE "b", "b1", "b2" AND "b3" DIMENSIONS AT MAXIMUM MATERIAL CONDITION.
6. HATCHING REPRESENTS EXPOSED AREA OF THE HEAT SLUG. HATCHED AREA SHOWN IS ON THE SAME PLANE.

DIM	INCH		MILLIMETER		DIM	INCH		MILLIMETER	
	MIN	MAX	MIN	MAX		MIN	MAX	MIN	MAX
A	.100	.104	2.54	2.64	b	.011	.017	0.28	0.43
A1	.001	.004	0.02	0.10	b1	.037	.043	0.94	1.09
A2	.099	.110	2.51	2.79	b2	.037	.043	0.94	1.09
D	.928	.932	23.57	23.67	b3	.225	.231	5.72	5.87
D1	.810 BSC		20.57 BSC		c1	.007	.011	.18	.28
E	.429	.437	10.9	11.1	e	.054 BSC		1.37 BSC	
E1	.353	.357	8.97	9.07	e1	.040 BSC		1.02 BSC	
E2	.346	.350	8.79	8.89	e2	.224 BSC		5.69 BSC	
L	.018	.024	0.46	0.61	e3	.150 BSC		3.81 BSC	
L1	.01 BSC		0.25 BSC		r1	.063	.068	1.6	1.73
M	.600	----	15.24	----	t	2'	8'	2'	8'
N	.270	----	6.86	----	aaa	.004		.10	
© FREESCALE SEMICONDUCTOR, INC. ALL RIGHTS RESERVED.			MECHANICAL OUTLINE			PRINT VERSION NOT TO SCALE			
TITLE: TO-272 WB 16 LEAD GULL WING PLASTIC					DOCUMENT NO: 98ASA10532D			REV: F	
					CASE NUMBER: 1329A-04			20 JUN 2007	
					STANDARD: JEDEC MO-253 BA				

PRODUCT DOCUMENTATION

Refer to the following documents to aid your design process.

Application Notes

- AN1907: Solder Reflow Attach Method for High Power RF Devices in Plastic Packages
- AN1955: Thermal Measurement Methodology of RF Power Amplifiers
- AN1977: Quiescent Current Thermal Tracking Circuit in the RF Integrated Circuit Family
- AN1987: Quiescent Current Control for the RF Integrated Circuit Device Family
- AN3263: Bolt Down Mounting Method for High Power RF Transistors and RFICs in Over-Molded Plastic Packages

Engineering Bulletins

- EB212: Using Data Sheet Impedances for RF LDMOS Devices

REVISION HISTORY

The following table summarizes revisions to this document.

Revision	Date	Description
3	Oct. 2006	<ul style="list-style-type: none"> • Added "including TD-SCDMA" to data sheet description, p. 1 • Added Part Number and Manufacturer to Resistors in Table 7, Component Designations and Values, p. 4 • Added TD-SCDMA test circuit schematic, component designations and values, component layout, typical characteristic curves, test signal and series impedance, p. 11 - 14 • Added Product Documentation and Revision History, p. 21
4	Dec. 2006	<ul style="list-style-type: none"> • Updated Part Numbers in Table 7, Component Designations and Values, to RoHS compliant part numbers, p. 4
5	Feb. 2007	<ul style="list-style-type: none"> • Corrected V_{BIAS} and V_{SUPPLY} callouts, Fig. 3, Test Circuit Schematic, p. 4, Fig. 4, Test Circuit Component Layout, p. 5 • Updated Part Numbers in Tables 7 and 9, Component Designations and Values, to latest RoHS compliant part numbers, p. 4, 11 • Removed lower voltage tests from Fig. 14, Power Gain versus Output Power, due to fixed tuned fixture limitations, p. 8 • Replaced Fig. 15, MTTF versus Junction Temperature with updated graph. Removed Amps² and listed operating characteristics and location of MTTF calculator for device, p. 8 • Changed callout η_D to PAE (Power Added Efficiency) for Figs. 19 and 20, 3-Carrier and 6-Carrier TD-SCDMA ACPR, ALT and Power Added Efficiency versus Output Power, p. 13 • Corrected Z_{in} data and plot in Fig. 23, Series Impedance, p. 14
6	Dec. 2008	<ul style="list-style-type: none"> • Modified data sheet to reflect RF Test Reduction described in Product and Process Change Notification number, PCN13232, p. 1, 2 • Changed 220°C to 225°C in Capable Plastic Package bullet, p. 1 • Added Footnote 1 to Quiescent Current Temperature bullet under Features section and to callout in Figure 1, Functional Block Diagram, p. 1 • Changed Storage Temperature Range in Max Ratings table from -65 to +200 to -65 to +150 for standardization across products, p. 2 • Added Case Operating Temperature limit to the Maximum Ratings table and set limit to 150°C, p. 2 • Operating Junction Temperature increased from 200°C to 225°C in Maximum Ratings table and related "Continuous use at maximum temperature will affect MTTF" footnote added, p. 2 • Updated Part Numbers in Table 7, Component Designations and Values, to latest RoHS compliant part numbers, p. 4

How to Reach Us:

Home Page:

www.freescale.com

Web Support:

<http://www.freescale.com/support>

USA/Europe or Locations Not Listed:

Freescale Semiconductor, Inc.
Technical Information Center, EL516
2100 East Elliot Road
Tempe, Arizona 85284
1-800-521-6274 or +1-480-768-2130
www.freescale.com/support

Europe, Middle East, and Africa:

Freescale Halbleiter Deutschland GmbH
Technical Information Center
Schatzbogen 7
81829 Muenchen, Germany
+44 1296 380 456 (English)
+46 8 52200080 (English)
+49 89 92103 559 (German)
+33 1 69 35 48 48 (French)
www.freescale.com/support

Japan:

Freescale Semiconductor Japan Ltd.
Headquarters
ARCO Tower 15F
1-8-1, Shimo-Meguro, Meguro-ku,
Tokyo 153-0064
Japan
0120 191014 or +81 3 5437 9125
support.japan@freescale.com

Asia/Pacific:

Freescale Semiconductor China Ltd.
Exchange Building 23F
No. 118 Jianguo Road
Chaoyang District
Beijing 100022
China
+86 10 5879 8000
support.asia@freescale.com

For Literature Requests Only:

Freescale Semiconductor Literature Distribution Center
P.O. Box 5405
Denver, Colorado 80217
1-800-441-2447 or +1-303-675-2140
Fax: +1-303-675-2150
LDCForFreescaleSemiconductor@hibbertgroup.com

Information in this document is provided solely to enable system and software implementers to use Freescale Semiconductor products. There are no express or implied copyright licenses granted hereunder to design or fabricate any integrated circuits or integrated circuits based on the information in this document.

Freescale Semiconductor reserves the right to make changes without further notice to any products herein. Freescale Semiconductor makes no warranty, representation or guarantee regarding the suitability of its products for any particular purpose, nor does Freescale Semiconductor assume any liability arising out of the application or use of any product or circuit, and specifically disclaims any and all liability, including without limitation consequential or incidental damages. "Typical" parameters that may be provided in Freescale Semiconductor data sheets and/or specifications can and do vary in different applications and actual performance may vary over time. All operating parameters, including "Typicals", must be validated for each customer application by customer's technical experts. Freescale Semiconductor does not convey any license under its patent rights nor the rights of others. Freescale Semiconductor products are not designed, intended, or authorized for use as components in systems intended for surgical implant into the body, or other applications intended to support or sustain life, or for any other application in which the failure of the Freescale Semiconductor product could create a situation where personal injury or death may occur. Should Buyer purchase or use Freescale Semiconductor products for any such unintended or unauthorized application, Buyer shall indemnify and hold Freescale Semiconductor and its officers, employees, subsidiaries, affiliates, and distributors harmless against all claims, costs, damages, and expenses, and reasonable attorney fees arising out of, directly or indirectly, any claim of personal injury or death associated with such unintended or unauthorized use, even if such claim alleges that Freescale Semiconductor was negligent regarding the design or manufacture of the part.

Freescale™ and the Freescale logo are trademarks of Freescale Semiconductor, Inc. All other product or service names are the property of their respective owners.

© Freescale Semiconductor, Inc. 2005-2008. All rights reserved.