

"AE" Series Washable Rockers/Paddles The Gemini Series

FUNCTIONS

The following functions available in SP or DP.

- 01** 2 Positions None indicates no mechanical position
- 03** 3 Positions
- 05** 3 Positions Off indicates a mechanical position with no electrical connection.
- 07** 3 Positions
- 08** 2 Positions (On) indicates momentary action.

SPDT, connect terminals:

DPDT, connect terminals:

- 11** 3 Positions
- 13** 3 Positions
- 15** 3 Positions

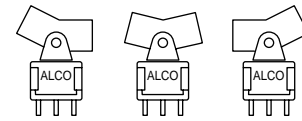

On None On

On Off On

(On) Off (On)

(On) Off On

(On) None On

1—2 — 2—3

1—2 — 2—3
4—5 — 5—6

On On On

(On) On On

(On) On (On)

1—2 2—3 2—3
4—5 4—5 5—6

Functions available in DP only: Connect terminals:

SP3T Available in DP Format Only

Wiring Diagrams for Functions

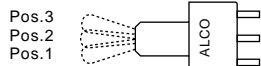

11 **13** **15**

SINGLE POLE 3 POSITION

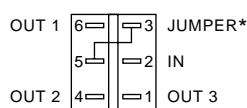

SP3T function achieved with external jumpers.

* Installed by Customer

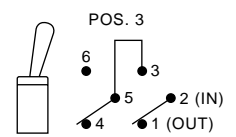
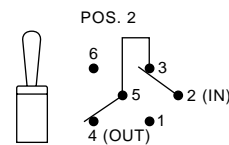
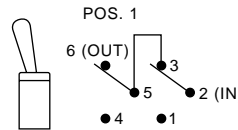

J1 Rocker

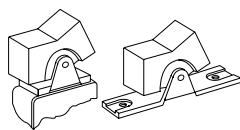

Use beveled frame B200 for enhancement (Pg. E12) when ordering with terminations other than C or Z.

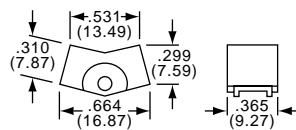

Unless otherwise specified by terminal type, the panel mounting bracket will be supplied.

Use beveled frame B100 for enhancement (Pg. E12) when ordering with terminations other than C or Z.

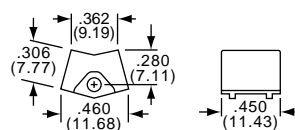

Unless otherwise specified by terminal type, the panel mounting bracket will be supplied.

ACTUATORS

J50

Rocker

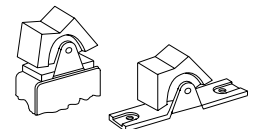

J2 Paddle

Paddle

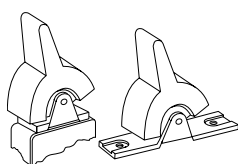

Use beveled frame B100 for enhancement (Pg. E12) when ordering with terminations other than C or Z.

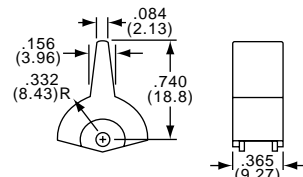

Unless otherwise specified by terminal type, the panel mounting bracket will be supplied.

Use beveled frame B200 for enhancement (Pg. E12) when ordering with terminations other than C or Z.

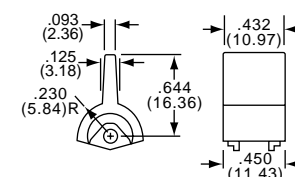

Unless otherwise specified by terminal type, the panel mounting bracket will be supplied.

J60

Paddle

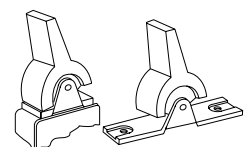

Need more technical information?

Consult your local Augat sales office listed on the back cover

AUGAT Inc.
452 John L. Dietsch Blvd.
Attleboro Falls, MA 02763 USA
(508) 699-9800 FAX (800) 533-2526

The Gemini Series "AE" Series Washable Rockers/Paddles

TERMINALS

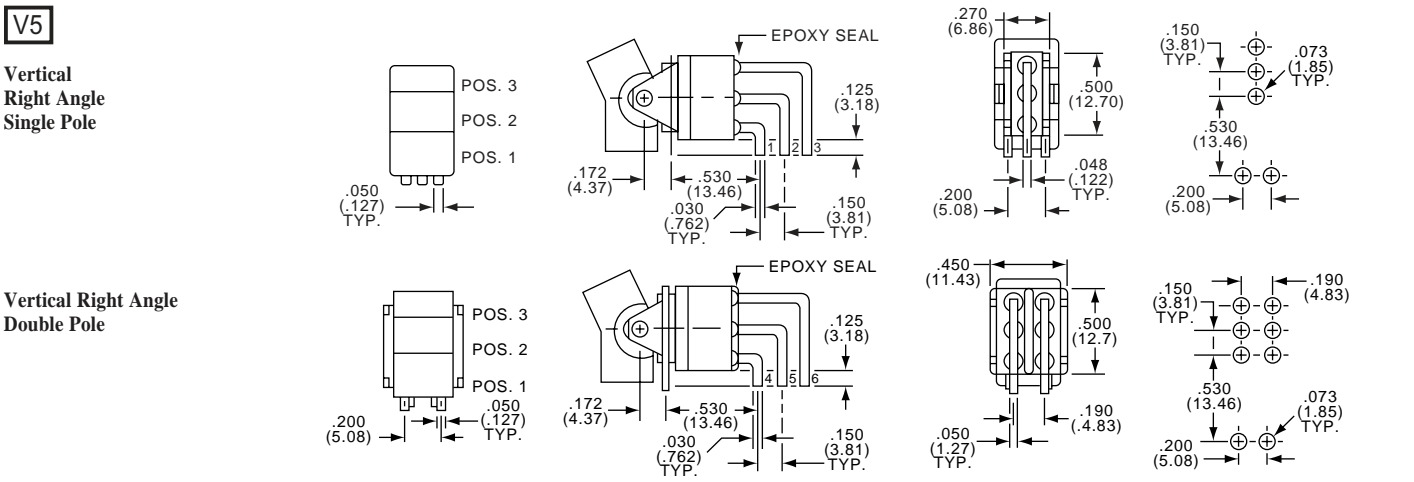
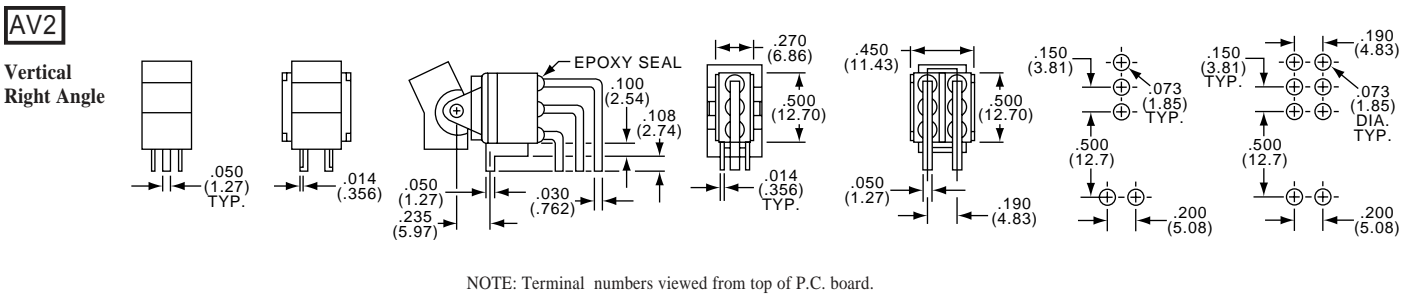
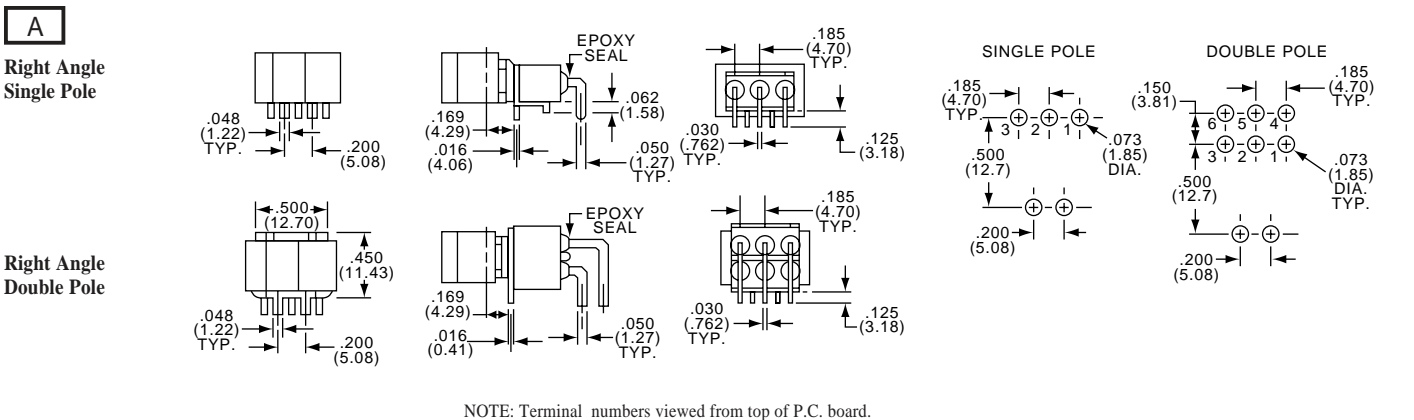
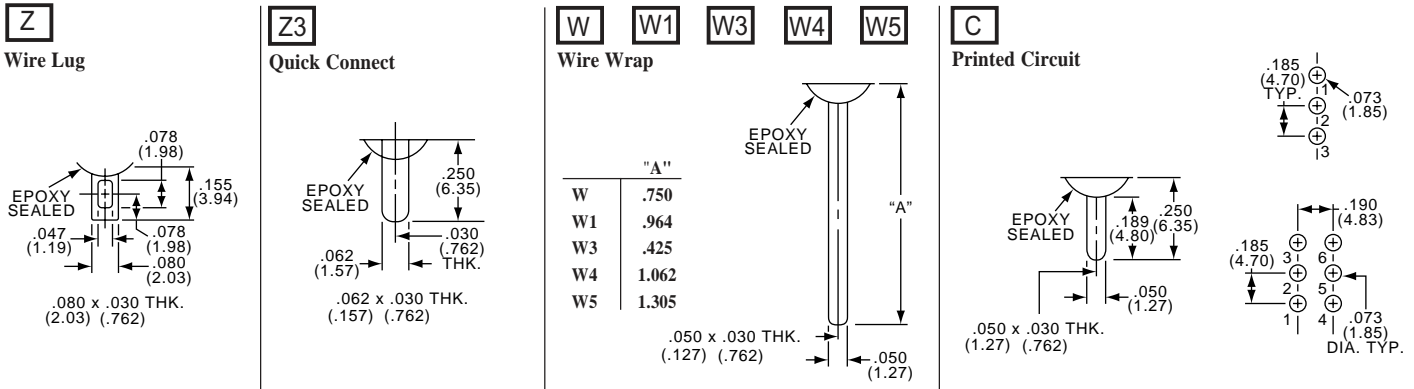

"AE" Series Washable Rockers/Paddles The Gemini Series

V3 V4 V9

Vertical Support Bracket
Single Pole

Option Code	Dim. "A"
V3	.460 (11.68)
V4	.630 (16.00)
V9	1.150 (29.21)

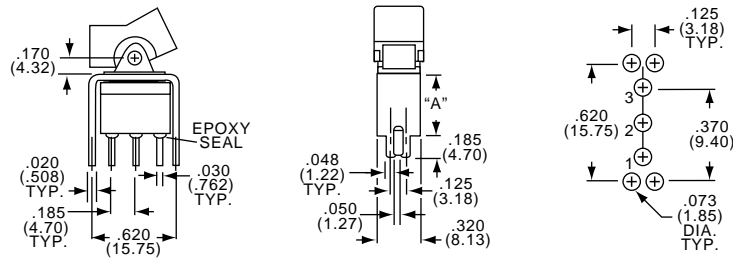

Vertical Support Bracket
Double Pole

Option Code	Dim. "A"
V3	.460 (11.68)
V4	.630 (16.00)
V9	1.150 (29.21)

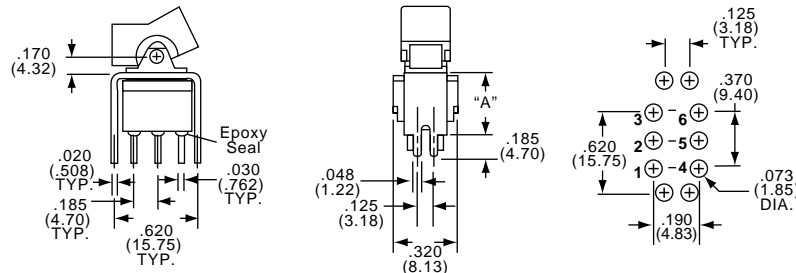

V6 V7 V8

Vertical Support Bracket
Single Pole

Option Code	Dim. "A"
V6	.460 (11.68)
V7	.630 (16.00)
V8	.953 (24.21)

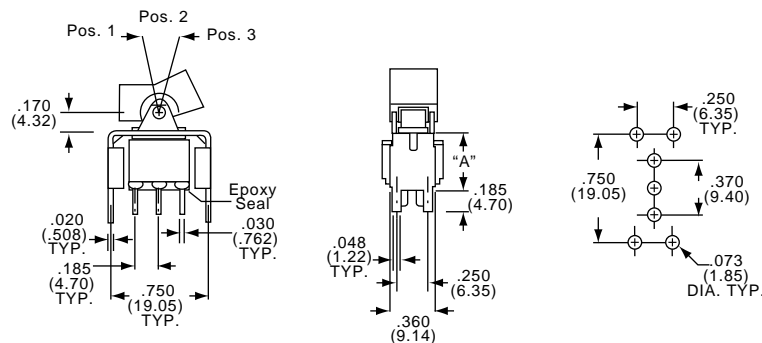

Vertical Support Bracket
Double Pole

Option Code	Dim. "A"
V6	.460 (11.68)
V7	.630 (16.00)
V8	.953 (24.21)

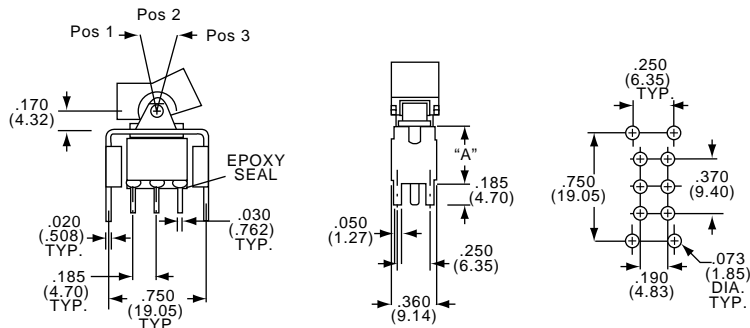

CONTACTS

B CONTACTS: Copper alloy with gold plate, welded button.

TERMINALS: Copper alloy with gold plate.

ELECTRICAL RATING: 0.4VA @ 20 VAC/DC.

Q CONTACTS: Copper alloy with silver, welded button.

TERMINALS: Copper alloy with tin/lead plate.

ELECTRICAL RATING: 5 amps @ 125 VAC, 2 amps @ 250 VAC, 5 amps @ 28 VDC.

UL/CSA RATING: 5A @ 125 VAC, 3 @ 250 VAC (Specify "UL" option code)

G CONTACTS: Copper alloy with gold plate over silver, welded button.

TERMINALS: Copper alloy with gold plate.
ELECTRICAL RATING: 0.4 VA @ 20 VAC/DC or 5 amps @ 125 VAC, 2 amps @ 250 VAC, 5 amps @ 28 VDC.

Note: This contact option can be used for low-level or power switching. If level is above 0.4 VA @ 20 VAC/DC, the switch is rendered usable only for power switching due to arc-removal of gold plate.

UL/CSA RATING: 5A @ 125 VAC, 3 @ 250 VAC (Specify "UL" option code)

Need more technical information?

Consult your local Augat sales office listed on the back cover