

**Pb** THIS PRODUCT MANUFACTURED WITH LEAD-FREE PROCESSING

**DESIGNED & DIMENSIONED IN MILLIMETERS(INCHES)**

DO NOT SCALE FROM THIS PRINT

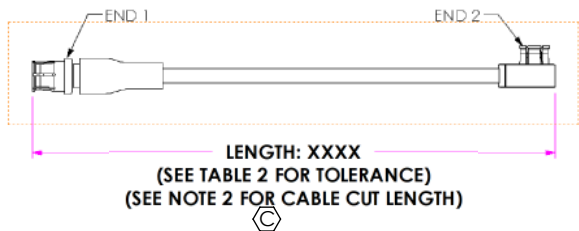
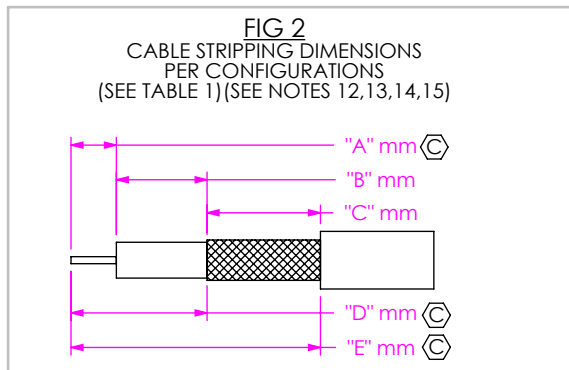
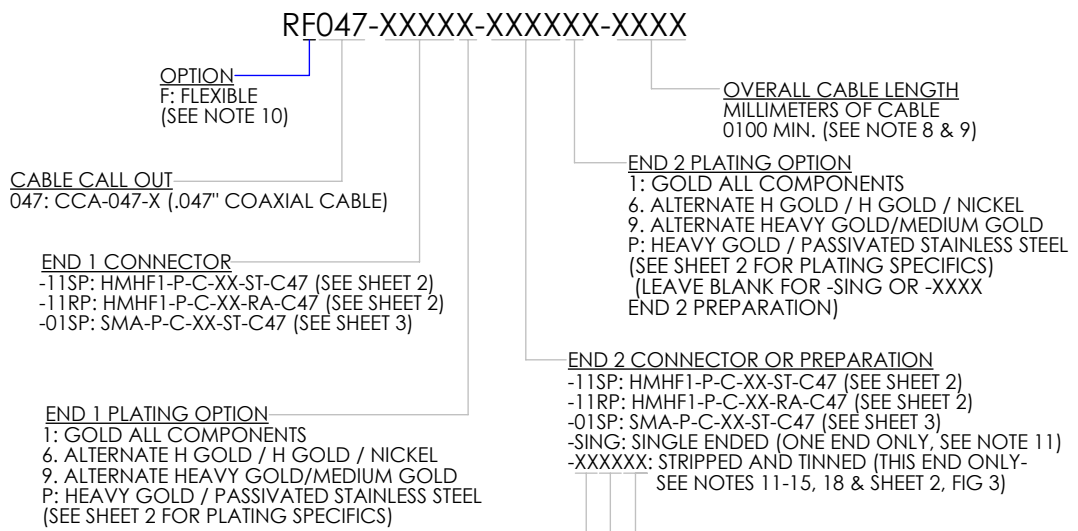

FIG 1  
RX047-11SPX-11RPX-XXXX SHOWN



DO NOT LEAVE ANY SPACE BLANK, EACH MUST CONTAIN A NUMERIC CHARACTER 0 THRU 9.

NOTES:

1. Ⓢ REPRESENTS A CRITICAL DIMENSION.
2. CABLE CUT LENGTH:  
= (LENGTH: XXXX) - (SUBTRACTOR FOR END 1) - (SUBTRACTOR FOR END 2).  
(SEE TABLE 1 FOR SUBTRACTORS)
3. ASSEMBLY TO BE 100% TESTED FOR OPENS & SHORTS.
4. ASSEMBLY TO BE 100% HI-POT TESTED PER TABLE 1, THE TEST VOLTAGE FOR THE ASSEMBLY SHOULD BE SET TO THE END OPTION WITH THE LOWEST TEST VOLTAGE RATING.
5. AFTER FINAL ELECTRICAL TESTS, LABEL EACH CABLE ASSEMBLY WITH 1 LABEL -ET
6. CRITICALS ON CONNECTOR PRINTS TO BE CHECKED IN PROCESS.
7. FINISHED ASSEMBLIES TO BE PACKAGED PER PACKAGING STANDARD CO-HD-WI-3040-M. ASSEMBLIES WITH LOCKWASHERS, NUTS, AND GASKETS TO BE SHIPPED KITTED AS ONE ASSEMBLY PER BAG, UNASSEMBLED.
8. CABLE STOCKED IN INCHES, 1 INCH = 25.4 MILLIMETERS.
9. CABLE LENGTHS LONGER THAN 1000 MILLIMETERS ARE NOT SUPPORTED BY S.I. TEST DATA.
10. MINIMUM BEND RADIUS FOR RX047 = 5.00 [1.96].
11. FOR SING ENDED OR STRIPPED AND TINNED ASSEMBLIES: MAKE A DOUBLE ENDED ASSEMBLY AT TWICE THE CABLE LENGTH AND TEST BEFORE CUTTING ASSEMBLY IN HALF.
12. DIM "A" AND "B" HAVE A MINIMUM VALUE OF 0.0mm & A MAXIMUM VALUE OF 9.9mm.
13. PRODUCTION OF STRIP AND TIN FOR CENTER DIELECTIC USE: A.
14. PRODUCTION OF STRIP AND TIN FOR SHIELD USE: D=A+B.
15. PRODUCTION OF STRIP AND TIN FOR JACKET USE: E=A+B+C.
16. CONNECTORS TO BE ORIENTED ACCORDING TO CO-HD-WI-3048-M.
17. FOR BULKHEAD APPLICATIONS, THE END USER SHOULD TIGHTEN THE THREADED NUT TO 15 IN-LB MINIMUM.
18. FOR STRIPPED AND TINNED OPTION, ONLY THE CENTER CONDUCTOR IS TINNED.

F:\DWG\MISC\MKTG\RF047-XXXXX-XXXXX-XXXX-MKT.SLDDRW

<p><b>UNLESS OTHERWISE SPECIFIED, DIMENSIONS ARE IN MILLIMETERS (INCHES).</b></p> <p><b>TOLERANCES ARE:</b></p> <table border="0"> <tr> <td>DECIMALS</td> <td>ANGLES</td> </tr> <tr> <td>.X: ±0.3 [.01]</td> <td>5°</td> </tr> <tr> <td>.XX: ±0.13 [.005]</td> <td></td> </tr> <tr> <td>.XXX: ±0.051 [.0020]</td> <td></td> </tr> </table>	DECIMALS	ANGLES	.X: ±0.3 [.01]	5°	.XX: ±0.13 [.005]		.XXX: ±0.051 [.0020]		<p><b>PROPRIETARY NOTE</b></p> <p>THIS DOCUMENT CONTAINS CONFIDENTIAL AND PROPRIETARY INFORMATION AND ALL DESIGN, MANUFACTURING, REPRODUCTION, USE, PATENT RIGHTS AND SALES RIGHTS ARE EXPRESSLY RESERVED BY SAMTEC, INC. THIS DOCUMENT SHALL NOT BE DISCLOSED, IN WHOLE OR PART, TO ANY UNAUTHORIZED PERSON OR ENTITY NOR REPRODUCED, TRANSFERRED OR INCORPORATED IN ANY OTHER PROJECT IN ANY MANNER WITHOUT THE EXPRESS WRITTEN CONSENT OF SAMTEC, INC.</p>	<p><b>DESCRIPTION:</b> .047" CABLE ASSEMBLY</p>	
	DECIMALS	ANGLES									
.X: ±0.3 [.01]	5°										
.XX: ±0.13 [.005]											
.XXX: ±0.051 [.0020]											
<p><b>MATERIAL:</b> DO NOT SCALE DRAWING SHEET SCALE: 2:1</p> <p>SEE END 1 AND END 2 ASSEMBLY PRINTS</p>	<p><b>DWG. NO.</b> RF047-XXXXX-XXXXX-XXXX</p> <p><b>BY:</b> EMMA CHEN 3/20/2013 SHEET 1 OF 3</p>										

TABLE 1		
CABLE STYLE	CABLE CUT LENGTH	HI-POT
	SUBTRACTOR	DCV
-11SPX	2.0 [0.08]	500
-11RPX	1.5 [0.06]	500
-01SPX	0.9 [0.04]	500
-SING	0.0 [0.00]	500
-XXXXXX	0.0 [0.00]	500

TABLE 2: FINAL ASSEMBLY LENGTH TOLERANCE	
LENGTH	TOLERANCE
0100-0200 [3.92-7.87]	+3.0 [.12]/-0.0 [.00]
0200-0500 [7.87-19.69]	+5.0 [.20]/-0.0 [.00]
0500-1100 [19.69-43.30]	+10.0 [.40]/-0.0 [.00]
>1100 [43.30]	± 1%

FIG 3  
RX047-11SPX-2025-XXXX SHOWN

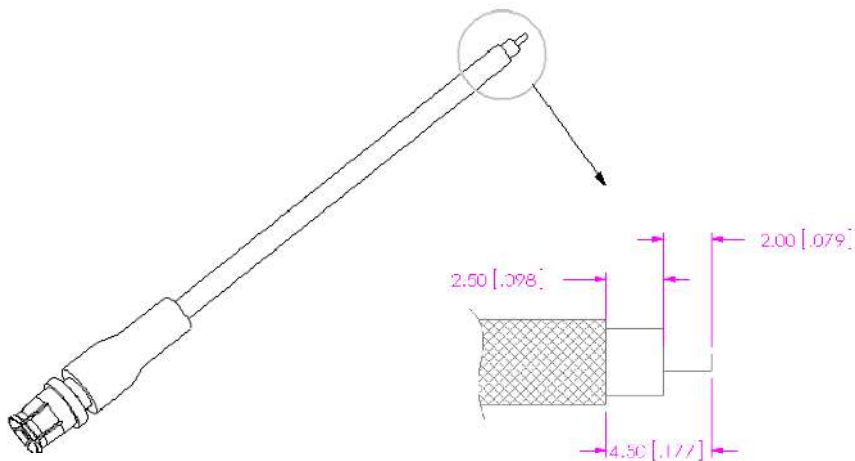

-11SP  
(STRAIGHT PLUG)

(USE DRAWING No. HMHF1-P-C-XX-ST-C47 FOR ASSEMBLY INSTRUCTIONS)

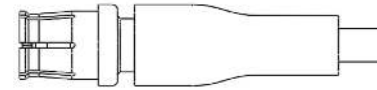

PLATING

9: 30μ" MIN. GOLD CENTER CONTACT  
10μ" MIN. GOLD OUTER CONTACT  
3μ" MIN. GOLD REMAINING METAL PARTS  
(END CONNECTOR P/N: HMHF1-P-C-HG-ST-C47)

NOTE: ALL CRITICAL DIMENSIONS ON HMHF1-P-C-XX-ST-C47 THAT APPLY MUST BE VERIFIED.

-11RP  
(RIGHT ANGLE PLUG)

(USE DRAWING No. HMHF1-P-C-XX-RA-C47 FOR ASSEMBLY INSTRUCTIONS)

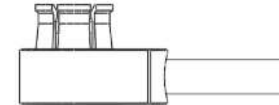

PLATING

9: 30μ" MIN. GOLD CENTER CONTACT  
10μ" MIN. GOLD OUTER CONTACT  
3μ" MIN. GOLD REMAINING METAL PARTS  
(END CONNECTOR P/N: HMHF1-P-C-HG-RA-C47)

NOTE: ALL CRITICAL DIMENSIONS ON HMHF1-P-C-XX-RA-C47 THAT APPLY MUST BE VERIFIED.

PROPRIETARY NOTE

THIS DOCUMENT CONTAINS CONFIDENTIAL AND PROPRIETARY INFORMATION AND ALL DESIGN, MANUFACTURING, REPRODUCTION, USE, PATENT RIGHTS AND SALES RIGHTS ARE EXPRESSLY RESERVED BY SAMTEC, INC. THIS DOCUMENT SHALL NOT BE DISCLOSED, IN WHOLE OR PART, TO ANY UNAUTHORIZED PERSON OR ENTITY NOR REPRODUCED, TRANSFERRED OR INCORPORATED IN ANY OTHER PROJECT IN ANY MANNER WITHOUT THE EXPRESS WRITTEN CONSENT OF SAMTEC, INC.

DO NOT SCALE DRAWING

SHEET SCALE: 2:1



520 PARK EAST BLVD, NEW ALBANY, IN 47150  
PHONE: 812-944-6733 FAX: 812-948-5047  
e-Mail info@SAMTEC.com code 55322

DESCRIPTION: .047" CABLE ASSEMBLY

DWG. NO. RF047-XXXXX-XXXXXX-XXXX

BY: EMMA CHEN 3/20/2013 SHEET 2 OF 3

REVISION F

-01SP  
(STRAIGHT PLUG)

(USE DRAWING No. SMA-P-C-XX-ST-C47  
FOR ASSEMBLY INSTRUCTIONS)

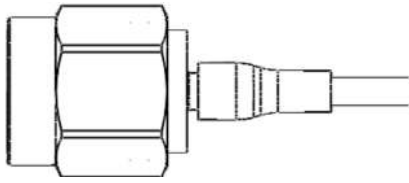

PLATING

1: 30μ" MIN. GOLD CENTER CONTACT  
3μ" MIN. GOLD OUTER CONTACT  
3μ" MIN. GOLD REMAINING METAL PARTS  
(END CONNECTOR P/N: SMA-P-C-HF-ST-C47)

NOTE: ALL CRITICAL DIMENSIONS ON SMA-P-C-XX-ST-C47  
THAT APPLY MUST BE VERIFIED.

• PROPRIETARY NOTE •  
THIS DOCUMENT CONTAINS CONFIDENTIAL AND PROPRIETARY INFORMATION AND ALL DESIGN, MANUFACTURING, REPRODUCTION, USE, PATENT RIGHTS AND SALES RIGHTS ARE EXPRESSLY RESERVED BY SAMTEC, INC. THIS DOCUMENT SHALL NOT BE DISCLOSED, IN WHOLE OR PART, TO ANY UNAUTHORIZED PERSON OR ENTITY NOR REPRODUCED, TRANSFERRED OR INCORPORATED IN ANY OTHER PROJECT IN ANY MANNER WITHOUT THE EXPRESS WRITTEN CONSENT OF SAMTEC, INC.

DO NOT SCALE DRAWING

SHEET SCALE: 2:1



520 PARK EAST BLVD, NEW ALBANY, IN 47150  
PHONE: 812-944-6733 FAX: 812-948-5047  
e-Mail info@SAMTEC.com code 55322

DESCRIPTION:	.047" CABLE ASSEMBLY	
DWG. NO.	RF047-XXXXX-XXXXXX-XXXX	
BY: EMMA CHEN	3/20/2013	SHEET 3 OF 3