

3.3V CMOS SSXO

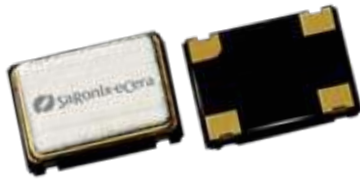

3.2 x 2.5mm Ceramic SMD

Product Features

- Wide Frequency Range – 16MHz to 67MHz
- Flexible modulation rate options
- Center Spread: $\pm 0.25\%$ to $\pm 1.15\%$
- Down Spread: -0.5% to -1.7%
- Integrated Phase-locked loop
- Output Enable with internal pull-up (default enable)
- 3.3V CMOS compatible logic levels
- Very low power consumption
- Industry standard 3.2x2.5mm ceramic SMD package
- Pb-Free and RoHS/Green compliant

Product Description

The MK Series is used in digital electronic systems to reduce the Electro-Magnetic Interference (EMI). The device uses proprietary PLL and Spread-Spectrum Clock Generator (SSCG) technology to synthesize from and modulate the frequency of the input crystal. Measured radiated energy at the fundamental and harmonic frequencies are reduced to comply with Electro Magnetic Compliance (EMC) requirement. The internal factory setting function enables flexible selection of output frequency, modulation rate and spread ratios.

Applications

- Multi-function Printers
- Wired and Wireless networking devices
- Media Players
- LCD Panel
- Digital Television
- Video Surveillance

Package:

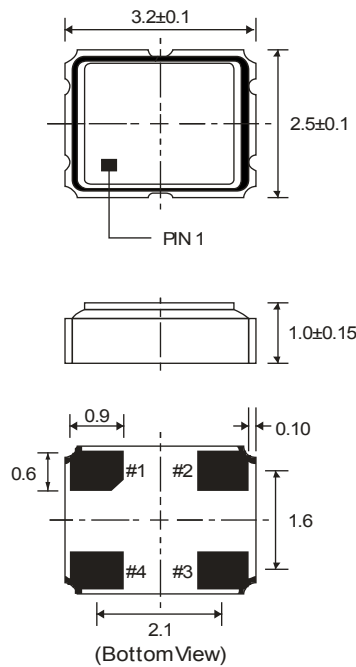

Note: All above dimensions in mm

Recommended Land Pattern:

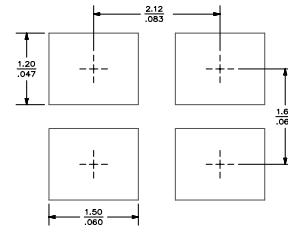

Pin Functions:

Pin	Function
1	OE Function
2	Ground
3	Clock Output
4	V _{DD}

Part Ordering Information:

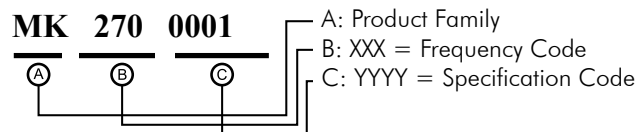

Following the above format, Saronix-eCera part numbers will be assigned upon confirmation of exact customer requirements.

Electrical Performance

Parameter	Min.	Typ.	Max.	Units	Notes
Output frequency	16		67	MHz	As specified
Supply voltage (V _{DD})	+2.97	+3.3	+3.63	V	
Supply current, output enabled			10	mA	@27mA
Frequency stability			±20 to ±50	ppm	See Note 1 below
Operating temperature	-20		+70	°C	Commercial (standard)
	-40		+85		Industrial (standard)
Output logic 0, V _{OL}			10% V _{DD}	V	
Output logic 1, V _{OH}	90% V _{DD}			V	
Output load			15	pF	
Duty cycle	45		55	%	Measured 50% V _{DD}
Rise and fall time		1.2	2.5	ns	Measured 20/80% of V _{DD}
Cycle-to-Cycle jitter		200	300	ps	

Notes:

- Stability includes all combinations of operating temperature, load changes, rated input (supply) voltage changes, initial calibration tolerance (25°C), aging (1 year at 25°C average effective ambient temperature), shock and vibration.
- For specifications other than those listed, please contact sales.

Output Enable / Disable Function

Parameter	Min.	Typ.	Max.	Units	Notes
Input Voltage (pin 1), Output Enable	$0.7 \times V_{DD}$			V	or open
Input voltage (pin 1), Output Disable (low power standby)			$0.3 \times V_{DD}$	V	Output is Hi-Z
Internal pullup resistance	50			kΩ	

Absolute Maximum Ratings

Parameter	Min.	Typ.	Max.	Units	Notes
Storage temperature	-55		+125	°C	

Spread Options Table

Center Spread	Down Spread
±0.25%	-0.5%
±0.35%	-0.7%
±0.45%	-0.9%
±0.55%	-1.1%
±0.625%	-1.3%
±0.65%	-1.7%
±0.85%	-2.0%
±1%	-2.3%
±1.15%	

Modulation Rate Options

F _{IN} / 496
F _{IN} / 608
F _{IN} / 640
F _{IN} / 750
F _{IN} / 1088

F_{IN} is the input crystal frequency

Spectral Plot without SSXO

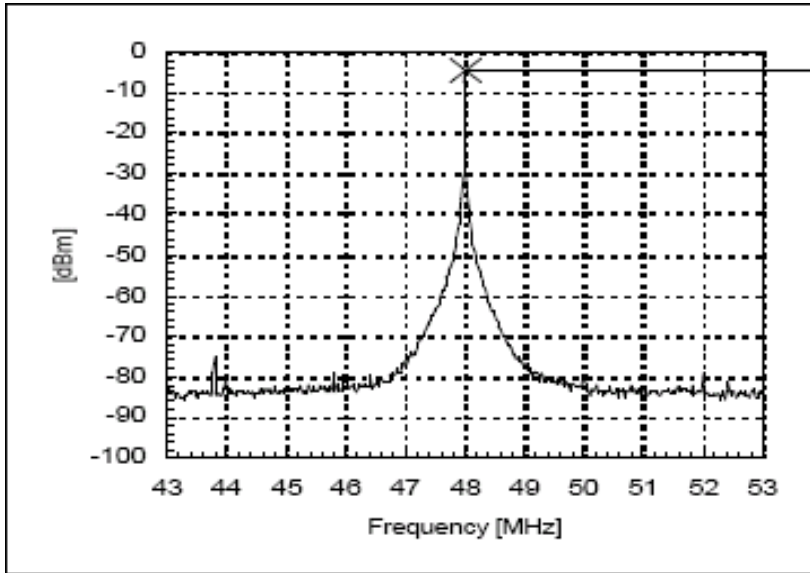

Spectral Plot with SSXO

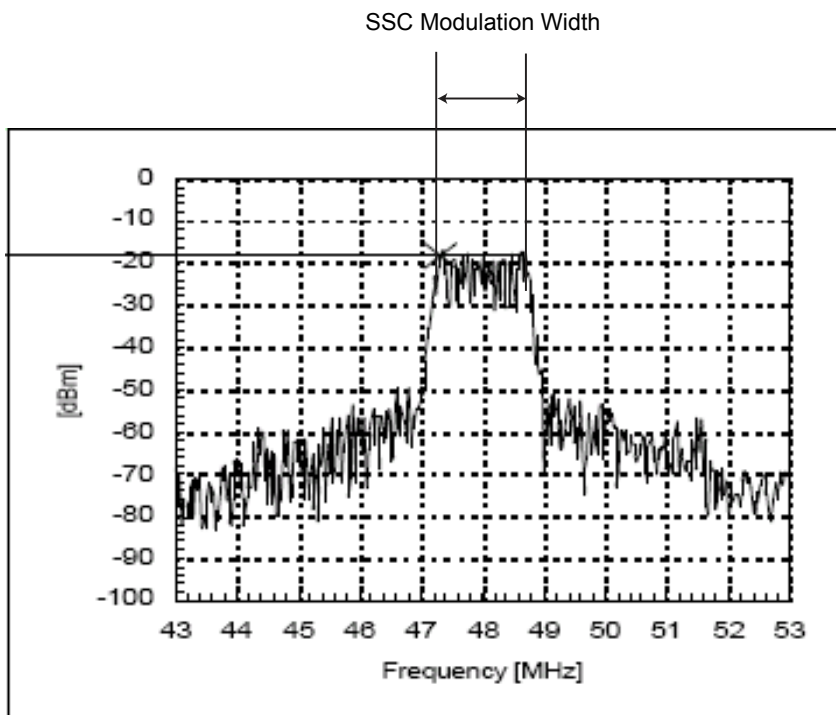

Test Circuit

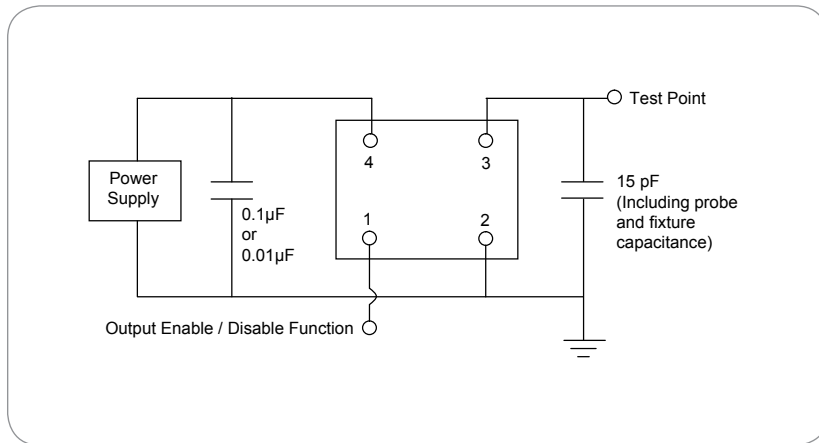

Reflow Soldering Profile

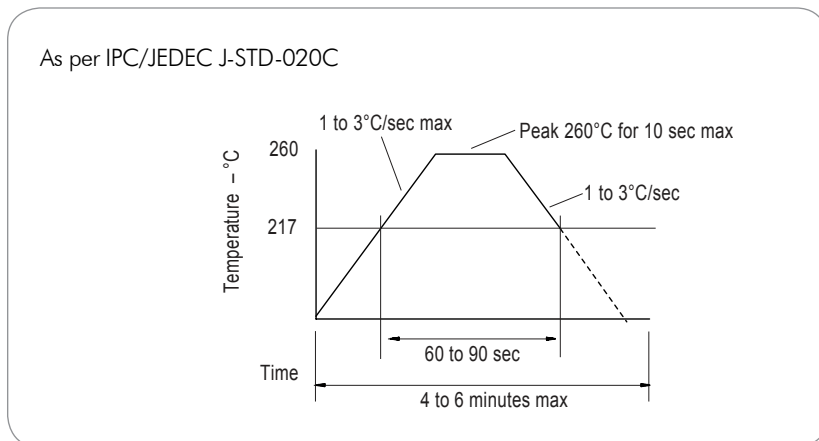

Reliability Test Ratings

This product is rated to meet the following test conditions:

Type	Parameter	Test Condition
Mechanical	Shock	MIL-STD-883, Method 2002, Condition B
Mechanical	Solderability	JESD22-B102-D Method 2 (Preconditioning E)
Mechanical	Terminal strength	MIL-STD-883, Method 2004, Condition D
Mechanical	Gross leak	MIL-STD-883, Method 1014, Condition C
Mechanical	Fine leak	MIL-STD-883, Method 1014, Condition A2 ($R_1 = 2 \times 10^{-8}$ atm cc/s)
Mechanical	Solvent resistance	MIL-STD-202, Method 215
Environmental	Thermal shock	MIL-STD-883, Method 1011, Condition A
Environmental	Moisture resistance	MIL-STD-883, Method 1004
Environmental	Vibration	MIL-STD-883, Method 2007, Condition A
Environmental	Resistance to soldering heat	J-STD-020C Table 5-2 Pb-free devices (2 cycles max)