



MAX44009 Evaluation Kit

General Description

The MAX44009 evaluation kit (EV kit) is a fully assembled and tested surface-mount PCB that evaluates the MAX44009 low-power ambient light sensor. The EV kit can be powered directly from the universal serial bus (USB) or from a single-supply voltage of 1.7V to 3.6V.

The EV kit provides an on-board I²C/SMBus interface and is connected to the computer through the USB port. The EV kit includes Windows XP[®]-, Windows Vista[®]-, and Windows[®] 7-compatible software that provides a simple user interface for exercising the device's features. The program is menu driven and offers a graphical user interface (GUI) complete with control buttons and status displays.

The on-board device can also be controlled by an external master, allowing users to test different code implementations to interface with the part.

Features

- ◆ Powered Directly from a USB Port
- ◆ On-Board Microcontroller to Generate I²C Commands
- ◆ Easy-to-Use, Menu-Driven Software
- ◆ Surface-Mount Components
- ◆ Proven PCB Layout
- ◆ Fully Assembled and Tested

Ordering Information

PART	TYPE
MAX44009EVKIT#	EV Kit

#Denotes RoHS compliant.

Component List

DESIGNATION	QTY	DESCRIPTION
C1, C12, C14, C30	4	10 μ F \pm 10%, 16V X5R ceramic capacitors (0805) Murata GRM21BR61C106K
C2, C3	2	22pF \pm 5%, 50V C0G ceramic capacitors (0603) Murata GRM1885C1H220J
C4	1	0.033 μ F \pm 10%, 16V X5R ceramic capacitor (0603) Taiyo Yuden EMK107BJ333KA
C5–C10, C17, C18	8	0.1 μ F \pm 10%, 16V X7R ceramic capacitors (0603) Murata GRM188R71C104K
C11, C13, C19, C29	4	1 μ F \pm 10%, 16V X5R ceramic capacitors (0603) TDK C1608X5R1C105K

DESIGNATION	QTY	DESCRIPTION
C15, C16	2	10pF \pm 5%, 50V C0G ceramic capacitors (0603) Murata GRM1885C1H100J
C20	0	Not installed, ceramic capacitor (0603)
H1	0	Not installed, 2 x 5-pin JTAG header
JU1–JU4	4	3-pin headers
JU5	1	2-pin header
L1	1	Ferrite bead (0603) TDK MMZ1608R301A
P1	1	Mini-USB type-B connector
R1, R2	2	27 Ω \pm 5% resistors (0603)
R3, R13, R16	3	1.5k Ω \pm 5% resistors (0603)
R4	1	470 Ω \pm 5% resistor (0603)

Windows, Windows XP, and Windows Vista are registered trademarks of Microsoft Corp.



MAX44009 Evaluation Kit

Component List (continued)

DESIGNATION	QTY	DESCRIPTION
R5	1	2.2k Ω \pm 5% resistor (0603)
R6, R15	2	10k Ω \pm 5% resistors (0603)
R7–R11	0	Not installed, resistors—short (PC trace) (0402)
R17	1	100k Ω \pm 5% resistor (0603)
U1	1	Ambient light sensor (6 UTDFN-Opto-EP) Maxim MAX44009EDT+
U2	1	Microcontroller (68 QFN-EP) Maxim MAXQ2000-RAX+
U3	1	LDO regulator (5 SC70) Maxim MAX8511EXK25+
U4, U5	2	LDO regulators (5 SC70) Maxim MAX8511EXK33+

DESIGNATION	QTY	DESCRIPTION
U6	1	UART-to-USB converter (32 TQFP)
U7	1	93C46-type 3-wire EEPROM (8 SO)
Y1	1	16MHz crystal Hong Kong X'tals SSM16000N1HK188F0-0
Y2	1	6MHz crystal Hong Kong X'tals SSL6000N1HK188F0-0
—	5	Shunts
—	1	PCB: MAX44009 EVALUATION KIT

Component Suppliers

SUPPLIER	PHONE	WEBSITE
Hong Kong X'tals Ltd.	852-35112388	www.hongkongcrystal.com
Murata Electronics North America, Inc.	770-436-1300	www.murata-northamerica.com
Taiyo Yuden	800-348-2496	www.t-yuden.com
TDK Corp.	847-803-6100	www.component.tdk.com

Note: Indicate that you are using the MAX44009 when contacting these component suppliers.

MAX44009 EV Kit Files

PART	DESCRIPTION
INSTALL.EXE	Installs the EV kit files on your computer
MAX44009.EXE	Application program
FTD2XX.INF	USB device driver file
UNINST.INI	Uninstalls the EV kit software
USB_Driver_Help.PDF	USB driver installation help file

MAX44009 Evaluation Kit

Quick Start

Recommended Equipment

- MAX44009 EV kit
- User-supplied Windows XP, Windows Vista, or Windows 7 PC with a spare USB port

Note: In the following sections, software-related items are identified by bolding. Text in **bold** refers to items directly from the EV Kit software. Text in **bold and underlined** refers to items from the Windows operating system.

Procedure

The EV kit is fully assembled and tested. Follow the steps below to verify board operation:

- 1) Visit www.maxim-ic.com/evkitsoftware to download the latest version of the EV kit software, 44009Rxx.ZIP. Save the EV kit software to a temporary folder and uncompress the ZIP file.
- 2) Install the EV kit software on your computer by running the INSTALL.EXE program inside the temporary folder. The program files are copied and icons are created in the Windows **Start | Programs** menu.
- 3) Verify that a shunt is installed across pins 2-3 on jumper JU4 (USB powered).
- 4) Connect the USB cable from the PC to the EV kit board. A **New Hardware Found** windows pops up when installing the USB driver for the first time. If you do not see a window that is similar to the one described above after 30s, remove the USB cable from the board and reconnect it. Administrator privileges are required to install the USB device driver on Windows.
- 5) Follow the directions of the **Add New Hardware** wizard to install the USB device driver. Choose the **Search for the best driver for your device** option. Specify the location of the device driver to be **C:\Program Files\MAX44009** (default installation

directory) using the **Browse** button. During device driver installation, Windows may show a warning message indicating that the device driver Maxim uses does not contain a digital signature. This is not an error condition and it is safe to proceed with installation. Refer to the USB_Driver_Help.PDF document included with the software for additional information.

- 6) Start the EV kit software by opening its icon in the **Start | Programs** menu. The EV kit software main window appears, as shown in Figure 1. Observe as the program automatically detects the EV kit and starts the main program.
- 7) Monitor and verify the ambient light lux reading of the EV kit. See the *Detailed Description of Software* section to evaluate the features of the EV kit.

Detailed Description of Software

The MAX44009 EV kit software GUI (Figure 1) is a Windows program that provides a convenient means to control the MAX44009. The EV kit software accurately reads the device's digital output and displays the lux reading of ambient light. The software has an option to extend the resolution and dynamic range of lux measurements. The software also sets the upper and lower lux threshold limits, configures the interrupt functionality, and configures other modes of device. Refer to the *Register and Bit Descriptions* section in the MAX44009 IC data sheet for further details.

The **Data Log** checkbox enables the user to log the lux readings data.

Simple SMBus Commands

There are two methods for communicating with the device, through the EV kit software main window (Figure 1), or through the interface window available by selecting the **Options | Interface (Advanced Users)** menu item from the menu bar. The Maxim command module interface window (Figure 2) includes a **2-wire interface** tab that allows for execution of the frequently used commands.

MAX44009 Evaluation Kit

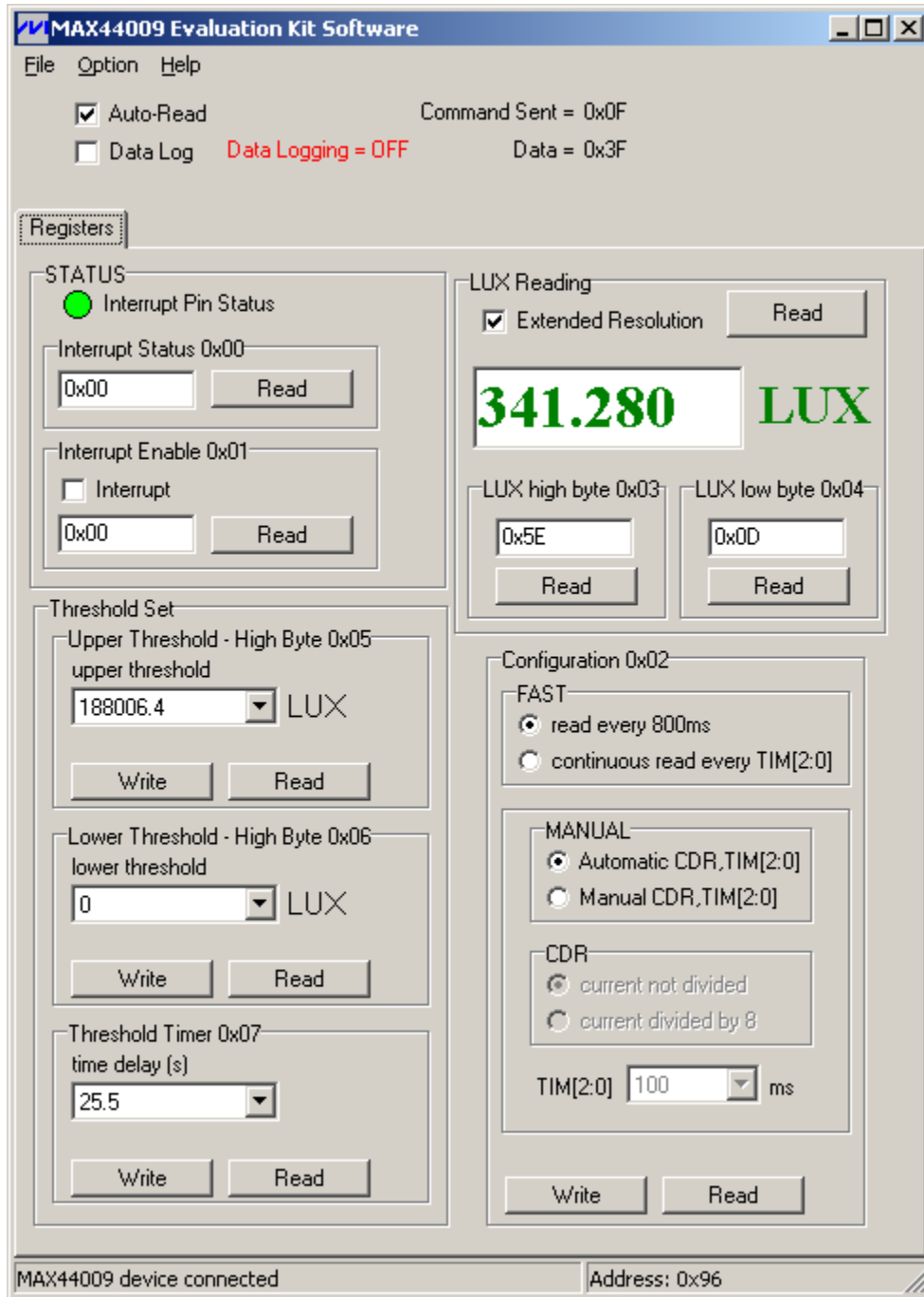

Figure 1. MAX44009 EV Kit Software Main Window

MAX44009 Evaluation Kit

Evaluates: MAX44009

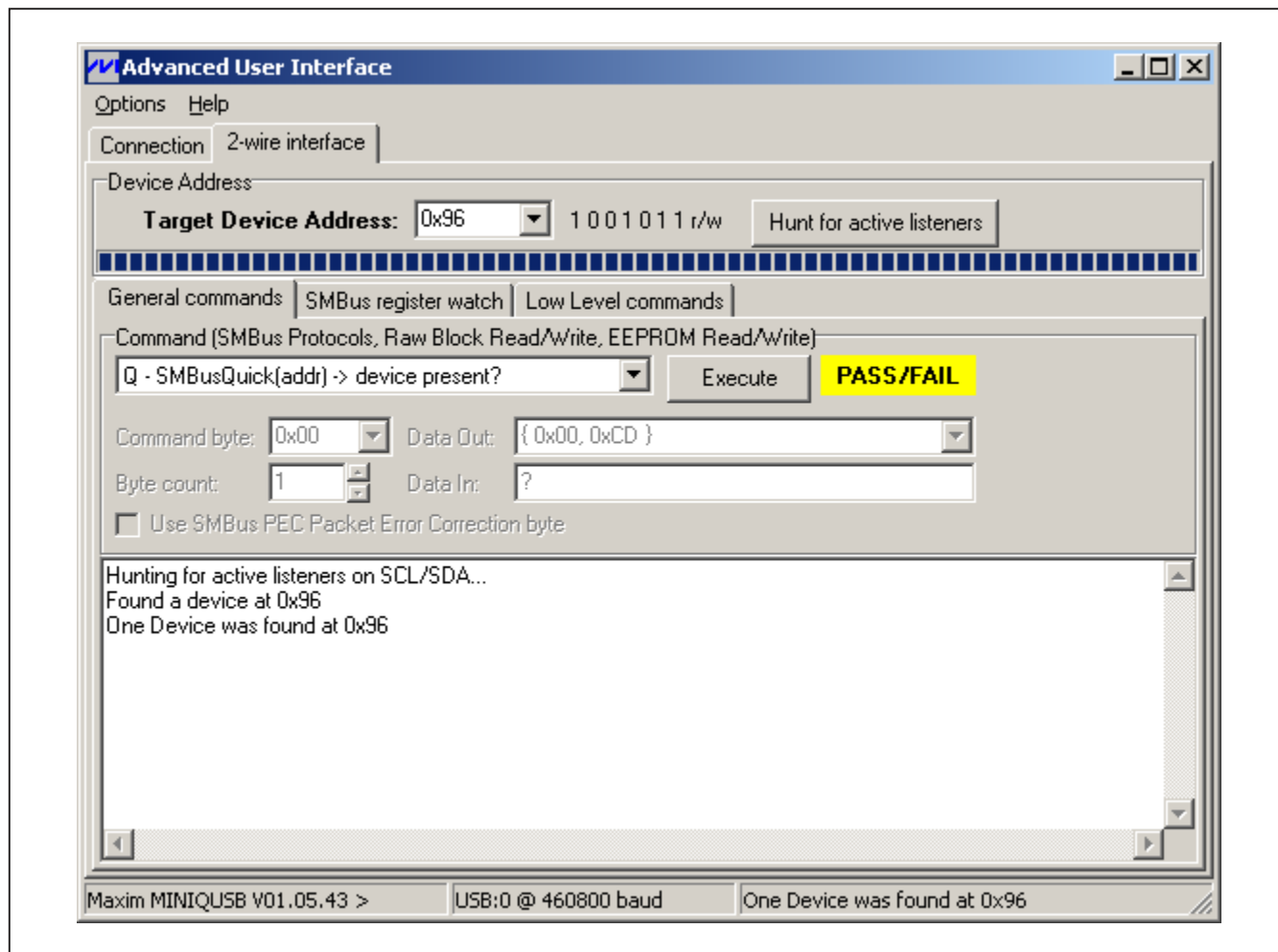

Figure 2. MAX44009 Interface Diagnostic Window

Detailed Description of Hardware

I²C Bus Lines

The MAX44009 EV kit features an on-board I²C/SMBus interface control through the USB. To use the EV kit with a user-supplied I²C/SMBus interface, move the shunts on jumpers JU1 and JU2 to the 2-3 position. Then connect the SDA and SCL signals to the corresponding SDA and SCL PCB pads on the EV kit board. Table 1 lists the selectable jumper options.

Hardware Interrupt

The EV kit features an on-board hardware-interrupt control. To use the EV kit with a user-supplied interrupt interface, move the shunt on jumper JU3 to the 2-3 position. Then, connect the INT signal to the INT PCB pad on the EV kit board. Table 2 lists the selectable jumper options.

Power Input

The device can operate from a single-supply VCC between 1.7V and 3.6V. Using the 3-pin jumper JU4, the device can be powered either by the on-board 1.8V power supply (default shunt position across pins 1-2) or by an external power supply (shunt across pins 2-3). Table 3 lists the selectable jumper options.

Bit 0 of I²C Address

The EV kit provides 2-pin jumper JU5 to configure the state of the A0 address pin. Table 4 lists the selectable jumper options.

MAX44009 Evaluation Kit

Evaluates: MAX44009

Table 1. Jumpers JU1 and JU2 Function (SDA and SCL)

JUMPER	SHUNT POSITION	DESCRIPTION
JU1	1-2*	Connects the device's SDA to on-board I ² C master
	2-3	Connects the device's SDA to user-supplied external I ² C master
JU2	1-2*	Connects the device's SCL to on-board I ² C master
	2-3	Connects the device's SCL to user-supplied external I ² C master

*Default position.

Table 2. Jumper JU3 Function ($\overline{\text{INT}}$)

SHUNT POSITION	DESCRIPTION
1-2*	Connects the device's $\overline{\text{INT}}$ to on-board I ² C master
2-3	Connects the device's $\overline{\text{INT}}$ to external user-supplied I ² C master

*Default position.

Table 3. Jumper JU4 Function (VCC)

SHUNT POSITION	DESCRIPTION
1-2	The EV kit requires an external power supply applied at the VDD pad
2-3*	The device is powered through 3.3V generated from the host PC's USB port

*Default position.

Table 4. Jumper JU5 Function (A0)

SHUNT POSITION	DESCRIPTION
Installed	A0 pulled to GND; the device's I ² C interface slave address selected as 1001010x
Not installed	A0 pulled to VCC through R17; the device's I ² C interface slave address selected as 1001011x

*Default position.

Note: x is the read/write bit.

MAX44009 Evaluation Kit

Evaluates: MAX44009

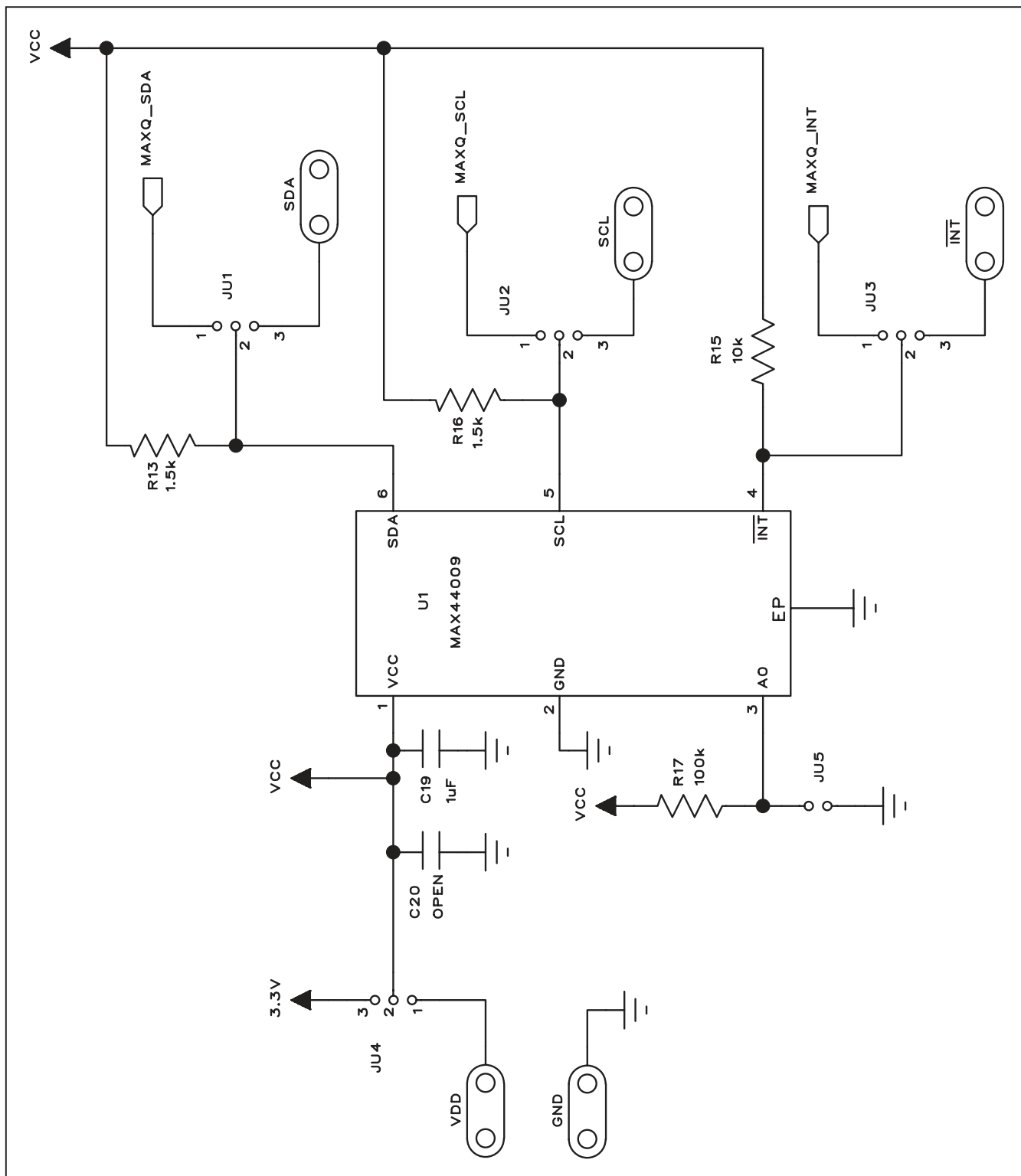

Figure 3a. MAX44009 EV Kit Schematic (Sheet 1 of 2)

MAX44009 Evaluation Kit

Evaluates: MAX44009

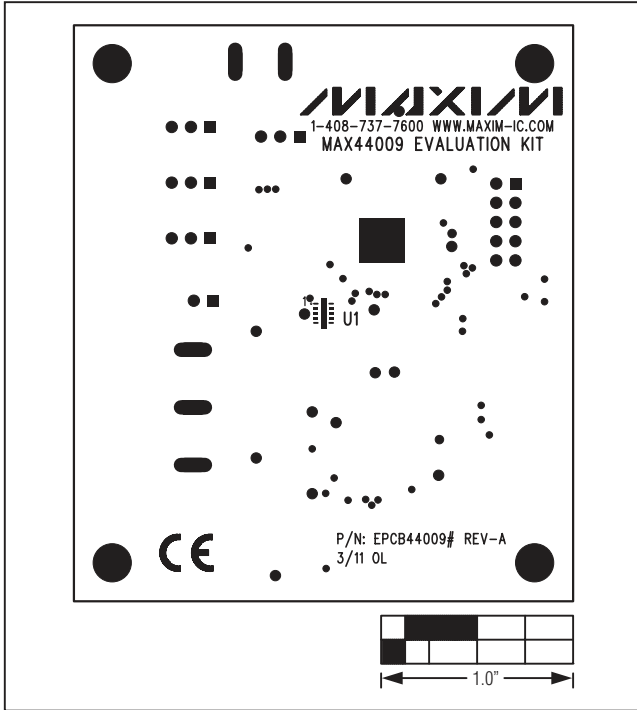

Figure 4. MAX44009 EV Kit Component Placement Guide—Component Side

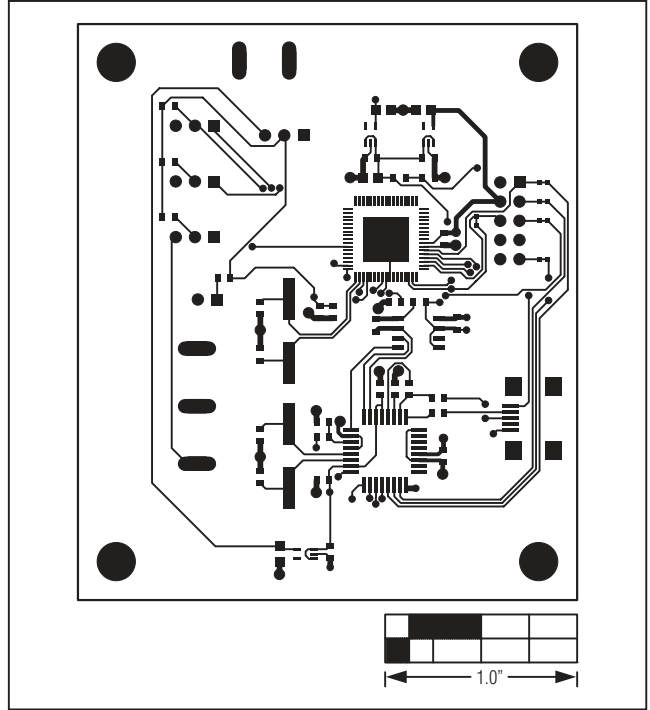

Figure 6. MAX44009 EV Kit PCB Layout—Solder Side

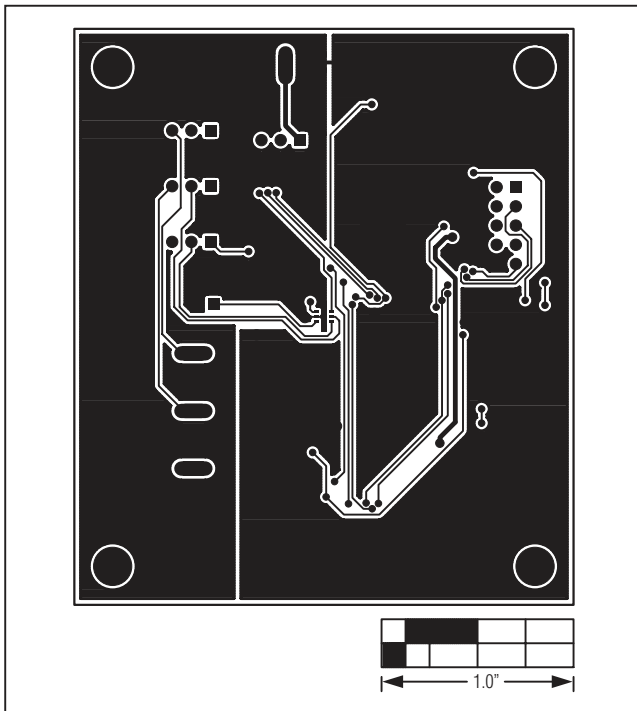

Figure 5. MAX44009 EV Kit PCB Layout—Component Side

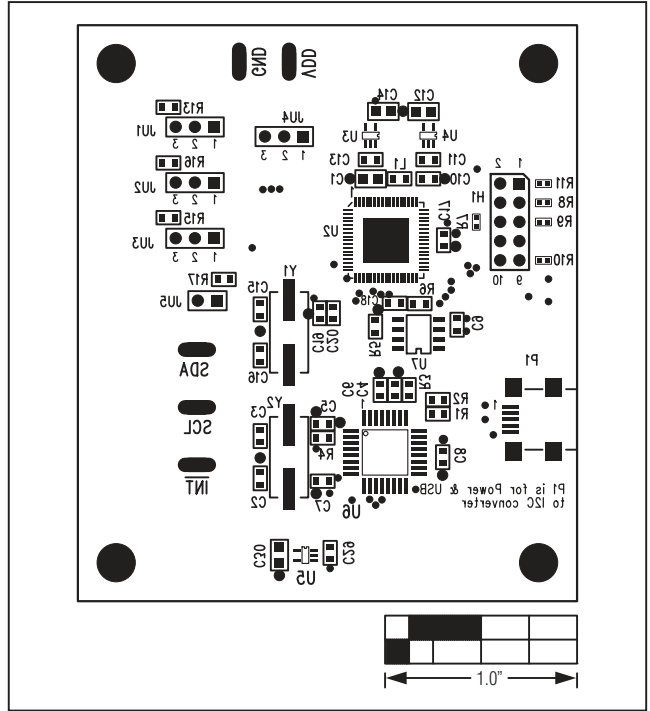

Figure 7. MAX44009 EV Kit Component Placement Guide—Solder Side

MAX44009 Evaluation Kit

Revision History

REVISION NUMBER	REVISION DATE	DESCRIPTION	PAGES CHANGED
0	3/11	Initial release	—

Maxim cannot assume responsibility for use of any circuitry other than circuitry entirely embodied in a Maxim product. No circuit patent licenses are implied. Maxim reserves the right to change the circuitry and specifications without notice at any time.

10 **Maxim Integrated Products, 120 San Gabriel Drive, Sunnyvale, CA 94086 408-737-7600**