

High Power LED Series Chip Scale Package Array

LH309A

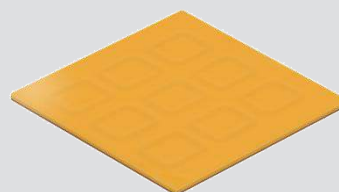

Making use of CSP, Samsung's fundamental "building block", provide with greater design flexibility and better light quality



Features & Benefits

- Utilizes Samsung TF chip and Flexible substrate platform technology
- Suitable for use in indoor and outdoor directional lighting
- 80 CRI makes it well suited for most applications
- Compact footprint (5.0 x 5.0 mm)

Applications

- Indoor Lighting: Spotlight, Downlight, MR, PAR
- Industrial Lighting: High Bay Light, Low Bay Light
- Consumer Lighting: Torch Light

Table of Contents

1.	Characteristics	-----	3
2.	Product Code Information	-----	5
3.	Typical Characteristics Graphs	-----	15
4.	Outline Drawing & Dimension	-----	17
5.	Reliability Test Items & Conditions	-----	18
6.	Soldering Conditions	-----	19
7.	Tape & Reel	-----	20
8.	Label Structure	-----	22
9.	Packing Structure	-----	23
10.	Precautions in Handling & Use	-----	25

1. Characteristics

a) Absolute Maximum Rating

Item	Symbol	Rating	Unit	Condition
Ambient / Operating Temperature	T_a	-40 ~ +105	°C	Note 1)
Storage Temperature	T_{stg}	-40 ~ +120	°C	-
LED Junction Temperature	T_j	130	°C	-
Forward Current	I_F	250	mA	-
Assembly Process Temperature	-	260 <10	°C s	-
ESD (HBM)	-	±2	kV	-

Note:

- 1) Refer to the derating curve, '3. Typical Characteristics Graph', for proper driving current that maintained below maximum junction temperature.

b) Electro-optical Characteristics (IF = 150 mA)

Item	Unit	Nominal CCT (K)	Condition		Value Typ.
			I _F (mA)	T _s (°C)	
Luminous Flux (Φ _v)	lm	2700 (80 CRI)	150	25	533
			150	85	495
			200	85	637
			250	85	771
Forward Voltage (V _F)	V		150	25	26.9
			150	85	26.0
			200	85	26.4
			250	85	26.8
Reverse Voltage (@ -10 μA)	V				(min) -10.0
Thermal Resistance (junction to solder point)	°C/W				1.2
Beam Angle	°				120

Note:

Samsung maintains measurement tolerance of: luminous flux = ±7%, forward voltage = ±0.1 V

2. Product Code Information

1	2	3	4	5	6	7	8	9	10	11	12	13	14	15	16	17	18
S	C	A	8	W	T	7	8	H	A	L	9	W	0	6	D	E	P

Digit	PKG Information	Code	Specification	
1 2 3	Samsung Chip Scale Package Array	SCA		
4	CRI	7 E 8 9	Min. 70 Min 75 Min. 80 Min. 90	
5	CCT	W V U T R Q P	2700K 3000K 3500K 4000K 5000K 5700K 6500K	
6	Chip Shape	T	Square type	
7 8 9	Product	78H	Chip version	
10 11 12	Product Purpose	AL9	9 chip in 1 array	
13 14	CCT (K)	W 0 V 0 U 0 T 0 R T Q T P T	2700 3000 3500 4000 5000 5700 6500	W1, W2, W3, W4, W5, W6, W7, W8, W9, WA, WB, WC, WD, WE, WF, WG V1, V2, V3, V4, V5, V6, V7, V8, V9, VA, VB, VC, VD, VE, VF, VG U1, U2, U3, U4, U5, U6, U7, U8, U9, UA, UB, UC, UD, UE, UF, UG Bin Code: T1, T2, T3, T4, T5, T6, T7, T8, T9, TA, TB, TC, TD, TE, TF, TG R1, R2, R3, R4 Q1, Q2, Q3, Q4 P1, P2, P3, P4
15 16	Luminous Flux	06 28 4A 6D 8F AJ	365 ~ 445 lm 390 ~ 475 lm 415 ~ 510 lm 445 ~ 545 lm 475 ~ 585 lm 510 ~ 625 lm	02 365 ~ 390 24 390 ~ 415 46 415 ~ 445 68 445 ~ 475 8A 475 ~ 510 AD 510 ~ 545 DF 545 ~ 585 FJ 585 ~ 625
			Digit 15: Min. spec Digit 18: Max. spec e.g.: 8A = 475~510 lm, 8F = 8A + AD + DF = 475~585 lm	
17 18	Forward Voltage (Vf)	EP	23.75 ~ 28.25 V	

a) Luminous Flux Bins and Characteristics ($I_F = 150 \text{ mA}$, $T_s = 85^\circ\text{C}$)

CRI (R_a) Min. ¹⁾	Nominal CCT (K)	Product Code	Sorting @ 150 mA (lm)		Calculated Minimum Flux ²⁾ (lm)		
			Flux Rank	Flux Range ¹⁾	@ 150 mA (25°C)	@ 200 mA	@ 250 mA
70	3000	<i>SCA7VT78HAL9V08FEP</i>	DF	545 ~ 585	589	710	859
			AD	510 ~ 545	551	665	804
			8A	475 ~ 510	514	619	749
	3500	<i>SCA7UT78HAL9U0AJEP</i>	FJ	585 ~ 625	632	762	922
			DF	545 ~ 585	589	710	859
			AD	510 ~ 545	551	665	804
	4000	<i>SCA7TT78HAL9T0AJEP</i>	FJ	585 ~ 625	632	762	922
			DF	545 ~ 585	589	710	859
			AD	510 ~ 545	551	665	804
	5000	<i>SCA7RT78HAL9RTAJEP</i>	FJ	585 ~ 625	632	762	922
			DF	545 ~ 585	589	710	859
			AD	510 ~ 545	551	665	804
	5700	<i>SCA7QT78HAL9QTAJEP</i>	FJ	585 ~ 625	632	762	922
			DF	545 ~ 585	589	710	859
			AD	510 ~ 545	551	665	804
	6500	<i>SCA7PT78HAL9PTAJEP</i>	FJ	585 ~ 625	632	762	922
			DF	545 ~ 585	589	710	859
			AD	510 ~ 545	551	665	804

Notes:

- 1) Samsung maintains measurement tolerance of: luminous flux = $\pm 7\%$, CRI = ± 3
- 2) Calculated minimum and maximum flux values are for reference only

a) Luminous Flux Bins and Characteristics ($I_F = 150 \text{ mA}$, $T_s = 85^\circ\text{C}$)

CRI (R_a) Min. ¹⁾	Nominal CCT (K)	Product Code	Sorting @ 150 mA (lm)		Calculated Minimum Flux ²⁾ (lm)		
			Flux Rank	Flux Range ¹⁾	@ 150 mA (25°C)	@ 200 mA	@ 250 mA
80	2700	<i>SCA8WT78HAL9W06DEP</i>	AD	510 ~ 545	551	665	804
			8A	475 ~ 510	514	619	749
			68	445 ~ 475	481	580	701
	3000	<i>SCA8VT78HAL9V06DEP</i>	AD	510 ~ 545	551	665	804
			8A	475 ~ 510	514	619	749
			68	445 ~ 475	481	580	701
	3500	<i>SCA8UT78HAL9U08FEP</i>	DF	545 ~ 585	589	710	859
			AD	510 ~ 545	551	665	804
			8A	475 ~ 510	514	619	749
	4000	<i>SCA8TT78HAL9T08FEP</i>	DF	545 ~ 585	589	710	859
			AD	510 ~ 545	551	665	804
			8A	475 ~ 510	514	619	749
5000	<i>SCA8RT78HAL9RTAJEP</i>	FJ	585 ~ 625	632	762	922	
		DF	545 ~ 585	589	710	859	
		AD	510 ~ 545	551	665	804	

Notes:

- 1) Samsung maintains measurement tolerance of: luminous flux = $\pm 7\%$, CRI = ± 3
- 2) Calculated minimum and maximum flux values are for reference only

a) Luminous Flux Bins and Characteristics ($I_F = 150 \text{ mA}$, $T_s = 85^\circ\text{C}$)

CRI (R_a) Min. ¹⁾	Nominal CCT (K)	Product Code	Sorting @ 150 mA (lm)		Calculated Minimum Flux ²⁾ (lm)		
			Flux Rank	Flux Range ¹⁾	@ 150 mA (25°C)	@ 200 mA	@ 250 mA
90	2700	<i>SCA9WT78HAL9W006EP</i>	46	415 ~ 445	449	541	654
			24	390 ~ 415	422	508	615
			02	365 ~ 390	395	476	575
	3000	<i>SCA9VT78HAL9V028EP</i>	68	445 ~ 475	481	580	701
			46	415 ~ 445	449	541	654
			24	390 ~ 415	422	508	615
	3500	<i>SCA9UT78HAL9U028EP</i>	68	445 ~ 475	481	580	701
			46	415 ~ 445	449	541	654
			24	390 ~ 415	422	508	615
	4000	<i>SCA9TT78HAL9T028EP</i>	68	445 ~ 475	481	580	701
			46	415 ~ 445	449	541	654
			24	390 ~ 415	422	508	615

Notes:

- 1) Samsung maintains measurement tolerance of: luminous flux = $\pm 7\%$, CRI = ± 3
- 2) Calculated minimum and maximum flux values are for reference only

b) Color Bins ($I_F = 150 \text{ mA}$, $T_s = 85 \text{ }^\circ\text{C}$)

CRI (R_a) Min.	Nominal CCT (K)	Product Code	Color Rank	Chromaticity Bins
70	3000	<i>SCA7VT78HAL9V08FEP</i>	V0 (Whole bin)	V1, V2, V3, V4, V5, V6, V7, V8, V9, VA, VB, VC, VD, VE, VF, VG
	3500	<i>SCA7UT78HAL9U0AJEP</i>	U0 (Whole bin)	U1, U2, U3, U4, U5, U6, U7, U8, U9, UA, UB, UC, UD, UE, UF, UG
	4000	<i>SCA7TT78HAL9T0AJEP</i>	T0 (Whole bin)	T1, T2, T3, T4, T5, T6, T7, T8, T9, TA, TB, TC, TD, TE, TF, TG
	5000	<i>SCA7RT78HAL9RTAJEP</i>	RT (ANSI bin)	R1, R2, R3, R4
	5700	<i>SCA7QT78HAL9QTAJEP</i>	QT (ANSI bin)	Q1, Q2, Q3, Q4
	6500	<i>SCA7PT78HAL9PTAJEP</i>	PT (ANSI bin)	P1, P2, P3, P4
80	2700	<i>SCA8WT78HAL9W06DEP</i>	W0 (Whole bin)	W1, W2, W3, W4, W5, W6, W7, W8, W9, WA, WB, WC, WD, WE, WF, WG
	3000	<i>SCA8VT78HAL9V06DEP</i>	V0 (Whole bin)	V1, V2, V3, V4, V5, V6, V7, V8, V9, VA, VB, VC, VD, VE, VF, VG
	3500	<i>SCA8UT78HAL9U08FEP</i>	U0 (Whole bin)	U1, U2, U3, U4, U5, U6, U7, U8, U9, UA, UB, UC, UD, UE, UF, UG
	4000	<i>SCA8TT78HAL9T08FEP</i>	T0 (Whole bin)	T1, T2, T3, T4, T5, T6, T7, T8, T9, TA, TB, TC, TD, TE, TF, TG
	5000	<i>SCA8RT78HAL9RTAJEP</i>	RT (ANSI bin)	R1, R2, R3, R4
90	2700	<i>SCA9WT78HAL9W006EP</i>	W0 (Whole bin)	W1, W2, W3, W4, W5, W6, W7, W8, W9, WA, WB, WC, WD, WE, WF, WG
	3000	<i>SCA9VT78HAL9V028EP</i>	V0 (Whole bin)	V1, V2, V3, V4, V5, V6, V7, V8, V9, VA, VB, VC, VD, VE, VF, VG
	3500	<i>SCA9UT78HAL9U028EP</i>	U0 (Whole bin)	U1, U2, U3, U4, U5, U6, U7, U8, U9, UA, UB, UC, UD, UE, UF, UG
	4000	<i>SCA9TT78HAL9T028EP</i>	T0 (Whole bin)	T1, T2, T3, T4, T5, T6, T7, T8, T9, TA, TB, TC, TD, TE, TF, TG

c) Voltage Bins ($I_f = 150 \text{ mA}$, $T_s = 85 \text{ °C}$)

CRI (R_a) Min.	Nominal CCT (K)	Product Code	Voltage Rank	Voltage Bin	Voltage Range (V)
			EP		23.75 ~ 28.25

d) Chromaticity Region & Coordinates ($I_f = 150 \text{ mA}$, $T_s = 85^\circ\text{C}$)

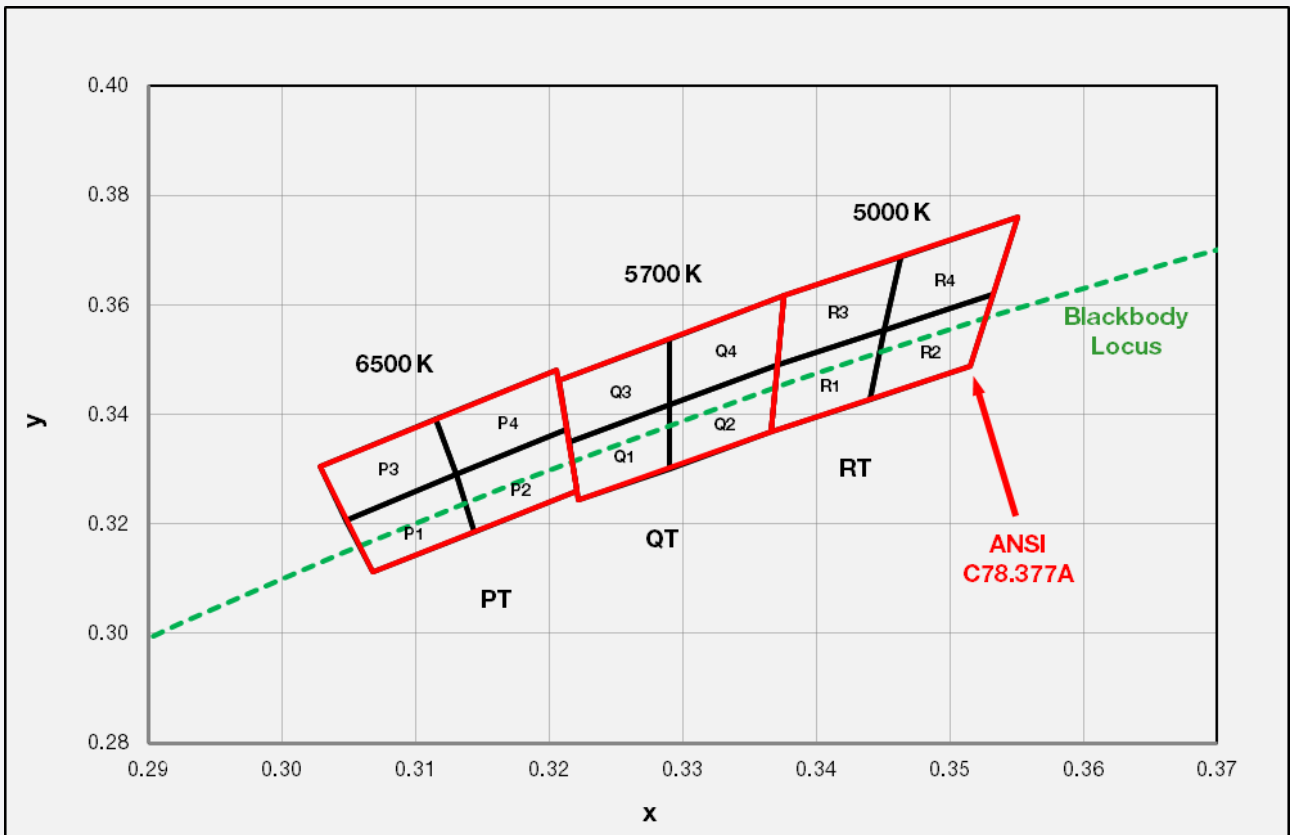
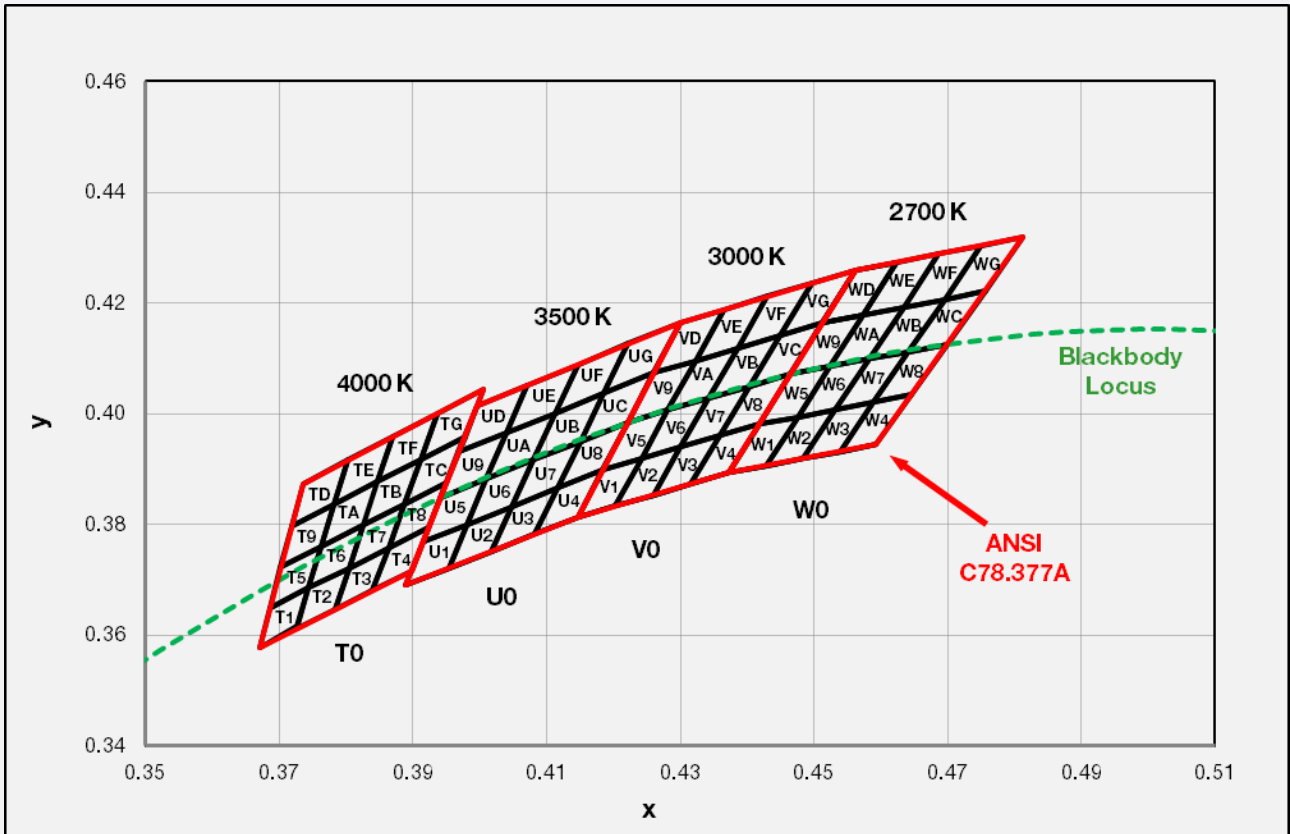

d) Chromaticity Region & Coordinates ($I_F = 150 \text{ mA}$, $T_s = 85 \text{ }^\circ\text{C}$)

Region	CIE x	CIE y	Region	CIE x	CIE y
W rank (2700 K)					
W1	0.4373	0.3893	W9	0.4465	0.4071
	0.4418	0.3981		0.4513	0.4164
	0.4475	0.3994		0.4573	0.4178
	0.4428	0.3906		0.4523	0.4085
W2	0.4428	0.3906	WA	0.4523	0.4085
	0.4475	0.3994		0.4573	0.4178
	0.4532	0.4008		0.4634	0.4193
	0.4483	0.3919		0.4582	0.4099
W3	0.4483	0.3919	WB	0.4582	0.4099
	0.4532	0.4008		0.4634	0.4193
	0.4589	0.4021		0.4695	0.4207
	0.4538	0.3931		0.4641	0.4112
W4	0.4538	0.3931	WC	0.4641	0.4112
	0.4589	0.4021		0.4695	0.4207
	0.4646	0.4034		0.4756	0.4221
	0.4593	0.3944		0.4700	0.4126
W5	0.4418	0.3981	WD	0.4513	0.4164
	0.4465	0.4071		0.4562	0.4260
	0.4523	0.4085		0.4624	0.4274
	0.4475	0.3994		0.4573	0.4178
W6	0.4475	0.3994	WE	0.4573	0.4178
	0.4523	0.4085		0.4624	0.4274
	0.4582	0.4099		0.4687	0.4289
	0.4532	0.4008		0.4634	0.4193
W7	0.4532	0.4008	WF	0.4634	0.4193
	0.4582	0.4099		0.4687	0.4289
	0.4641	0.4112		0.4750	0.4304
	0.4589	0.4021		0.4695	0.4207
W8	0.4589	0.4021	WG	0.4695	0.4207
	0.4641	0.4112		0.4750	0.4304
	0.4700	0.4126		0.4813	0.4319
	0.4646	0.4034		0.4756	0.4221

Region	CIE x	CIE y	Region	CIE x	CIE y
V rank (3000 K)					
V1	0.4147	0.3814	V9	0.4221	0.3984
	0.4183	0.3898		0.4259	0.4073
	0.4242	0.3919		0.4322	0.4096
	0.4203	0.3833		0.4281	0.4006
V2	0.4203	0.3833	VA	0.4281	0.4006
	0.4242	0.3919		0.4322	0.4096
	0.4300	0.3939		0.4385	0.4119
	0.4259	0.3853		0.4342	0.4028
V3	0.4259	0.3853	VB	0.4342	0.4028
	0.4300	0.3939		0.4385	0.4119
	0.4359	0.3960		0.4449	0.4141
	0.4316	0.3873		0.4403	0.4049
V4	0.4316	0.3873	VC	0.4403	0.4049
	0.4359	0.3960		0.4449	0.4141
	0.4418	0.3981		0.4513	0.4164
	0.4373	0.3893		0.4465	0.4071
V5	0.4183	0.3898	VD	0.4259	0.4073
	0.4221	0.3984		0.4299	0.4165
	0.4281	0.4006		0.4364	0.4188
	0.4242	0.3919		0.4322	0.4096
V6	0.4242	0.3919	VE	0.4322	0.4096
	0.4281	0.4006		0.4364	0.4188
	0.4342	0.4028		0.4430	0.4212
	0.4300	0.3939		0.4385	0.4119
V7	0.4300	0.3939	VF	0.4385	0.4119
	0.4342	0.4028		0.4430	0.4212
	0.4403	0.4049		0.4496	0.4236
	0.4359	0.3960		0.4449	0.4141
V8	0.4359	0.3960	VG	0.4449	0.4141
	0.4403	0.4049		0.4496	0.4236
	0.4465	0.4071		0.4562	0.4260
	0.4418	0.3981		0.4513	0.4164

d) Chromaticity Region & Coordinates

Region	CIE x	CIE y	Region	CIE x	CIE y
U rank (3500 K)					
U1	0.3889	0.3690	U9	0.3941	0.3848
	0.3915	0.3768		0.3968	0.3930
	0.3981	0.3800		0.4040	0.3966
	0.3953	0.3720		0.4010	0.3882
U2	0.3953	0.3720	UA	0.4010	0.3882
	0.3981	0.3800		0.4040	0.3966
	0.4048	0.3832		0.4113	0.4001
	0.4017	0.3751		0.4080	0.3916
U3	0.4017	0.3751	UB	0.4080	0.3916
	0.4048	0.3832		0.4113	0.4001
	0.4116	0.3865		0.4186	0.4037
	0.4082	0.3782		0.4150	0.3950
U4	0.4082	0.3782	UC	0.4150	0.3950
	0.4116	0.3865		0.4186	0.4037
	0.4183	0.3898		0.4259	0.4073
	0.4147	0.3814		0.4221	0.3984
U5	0.3915	0.3768	UD	0.3968	0.3930
	0.3941	0.3848		0.3996	0.4015
	0.4010	0.3882		0.4071	0.4052
	0.3981	0.3800		0.4040	0.3966
U6	0.3981	0.3800	UE	0.4040	0.3966
	0.4010	0.3882		0.4071	0.4052
	0.4080	0.3916		0.4146	0.4089
	0.4048	0.3832		0.4113	0.4001
U7	0.4048	0.3832	UF	0.4113	0.4001
	0.4080	0.3916		0.4146	0.4089
	0.4150	0.3950		0.4222	0.4127
	0.4116	0.3865		0.4186	0.4037
U8	0.4116	0.3865	UG	0.4186	0.4037
	0.4150	0.3950		0.4222	0.4127
	0.4221	0.3984		0.4299	0.4165
	0.4183	0.3898		0.4259	0.4073

Region	CIE x	CIE y	Region	CIE x	CIE y
T rank (4000 K)					
T1	0.3670	0.3578	T9	0.3702	0.3722
	0.3726	0.3612		0.3763	0.3760
	0.3744	0.3685		0.3782	0.3837
	0.3686	0.3649		0.3719	0.3797
T2	0.3726	0.3612	TA	0.3763	0.3760
	0.3783	0.3646		0.3825	0.3798
	0.3804	0.3721		0.3847	0.3877
	0.3744	0.3685		0.3782	0.3837
T3	0.3783	0.3646	TB	0.3825	0.3798
	0.3840	0.3681		0.3887	0.3836
	0.3863	0.3758		0.3912	0.3917
	0.3804	0.3721		0.3847	0.3877
T4	0.3840	0.3681	TC	0.3887	0.3837
	0.3898	0.3716		0.3950	0.3875
	0.3924	0.3794		0.3978	0.3958
	0.3863	0.3758		0.3912	0.3917
T5	0.3686	0.3649	TD	0.3719	0.3797
	0.3744	0.3685		0.3782	0.3837
	0.3763	0.3760		0.3802	0.3916
	0.3702	0.3722		0.3736	0.3874
T6	0.3744	0.3685	TE	0.3782	0.3837
	0.3804	0.3721		0.3847	0.3877
	0.3825	0.3798		0.3869	0.3958
	0.3763	0.376		0.3802	0.3916
T7	0.3804	0.3721	TF	0.3847	0.3877
	0.3863	0.3758		0.3912	0.3917
	0.3887	0.3836		0.3937	0.4001
	0.3825	0.3798		0.3869	0.3958
T8	0.3863	0.3758	TG	0.3912	0.3917
	0.3924	0.3794		0.3978	0.3958
	0.3950	0.3875		0.4006	0.4044
	0.3887	0.3836		0.3937	0.4001

d) Chromaticity Region & Coordinates

Region	CIE x	CIE y
R rank (5000 K)		
R1	0.3371	0.3490
	0.3451	0.3554
	0.3440	0.3427
	0.3366	0.3369
R2	0.3451	0.3554
	0.3533	0.3620
	0.3515	0.3487
	0.3440	0.3427
R3	0.3376	0.3616
	0.3463	0.3687
	0.3451	0.3554
	0.3371	0.3490
R4	0.3463	0.3687
	0.3551	0.3760
	0.3533	0.3620
	0.3451	0.3554

Region	CIE x	CIE y
Q rank (5700 K)		
Q1	0.3215	0.3350
	0.3290	0.3417
	0.3290	0.3300
	0.3222	0.3243
Q2	0.3290	0.3417
	0.3371	0.3490
	0.3366	0.3369
	0.3290	0.3300
Q3	0.3207	0.3462
	0.3290	0.3538
	0.3290	0.3417
	0.3215	0.3350
Q4	0.3290	0.3538
	0.3376	0.3616
	0.3371	0.3490
	0.3290	0.3417

Region	CIE x	CIE y
P rank (6500 K)		
P1	0.3068	0.3113
	0.3144	0.3186
	0.3130	0.3290
	0.3048	0.3207
P2	0.3144	0.3186
	0.3221	0.3261
	0.3213	0.3373
	0.3130	0.3290
P3	0.3048	0.3207
	0.3130	0.3290
	0.3115	0.3391
	0.3028	0.3304
P4	0.3130	0.3290
	0.3213	0.3373
	0.3205	0.3481
	0.3115	0.3391

Note:

Samsung maintains measurement tolerance of: $C_x, C_y = \pm 0.005$

3. Typical Characteristics Graphs

a) Spectrum Distribution ($I_f = 150 \text{ mA}$, $T_s = 85 \text{ }^\circ\text{C}$)

Warm White

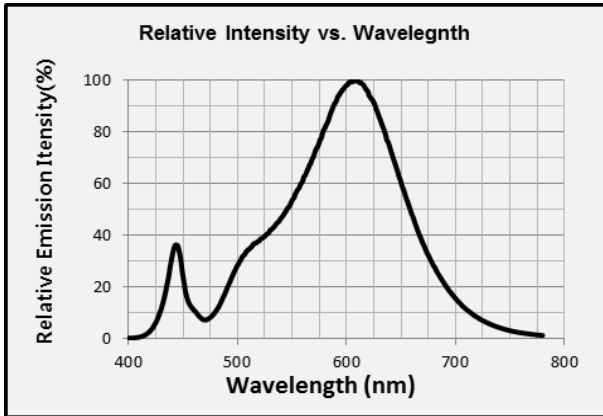

b) Forward Current Characteristics ($T_s = 85 \text{ }^\circ\text{C}$)

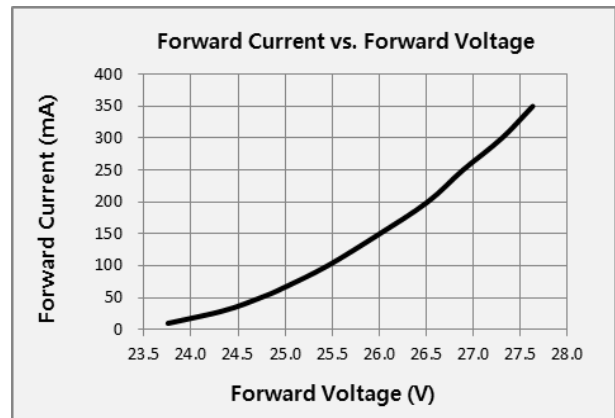
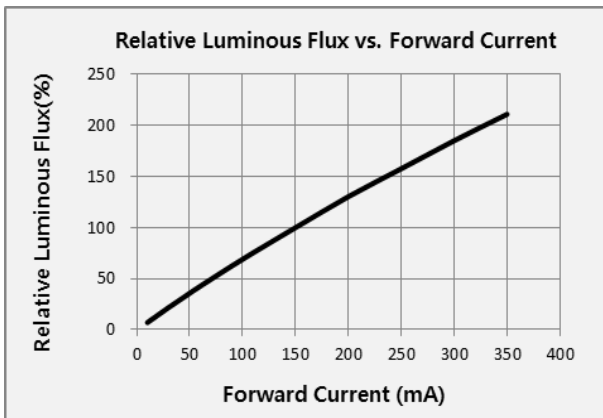

c) Temperature Characteristics ($I_f = 150 \text{ mA}$)

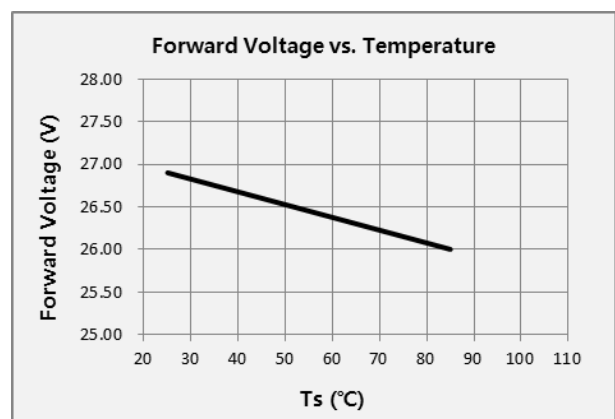
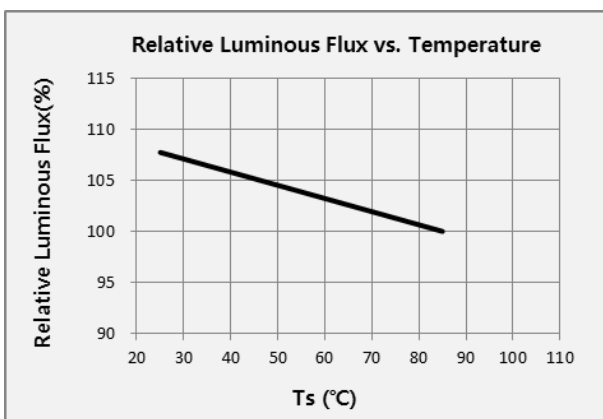

d) Color Shift Characteristics ($I_F = 150 \text{ mA}$, $T_s = 85 \text{ }^\circ\text{C}$)

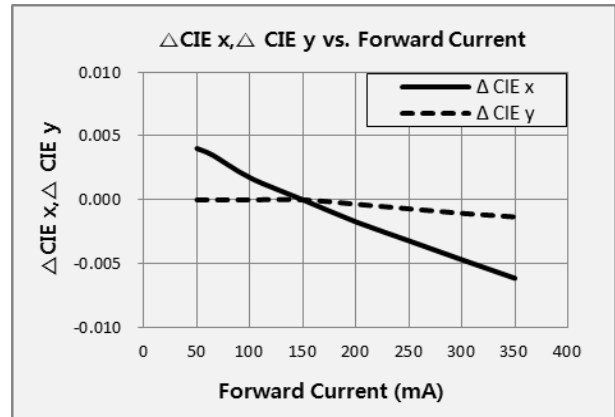
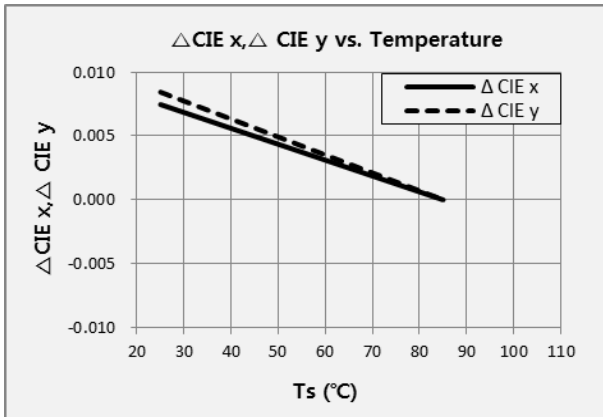

e) Derating Curve and Beam Angle Characteristics ($I_F = 150 \text{ mA}$, $T_s = 25 \text{ }^\circ\text{C}$)

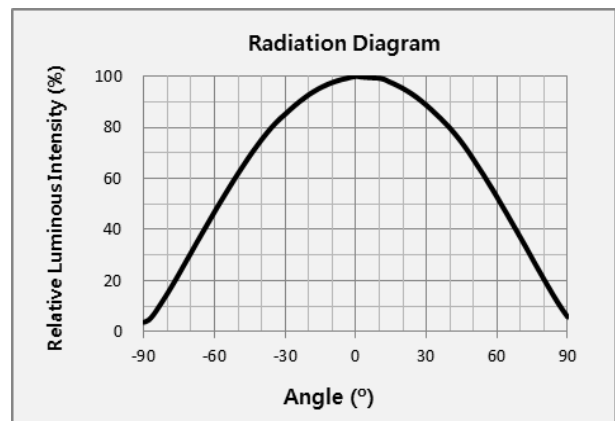
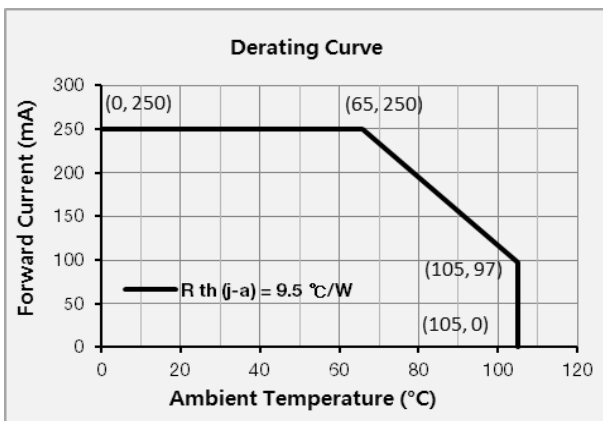

4. Outline Drawing & Dimension

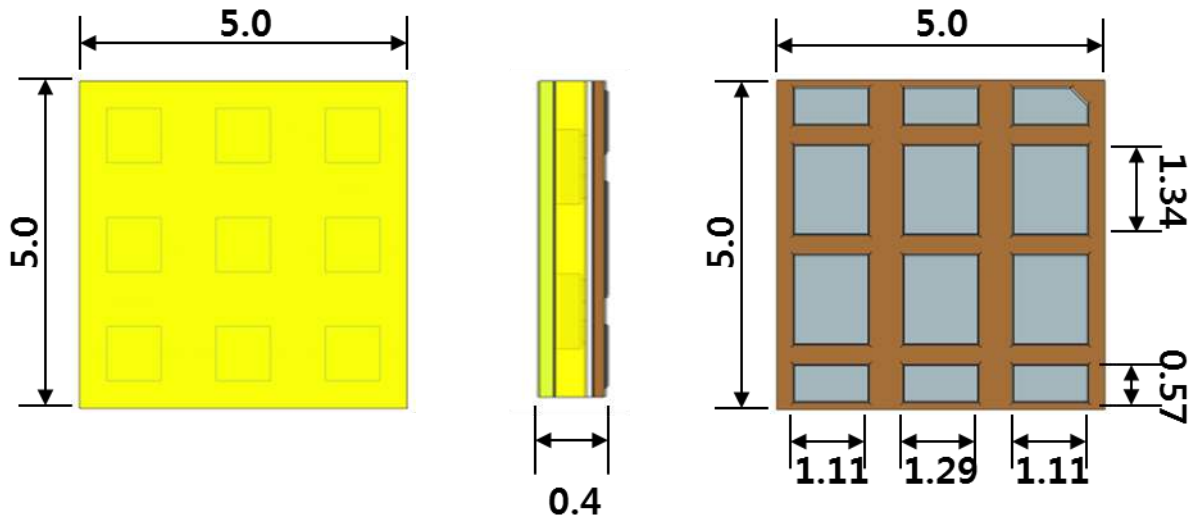

- Measurement unit: mm
- Maximum compressing force is 15 N on the body ③
- Do not place pressure on the encapsulation resin ④

Precautions:

- 1) Pressure on the LEDs will influence to the reliability of the LEDs. Precautions should be taken to avoid strong pressure on the LEDs. Do not put stress on the LEDs during heating.
- 2) Re-soldering should not be done after the LEDs have been soldered. If re-soldering is unavoidable, LED's characteristics should be carefully checked before and after such repair.
- 3) Do not stack assembled PCBs together. Since materials of LEDs is soft, abrasion between two PCB assembled with LED might cause catastrophic failure of the LEDs.

5. Reliability Test Items & Conditions

a) Test Items

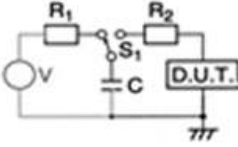
Test Item	Test Condition	Test Hour / Cycle	Sample No.	
Room Temperature Life Test	25 °C, Derating max current	1000 h	22	
High Temperature Life Test	85 °C, Derating max current	1000 h	22	
High Temperature Humidity Life Test	85 °C, 85 % RH, Derating max current	1000 h	22	
Low Temperature Life Test	-40 °C, Derating max current	1000 h	22	
Powered Temperature Cycle Test	-45 °C / 20 min ↔ 85 °C / 20 min, sweep 100 min cycle on/off: each 5 min, Derating max current	100 cycles	22	
Thermal Shock	-45 °C / 15 min ↔ 125 °C / 15 min → Hot plate 180 °C	500 cycles	100	
High Temperature Storage	120 °C	1000 h	11	
Low Temperature Storage	-40 °C	1000 h	11	
ESD (HBM)		R ₁ : 10 MΩ R ₂ : 1.5 kΩ C: 100 pF V: ±2 kV	5 times	30
ESD (MM)				
Vibration Test	20-2000-20 Hz, 200 m/s ² , sweep 4 min X, Y, Z 3 direction, each 1 cycle	4 cycles	11	
Mechanical Shock Test	1500 g, 0.5 ms 3 shocks each X-Y-Z axis	5 cycles	11	

b) Criteria for Judging the Damage

Item	Symbol	Test Condition (T _s = 25 °C)	Limit	
			Min	Max
Forward Voltage	V _F	I _F = 150 mA	Init. Value * 0.9	Init. Value * 1.1
Luminous Flux	Φ _v	I _F = 150 mA	Init. Value * 0.7	Init. Value * 1.1

6. Soldering Conditions

a) Reflow Conditions (Pb free)

Reflow frequency: 2 times max.

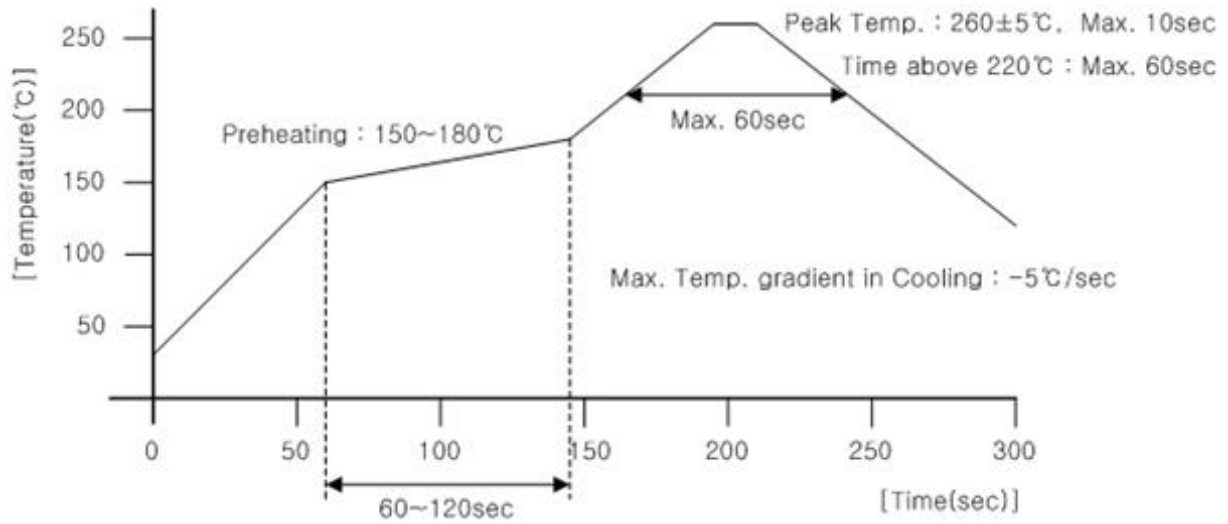

b) Manual Soldering Conditions

Not more than 5 seconds @ max. 300°C , under soldering iron.

7. Tape & Reel

a) Taping Dimension

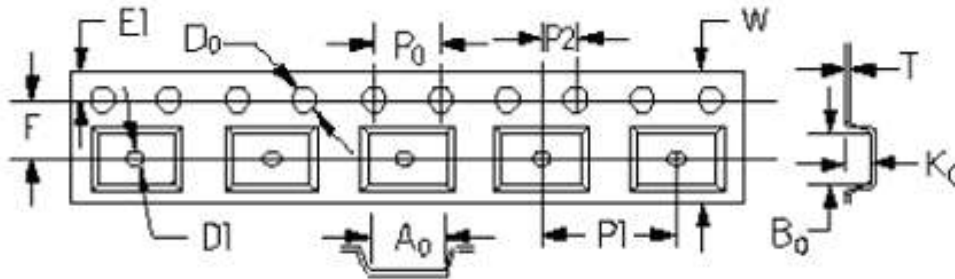

Ao	Bo	Ko	T	W	P1	E1	F	D0	D1	P2	Po	Po10
5.250	5.250	1.080	0.250	12.000	8.000	1.750	5.500	1.500	1.500	2.000	4.000	40.000

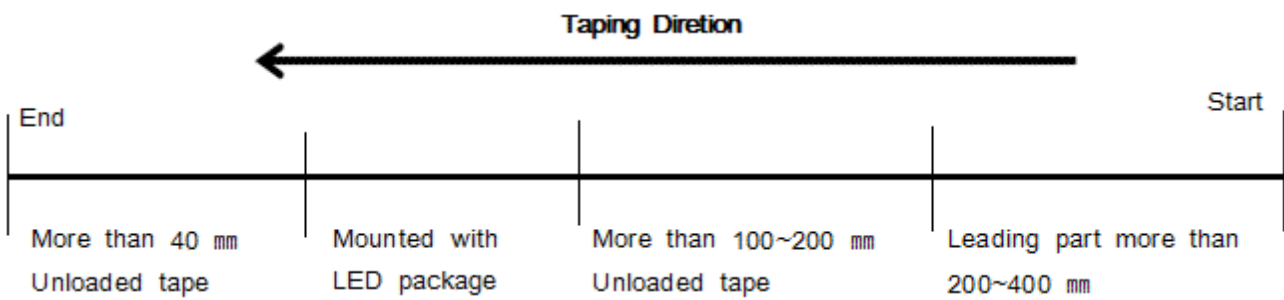

b) Reel Dimension

(unit: mm)

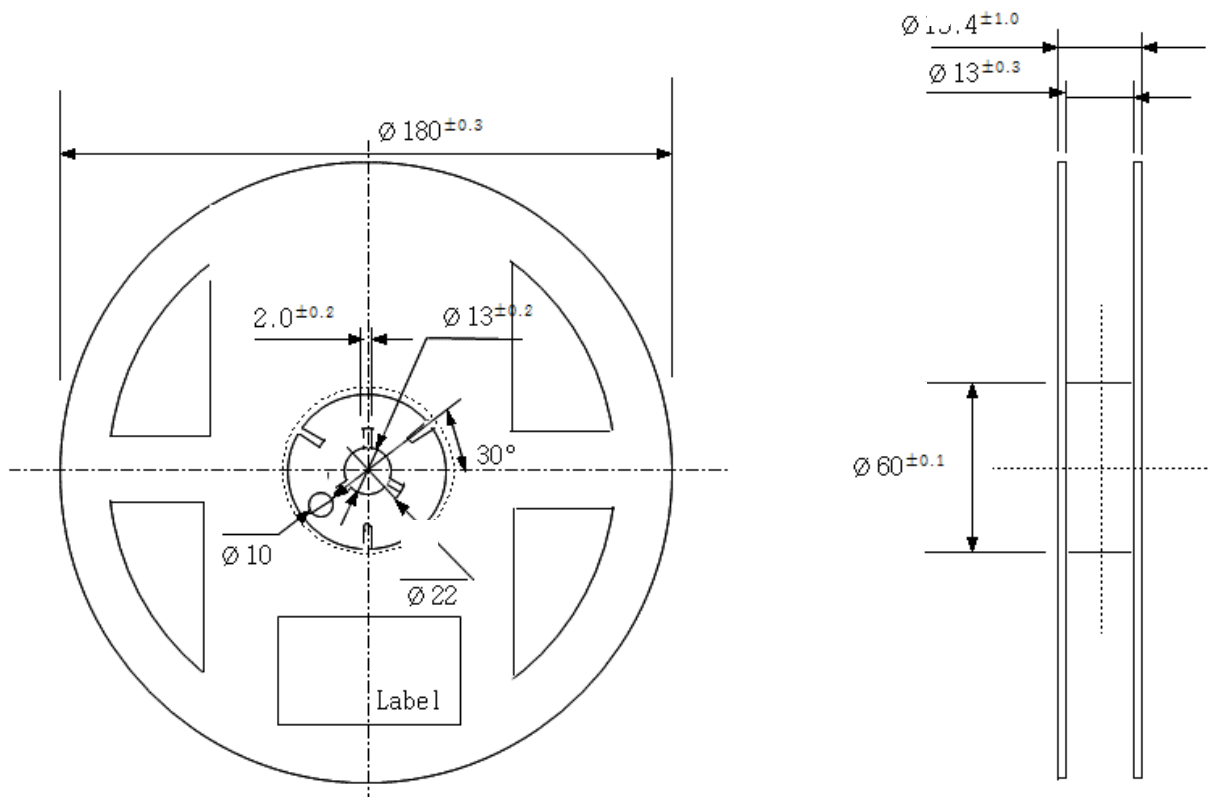
**Notes:**

- 1) Quantity: The quantity/reel is 1,000 pcs
- 2) Cumulative tolerance: Cumulative tolerance / 10 pitches is ± 0.2 mm
- 3) Adhesion strength of cover tape: Adhesion strength is 0.1-0.7 N when the cover tape is turned off from the carrier tape at 10° angle to the carrier tape
- 4) Packaging: P/N, Manufacturing data code no. and quantity are indicated on the aluminum packing bag

8. Label Structure

a) Label Structure

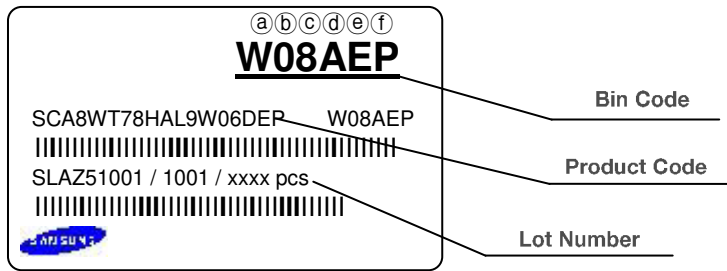

Note: Denoted bin code and product code above is only an example (see description on page 7)

Bin Code:

- ⒶⒷ: Forward Voltage bin (refer to page 10)
- ⒸⒹ: Chromaticity bin (refer to page 9)
- ⒺⒻ: Luminous Flux bin (refer to page 6-8)

b) Lot Number

The lot number is composed of the following characters:

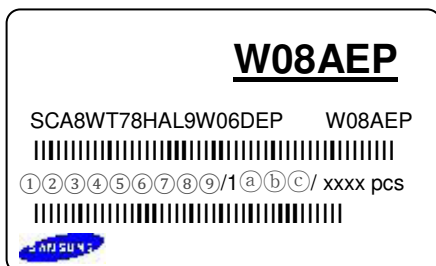

①②③④⑤⑥⑦⑧⑨ / 1ⒶⒷⒸ / xxxx pcs

- ① : Production site (S: Giheung, Korea)
- ② : L (LED)
- ③ : Product state (A: Normal, S: Sample)
- ④ : Year (A: 2016, B:2017, C:2018...)
- ⑤ : Month (1~9, A, B, C)
- ⑥ : Day (1~9, A, B~V)
- ⑦⑧⑨ : Product serial number (001 ~ 999)
- ⒶⒷⒸ : Reel number (001 ~ 999)

9. Packing Structure

a) Packing Process

Reel

W08AEP

SCA8WT78HAL9W06DEP W08AEP
 |||
 SLAZ51001 / 1001 / xxxx pcs
 |||

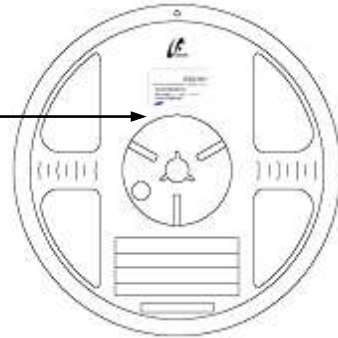
Aluminum Vinyl Packing Bag

W08AEP

SCA8WT78HAL9W06DEP W08AEP
 |||
 SLAZ51001 / 1001 / xxxx pcs
 |||





Outer Box

Material: PaperSW(B)

Type	Size (mm)			Note
	(a)	(b)	(c)	
7 inch	245 ± 5	220 ± 5	182 ± 5	Up to 7 reels

W08AEP

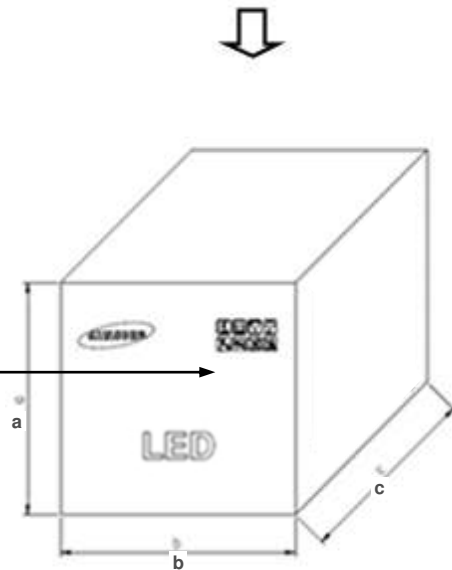
SCA8WT78HAL9W06DEP W08AEP
 |||
 SLAZ51001 / 1001 / xxxx pcs
 |||

b) Aluminum Vinyl Packing Bag



CAUTION
 This bag contains
MOISTURE SENSITIVE DEVICES

LEVEL
2a

1. Shelf life in sealed bag: 12 months at <40°C and <90% relative humidity (RH)
2. Peak package body temperature: 240 °C
3. After this bag is opened, devices that will be subjected to reflow solder or other high temperature processes must be:
 - a. Mounted within 672 hours at factory conditions of equal to or less than 30°C /60% RH, or
 - b. Stored at <10% RH
4. Devices require bake, before mounting, if:
 - a. Humidity Indicator Card is >65% when read at 23±5°C, or
 - b. 2a is not met.
5. If baking is required, devices must be baked for 1 hours at 60±5°C

Note: If device containers cannot be subjected to high temperature or shorter bake times are desired, reference IPC/JEDEC J-STD-033 for bake procedure.

Bag seal due date: _____
 (if blank, see code label)

Note: Level and body temperature by IPC/JEDEC J-STD-020

W08AEP

SCA8WT78HAL9W06DEP W08AEP
 |||||
 SLAZ5001 / 1001 / xxxx pcs
 |||||









ATTENTION
OBSERVE PRECAUTIONS
FOR HANDLING
ELECTROSTATIC
SENSITIVE
DEVICES



주의 사항

이 알루미늄 지퍼 팩은 습기 및 정전기로부터 제품을 보호하기 위하여 제작되었습니다. 개봉 후에는 즉시 솔더 작업을 실시하는 것을 권장합니다.

습기 및 정전기로부터 제품을 보호 하기 위해서 개봉 후 사용하지 않는 자재는 본 팩에 넣어 보관 하시기 바랍니다. 사용하지 않는 자재를 본 팩에 넣을 때는 반드시 동봉된 드라이 팩과 함께 넣고 지퍼부분을 완전하게 밀봉하여 주시기 바랍니다.

Important

This Al Zipper bag is designed to protect the enclosed products from moisture and ESD. Once opened, the products should be soldered onto the printed circuit board immediately. When not in use, please do not leave the products unprotected by the Al Zipper Bag. To repack unused products., please ensure the zip-lock is completely sealed with the dry pack left inside.

c) Silica Gel & Humidity Indicator Card inside Aluminum Vinyl Bag



DESICCANT
SILICA
DO NOT
GEL
SIL

HUMISAFE™

10% 20% 30% 40% 50% 60%



READ AT TOP OF GREEN COLOR
CHANGE BETWEEN YELLOW AND GREEN

Warning if Green
Change Desiccant

**HUMIDITY INDICATOR
COBALT-FREE**

GP&E Co., Ltd.
6CF-60NS

10. Precautions in Handling & Use

- 1) For over-current protection, users are recommended to apply resistors connected in series with the LEDs to mitigate sudden change of the forward current caused by shift of forward voltage.
- 2) This device should not be used in any type of fluid such as water, oil, organic solvent, etc. When cleaning is required, IPA is recommended as the cleaning agent. Some solvent-based cleaning agent may damage the silicone resins used in the device.
- 3) When the device is in operation, the forward current should be carefully determined considering the maximum ambient temperature and corresponding junction temperature.
- 4) LEDs must be stored in a clean environment. If the LEDs are to be stored for three months or more after being shipped from Samsung, they should be packed with a nitrogen-filled container (shelf life of sealed bags is 12 months at temperature 0~40 °C, 0~90 % RH).
- 5) After storage bag is opened, device subjected to soldering, solder reflow, or other high temperature processes must be:
 - a. Mounted within 672 hours (28 days) at an assembly line with a condition of no more than 30 °C / 60 % RH, or
 - b. Stored at <10 % RH
- 6) Repack unused devices with anti-moisture packing, fold to close any opening and then store in a dry place.
- 7) Devices require baking before mounting, if humidity card reading is >60 % at 23 ± 5 °C.
- 8) Devices must be baked for 1 hour at 60 ± 5 °C, if baking is required.
- 9) The LEDs are sensitive to the static electricity and surge current. It is recommended to use a wrist band or anti-electrostatic glove when handling the LEDs. If voltage exceeding the absolute maximum rating is applied to LEDs, it may cause damage or even destruction to LED devices. Damaged LEDs may show some unusual characteristics such as increase in leakage current, lowered turn-on voltage, or abnormal lighting of LEDs at low current.
- 10) VOCs (Volatile Organic Compounds) can be generated from adhesives, flux, hardener or organic additives used in luminaires (fixtures). Transparent LED silicone encapsulant is permeable to those chemicals and they may lead to a discoloration of encapsulant when they exposed to heat or light. This phenomenon can cause a significant loss of light emitted (output) from the luminaires. In order to prevent these problems, we recommend users to know the physical properties of materials used in luminaires and they must be carefully selected.
- 11) Risk of sulfurization (or tarnishing)

The LED from Samsung uses a silver-plated lead frame and its surface color may change to black (or dark colored) when it is exposed to sulfur (S), chlorine (Cl) or other halogen compound. Sulfurization of lead frame may cause intensity degradation, change of chromaticity coordinates and, in extreme cases, open circuit. It requires caution. Due to possible sulfurization of lead frame, LED should not be used and stored together with oxidizing substances made of materials such as rubber, plain paper, lead solder cream, etc.

Legal and additional information.

[About Samsung Electronics Co., Ltd.](#)

Samsung Electronics Co., Ltd. is a global leader in technology, opening new possibilities for people everywhere. Through relentless innovation and discovery, we are transforming the worlds of TVs, smartphones, tablets, PCs, cameras, home appliances, printers, LTE systems, medical devices, semiconductors and LED solutions. We employ 286,000 people across 80 countries with annual sales of US\$216.7 billion. To discover more, please visit www.samsungled.com.

Copyright © 2016 Samsung Electronics Co., Ltd. All rights reserved.
Samsung is a registered trademark of Samsung Electronics Co., Ltd.
Specifications and designs are subject to change without notice. Non-metric weights and measurements are approximate. All data were deemed correct at time of creation. Samsung is not liable for errors or omissions. All brand, product, service names and logos are trademarks and/or registered trademarks of their respective owners and are hereby recognized and acknowledged.

Samsung Electronics Co., Ltd.
1, Samsung-ro
Giheung-gu, Yongin-si
Gyeonggi-do, 17113
KOREA

www.samsungled.com

