

### Mini Top View LEDs EAPL3527BA4

PRELIMINARY



#### Features

- P-LCC-2 package.
- White package.
- Optical indicator.
- Colorless clear window.
- Wide viewing angle.
- Suitable for vapor-phase reflow, Infrared reflow and wave solder processes.
- Computable with automatic placement equipment.
- Available on tape and reel (8mm Tape).
- Pb-free.
- ESD protection.

#### Applications

- Telecommunication: indicator and backlighting in telephone and fax.
- Flat backlight for LCD, switch and symbol.
- Light pipe application.
- General use.

## Device Selection Guide

Chip Materials	Emitted Color	Resin Color
InGaN	Blue	Water Clear

## Absolute Maximum Ratings (Ta=25°C)

Parameter	Symbol	Rating	Unit
Reverse Voltage	V <sub>R</sub>	5	V
Forward Current	I <sub>F</sub>	25	mA
Peak Forward Current (Duty 1/10 @1KHz)	I <sub>FP</sub>	100	mA
Power Dissipation	P <sub>d</sub>	95	mW
Electrostatic Discharge(HBM)	ESD	2000	V
Operating Temperature	Topr	-40 ~ +85	°C
Storage Temperature	Tstg	-40 ~ +90	°C
Soldering Temperature	Tsol	Reflow Soldering : 260 °C for 10 sec. Hand Soldering : 350 °C for 3 sec.	

### Electro-Optical Characteristics (Ta=25°C)

Parameter	Symbol	Min.	Typ.	Max.	Unit	Condition
Luminous intensity	$I_v$	90	-----	225	mcd	$I_F=20mA$
Viewing Angle	$2\theta_{1/2}$	-----	120	-----	deg	$I_F=20mA$
Peak Wavelength	$\lambda_p$	-----	468	-----	nm	$I_F=20mA$
Dominant Wavelength	$\lambda_d$	464	----	472	nm	$I_F=20mA$
Spectrum Radiation Bandwidth	$\Delta \lambda$	-----	25	-----	nm	$I_F=20mA$
Forward Voltage	$V_F$	2.70	-----	3.50	V	$I_F=20mA$

Note:

1. Tolerance of Luminous Intensity:  $\pm 11\%$
2. Tolerance of Dominant Wavelength:  $\pm 1nm$
3. Tolerance of Forward Voltage:  $\pm 0.1V$

### Bin Range of Luminous Intensity

Bin	Min	Max	Unit	Condition
Q2	90	112	mcd	$I_F=20mA$
R1	112	140		
R2	140	180		
S1	180	225		

Note: Tolerance of Luminous Intensity:  $\pm 11\%$

### Bin Range of Dominant Wavelength

Group	Bin	Min	Max	Unit	Condition
F	AA1	464	466	nm	$I_F=20mA$
	AA2	466	468		
	AA3	468	470		
	AA4	470	472		

Note: Tolerance of Dominant Wavelength:  $\pm 1nm$

### Bin Rang of Forward Voltage

Group	Bin	Min	Max	Unit	Condition
F	10	2.70	2.90	V	I <sub>F</sub> =20mA
	11	2.90	3.10		
	12	3.10	3.30		
	13	3.30	3.50		

Note: Tolerance of Forward Voltage  $\pm 0.1V$

### Typical Electro-Optical Characteristics Curves

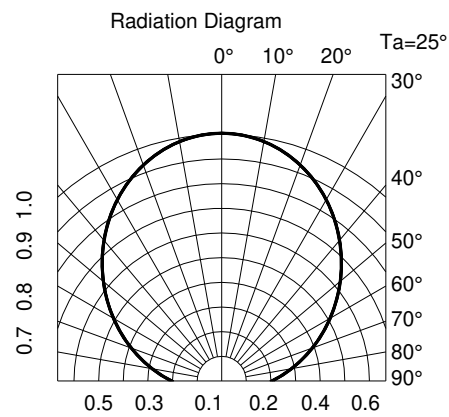
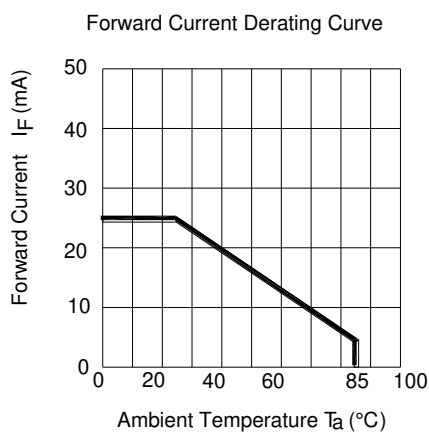
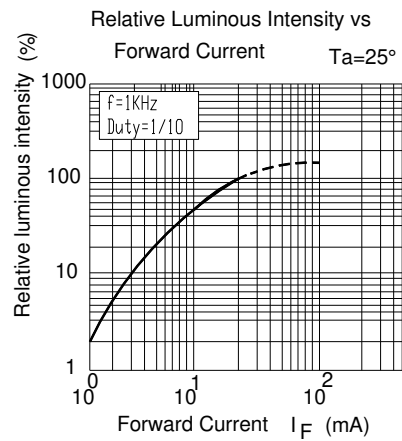
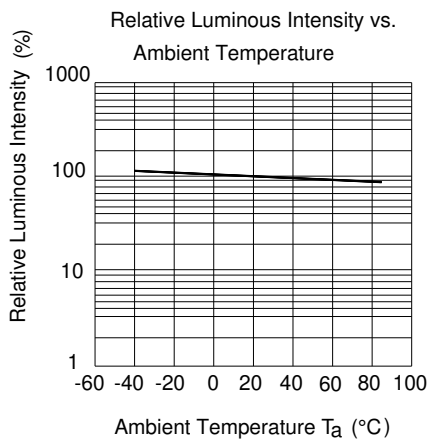
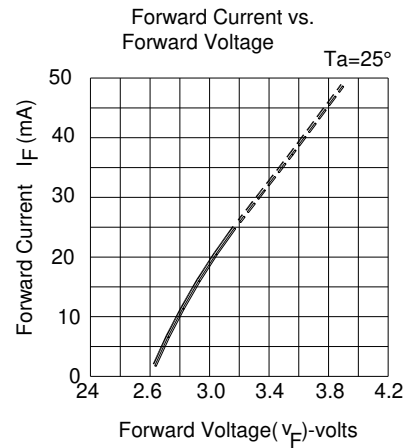
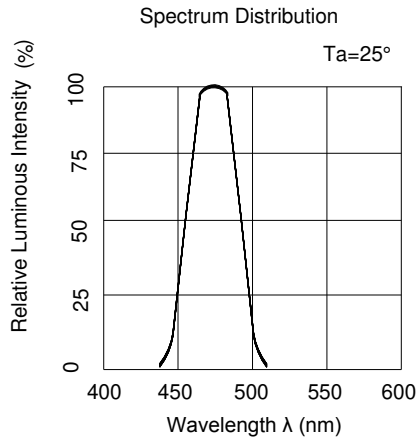

**Package Dimension**

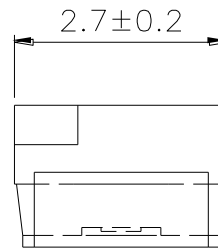
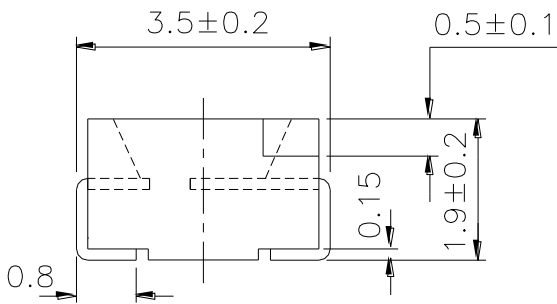
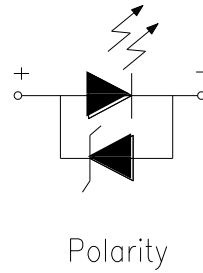
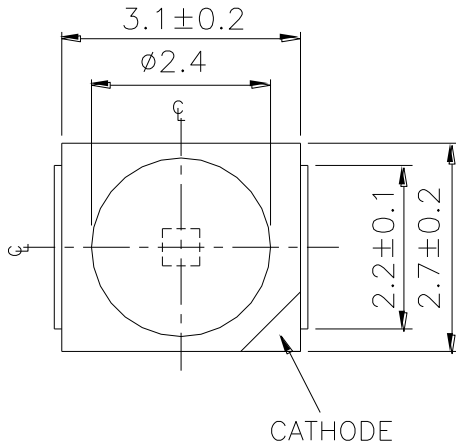

For reflow soldering (Proposal)

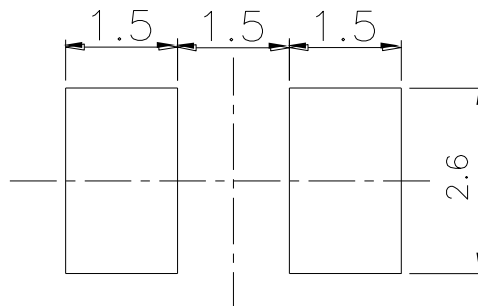
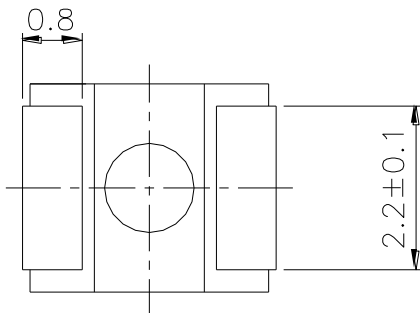

Note: Tolerances unless mentioned ±0.1mm. Unit = mm

## Moisture Resistant Packing Materials

### Label Explanation



- CPN: Customer's Product Number
- P/N: Product Number
- QTY: Packing Quantity
- CAT: Luminous Intensity Rank
- HUE: Dom. Wavelength Rank
- REF: Forward Voltage Rank
- LOT No: Lot Number

### Reel Dimensions

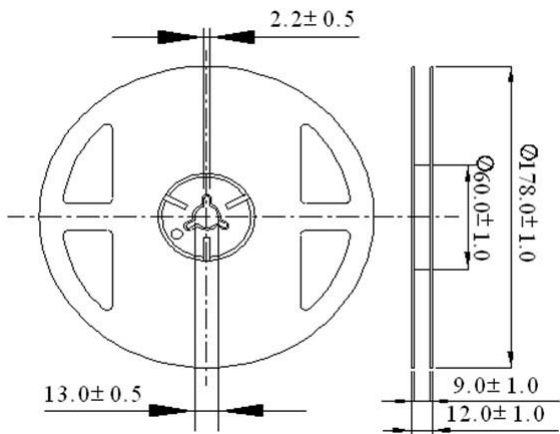

### Carrier Tape Dimensions: Loaded Quantity 2000 pcs Per Reel

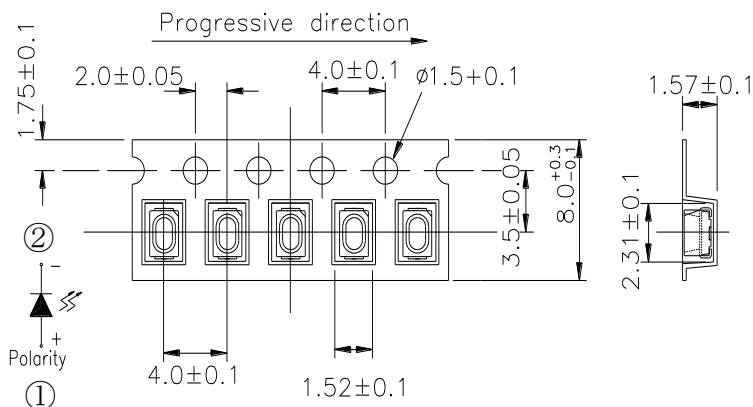

Note: Tolerances unless mentioned  $\pm 0.1$ mm. Unit = mm

### Moisture Resistant Packing Process

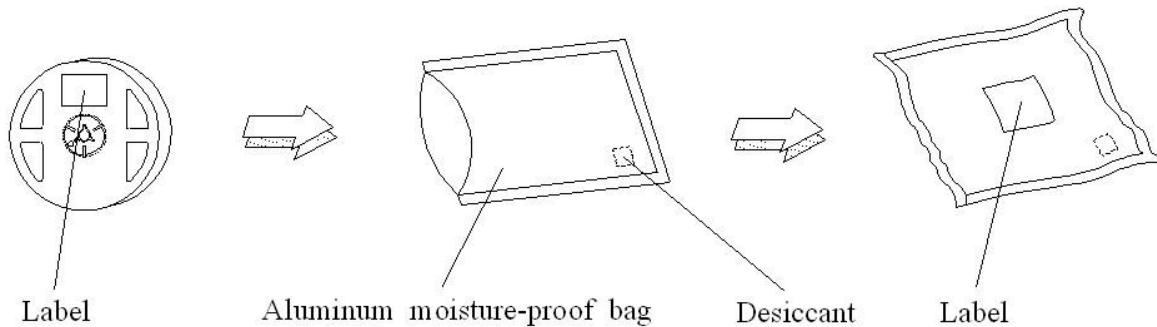

Note: Tolerances unless mentioned  $\pm 0.1\text{mm}$ . Unit = mm

### Precautions for Use

1. Over-current-proof  
Customer must apply resistors for protection; otherwise slight voltage shift will cause big current change (Burn out will happen).
2. Storage
  - 2.1 Do not open moisture proof bag before the products are ready to use.
  - 2.2 Before opening the package, the LEDs should be kept at  $30^{\circ}\text{C}$  or less and 90%RH or less.
  - 2.3 After opening the package: The LED's floor life are 168 hours under  $30^{\circ}\text{C}$  or less and 60% RH or less.  
If unused LEDs remain, it should be stored in moisture proof packages.
  - 2.4 If the moisture absorbent material (silica gel) has faded away or the LEDs have exceeded the storage time, baking treatment should be performed using the following conditions.  
Baking treatment :  $60\pm 5^{\circ}\text{C}$  for 24 hours.
3. Soldering Condition
  - 3.1 Pb-free solder temperature profile
  - 3.2 Reflow soldering should not be done more than two times.
  - 3.3 When soldering, do not put stress on the LEDs during heating.
  - 3.4 After soldering, do not warp the circuit board.

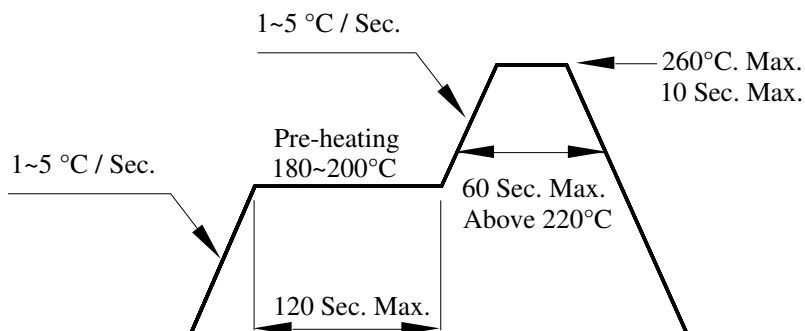



#### 4. Soldering Iron

Each terminal is to go to the tip of soldering iron temperature less than 280°C for 3 seconds within once in less than the soldering iron capacity 25W. Leave two seconds and more intervals, and do soldering of each terminal. Be careful because the damage of the product is often started at the time of the hand solder.

#### 5. Repairing

Repair should not be done after the LEDs have been soldered. When repairing is unavoidable, a double-head soldering iron should be used (as below figure). It should be confirmed beforehand whether the characteristics of the LEDs will or will not be damaged by repairing.

