

EXPAND 3 click™

2. Soldering the headers

Before using your click™ board, make sure to solder 1x8 male headers to both left and right side of the board. Two 1x8 male headers are included with the board in the package.

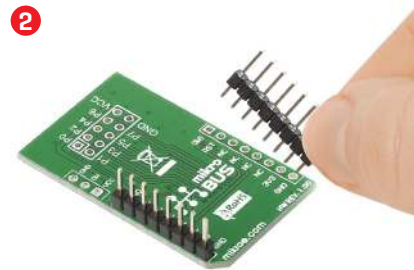
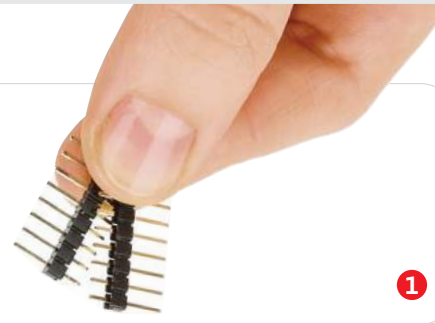

Turn the board upside down so that the bottom side is facing you upwards. Place shorter pins of the header into the appropriate soldering pads.



Turn the board upward again. Make sure to align the headers so that they are perpendicular to the board, then solder the pins carefully.

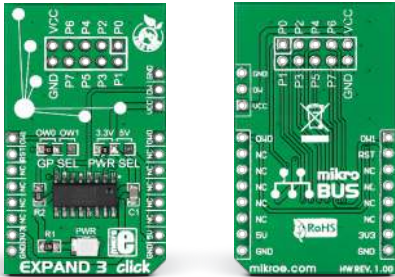

1. Introduction

EXPAND 3 click™ is an accessory board in mikroBUS™ form factor. It includes an **8-channel programmable I/O expander DS2408** that communicates with the target board MCU through a 1-Wire interface [15.3 kbps or 100kbps] The onboard GP SEL jumper allows you to specify the communication pins [either OW1 or OW0, which are in place of the usual AN and PWM pins on mikroBUS™]. An additional reset line [RST] is also connected. The board is designed to use either a 3.3V or 5V power supply.

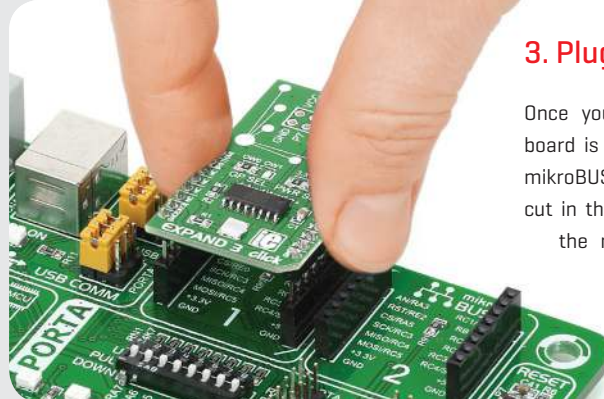

3. Plugging the board in

Once you have soldered the headers your board is ready to be placed into the desired mikroBUS™ socket. Make sure to align the cut in the lower-right part of the board with the markings on the silkscreen at the mikroBUS™ socket. If all the pins are aligned correctly, push the board all the way into the socket.

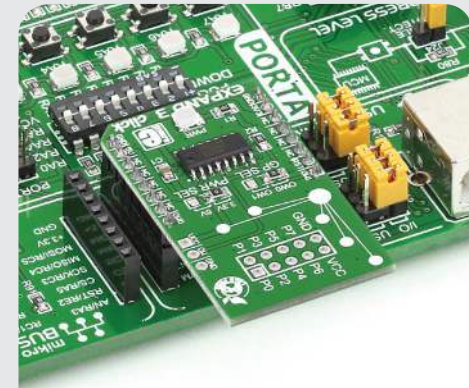

4. Essential features

Each DS2408 IC has a **factory-lasered 64-bit registration number**. Combined with the standard **Dallas Semiconductor 1-Wire protocol** it uses to communicate with the target board MCU, the registration number enables multiple devices to reside on the same data line, each one with a unique ID. To connect multiple Expand 3 clicks™, use the additional three pins positioned above the mikroBUS™ socket [VCC, OW, GND].

click™
BOARD
www.mikroe.com



EXPAND 3 click™ manual
ver 1.00



5. Schematic

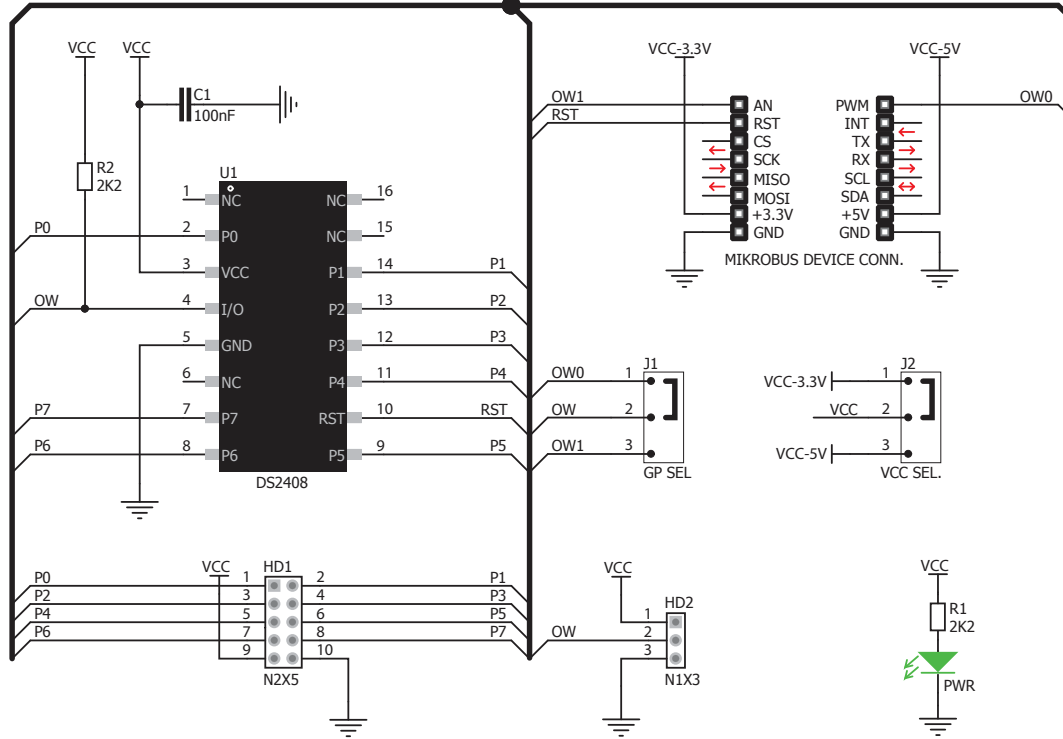

6. Dimensions

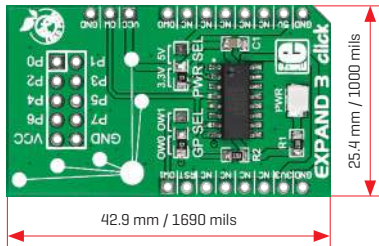

| | mm | mils |
|---------|------|------|
| LENGTH | 42.9 | 1690 |
| WIDTH | 25.4 | 1000 |
| HEIGHT* | 3.3 | 130 |

* without headers

7. SMD Jumper

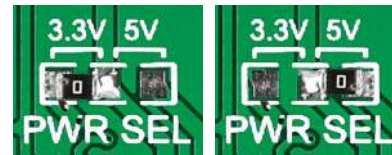

The board features a VCC SEL. Jumper [zero ohm resistor] that allows you to choose between a **3.3V or 5V power supply**. By default it's soldered in the 3.3V position.

8. Code examples

Once you have done all the necessary preparations, it's time to get your click™ board up and running. We have provided examples for mikroC™, mikroBasic™ and mikroPascal™ compilers on our **Libstock** website. Just download them and you are ready to start.



9. Support

MikroElektronika offers **free tech support** [www.mikroe.com/support] until the end of the product's lifetime, so if something goes wrong, we're ready and willing to help!



10. Disclaimer

MikroElektronika assumes no responsibility or liability for any errors or inaccuracies that may appear in the present document. Specification and information contained in the present schematic are subject to change at any time without notice.

Copyright © 2015 MikroElektronika.
All rights reserved.