

DS90CR211/DS90CR212 21-Bit Channel Link

General Description

The DS90CR211 transmitter converts 21 bits of CMOS/TTL data into three LVDS (Low Voltage Differential Signaling) data streams. A phase-locked transmit clock is transmitted in parallel with the data streams over a fourth LVDS link. Every cycle of the transmit clock 21 bits of input data are sampled and transmitted. The DS90CR212 receiver converts the LVDS data streams back into 21 bits of CMOS/TTL data. At a transmit clock frequency of 40 MHz, 21 bits of TTL data are transmitted at a rate of 280 Mbps per LVDS data channel. Using a 40 MHz clock, the data throughput is 840 Mbit/s (105 Mbyte/s).

The multiplexing of the data lines provides a substantial cable reduction. Long distance parallel single-ended buses typically require a ground wire per active signal (and have very limited noise rejection capability). Thus, for a 21-bit wide data bus and one clock, up to 44 conductors are required. With the Channel Link chipset as few as 9 conductors (3 data pairs, 1 clock pair and a minimum of one ground) are

needed. This provides a 80% reduction in required cable width, providing a system cost savings, reduces connector physical size, and reduces shielding requirements due to the cables smaller form factor.

The 21 CMOS/TTL inputs can support a variety of signal combinations. For example, 5 4-bit nibbles plus 1 control, or 2 9-bit (byte + parity) and 3 control.

Features

- Narrow bus reduces cable size and cost
- $\pm 1V$ Common mode range (ground shifting)
- 290 mV swing LVDS data transmission
- 840 Mbit/s data throughput
- Low swing differential current mode drivers reduce EMI
- Rising edge data strobe
- Power down mode
- Offered in low profile 48-lead TSSOP package

Block Diagrams

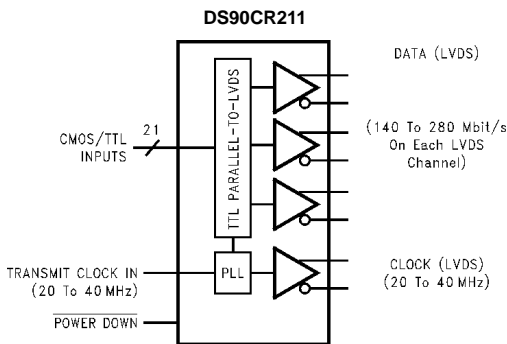

Order Number DS90CR211MTD
See NS Package Number MTD48

DS012637-27

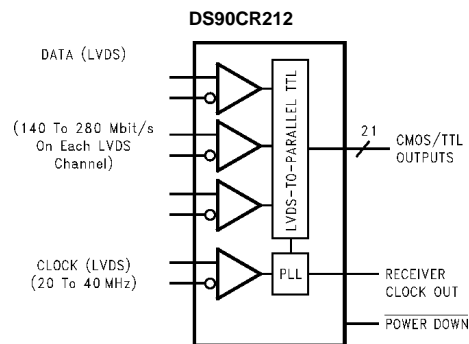

Order Number DS90CR212MTD
See NS Package Number MTD48

DS012637-1

Connection Diagrams

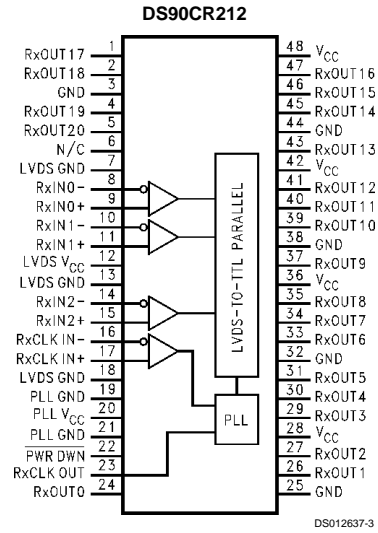
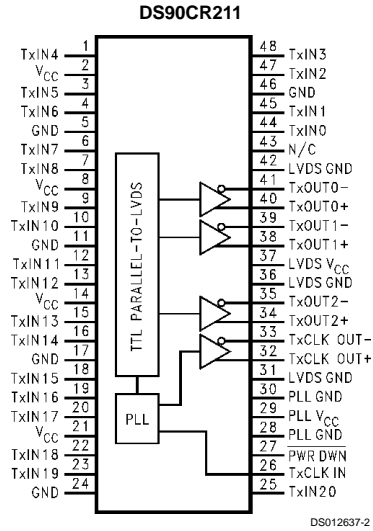

Typical Application

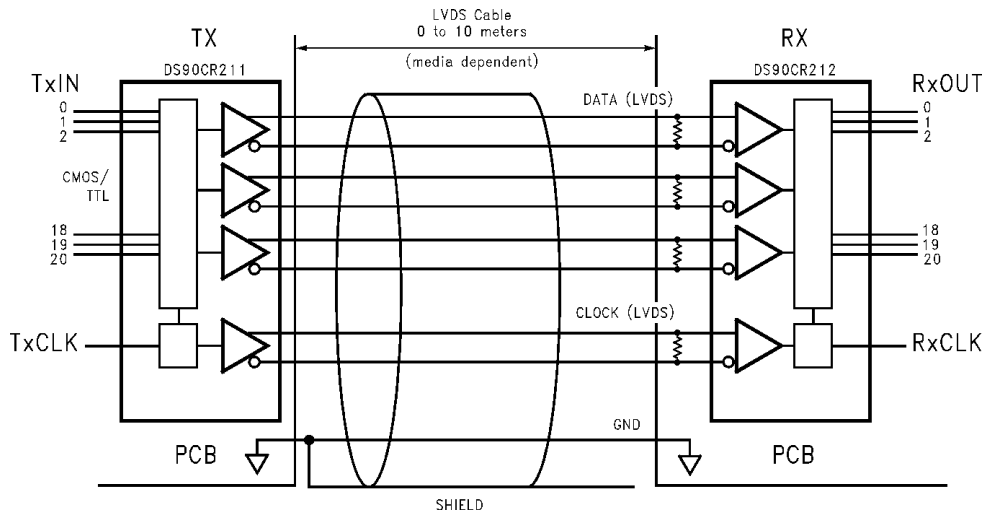

Absolute Maximum Ratings (Note 1)

If Military/Aerospace specified devices are required, please contact the National Semiconductor Sales Office/Distributors for availability and specifications.

Supply Voltage (V_{CC})	-0.3V to +6V
CMOS/TTL Input Voltage	-0.3V to ($V_{CC} + 0.3V$)
CMOS/TTL Output Voltage	-0.3V to ($V_{CC} + 0.3V$)
LVDS Receiver Input Voltage	-0.3V to ($V_{CC} + 0.3V$)
LVDS Driver Output Voltage	-0.3V to ($V_{CC} + 0.3V$)
LVDS Output	
Short Circuit Duration	continuous
Junction Temperature	+150°C
Storage Temperature Range	-65°C to +150°C
Lead Temperature (Soldering, 4 sec.)	+260°C
Maximum Power Dissipation @ +25°C	

MTD48 (TSSOP) Package:

DS90CR211	1.98W
DS90CR212	1.89W

Package Derating:

DS90CR211	16 mW/°C above +25°C
DS90CR212	15 mW/°C above +25°C

This device does not meet 2000V ESD rating (Note 4).

Recommended Operating Conditions

	Min	Max	Units
Supply Voltage (V_{CC})	4.5	5.5	V
Operating Free Air Temperature (T_A)	-10	+70	°C
Receiver Input Range	0	2.4	V
Supply Noise Voltage (V_{CC})		100	mV _{PP}

Electrical Characteristics

Over recommended operating supply and temperature ranges unless otherwise specified

Symbol	Parameter	Conditions	Min	Typ	Max	Units	
CMOS/TTL DC SPECIFICATIONS							
V_{IH}	High Level Input Voltage		2.0		V_{CC}	V	
V_{IL}	Low Level Input Voltage		GND		0.8	V	
V_{OH}	High Level Output Voltage	$I_{OH} = -0.4$ mA	3.8	4.9		V	
V_{OL}	Low Level Output Voltage	$I_{OL} = 2$ mA		0.1	0.3	V	
V_{CL}	Input Clamp Voltage	$I_{CL} = -18$ mA		-0.79	-1.5	V	
I_{IN}	Input Current	$V_{IN} = V_{CC}, GND, 2.5V$ or 0.4V		±5.1	±10	µA	
I_{OS}	Output Short Circuit Current	$V_{OUT} = 0V$			-120	mA	
LVDS DRIVER DC SPECIFICATIONS							
V_{OD}	Differential Output Voltage	$R_L = 100\Omega$	250	290	450	mV	
ΔV_{OD}	Change in V_{OD} between Complementary Output States				35	mV	
V_{CM}	Common Mode Voltage		1.1	1.25	1.375	V	
ΔV_{CM}	Change in V_{CM} between Complementary Output States				35	mV	
I_{OS}	Output Short Circuit Current	$V_{OUT} = 0V, R_L = 100\Omega$		-2.9	-5	mA	
I_{OZ}	Output TRI-STATE® Current	Power Down = 0V, $V_{OUT} = 0V$ or V_{CC}		±1	±10	µA	
LVDS RECEIVER DC SPECIFICATIONS							
V_{TH}	Differential Input High Threshold	$V_{CM} = +1.2V$			+100	mV	
V_{TL}	Differential Input Low Threshold		-100			mV	
I_{IN}	Input Current	$V_{IN} = +2.4V$	$V_{CC} = 5.5V$		< ±1	±10	µA
		$V_{IN} = 0V$			< ±1	±10	µA
TRANSMITTER SUPPLY CURRENT							
I_{CCTW}	Transmitter Supply Current, Worst Case	$R_L = 100\Omega, C_L = 5$ pF, Worst Case Pattern (Figure 1, Figure 2)	$f = 32.5$ MHz		34	51	mA
			$f = 37.5$ MHz		36	53	mA
I_{CCTZ}	Transmitter Supply Current, Power Down	Power Down = Low			1	25	µA
RECEIVER SUPPLY CURRENT							
I_{CCRW}	Receiver Supply Current, Worst Case	$C_L = 8$ pF, Worst Case Pattern (Figure 1, Figure 3)	$f = 32.5$ MHz		55	75	mA
			$f = 37.5$ MHz		60	80	mA

Electrical Characteristics (Continued)

Over recommended operating supply and temperature ranges unless otherwise specified

Symbol	Parameter	Conditions	Min	Typ	Max	Units
RECEIVER SUPPLY CURRENT						
I_{CCRZ}	Receiver Supply Current, Power Down	Power Down = Low		1	10	μ A

Note 1: "Absolute Maximum Ratings" are those values beyond which the safety of the device cannot be guaranteed. They are not meant to imply that the device should be operated at these limits. The tables of "Electrical Characteristics" specify conditions for device operation.

Note 2: Typical values are given for $V_{CC} = 5.0V$ and $T_A = +25^\circ C$.

Note 3: Current into device pins is defined as positive. Current out of device pins is defined as negative. Voltages are referenced to ground unless otherwise specified (except V_{OD} and ΔV_{OD}).

Note 4: ESD Rating:

HBM (1.5 k Ω , 100 pF)

PLL $V_{CC} \geq 1000V$

All other pins $\geq 2000V$

EIAJ (0 Ω , 200 pF) $\geq 150V$

Transmitter Switching Characteristics

Over recommended operating supply and temperature ranges unless otherwise specified

Symbol	Parameter	Min	Typ	Max	Units	
LLHT	LVDS Low-to-High Transition Time (Figure 2)		0.75	1.5	ns	
LHLT	LVDS High-to-Low Transition Time (Figure 2)		0.75	1.5	ns	
TCIT	TxCLK IN Transition Time (Figure 4)			8	ns	
TCCS	TxOUT Channel-to-Channel Skew (Note 5) (Figure 5)			350	ps	
TPPos0	Transmitter Output Pulse Position for Bit0 (Figure 16)	f = 20 MHz	-200	150	350	ps
TPPos1	Transmitter Output Pulse Position for Bit1		6.3	7.2	7.5	ns
TPPos2	Transmitter Output Pulse Position for Bit2		12.8	13.6	14.6	ns
TPPos3	Transmitter Output Pulse Position for Bit3		20	20.8	21.5	ns
TPPos4	Transmitter Output Pulse Position for Bit4		27.2	28	28.5	ns
TPPos5	Transmitter Output Pulse Position for Bit5		34.5	35.2	35.6	ns
TPPos6	Transmitter Output Pulse Position for Bit6		42.2	42.6	42.9	ns
TPPos0	Transmitter Output Pulse Position for Bit0 (Figure 16)	f = 40 MHz	-100	100	300	ps
TPPos1	Transmitter Output Pulse Position for Bit1		2.9	3.3	3.9	ns
TPPos2	Transmitter Output Pulse Position for Bit2		6.1	6.6	7.1	ns
TPPos3	Transmitter Output Pulse Position for Bit3		9.7	10.2	10.7	ns
TPPos4	Transmitter Output Pulse Position for Bit4		13	13.5	14.1	ns
TPPos5	Transmitter Output Pulse Position for Bit5		17	17.4	17.8	ns
TPPos6	Transmitter Output Pulse Position for Bit6		20.3	20.8	21.4	ns
TCIP	TxCLK IN Period (Figure 6)	25	T	50	ns	
TCIH	TxCLK IN High Time (Figure 6)	0.35T	0.5T	0.65T	ns	
TCIL	TxCLK IN Low Time (Figure 6)	0.35T	0.5T	0.65T	ns	
TSTC	TxIN Setup to TxCLK IN (Figure 6)	f = 20 MHz	14			ns
		f = 40 MHz	8			ns
THTC	TxIN Hold to TxCLK IN (Figure 6)	2.5	2		ns	
TCCD	TxCLK IN to TxCLK OUT Delay @ 25°C, $V_{CC} = 5.0V$ (Figure 8)	5		9.7	ns	
TPLLS	Transmitter Phase Lock Loop Set (Figure 10)			10	ms	
TPDD	Transmitter Powerdown Delay (Figure 14)			100	ns	

Note 5: This limit based on bench characterization.

Receiver Switching Characteristics

Over recommended operating supply and temperature ranges unless otherwise specified

Symbol	Parameter	Min	Typ	Max	Units
CLHT	CMOS/TTL Low-to-High Transition Time (Figure 3)		3.5	6.5	ns
CHLT	CMOS/TTL High-to-Low Transition Time (Figure 3)		2.7	6.5	ns
RCOP	RxCLK OUT Period (Figure 7)	25	T	50	ns
RSKM	Receiver Skew Margin (Note 6) $V_{CC} = 5V, T_A = 25^\circ C$ (Figure 17)	f = 20 MHz	1.1		ns
		f = 40 MHz	700		ps
RCOH	RxCLK OUT High Time (Figure 7)	f = 20 MHz	19		ns
		f = 40 MHz	6		ns
RCOL	RxCLK OUT Low Time (Figure 7)	f = 20 MHz	21.5		ns
		f = 40 MHz	10.5		ns
RSRC	RxCLK Setup to RxCLK OUT (Figure 7)	f = 20 MHz	14		ns
		f = 40 MHz	4.5		ns
RHRC	RxCLK Hold to RxCLK OUT (Figure 7)	f = 20 MHz	16		ns
		f = 40 MHz	6.5		ns
RCCD	RxCLK IN to RxCLK OUT Delay @ 25°C, $V_{CC} = 5.0V$ (Figure 9)	7.6		11.9	ns
RPLLS	Receiver Phase Lock Loop Set (Figure 11)			10	ms
RPDD	Receiver Powerdown Delay (Figure 15)			1	μs

Note 6: Receiver Skew Margin is defined as the valid data sampling region at the receiver inputs. This margin takes into account for transmitter output skew (TCCS) and the setup and hold time (internal data sampling window), allowing LVDS cable skew dependent on type/length and source clock (TxCLK IN) jitter.
 $RSKM \geq \text{cable skew (type, length)} + \text{source clock jitter (cycle to cycle)}$.

AC Timing Diagrams

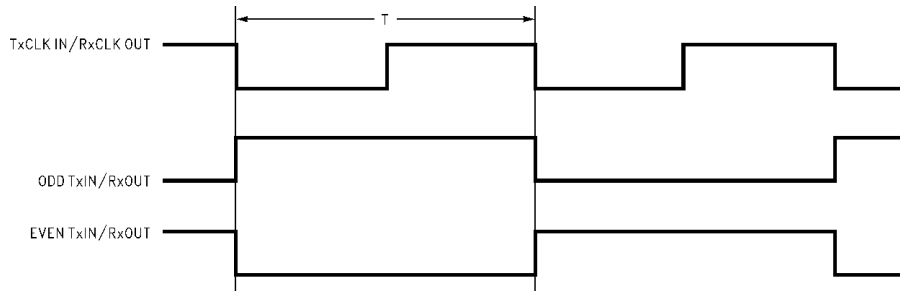

FIGURE 1. "WORST CASE" Test Pattern

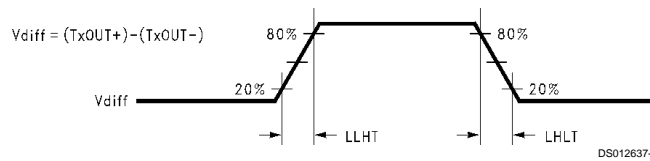
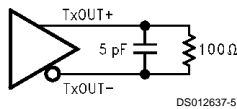

FIGURE 2. DS90CR211 (Transmitter) LVDS Output Load and Transition Timing

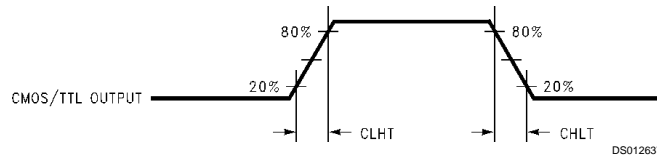
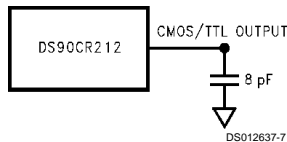

FIGURE 3. DS90CR212 (Receiver) CMOS/TTL Output Load and Transition Timing

AC Timing Diagrams (Continued)

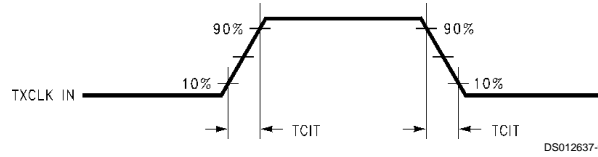
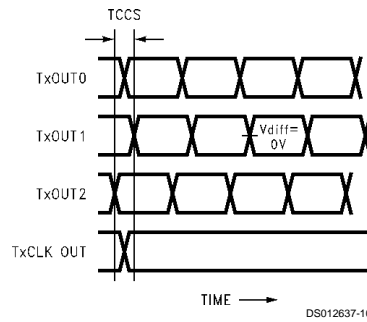

FIGURE 4. DS90CR211 (Transmitter) Input Clock Transition Time



Measurements at $V_{diff} = 0V$
 TCCS measured between earliest and latest initial LVDS edges.
 TxCLK OUT Differential Low→High Edge

FIGURE 5. DS90CR211 (Transmitter) Channel-to-Channel Skew and Pulse Width

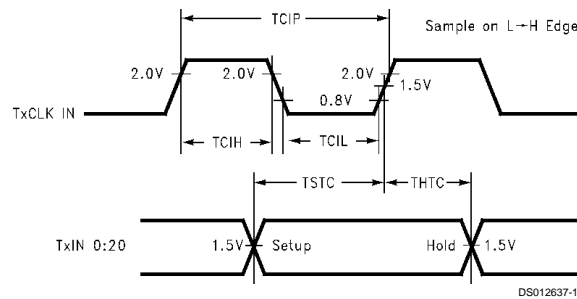

FIGURE 6. DS90CR211 Setup/Hold and High/Low Times

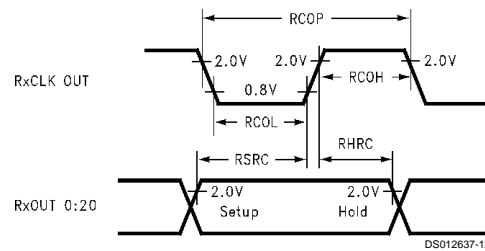

FIGURE 7. DS90CR212 Setup/Hold and High/Low Times

AC Timing Diagrams (Continued)

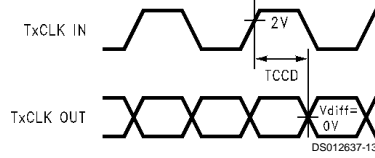

FIGURE 8. DS90CR211 (Transmitter) Clock In to Clock Out Delay

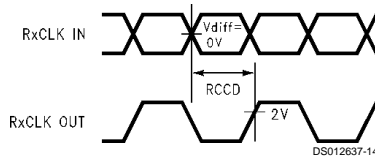

FIGURE 9. DS90CR212 (Receiver) Clock In to Clock Out Delay

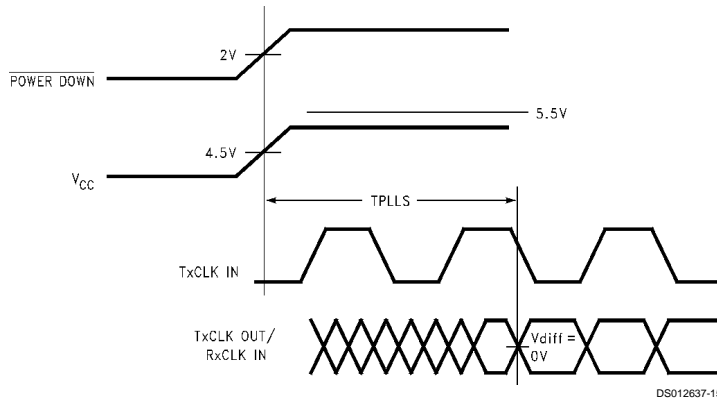

FIGURE 10. DS90CR211 (Transmitter) Phase Lock Loop Set Time

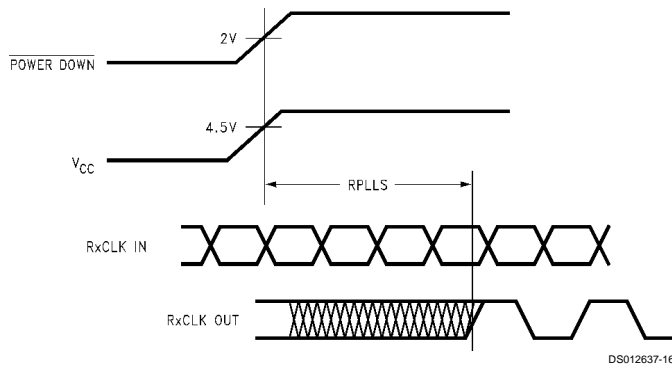

FIGURE 11. DS90CR212 (Receiver) Phase Lock Loop Set Time

AC Timing Diagrams (Continued)

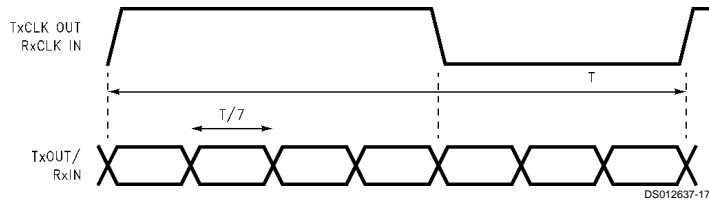

FIGURE 12. Seven Bits of LVDS in One Clock Cycle

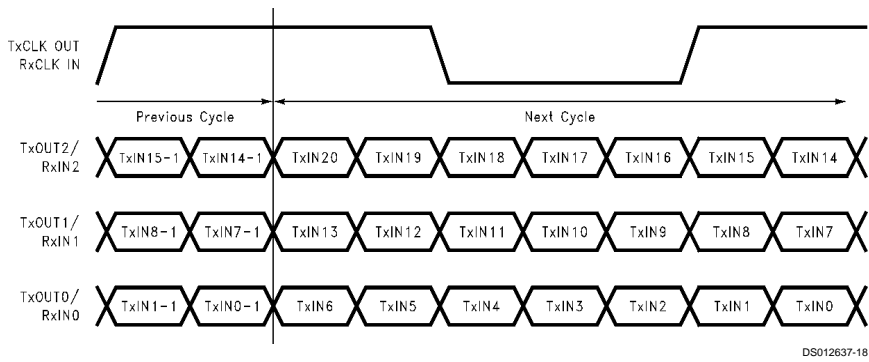

FIGURE 13. 21 Parallel TTL Data Inputs Mapped to LVDS Outputs (DS90CR211)

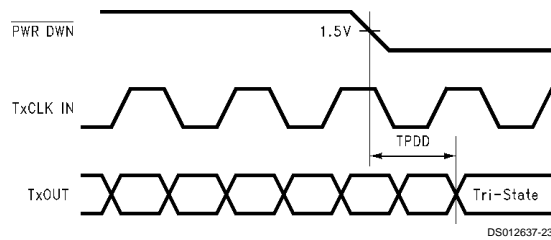

FIGURE 14. Transmitter Powerdown Delay

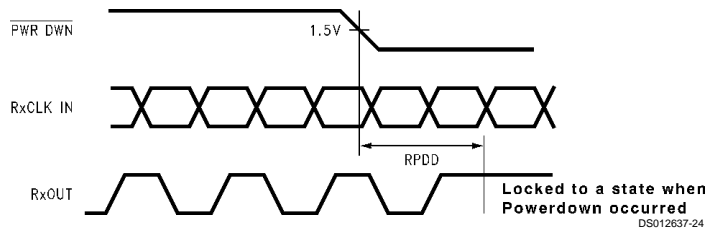
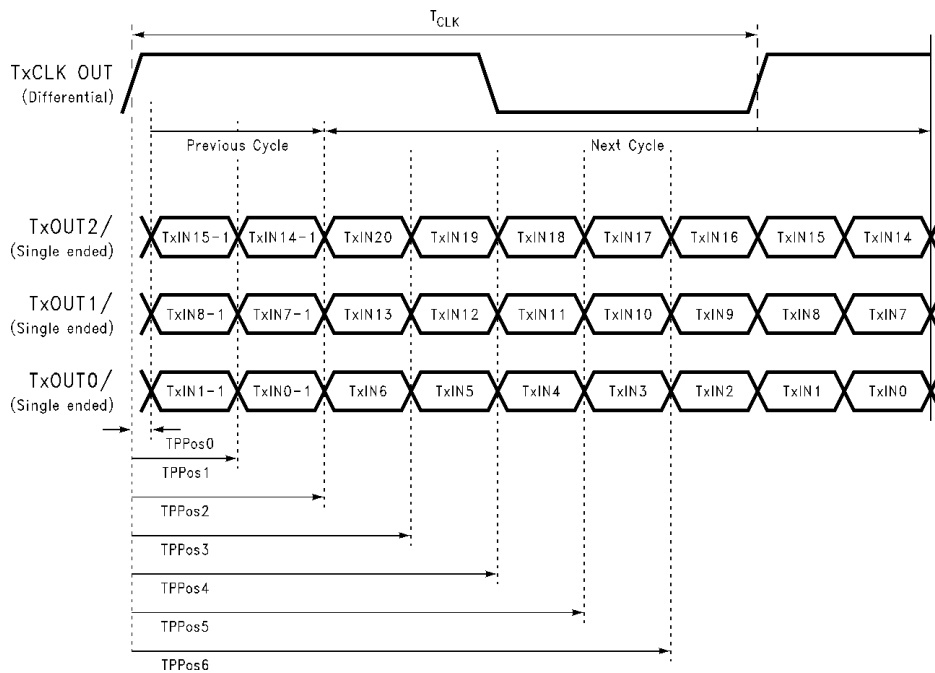

FIGURE 15. Receiver Powerdown Delay

AC Timing Diagrams (Continued)



DS012637-25

FIGURE 16. Transmitter LVDS Output Pulse Position Measurement

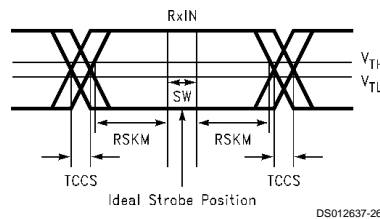

DS012637-26

SW — Setup and Hold Time (Internal data sampling window)
 TCCS — Transmitter Output Skew
 $RSKM \geq \text{Cable Skew (type, length) + Source Clock Jitter (cycle to cycle)}$
 Cable Skew — Typically 10 ps–40 ps per foot

FIGURE 17. Receiver LVDS Input Skew Margin

DS90CR211 Pin Description— Channel Link Transmitter (Tx)

Pin Name	I/O	No.	Description
TxIN	I	21	TTL Level inputs
TxOUT+	O	3	Positive LVDS differential data output
TxOUT-	O	3	Negative LVDS differential data output
TxCLK IN	I	1	TTL level clock input. The rising edge acts as data strobe
TxCLK OUT+	O	1	Positive LVDS differential clock output
TxCLK OUT-	O	1	Negative LVDS differential clock output
PWR DOWN	I	1	TTL level input. Assertion (low input) TRI-STATES the outputs, ensuring low current at power down
V _{CC}	I	4	Power supply pins for TTL inputs
GND	I	5	Ground pins for TTL inputs

DS90CR211 Pin Description— Channel Link Transmitter (Tx) (Continued)

Pin Name	I/O	No.	Description
PLL V _{CC}	I	1	Power supply pin for PLL
PLL GND	I	2	Ground pins for PLL
LVDS V _{CC}	I	1	Power supply pin for LVDS outputs
LVDS GND	I	3	Ground pins for LVDS outputs

DS90CR212 Pin Description— Channel Link Receiver (Rx)

Pin Name	I/O	No.	Description
RxIN+	I	3	Positive LVDS differential data inputs
RxIN-	I	3	Negative LVDS differential data inputs
RxOUT	O	21	TTL level outputs
RxCLK IN+	I	1	Positive LVDS differential clock input
RxCLK IN-	I	1	Negative LVDS differential clock input
RxCLK OUT	O	1	TTL level clock output. The rising edge acts as data strobe
PWR DOWN	I	1	TTL level input. Assertion (low input) maintains the receiver outputs in the previous state
V _{CC}	I	4	Power supply pins for TTL outputs
GND	I	5	Ground pins for TTL outputs
PLL V _{CC}	I	1	Power supply for PLL
PLL GND	I	2	Ground pin for PLL
LVDS V _{CC}	I	1	Power supply pin for LVDS inputs
LVDS GND	I	3	Ground pins for LVDS inputs

Applications Information

The Channel Link devices are intended to be used in a wide variety of data transmission applications. Depending upon the application the interconnecting media may vary. For example, for lower data rate (clock rate) and shorter cable lengths (< 2m), the media electrical performance is less critical. For higher speed/long distance applications the media's performance becomes more critical. Certain cable constructions provide tighter skew (matched electrical length between the conductors and pairs). Twin-coax for example, has been demonstrated at distances as great as 10 meters and with the maximum data transfer of 1.12 Gbit/s. Additional applications information can be found in the following National Interface Application Notes:

AN = ####	Topic
AN-1035	PCB Design Guidelines for LVDS and Link Devices
AN-806	Transmission Line Theory
AN-905	Transmission Line Calculations and Differential Impedance
AN-916	Cable Information

CABLES: A cable interface between the transmitter and receiver needs to support the differential LVDS pairs. The 21-bit CHANNEL LINK chipset (DS90CR211/212) requires four pairs of signal wires and the 28-bit CHANNEL LINK chipset (DS90CR281/282) requires five pairs of signal wires. The ideal cable/connector interface would have a constant 100Ω differential impedance throughout the path. It is also recommended that cable skew remain below 350 ps (@ 40 MHz clock rate) to maintain a sufficient data sampling window at the receiver.

In addition to the four or five cable pairs that carry data and clock, it is recommended to provide at least one additional conductor (or pair) which connects ground between the transmitter and receiver. This low impedance ground provides a common mode return path for the two devices. Some of the more commonly used cable types for point-to-point applications include flat ribbon, flex, twisted pair and Twin-Coax. All are available in a variety of configurations and options. Flat ribbon cable, flex and twisted pair generally perform well in short point-to-point applications while Twin-Coax is good for short and long applications. When using ribbon cable, it is recommended to place a ground line between each differential pair to act as a barrier to noise coupling between adjacent pairs. For Twin-Coax cable applications, it is recommended to utilize a shield on each cable pair. All extended point-to-point applications should also employ an overall shield surrounding all cable pairs regardless of the cable type. This overall shield results in improved transmission parameters such as faster attainable speeds, longer distances between transmitter and receiver and reduced problems associated with EMS or EMI.

The high-speed transport of LVDS signals has been demonstrated on several types of cables with excellent results. However, the best overall performance has been seen when using Twin-Coax cable. Twin-Coax has very low cable skew and EMI due to its construction and double shielding. All of the design considerations discussed here and listed in the supplemental application notes provide the subsystem communications designer with many useful guidelines. It is recommended that the designer assess the tradeoffs of each application thoroughly to arrive at a reliable and economical cable solution.

BOARD LAYOUT: To obtain the maximum benefit from the noise and EMI reductions of LVDS, attention should be paid

Applications Information (Continued)

to the layout of differential lines. Lines of a differential pair should always be adjacent to eliminate noise interference from other signals and take full advantage of the noise canceling of the differential signals. The board designer should also try to maintain equal length on signal traces for a given differential pair. As with any high speed design, the impedance discontinuities should be limited (reduce the numbers of vias and no 90 degree angles on traces). Any discontinuities which do occur on one signal line should be mirrored in

the other line of the differential pair. Care should be taken to ensure that the differential trace impedance match the differential impedance of the selected physical media (this impedance should also match the value of the termination resistor that is connected across the differential pair at the receiver's input). Finally, the location of the CHANNEL LINK TxOUT/RxIN pins should be as close as possible to the board edge so as to eliminate excessive pcb runs. All of these considerations will limit reflections and crosstalk which adversely effect high frequency performance and EMI.

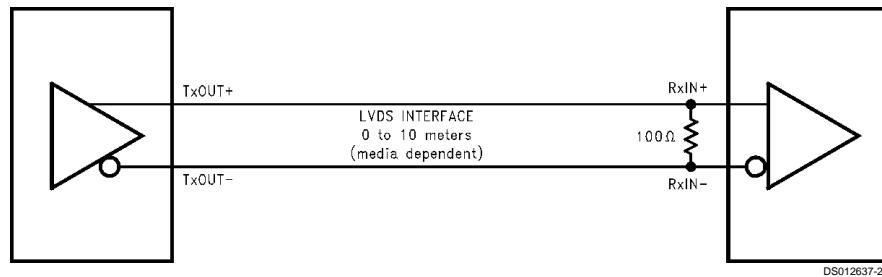

FIGURE 18. LVDS Serialized Link Termination

UNUSED INPUTS: All unused inputs at the TxW inputs of the transmitter must be tied to ground. All unused outputs at the RxOUT outputs of the receiver must then be left floating.

TERMINATION: Use of current mode drivers requires a terminating resistor across the receiver inputs. The CHANNEL LINK chipset will normally require a single 100Ω resistor between the true and complement lines on each differential pair of the receiver input. The actual value of the termination resistor should be selected to match the differential mode characteristic impedance (90Ω to 120Ω typical) of the cable. *Figure 18* shows an example. No additional pull-up or pull-down resistors are necessary as with some other differential technologies such as PECL. Surface mount resistors are recommended to avoid the additional inductance that accompanies leaded resistors. These resistors should be placed as close as possible to the receiver input pins to reduce stubs and effectively terminate the differential lines.

DECOUPLING CAPACITORS: Bypassing capacitors are needed to reduce the impact of switching noise which could limit performance. For a conservative approach three parallel-connected decoupling capacitors (Multi-Layered Ceramic type in surface mount form factor) between each V_{CC} and the ground plane(s) are recommended. The three capacitor values are 0.1 μF, 0.01 μF and 0.001 μF. An example is shown in *Figure 19*. The designer should employ wide traces for power and ground and ensure each capacitor has its own via to the ground plane. If board space is limiting the number of bypass capacitors, the PLL V_{CC} should receive the most filtering/bypassing. Next would be the LVDS V_{CC} pins and finally the logic V_{CC} pins.

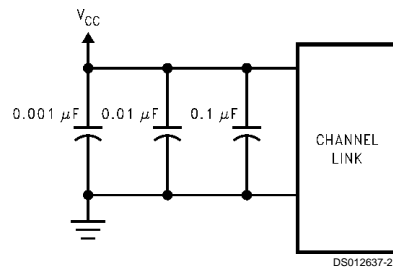

FIGURE 19. CHANNEL LINK Decoupling Configuration

CLOCK JITTER: The CHANNEL LINK devices employ a PLL to generate and recover the clock transmitted across the LVDS interface. The width of each bit in the serialized LVDS data stream is one-seventh the clock period. For example, a 40 MHz clock has a period of 25 ns which results in a data bit width of 3.57 ns. Differential skew (Δt within one differential pair), interconnect skew (Δt of one differential pair to another) and clock jitter will all reduce the available window for sampling the LVDS serial data streams. Care must be taken to ensure that the clock input to the transmitter be a clean low noise signal. Individual bypassing of each V_{CC} to ground will minimize the noise passed on to the PLL, thus creating a low jitter LVDS clock. These measures provide more margin for channel-to-channel skew and interconnect skew as a part of the overall jitter/skew budget.

Applications Information (Continued)

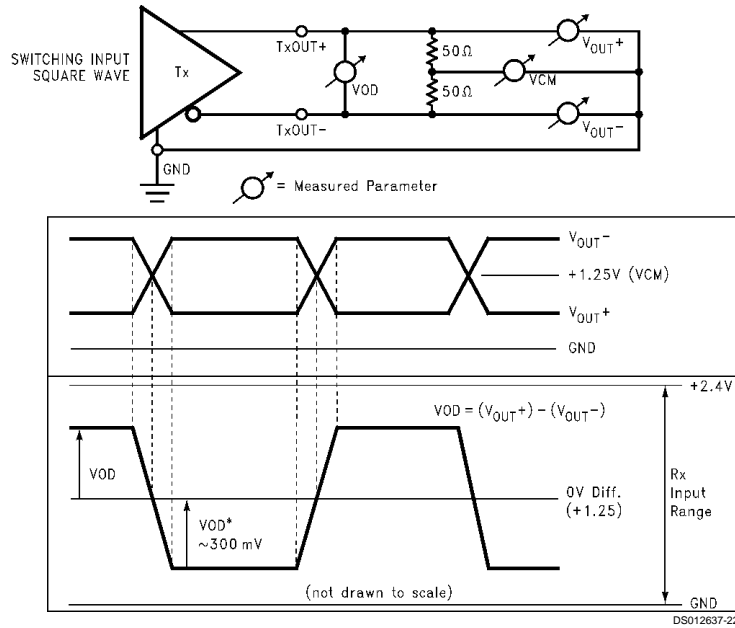

FIGURE 20. Single-Ended and Differential Waveforms

COMMON MODE vs. DIFFERENTIAL MODE NOISE MARGIN: The typical signal swing for LVDS is 300 mV centered at +1.2V. The CHANNEL LINK receiver supports a 100 mV threshold therefore providing approximately 200 mV of differential noise margin. Common mode protection is of more importance to the system's operation due to the differential data transmission. LVDS supports an input voltage range of Ground to +2.4V. This allows for a $\pm 1.0V$ shifting of the center point due to ground potential differences and common mode noise.

POWER SEQUENCING AND POWERDOWN MODE: Outputs of the CHANNEL LINK transmitter remain in TRI-STATE® until the power supply reaches 3V. Clock and data outputs will begin to toggle 10 ms after V_{CC} has reached 4.5V and the Powerdown pin is above 2V. Either device may be placed into a powerdown mode at any time by asserting the Powerdown pin (active low). Total power dissipation for each device will decrease to 5 μW (typical).

The CHANNEL LINK chipset is designed to protect itself from accidental loss of power to either the transmitter or receiver. If power to the transmit board is lost, the receiver clocks (input and output) stop. The data outputs (RxOUT) retain the states they were in when the clocks stopped. When the receiver board loses power, the receiver inputs are shorted to V_{CC} through an internal diode. Current is limited (5 mA per input) by the fixed current mode drivers, thus avoiding the potential for latchup when powering the device.



Physical Dimensions inches (millimeters) unless otherwise noted

48-Lead Molded Thin Shrink Small Outline Package, JEDEC
Order Number DS90CR211MTD or DS90CR212MTD
NS Package Number MTD48

MTD48 (REV A)

LIFE SUPPORT POLICY

NATIONAL'S PRODUCTS ARE NOT AUTHORIZED FOR USE AS CRITICAL COMPONENTS IN LIFE SUPPORT DEVICES OR SYSTEMS WITHOUT THE EXPRESS WRITTEN APPROVAL OF THE PRESIDENT OF NATIONAL SEMICONDUCTOR CORPORATION. As used herein:

- Life support devices or systems are devices or systems which, (a) are intended for surgical implant into the body, or (b) support or sustain life, and whose failure to perform when properly used in accordance with instructions for use provided in the labeling, can be reasonably expected to result in a significant injury to the user.
- A critical component in any component of a life support device or system whose failure to perform can be reasonably expected to cause the failure of the life support device or system, or to affect its safety or effectiveness.

<p>National Semiconductor Corporation Americas Tel: 1-800-272-9959 Fax: 1-800-737-7018 Email: support@nsc.com</p>	<p>National Semiconductor Europe</p> <p>Fax: +49 (0) 1 80-530 85 86 Email: europe.support@nsc.com</p> <p>Deutsch Tel: +49 (0) 1 80-530 85 85 English Tel: +49 (0) 1 80-532 78 32 Français Tel: +49 (0) 1 80-532 93 58 Italiano Tel: +49 (0) 1 80-534 16 80</p>	<p>National Semiconductor Asia Pacific Customer Response Group</p> <p>Tel: 65-2544466 Fax: 65-2504466 Email: sea.support@nsc.com</p>	<p>National Semiconductor Japan Ltd.</p> <p>Tel: 81-3-5620-6175 Fax: 81-3-5620-6179</p>
--	---	---	---

www.national.com

National does not assume any responsibility for use of any circuitry described, no circuit patent licenses are implied and National reserves the right at any time without notice to change said circuitry and specifications.