

RF Power Field Effect Transistors

N-Channel Enhancement-Mode Lateral MOSFETs

Designed for PCN and PCS base station applications with frequencies from 1900 to 2000 MHz. Suitable for TDMA, CDMA and multicarrier amplifier applications.

- Typical CDMA Performance @ 1930 MHz, 26 Volts, $I_{DQ} = 550$ mA
Multi-carrier IS-95 CDMA Pilot, Sync, Paging, Traffic Codes 8 Through 13
Output Power — 9.5 Watts Avg.
Power Gain — 14.9 dB
Efficiency — 23.5%
Adjacent Channel Power —
885 kHz: -50 dBc @ 30 kHz BW
IM3 — -37 dBc
- Capable of Handling 5:1 VSWR, @ 26 Vdc, 1960 MHz, 45 Watts CW Output Power

Features

- Internally Matched for Ease of Use
- High Gain, High Efficiency and High Linearity
- Integrated ESD Protection
- Designed for Maximum Gain and Insertion Phase Flatness
- Excellent Thermal Stability
- Characterized with Series Equivalent Large-Signal Impedance Parameters
- Low Gold Plating Thickness on Leads, 40 μ m Nominal.
- RoHS Compliant
- In Tape and Reel. R3 Suffix = 250 Units per 32 mm, 13 Inch Reel.

MRF19045LR3
MRF19045LSR3

1930-1990 MHz, 45 W, 26 V
LATERAL N-CHANNEL
RF POWER MOSFETs

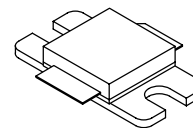

CASE 465E-04, STYLE 1
NI-400
MRF19045LR3

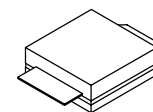

CASE 465F-04, STYLE 1
NI-400S
MRF19045LSR3

ARCHIVE INFORMATION

ARCHIVE INFORMATION

Table 1. Maximum Ratings

Rating	Symbol	Value	Unit
Drain-Source Voltage	V_{DSS}	-0.5, +65	Vdc
Gate-Source Voltage	V_{GS}	-0.5, +15	Vdc
Total Device Dissipation @ $T_C = 25^\circ\text{C}$ Derate above 25 $^\circ\text{C}$	P_D	105 0.60	W W/ $^\circ\text{C}$
Storage Temperature Range	T_{stg}	-65 to +150	$^\circ\text{C}$
Case Operating Temperature	T_C	150	$^\circ\text{C}$
Operating Junction Temperature	T_J	200	$^\circ\text{C}$

Table 2. Thermal Characteristics

Characteristic	Symbol	Value ⁽¹⁾	Unit
Thermal Resistance, Junction to Case	$R_{\theta JC}$	1.65	$^\circ\text{C}/\text{W}$

Table 3. ESD Protection Characteristics

Test Conditions	Class
Human Body Model	2 (Minimum)
Machine Model	M3 (Minimum)

1. Refer to AN1955/D, *Thermal Measurement Methodology of RF Power Amplifiers*. Go to <http://www.freescale.com/rf>.
Select Documentation/Application Notes - AN1955.

Table 4. Electrical Characteristics ($T_C = 25^\circ\text{C}$ unless otherwise noted)

Characteristic	Symbol	Min	Typ	Max	Unit
Off Characteristics					
Drain-Source Breakdown Voltage ($V_{GS} = 0\text{ Vdc}$, $I_D = 100\ \mu\text{Adc}$)	$V_{(BR)DSS}$	65	—	—	Vdc
Zero Gate Voltage Drain Current ($V_{DS} = 26\text{ Vdc}$, $V_{GS} = 0\text{ Vdc}$)	I_{DSS}	—	—	10	μAdc
Gate-Source Leakage Current ($V_{GS} = 5\text{ Vdc}$, $V_{DS} = 0\text{ Vdc}$)	I_{GSS}	—	—	1	μAdc
On Characteristics (DC)					
Gate Threshold Voltage ($V_{DS} = 10\text{ Vdc}$, $I_D = 100\ \mu\text{Adc}$)	$V_{GS(th)}$	2	—	4	Vdc
Gate Quiescent Voltage ($V_{DS} = 26\text{ Vdc}$, $I_D = 550\text{ mAdc}$)	$V_{GS(Q)}$	3	3.8	5	Vdc
Drain-Source On-Voltage ($V_{GS} = 10\text{ Vdc}$, $I_D = 1\text{ Adc}$)	$V_{DS(on)}$	—	0.19	0.21	Vdc
Forward Transconductance ($V_{DS} = 10\text{ Vdc}$, $I_D = 2\text{ Adc}$)	g_{fs}	—	4.2	—	S
Dynamic Characteristics					
Reverse Transfer Capacitance (1) ($V_{DS} = 26\text{ Vdc}$, $V_{GS} = 0$, $f = 1.0\text{ MHz}$)	C_{rss}	—	1.8	—	pF
Functional Tests (In Freescale Test Fixture, 50 ohm system) 2-carrier N-CDMA, 1.2288 MHz Channel Bandwidth, IM3 measured in 1.2288 MHz Integrated Bandwidth. ACPR measured in 30 kHz Integrated Bandwidth.					
Common-Source Amplifier Power Gain ($V_{DD} = 26\text{ Vdc}$, $P_{out} = 9.5\text{ W Avg}$, 2-Carrier N-CDMA, $I_{DQ} = 550\text{ mA}$, $f_1 = 1930\text{ MHz}$, $f_2 = 1932.5\text{ MHz}$)	G_{ps}	13	14.5	—	dB
Drain Efficiency ($V_{DD} = 26\text{ Vdc}$, $P_{out} = 9.5\text{ W Avg}$, 2-Carrier N-CDMA, $I_{DQ} = 550\text{ mA}$, $f_1 = 1930\text{ MHz}$, $f_2 = 1932.5\text{ MHz}$)	η	21	23.5	—	%
3rd Order Intermodulation Distortion ($V_{DD} = 26\text{ Vdc}$, $P_{out} = 9.5\text{ W Avg}$, 2-Carrier N-CDMA, $I_{DQ} = 550\text{ mA}$, $f_1 = 1930\text{ MHz}$, $f_2 = 1932.5\text{ MHz}$; IM3 Measured in a 1.2288 MHz Integrated Bandwidth Centered at $f_1 - 2.5\text{ MHz}$ and $f_2 + 2.5\text{ MHz}$, Referenced to the Carrier Channel Power)	IM3	—	-37	-35	dBc
Adjacent Channel Power Ratio ($V_{DD} = 26\text{ Vdc}$, $P_{out} = 9.5\text{ W Avg}$, 2-carrier N-CDMA, $I_{DQ} = 550\text{ mA}$, $f_1 = 1930\text{ MHz}$, $f_2 = 1932.5\text{ MHz}$; ACPR measured in a 30 kHz Integrated Bandwidth Centered at $f_1 - 885\text{ kHz}$ and $f_2 + 885\text{ kHz}$)	ACPR	—	-51	-45	dBc
Input Return Loss ($V_{DD} = 26\text{ Vdc}$, $P_{out} = 9.5\text{ W Avg}$, 2-Carrier N-CDMA, $I_{DQ} = 550\text{ mA}$, $f_1 = 1930\text{ MHz}$, $f_2 = 1932.5\text{ MHz}$)	IRL	—	-16	-9	dB
P_{out} , 1 dB Compression Point ($V_{DD} = 26\text{ Vdc}$, $I_{DQ} = 550\text{ mA}$, $f = 1930\text{ MHz}$)	P1dB	—	45	—	W

1. Part is internally matched both on input and output.

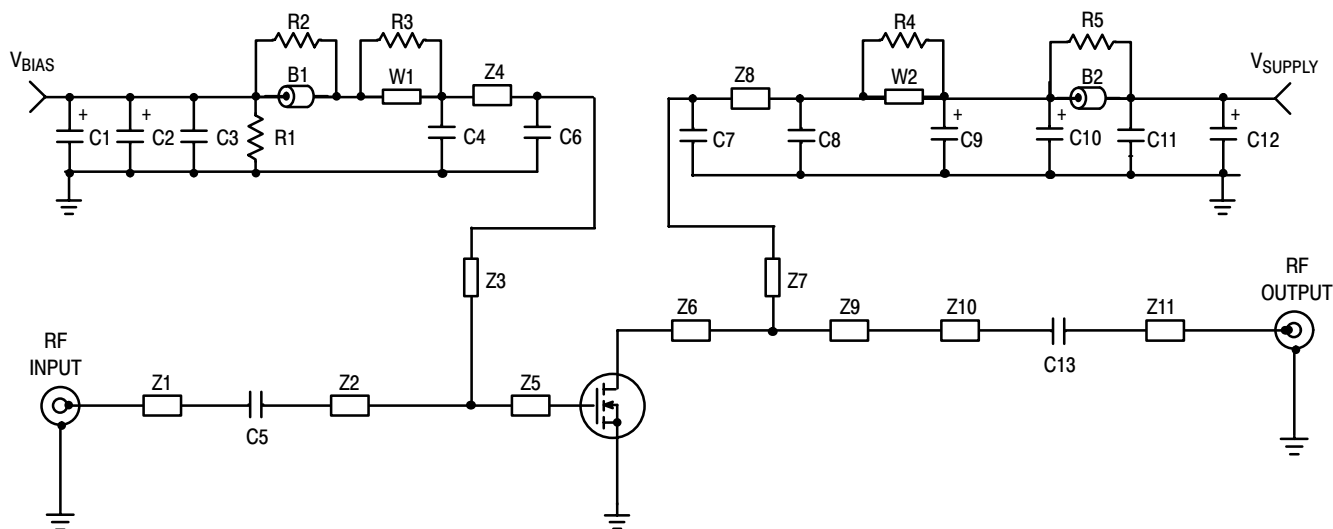

Z1	1.336" x 0.081" Microstrip	Z8	0.216" x 0.047" Microstrip
Z2	0.693" x 0.081" Microstrip	Z9	0.519" x 0.254" Microstrip
Z3	1.033" x 0.047" Microstrip	Z10	0.874" x 0.081" Microstrip
Z4	0.468" x 0.047" Microstrip	Z11	0.645" x 0.081" Microstrip
Z5	0.271" x 0.460" Microstrip	PCB	Arlon GX0300-55-22, 30 mils, $\epsilon_r = 2.55$
Z6	0.263" x 0.930" Microstrip		
Z7	1.165" x 0.047" Microstrip		

NOTE: Z3, Z4, Z7, Z8 lengths and component placement tolerances are $\pm 0.050"$.
Zx lengths are microstrip lengths between components, center-line to center-line.
All component and z-length tolerances are $\pm 0.015"$, except as noted.

Figure 1. 1930 - 1990 MHz 2-Carrier N-CDMA Test Circuit Schematic

Table 5. 1930 - 1990 MHz 2-Carrier N-CDMA Test Circuit Component Designations and Values

Designators	Description
B1, B2	0.120" x 0.333" x 0.100", Surface Mount Ferrite Beads, Fair Rite #2743019446
C1, C2	10 μ F, 35 V Tantalum Surface Mount Chip Capacitors, Kemet #T495X106K035AS4394
C3, C11	0.1 μ F Chip Capacitors, Kemet #CDR33BX104AKWS
C4, C8	24 pF Chip Capacitors, ATC #100B240JP500X
C5	470 pF Chip Capacitor, ATC #100B471JP200X
C6, C7	11 pF Chip Capacitors, ATC #100B110JP500X
C9, C10, C12	22 μ F, 35 V Tantalum Surface Mount Chip Capacitors, Kemet #T491X226K035AS4394
C13	8.2 pF Chip Capacitor, ATC #100B8R2CP500X
R1	560 k Ω , 1/4 W Chip Resistor (0.08" x 0.13")
R2, R3, R4, R5	8.2 Ω , 1/4 W Chip Resistors (0.08" x 0.13"), Garrett Instruments #RM73B2B110JT
W1, W2	Solid Copper Buss Wire, 16 AWG
WS1, WS2	Beryllium Copper Wear Blocks (0.005" x 0.150" x 0.350") Nominal

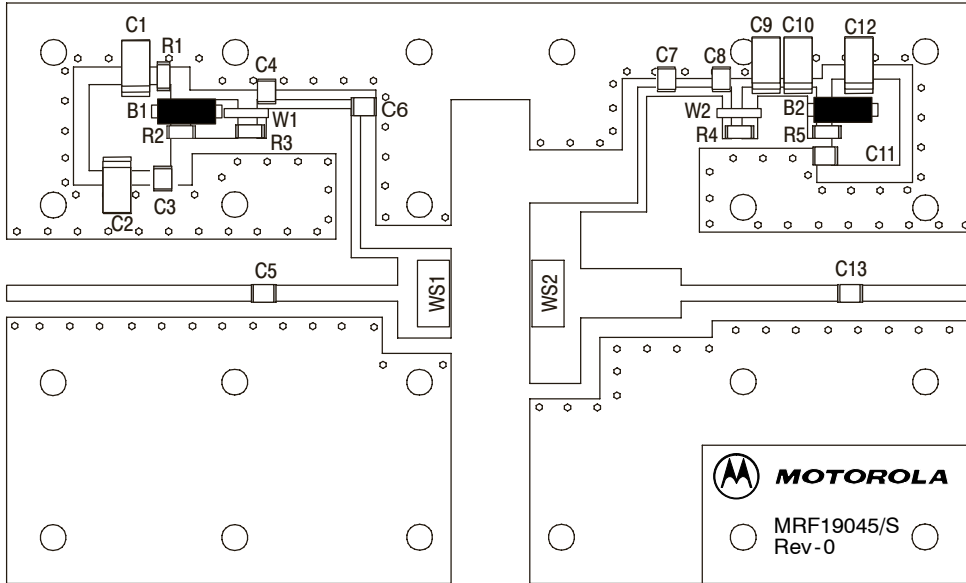

Freescale has begun the transition of marking Printed Circuit Boards (PCBs) with the Freescale Semiconductor signature/logo. PCBs may have either Motorola or Freescale markings during the transition period. These changes will have no impact on form, fit or function of the current product.

Figure 2. 1930 - 1990 MHz 2-Carrier N-CDMA Test Circuit Component Layout

ARCHIVE INFORMATION

ARCHIVE INFORMATION

TYPICAL CHARACTERISTICS

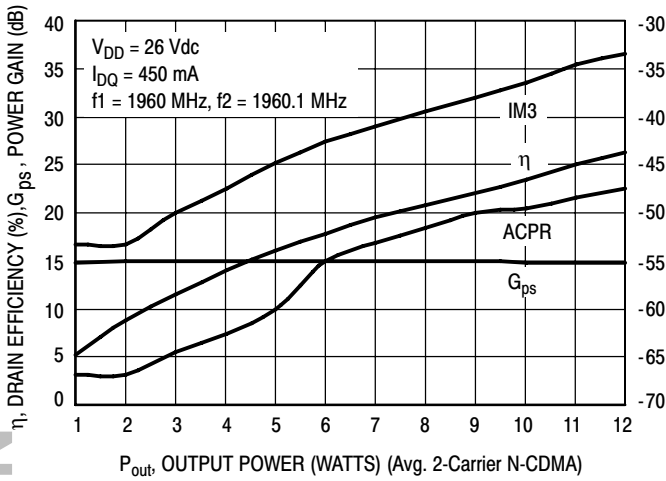

Figure 3. 2-Carrier N-CDMA ACPR, IM3, Power Gain and Drain Efficiency versus Output Power

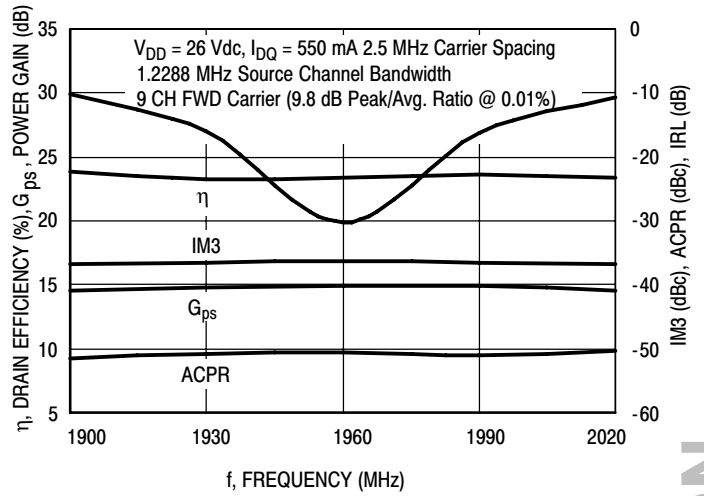

Figure 4. 2-Carrier N-CDMA ACPR, IM3, Power Gain, IRL and Drain Efficiency versus Output Power

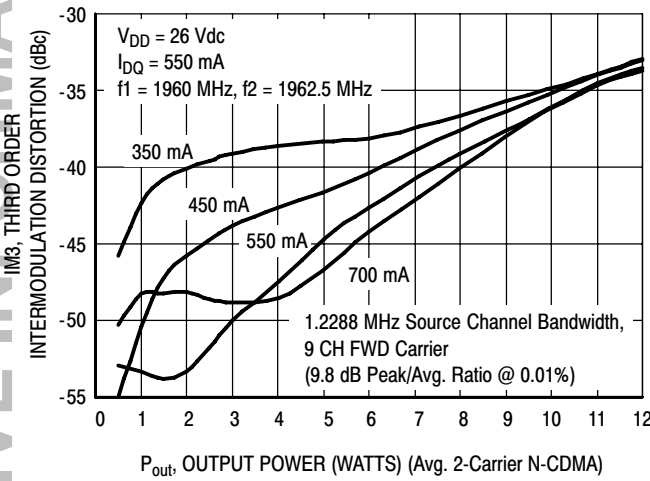

Figure 5. 2-Carrier N-CDMA IM3 versus Output Power

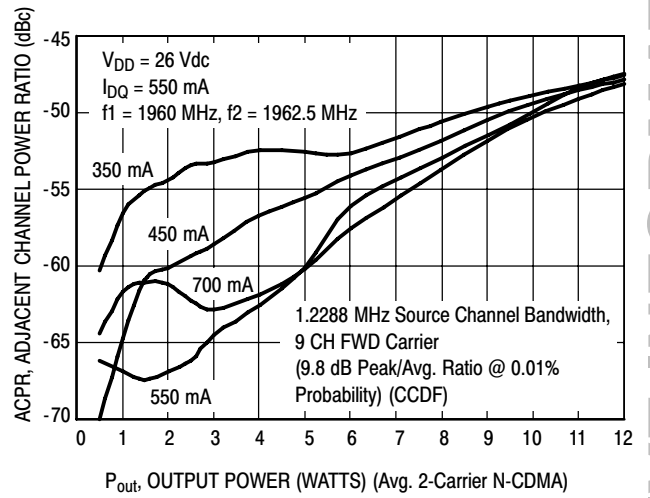

Figure 6. 2-Carrier N-CDMA ACPR versus Output Power

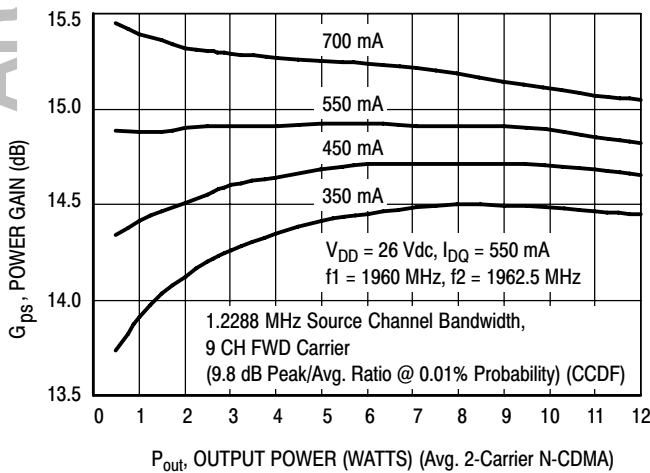

Figure 7. 2-Carrier N-CDMA Power Gain versus Output Power

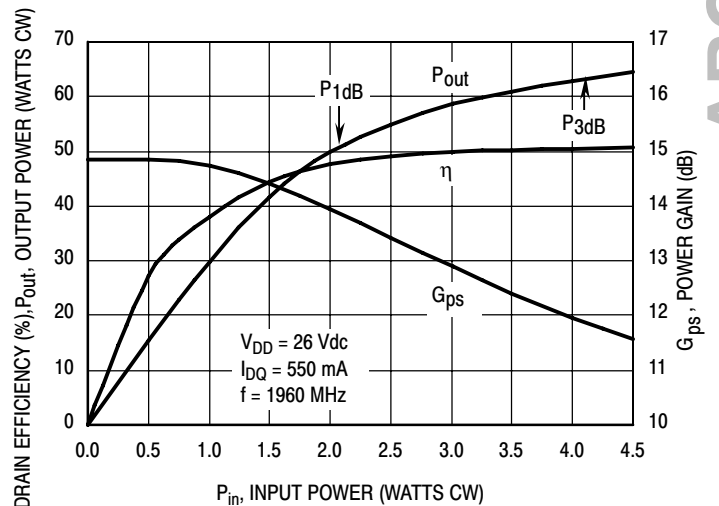

Figure 8. CW Output Power, Power Gain and Drain Efficiency versus Input Power

TYPICAL CHARACTERISTICS

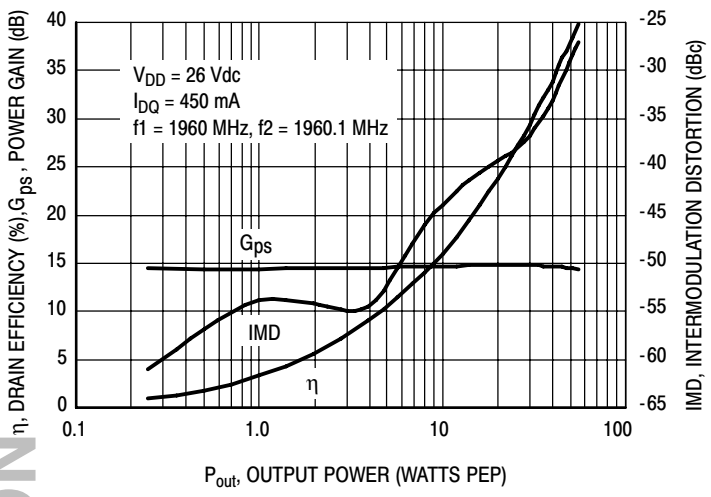

Figure 9. CW Two-Tone Power Gain, IMD and Drain Efficiency versus Output Power

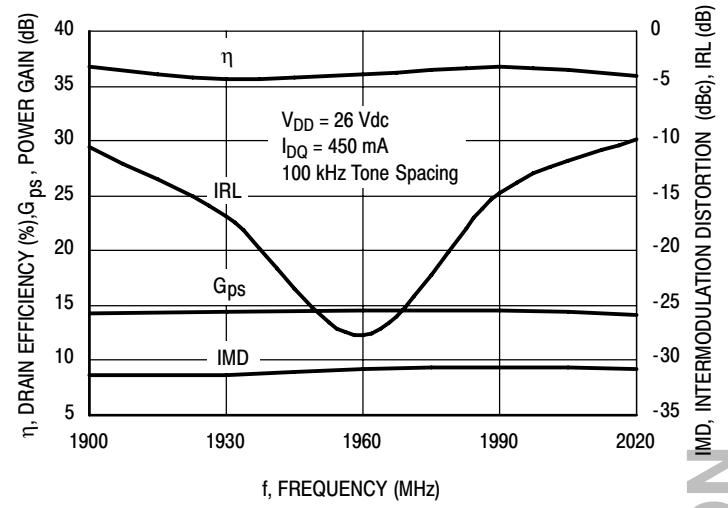

Figure 10. CW Two-Tone Power Gain, Input Return Loss, IMD and Drain Efficiency versus Frequency

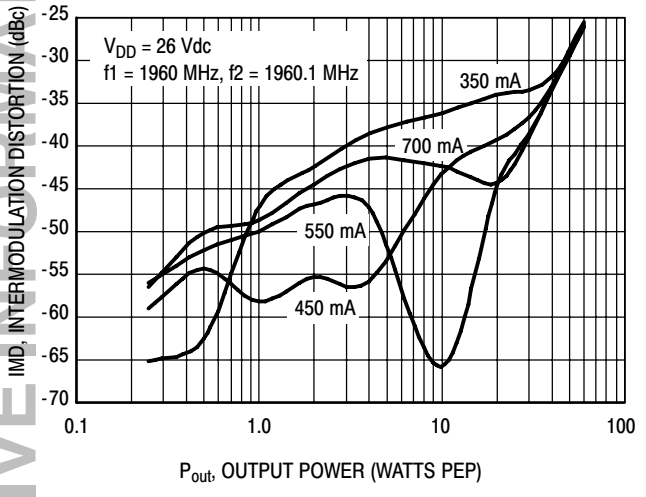

Figure 11. CW Two-Tone Intermodulation Distortion versus Output Power

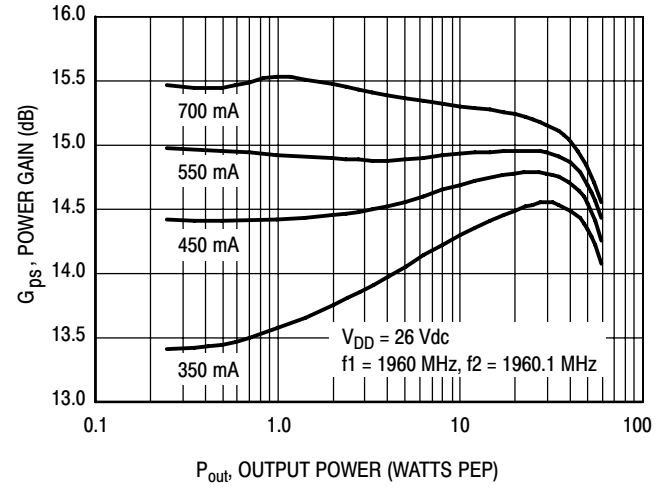

Figure 12. CW Two-Tone Power Gain versus Output Power

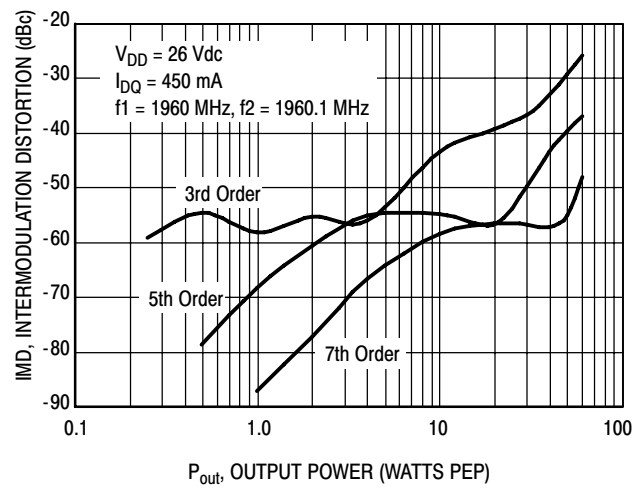

Figure 13. CW Two-Tone Intermodulation Distortion Products versus Output Power

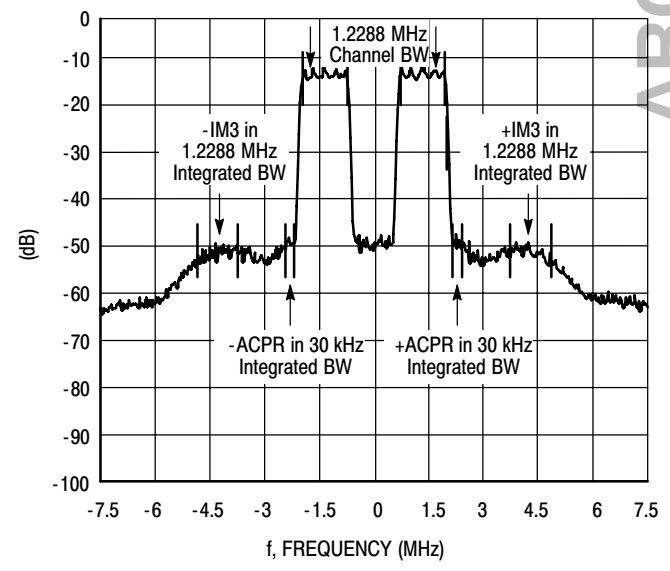
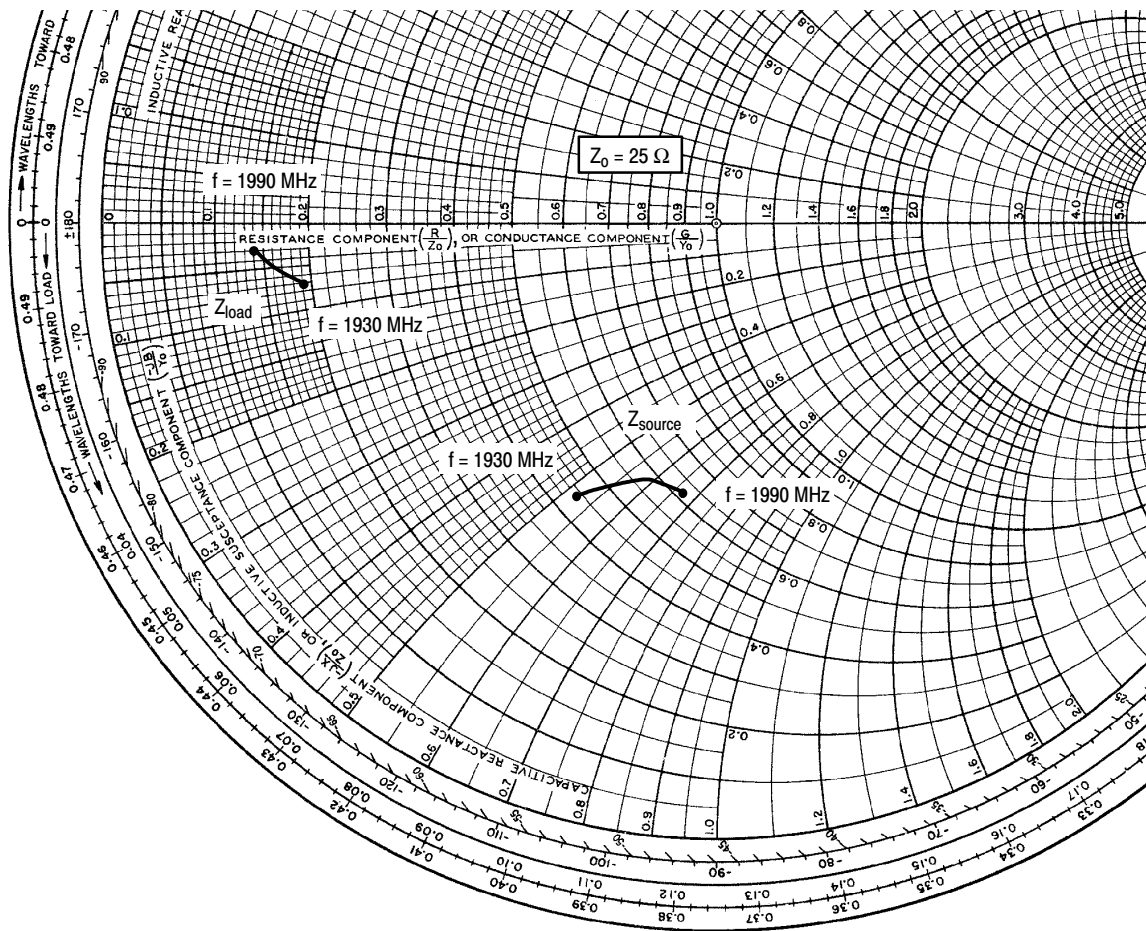

Figure 14. 2-Carrier N-CDMA Spectrum

MRF19045LR3 MRF19045LSR3



$V_{DD} = 26\text{ V}$, $I_{DQ} = 550\text{ mA}$, $P_{out} = 9.5\text{ W Avg.}$

f MHz	Z_{source} Ω	Z_{load} Ω
1930	$15.52 - j16.5$	$4.52 - j1.86$
1960	$14.24 - j14.44$	$3.85 - j1.04$
1990	$11.11 - j13.01$	$3.44 - j0.69$

Z_{source} = Test circuit impedance as measured from gate to ground.

Z_{load} = Test circuit impedance as measured from drain to ground.

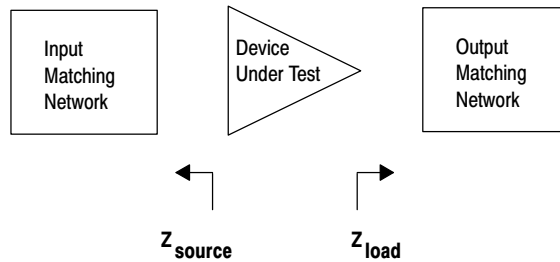
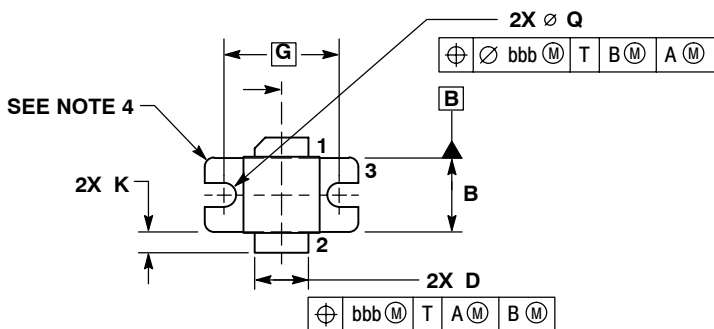

Figure 15. Series Equivalent Source and Load Impedance

PACKAGE DIMENSIONS



- NOTES:
1. CONTROLLING DIMENSION: INCH.
 2. INTERPRET DIMENSIONS AND TOLERANCES PER ASME Y14.5M, 1994.
 3. DIMENSION H IS MEASURED 0.030 (0.762) AWAY FROM PACKAGE BODY.
 4. INFORMATION ONLY: CORNER BREAK (4X) TO BE .060±.005 (1.52±0.13) RADIUS OR .06±.005 (1.52±0.13) x 45° CHAMFER.

DIM	INCHES		MILLIMETERS	
	MIN	MAX	MIN	MAX
A	.795	.805	20.19	20.44
B	.380	.390	9.65	9.9
C	.125	.163	3.17	4.14
D	.275	.285	6.98	7.24
E	.035	.045	0.89	1.14
F	.004	.006	0.10	0.15
G	.600 BSC		15.24 BSC	
H	.057	.067	1.45	1.7
K	.092	.122	2.33	3.1
M	.395	.405	10	10.3
N	.395	.405	10	10.3
Q	Ø .120	Ø .130	Ø 3.05	Ø 3.3
R	.395	.405	10	10.3
S	.395	.405	10	10.3
aaa	.005 BSC		0.127 BSC	
bbb	.010 BSC		0.254 BSC	
ccc	.015 BSC		0.381 BSC	

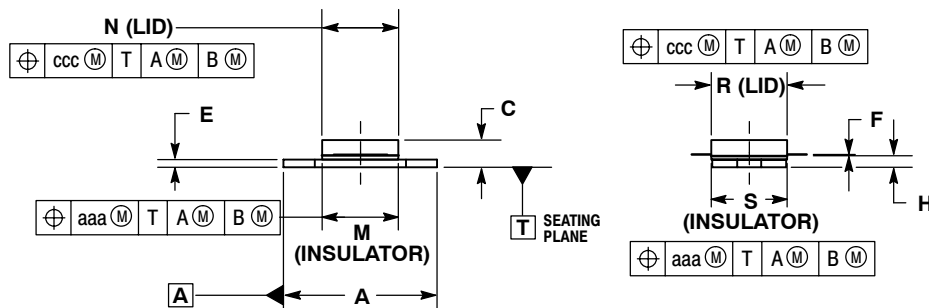

- STYLE 1:
 PIN 1. DRAIN
 2. GATE
 3. SOURCE

**CASE 465E-04
 ISSUE F
 NI-400
 MRF19045LR3**

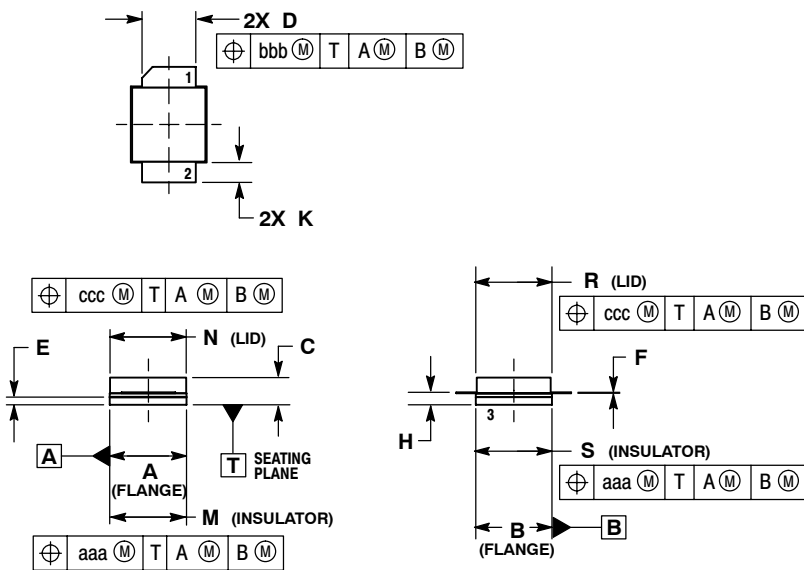

- NOTES:
1. CONTROLLING DIMENSION: INCH.
 2. INTERPRET DIMENSIONS AND TOLERANCES PER ASME Y14.5M-1994.
 3. DIMENSION H IS MEASURED 0.030 (0.762) AWAY FROM PACKAGE BODY.

DIM	INCHES		MILLIMETERS	
	MIN	MAX	MIN	MAX
A	.395	.405	10.03	10.29
B	.395	.405	10.03	10.29
C	.125	.163	3.18	4.14
D	.275	.285	6.98	7.24
E	.035	.045	0.89	1.14
F	.004	.006	0.10	0.15
H	.057	.067	1.45	1.70
K	.092	.122	2.34	3.10
M	.395	.405	10.03	10.29
N	.395	.405	10.03	10.29
R	.395	.405	10.03	10.29
S	.395	.405	10.03	10.29
aaa	.005 REF		0.127 REF	
bbb	.010 REF		0.254 REF	
ccc	.015 REF		0.38 REF	

- STYLE 1:
 PIN 1. DRAIN
 2. GATE
 3. SOURCE

**CASE 465F-04
 ISSUE E
 NI-400S
 MRF19045LSR3**

PRODUCT DOCUMENTATION

Refer to the following documents to aid your design process.

Application Notes

- AN1955: Thermal Measurement Methodology of RF Power Amplifiers

Engineering Bulletins

- EB212: Using Data Sheet Impedances for RF LDMOS Devices

REVISION HISTORY

The following table summarizes revisions to this document.

Revision	Date	Description
9	Oct. 2008	<ul style="list-style-type: none"> • Modified data sheet to reflect RF Test Reduction described in Product and Process Change Notification number, PCN12779, p. 1, 2 • Data sheet archived. Part no longer manufactured. • Added Product Documentation and Revision History, p. 9

ARCHIVE INFORMATION

ARCHIVE INFORMATION

How to Reach Us:**Home Page:**

www.freescale.com

Web Support:

<http://www.freescale.com/support>

USA/Europe or Locations Not Listed:

Freescale Semiconductor, Inc.
Technical Information Center, EL516
2100 East Elliot Road
Tempe, Arizona 85284
1-800-521-6274 or +1-480-768-2130
www.freescale.com/support

Europe, Middle East, and Africa:

Freescale Halbleiter Deutschland GmbH
Technical Information Center
Schatzbogen 7
81829 Muenchen, Germany
+44 1296 380 456 (English)
+46 8 52200080 (English)
+49 89 92103 559 (German)
+33 1 69 35 48 48 (French)
www.freescale.com/support

Japan:

Freescale Semiconductor Japan Ltd.
Headquarters
ARCO Tower 15F
1-8-1, Shimo-Meguro, Meguro-ku,
Tokyo 153-0064
Japan
0120 191014 or +81 3 5437 9125
support.japan@freescale.com

Asia/Pacific:

Freescale Semiconductor China Ltd.
Exchange Building 23F
No. 118 Jianguo Road
Chaoyang District
Beijing 100022
China
+86 10 5879 8000
support.asia@freescale.com

For Literature Requests Only:

Freescale Semiconductor Literature Distribution Center
P.O. Box 5405
Denver, Colorado 80217
1-800-441-2447 or +1-303-675-2140
Fax: +1-303-675-2150
LDCForFreescaleSemiconductor@hibbertgroup.com

Information in this document is provided solely to enable system and software implementers to use Freescale Semiconductor products. There are no express or implied copyright licenses granted hereunder to design or fabricate any integrated circuits or integrated circuits based on the information in this document.

Freescale Semiconductor reserves the right to make changes without further notice to any products herein. Freescale Semiconductor makes no warranty, representation or guarantee regarding the suitability of its products for any particular purpose, nor does Freescale Semiconductor assume any liability arising out of the application or use of any product or circuit, and specifically disclaims any and all liability, including without limitation consequential or incidental damages. "Typical" parameters that may be provided in Freescale Semiconductor data sheets and/or specifications can and do vary in different applications and actual performance may vary over time. All operating parameters, including "Typicals", must be validated for each customer application by customer's technical experts. Freescale Semiconductor does not convey any license under its patent rights nor the rights of others. Freescale Semiconductor products are not designed, intended, or authorized for use as components in systems intended for surgical implant into the body, or other applications intended to support or sustain life, or for any other application in which the failure of the Freescale Semiconductor product could create a situation where personal injury or death may occur. Should Buyer purchase or use Freescale Semiconductor products for any such unintended or unauthorized application, Buyer shall indemnify and hold Freescale Semiconductor and its officers, employees, subsidiaries, affiliates, and distributors harmless against all claims, costs, damages, and expenses, and reasonable attorney fees arising out of, directly or indirectly, any claim of personal injury or death associated with such unintended or unauthorized use, even if such claim alleges that Freescale Semiconductor was negligent regarding the design or manufacture of the part.

Freescale™ and the Freescale logo are trademarks of Freescale Semiconductor, Inc. All other product or service names are the property of their respective owners.

© Freescale Semiconductor, Inc. 2008. All rights reserved.