

High Performance DC Amplifier with Pushbutton Sensitivity Adjustment

- Maintenance is made easier with pushbutton sensitivity adjustment
- Sensing distance is up to 100% longer than standard amplifiers
- Choose either single channel or four channel models
- Compact housing: 32 mm and 10 mm housing widths
- Four amplifiers in a single housing saves space and wiring
- Four fiber-optic cables can be mounted directly next to each other without mutual interference

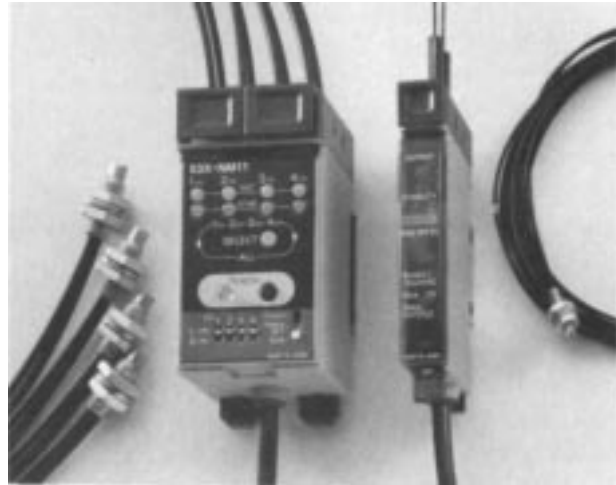

Ordering Information

■ AMPLIFIERS

Type		Single channel		Four channel
Off-delay timer		None	Provided	Provided
Remote teach input		None	Provided	Provided
Part number	NPN output	E3X-NT11	E3X-NT21	E3X-NM11
	PNP output	E3X-NT41	E3X-NT51	E3X-NM41

■ FIBER-OPTIC CABLES

Please see the E32 Fiber-Optic Cables section.

■ ACCESSORIES

Description	Part number
Replacement protective cover for E3X-NT□□	E39-G8
Replacement protective cover for E3X-NM□□	E39-G9

Specifications

Description		General-purpose	Multi-function	Four-channel
Part number	NPN	E3X-NT11	E3X-NT21	E3X-NM11
	PNP	E3X-NT41	E3X-NT51	E3X-NM41
Supply voltage		12 to 24 VDC \pm 10%, 10% ripple max.		
Current consumption		50 mA max.		150 mA max.
Required fiber-optic cables		Please see the E32 Fiber-Optic Cables section.		
Light source		Pulse modulated red LED (680 nm)		
Operation mode		Light-ON, Dark-ON (switch selectable)		
Sensitivity		Pushbutton setting (see operation section)		
Mutual interference protection		Provided		
Remote teach option		—	Provided	
Control output	DC solid state	Type	NPN open collector PNP open collector	
		Max. load	100 mA, 30 VDC max.	
		Max. ON-state voltage drop	1 VDC max. at 100 mA	
Response time		500 μ s max. at rated detection distance		
Timing functions		—	OFF: delay, 40 ms, selectable ON or OFF	
Circuit protection		Output short circuit protection, DC power reverse polarity protection		
Teaching confirmation function		Indicators (red/green LED) and buzzer		
Indicators		Operation (orange LED) and output stability (green LED)		
Materials	Case	PBT plastic		
	Cover	Polycarbonate		
Mounting		DIN-rail track, or on flat surface through holes in bracket (provided)		
Connections	Pre-leaded	3 conductor cable, 2 m (6.5 ft)	4 conductor cable, 2 m (6.5 ft)	7 conductor cable, 2 m (6.5 ft)
		100 g (3.5 oz.) with 2 m cable		
Weight		100 g (3.5 oz.) with 2 m cable		
Enclosure ratings	UL	—		
	NEMA	—		
	IEC	IP 50 (with cover on)		
Approvals	UL	—		
	CSA	—		
Ambient temperature		Operating: -25°C to 55°C (-13°F to 131°F) with no ice buildup		
		Storage: -40°C to 70°C (-40°F to 158°F)		

OUTPUT CIRCUIT DIAGRAMS

E3X-NT11

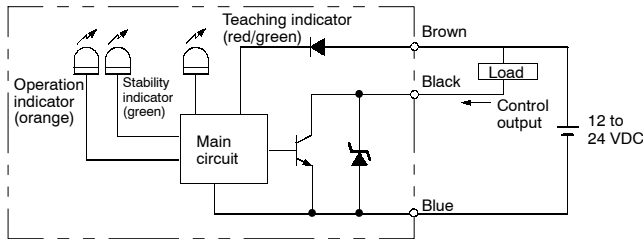

E3X-NT21

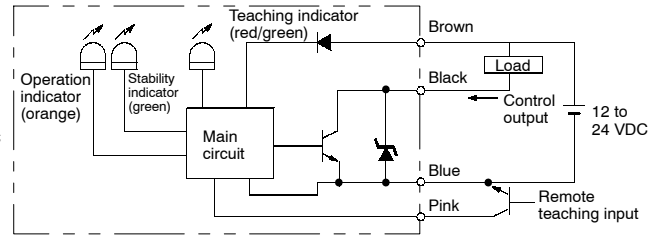

E3X-NM11

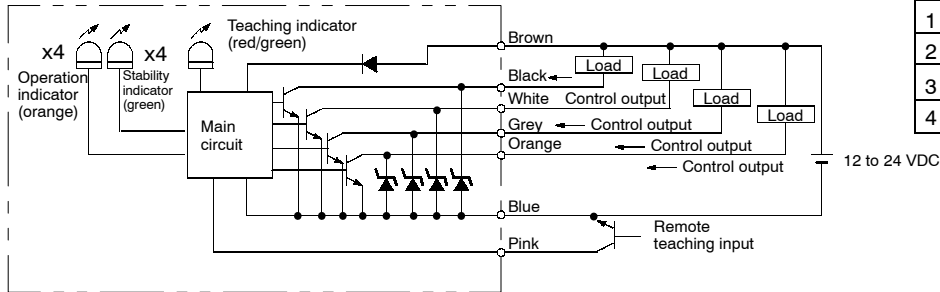

Channel no.	Control output wire color
1	Black
2	White
3	Grey
4	Orange

E3X-NT41

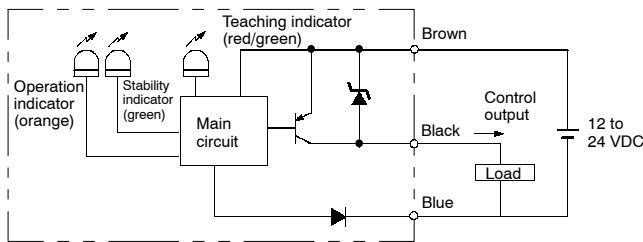

E3X-NT51

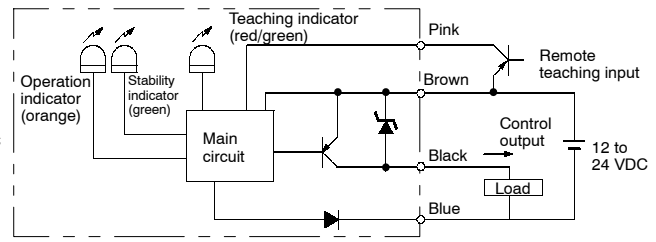

E3X-NM41

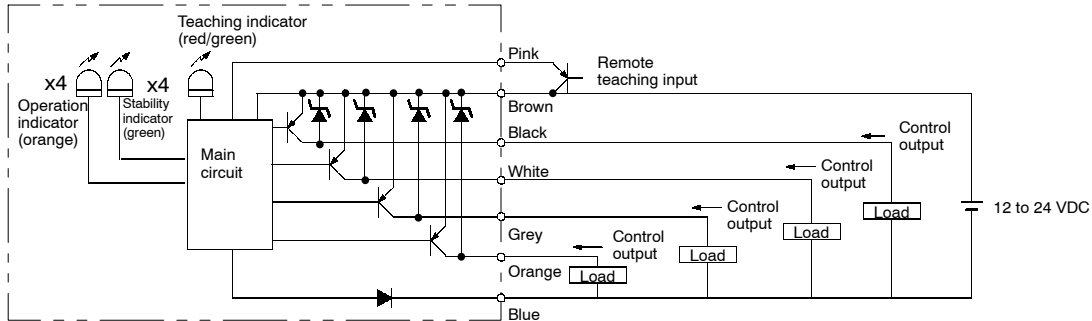

Channel no.	Control output wire color
1	Black
2	White
3	Grey
4	Orange

Nomenclature

E3X-NT11 (NPN)
E3X-NT21 (NPN)
E3X-NT41 (PNP)
E3X-NT51 (PNP)

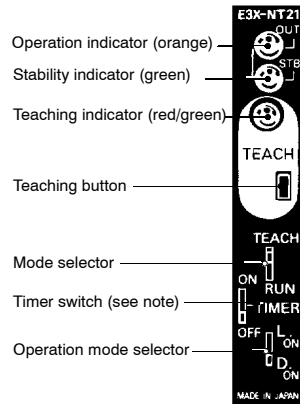

Operation indicator (orange)

Stability indicator (green)

Teaching indicator (red/green)

Teaching button

Mode selector

Timer switch (see note)

Operation mode selector

E3X-NM11 (NPN)
E3X-NM41 (PNP)

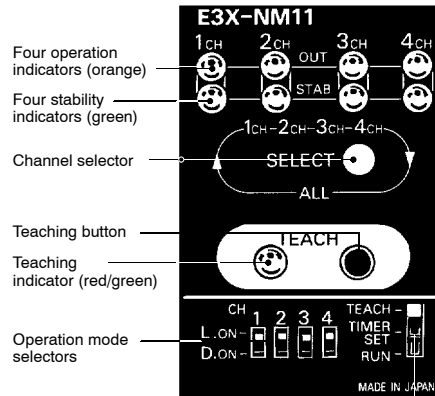

Four operation indicators (orange)

Four stability indicators (green)

Channel selector

Teaching button

Teaching indicator (red/green)

Operation mode selectors

Mode selector

Note: The E3X-NT11 or E3X-NT41 do not have a timer function.

Operation

■ CHOOSING THE RIGHT TEACHING METHOD





Refer to the following table to select the most suitable sensitivity setting method.

Teaching method	Maximum sensitivity setting	No-object teaching	With/Without-object teaching
Typical application	Detection of the existence of objects that interrupt light perfectly Detection of objects with no background objects	If teaching is impossible by stopping the movement of sensing objects	Detection of a slight difference in reflection Color discrimination
		To detect bright or dark objects by teaching only with background objects	Background objects with unstable reflection Detection of object surface irregularities
		Elimination of background object influence	

- Note: 1. None of the four channels has any output when the E3X-NM (four channels) is in teaching mode (i.e., all the four channels will be in teaching mode).
2. If the set distance is very short (i.e., 0 to 12 mm for the E32-TC200 and 0 to 4 mm for the E32-DC200), no-object teaching is not possible due to excessive light, in which case, perform with/without-object teaching.
3. In principle, use the E3X-NM (four channels) for the close connection of a maximum of four Fiber Units. When closely connecting two to three Fiber Units to more than one E3X-NT (one channel), perform with/without-object teaching, in which case teaching must be performed on a single E3X-NT at a time. Therefore, turn on only the E3X-NT on which teaching is performed. If all the E3X-NTs are turned on, interrupt the emitters of the Fiber Units on which teaching is not performed.

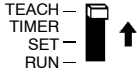
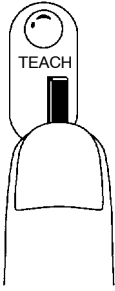
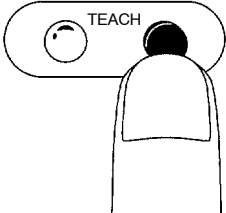
■ MAXIMUM SENSITIVITY SETTING

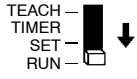
Note: The sensitivity of the E3X-NT and E3X-NM are set to maximum before shipping. When resetting the sensitivity of the E3X-NT or E3X-NM to maximum after no-object teaching or with/without-object teaching, follow the steps described below.

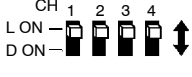
Procedure	Operation	E3X-NT	E3X-NM
1	Locate the sensor head within the rated sensing range with the E3X-N□.		
2	Set the mode selector to TEACH.		
3	The flashing function of the E3X-N□ will be activated. Therefore, adjust the optical axes so that the tip of the emitting fiber will be lit. If the optical axes are divergent, the tip of the emitting fiber will flash and the built-in buzzer of the E3X-N□ will beep.	---	
4	Press the teaching button for three seconds minimum with or without a sensing object. In the case of the E3X-NM, select a channel with the channel selector, at which time the stability indicator for the selected channel will flash. The teaching indicator (red) turns green. The built-in buzzer beeps once when the color of the teaching indicator is red. The built-in buzzer beeps continuously when the color of the teaching indicator is green. Note: The built-in buzzer will stop beeping when the teaching button is no longer being pressed.		
5	Set the mode selector to RUN to complete the sensitivity setting. The teaching indicator is OFF. Note: When the sensitivity is set to maximum, the sensitivity will be automatically adjusted regardless of the set distances of the fibers or light.		
6	Select the logical output required with the operation mode selector.		

■ NO-OBJECT TEACHING

Procedure	Operation	E3X-NT	E3X-NM
1	Locate the sensor head within the rated sensing range with the E3X-N□.		
2	Set the mode selector to TEACH.		
3	The flashing function of the E3X-N□ will be activated. Therefore, adjust the optical axes so that the tip of the emitting fiber will be lit. If the optical axes are divergent, the tip of the emitting fiber will flash and the built-in buzzer of the E3X-N□ will beep.	---	
4	Press the teaching button for 0.5 to 2.5 seconds without a sensing object. In the case the E3X-NM, select a channel with the channel selector and press the teaching button, at which time the stability indicator for the selected channel will flash. The teaching indicator (red) is lit. The built-in buzzer beeps once.		
5	Set the mode selector to RUN. No-object teaching will be set when the first sensing object passes through the sensing area. The teaching indicator (red) turns green (automatically turned off in one second).		
6	Select the logical output required with the operation mode selector.		

- Note: 1. To detect dark objects in front of bright backgrounds, set the operation mode selector to D. ON.
2. If the set distance is very short (i.e., 0 to 12 mm for the E32-TC200 and 0 to 4 mm for the E32-DC200), no-object teaching is not possible due to excessive light, in which case, perform with/without-object teaching.
3. If the teaching button is pressed for more than three seconds, the sensitivity of the E3X-N□ will be set to maximum, at which time the green indicator will be lit.
4. The E3X-N□ will be ready to detect objects in approximately one second after the mode selector is set to RUN.

■ SENSITIVITY ADJUSTMENT

Combination of the E3X-NT/E3X-NM and Fine Through-beam Fiber Units (E32-T22S/T24S/T84S)

No-object Teaching

Press the teaching button once with no object in the sensing area.

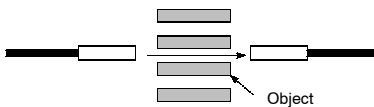

Note: If detection is not stable after no-object teaching, perform with/without-object teaching.

With/Without-object Teaching

Press the teaching button once with no object in the sensing area.



NOTE: DIMENSIONS SHOWN ARE IN MILLIMETERS. To convert millimeters to inches divide by 25.4.

OMRON[®]**OMRON ELECTRONICS LLC**One East Commerce Drive
Schaumburg, IL 60173**1-800-55-OMRON****OMRON ON-LINE**Global - <http://www.omron.com>
USA - <http://www.omron.com/oei>
Canada - <http://www.omron.com/oci>**OMRON CANADA, INC.**885 Milner Avenue
Scarborough, Ontario M1B 5V8**416-286-6465**