

ACPDT-36VEU-HF

RoHS Device
Halogen Free

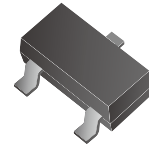

Features

- Unidirectional ESD protection diode.
- High ESD protection level.
- Working voltage: 36V.
- Low clamping voltage.
- Low leakage current.
- AEC-Q101 Qualified.

Mechanical data

- Case: SOT-23 Standard package, molded plastic.
- Terminals: Solderable per MIL-STD-750, method 2026.
- Mounting position: Any.

Circuit Diagram

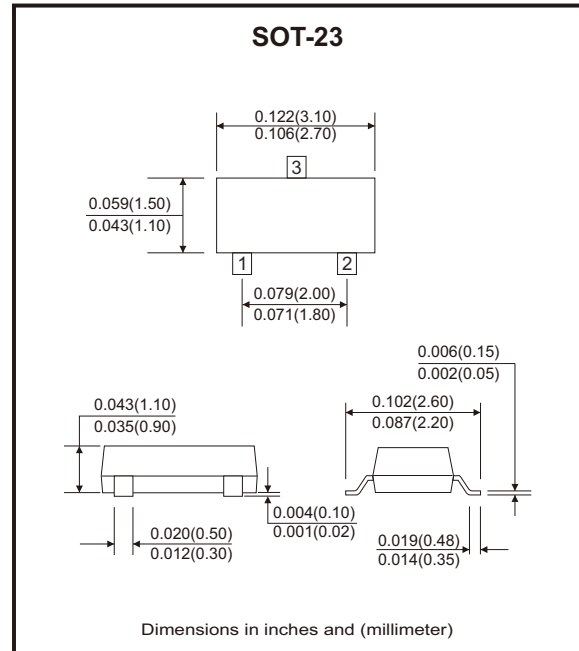
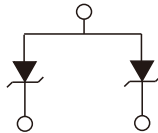

Maximum Rating (at $T_A=25^{\circ}\text{C}$ unless otherwise noted)

Parameter	Conditions	Symbol	Value	Unit
Peak pulse power	$T_P = 8/20\mu\text{s}$	P_{PP}	100	W
Peak pulse current	$T_P = 8/20\mu\text{s}$	I_{PP}	1.5	A
Operating temperature		T_j	-40~+125	$^{\circ}\text{C}$
Storage temperature range		T_{STG}	-55~+150	$^{\circ}\text{C}$

Electrical Characteristics (at $T_A=25^{\circ}\text{C}$ unless otherwise noted)

Parameter	Conditions	Symbol	Min	Typ	Max	Unit
Reverse stand-off voltage		V_{RWM}			36	V
Breakdown voltage	$I_R = 1\text{mA}$	V_{BR}	40			V
Reverse leakage current	$V_R = 36\text{V}$	I_R			0.1	μA
Forward voltage	$I_F = 10\text{mA}$	V_F			1.2	V
Clamping voltage	$I_{PP} = 1\text{A}$, $T_P = 8/20\mu\text{s}$	V_C			58	V
Junction capacitance	$V_R = 0\text{V}$, $f = 1\text{MHz}$	C_J		20		pF

Typical Rating and Characteristic Curves (ACPDT-36VEU-HF)

Fig.1 - 8/20 μ s Peak Pulse Current Waveform ACC. IEC 61000-4-5

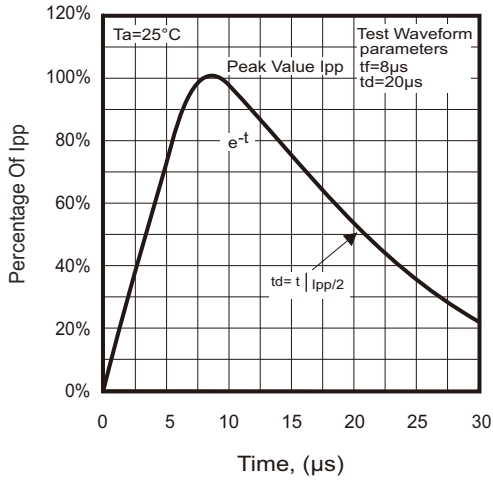

Fig.2 - Power Rating Derating Curve

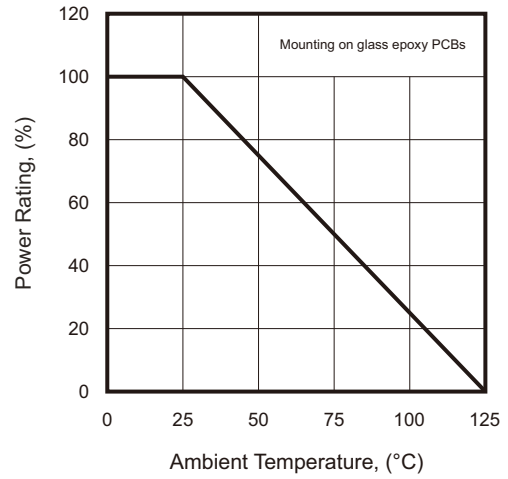

Fig.3 - Clamping Voltage Vs. Peak Pulse Current

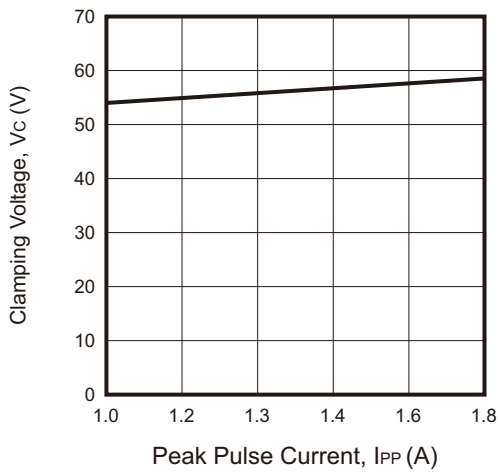
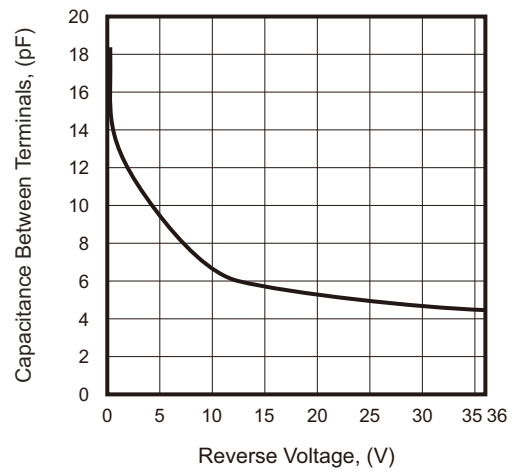
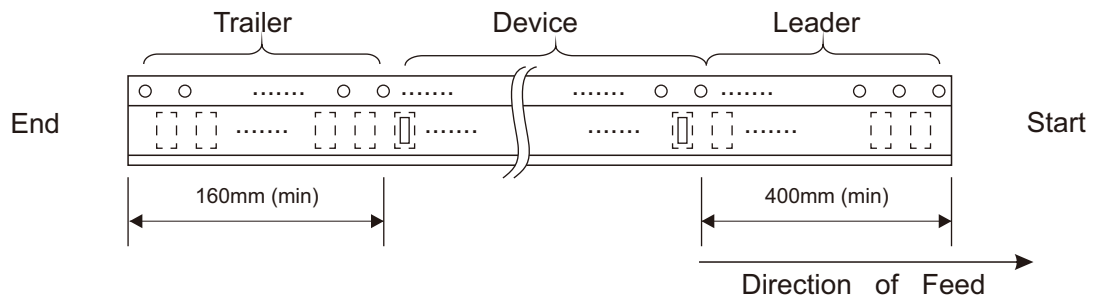
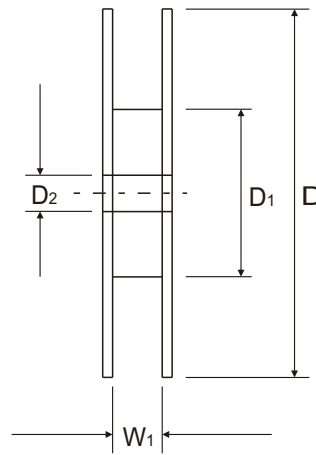
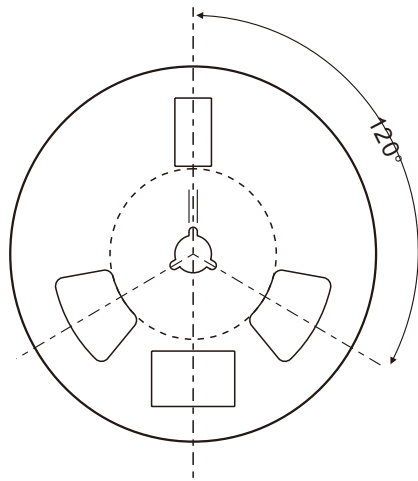
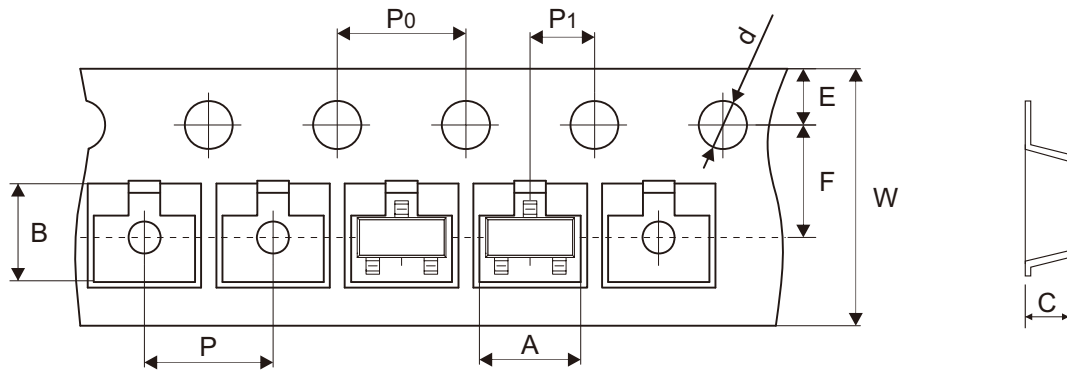

Fig.4 - Capacitance Between Terminals Characteristics



Reel Taping Specification



SOT-23	SYMBOL	A	B	C	d	D	D1	D2
	(mm)	3.15 ± 0.10	2.77 ± 0.10	1.22 ± 0.10	1.50 ± 0.10	178.00 ± 1.00	54.00 ± 0.50	13.00 ± 0.50
	(inch)	0.124 ± 0.004	0.109 ± 0.004	0.048 ± 0.004	0.059 ± 0.004	7.008 ± 0.039	2.126 ± 0.020	0.512 ± 0.020

SOT-23	SYMBOL	E	F	P	P0	P1	W	W1
	(mm)	1.75 ± 0.10	3.50 ± 0.05	4.00 ± 0.10	4.00 ± 0.10	2.00 ± 0.05	8.00 + 0.30 - 0.10	9.50 ± 1.00
	(inch)	0.069 ± 0.004	0.138 ± 0.002	0.157 ± 0.004	0.157 ± 0.004	0.079 ± 0.002	0.315 + 0.012 - 0.004	0.374 ± 0.039

Marking Code

Part Number	Marking Code
ACPDT-36VEU-HF	E36

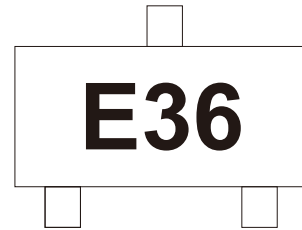

Suggested P.C.B. PAD Layout

SIZE	SOT-23	
	(mm)	(inch)
A	0.90	0.035
B	0.80	0.031
C	0.95	0.037
D	2.00	0.079

Note: 1. The pad layout is for reference purposes only.

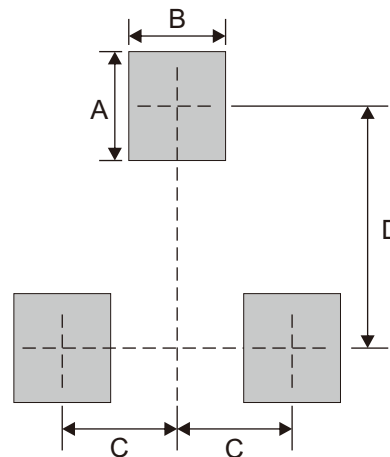

Standard Packaging

Case Type	REEL PACK	
	REEL (pcs)	Reel Size (inch)
SOT-23	3,000	7