

## MAX17536

# 4.5V to 60V, 4A, High-Efficiency, Synchronous Step-Down DC-DC Converter with Internal Compensation

### General Description

The MAX17536 high-efficiency, high-voltage, synchronous step-down DC-DC converter with integrated high-side MOSFET operates over a 4.5V to 60V input. The converter can deliver up to 4A and generates output voltages from 0.9V up to  $0.9 \times V_{IN}$ . The feedback (FB) voltage is accurate to within  $\pm 1.4\%$  over  $-40^\circ\text{C}$  to  $+125^\circ\text{C}$ .

The MAX17536 uses peak current-mode control. The device can be operated in the pulse-width modulation (PWM), pulse-frequency modulation (PFM), and discontinuous-conduction mode (DCM) control schemes.

The device is available in a 20-pin (5mm x 5mm) thin QFN (TQFN) package. Simulation models are available.

### Applications

- Industrial Power Supplies
- Distributed Supply Regulation
- Base-Station Power Supplies
- Wall Transformer Regulation
- High-Voltage Single-Board Systems
- General-Purpose Point-of-Load

**Ordering Information** appears at end of data sheet.

### Benefits and Features

- Reduces External Components and Total Cost
  - No Schottky-Synchronous Operation
  - Internal Compensation for Any Output Voltage
  - Built-In Soft-Start
  - All-Ceramic Capacitors, Compact Layout
- Reduces Number of DC-DC Regulators to Stock
  - Wide 4.5V to 60V Input
  - Adjustable Output Voltage Range from 0.9V up to 90% of  $V_{IN}$
  - 100kHz to 2.2MHz Adjustable Switching Frequency with External Synchronization
- Reduces Power Dissipation
  - Peak Efficiency > 95%
  - PFM/DCM Modes Enables Enhanced Light-Load Efficiency
  - Auxiliary Bootstrap LDO for Improved Efficiency
  - 3.5 $\mu\text{A}$  Shutdown Current
- Operates Reliably in Adverse Industrial Environments
  - Hiccup or Latchoff Mode Overload Protection
  - DL-to-LX Short Detection Feature
  - Built-In Output-Voltage Monitoring with  $\overline{\text{RESET}}$
  - Programmable EN/UVLO Threshold
  - Monotonic Startup into Prebiased Load
  - Overtemperature Protection
  - High Industrial  $-40^\circ\text{C}$  to  $+125^\circ\text{C}$  Ambient Operating Temperature Range /  $-40^\circ\text{C}$  to  $+150^\circ\text{C}$  Junction Temperature Range

### Typical Application Circuit for 5V Output

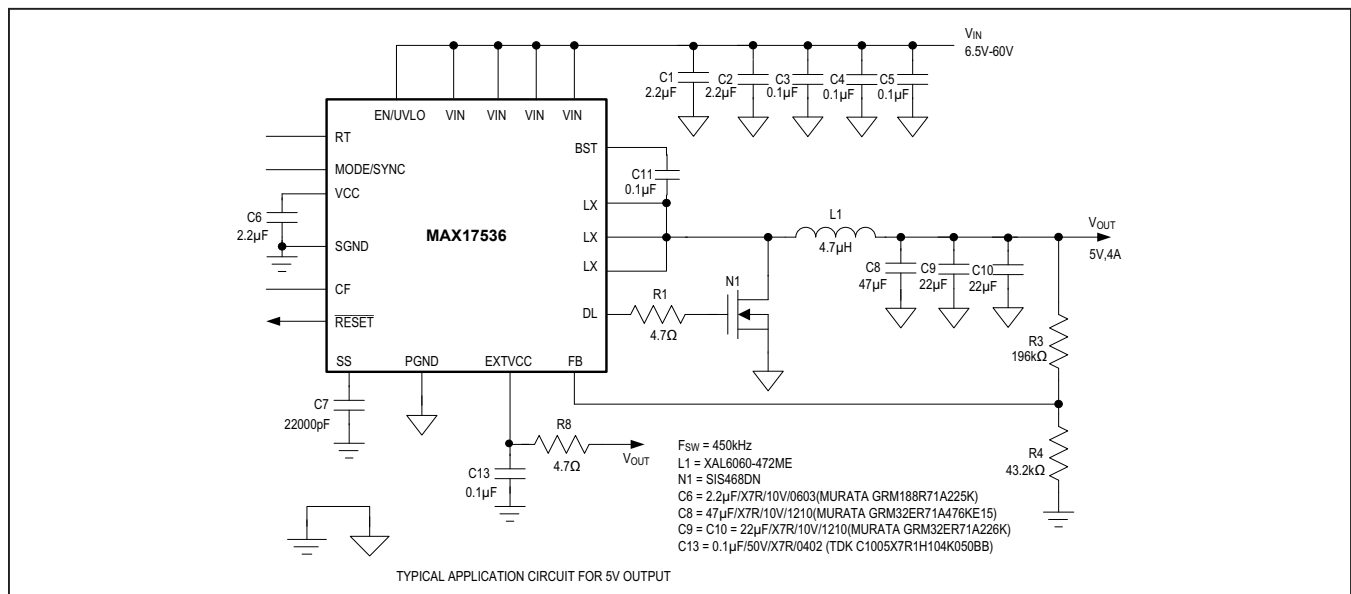

**Absolute Maximum Ratings**

$V_{IN}$ to PGND .....	-0.3V to +65V	LX Total RMS Current .....	±9.9A
EN/UVLO, SS to SGND .....	-0.3V to +65V	Output Short-Circuit Duration .....	Continuous
LX to PGND.....	-0.3V to ( $V_{IN} + 0.3V$ )	Continuous Power Dissipation ( $T_A = +70^{\circ}C$ ) (multilayer board)	
BST to PGND .....	-0.3V to +70V	TQFN (derate 33.3mW/°C above $T_A = +70^{\circ}C$ ).....	2666.7mW
BST to LX.....	-0.3V to +6.5V	Operating Temperature Range (Note 1).....	-40°C to +125°C
BST to $V_{CC}$ .....	-0.3V to +65V	Junction Temperature.....	+150°C
FB, CF, RESET, MODE/SYNC, RT to SGND .....	-0.3V to +6.5V	Storage Temperature Range.....	-65°C to +160°C
DL, $V_{CC}$ to PGND .....	-0.3V to +6.5V	Lead Temperature (soldering, 10s) .....	+300°C
SGND to PGND.....	-0.3V to +0.3V	Soldering Temperature (reflow).....	+260°C
EXTVCC to PGND .....	-0.3V to +26V		

Stresses beyond those listed under "Absolute Maximum Ratings" may cause permanent damage to the device. These are stress ratings only, and functional operation of the device at these or any other conditions beyond those indicated in the operational sections of the specifications is not implied. Exposure to absolute maximum rating conditions for extended periods may affect device reliability.

**Package Information**

<b>PACKAGE TYPE: 20 TQFN-EP*</b>	
Package Code	T2055+4
Outline Number	<a href="#">21-0140</a>
Land Pattern Number	<a href="#">90-0009</a>
<b>THERMAL RESISTANCE, FOUR-LAYER BOARD: (Note 2)</b>	
Junction to Ambient ( $\theta_{JA}$ )	23°C/W
Junction to Case ( $\theta_{JC}$ )	2°C/W

For the latest package outline information and land patterns (footprints), go to [www.maximintegrated.com/packages](http://www.maximintegrated.com/packages). Note that a "+", "#", or "-" in the package code indicates RoHS status only. Package drawings may show a different suffix character, but the drawing pertains to the package regardless of RoHS status.

- Note 1:** Junction temperature greater than +125°C degrades operating lifetimes
- Note 2:** Applicable only to the Evaluation Kit in free space with no airflow.

**Electrical Characteristics**

( $V_{IN} = V_{EN/UVLO} = 24V$ ,  $R_{RT} = \text{open}$  (450kHz),  $C_{VCC} = 2.2\mu F$ ,  $V_{PGND} = V_{SGND} = V_{MODE/SYNC} = 0V$ ,  $LX = SS = \overline{RESET} = \text{open}$ ,  $V_{BST}$  to  $V_{LX} = 5V$ ,  $V_{FB} = 1V$ ,  $T_A = -40^{\circ}C$  to  $+125^{\circ}C$ , unless otherwise noted. Typical values are at  $T_A = +25^{\circ}C$ . All voltages are referenced to SGND, unless otherwise noted.) (Note 3)

PARAMETER	SYMBOL	CONDITIONS	MIN	TYP	MAX	UNITS
<b>INPUT SUPPLY (<math>V_{IN}</math>)</b>						
Input Voltage Range	$V_{IN}$		4.5		60	V
Input Shutdown Current	$I_{IN-SH}$	$V_{EN/UVLO} = 0V$ (shutdown mode)		3.5	5.5	$\mu A$
Input Quiescent Current	$I_{Q\_PFM}$	$V_{FB} = 1V$ , MODE = RT= open		128		
		$V_{FB} = 1V$ , MODE = open, $R_{RT} = 40.2k\Omega$		168		
	$I_{Q\_DCM}$	DCM mode, $V_{LX} = 0.1V$		1.27	2	mA
<b>ENABLE/UVLO (EN/UVLO)</b>						
EN/UVLO Threshold	$V_{ENR}$	$V_{EN/UVLO}$ rising	1.19	1.215	1.24	V
	$V_{ENF}$	$V_{EN/UVLO}$ falling	1.068	1.09	1.112	
EN/UVLO Input Leakage Current	$I_{EN}$	$V_{EN/UVLO} = 1.245V$ , $T_A = +25^{\circ}C$	-50	0	+50	nA

## Electrical Characteristics

( $V_{IN} = V_{EN}/UVLO = 24V$ ,  $R_{RT} = \text{open}$  (450kHz),  $C_{VCC} = 2.2\mu F$ ,  $V_{PGND} = V_{SGND} = V_{MODE}/SYNC = 0V$ ,  $LX = SS = \overline{RESET} = \text{open}$ ,  $V_{BST}$  to  $V_{LX} = 5V$ ,  $V_{FB} = 1V$ ,  $T_A = -40^\circ C$  to  $+125^\circ C$ , unless otherwise noted. Typical values are at  $T_A = +25^\circ C$ . All voltages are referenced to  $SGND$ , unless otherwise noted.) (Note 3)

PARAMETER	SYMBOL	CONDITIONS	MIN	TYP	MAX	UNITS
<b>LDO</b>						
$V_{CC}$ Output Voltage Range	$V_{CC}$	$6V < V_{IN} < 60V$ , $I_{VCC} = 1mA$	4.75	5	5.25	V
		$1mA \leq I_{VCC} \leq 45mA$				
$V_{CC}$ Current Limit	$I_{VCC-MAX}$	$V_{CC} = 4.3V$ , $V_{IN} = 6V$	50	90	140	mA
$V_{CC}$ Dropout	$V_{CC-DO}$	$V_{IN} = 4.5V$ , $I_{VCC} = 45mA$	4.1			V
$V_{CC}$ UVLO	$V_{CC\_UVR}$	$V_{CC}$ rising	4.1	4.2	4.3	V
	$V_{CC\_UVF}$	$V_{CC}$ falling	3.7	3.8	3.9	
<b>EXT LDO</b>						
EXT $V_{CC}$ Switchover Voltage		EXT $V_{CC}$ rising	4.56	4.7	4.84	V
EXT $V_{CC}$ Operating Voltage Range			4.84		24	V
EXT $V_{CC}$ Switchover Voltage Hysteresis			0.205	0.232	0.255	V
EXT $V_{CC}$ Dropout	EXT $V_{CC-DO}$	$V_{EXTVCC} = 4.75V$ , $I_{EXTVCC} = 45mA$			0.4	V
EXT $V_{CC}$ Current Limit	EXT $I_{VCC-MAX}$	$V_{CC} = 4.3V$ , EXT $V_{CC} = 5V$	45	85	140	mA
<b>POWER MOSFET AND LOW-SIDE DRIVER</b>						
High-Side nMOS On-Resistance	$R_{DS-ONH}$	$I_{LX} = 1.0A$		45	90	m $\Omega$
LX Leakage Current	$I_{LX\_LKG}$	$V_{LX} = V_{IN} - 1V$ , $V_{LX} = V_{PGND} + 1V$ , $T_A = +25^\circ C$	-4	1	+4	$\mu A$
DL Pullup Resistance		$I_{SOURCE} = 100mA$		1.9	2.9	$\Omega$
DL Pulldown Resistance		$I_{SINK} = 100mA$		1	1.65	$\Omega$
<b>SOFT-START (SS)</b>						
Charging Current	$I_{SS}$	$V_{SS} = 0V$	4.7	5	5.3	$\mu A$
<b>FEEDBACK (FB)</b>						
FB Regulation Voltage	$V_{FB\_REG}$	MODE = SGND or MODE = $V_{CC}$	0.887	0.9	0.912	V
		MODE = open	0.887	0.915	0.936	
FB Input Bias Current	$I_{FB}$	$0 < V_{FB} < 1V$ , $T_A = +25^\circ C$	-75		+75	nA
<b>MODE/SYNC</b>						
MODE Threshold	$V_{M-DCM}$	MODE = $V_{CC}$ (DCM mode)	$V_{CC} - 0.6$		V	
	$V_{M-PFM}$	MODE = open (PFM mode)	$V_{CC}/2$			
	$V_{M-PWM}$	MODE = GND (PWM mode)	0.6			
SYNC Frequency Capture Range		$f_{SW}$ set by $R_{RT}$	1.1 x $f_{SW}$		1.4 x $f_{SW}$	kHz
SYNC Pulse Width			50			ns
SYNC Threshold	$V_{IH}$		2.0			V
	$V_{IL}$				0.8	

## Electrical Characteristics

( $V_{IN} = V_{EN}/UVLO = 24V$ ,  $R_{RT} = \text{open}$  (450kHz),  $C_{VCC} = 2.2\mu F$ ,  $V_{PGND} = V_{SGND} = V_{MODE}/SYNC = 0V$ ,  $LX = SS = \overline{RESET} = \text{open}$ ,  $V_{BST}$  to  $V_{LX} = 5V$ ,  $V_{FB} = 1V$ ,  $T_A = -40^\circ C$  to  $+125^\circ C$ , unless otherwise noted. Typical values are at  $T_A = +25^\circ C$ . All voltages are referenced to  $SGND$ , unless otherwise noted.) (Note 3)

PARAMETER	SYMBOL	CONDITIONS	MIN	TYP	MAX	UNITS	
<b>CURRENT LIMIT</b>							
Peak Current-Limit Threshold	$I_{PEAK-LIMIT}$	$R_{DL} = \text{open}$ or $R_{DL} = 174k\Omega$	5.45	6.5	7.55	A	
		$R_{DL} = 61.9k\Omega$ or $R_{DL} = 26.1k\Omega$	4.05	5	5.95	A	
Runaway Current-Limit Threshold	$I_{RUNAWAY-LIMIT}$	$R_{DL} = \text{open}$ or $R_{DL} = 174k\Omega$	6.25	7.5	8.75	A	
		$R_{DL} = 61.9k\Omega$ or $R_{DL} = 26.1k\Omega$	5	6	7	A	
Negative Current-Limit Comparator Voltage Reference		MODE = open or MODE = $V_{CC}$	0			mV	
		MODE = GND	42	50	58		
PFM Current-Limit Threshold	$I_{PFM}$	MODE = open	2			A	
<b>RT</b>							
Switching Frequency	$f_{SW}$	$R_{RT} = 196k\Omega$	90	100	110	kHz	
		$R_{RT} = 93.1k\Omega$	180	200	220		
		$R_{RT} = \text{open}$	420	450	480		
		$R_{RT} = 6.98k\Omega$	1950	2200	2450		
$V_{FB}$ Undervoltage Trip Level to Cause Hiccup	$V_{FB-HICF}$		0.56	0.58	0.61	V	
HICCUP Timeout		(Note 3)	32768			Cycles	
Minimum On-Time	$t_{ON-MIN}$		95			160	ns
Minimum Off-Time	$t_{OFF-MIN}$		140			160	ns
LX Dead Time			22			ns	
<b>RESET</b>							
$\overline{RESET}$ Output Level Low		$I_{RESET} = 10mA$	0.200			V	
$\overline{RESET}$ Output Leakage Current		$T_A = T_J = +25^\circ C$ , $V_{RESET} = 5.5V$	-0.1			+0.1	$\mu A$
$V_{OUT}$ Threshold for $\overline{RESET}$ Assertion	$V_{FB-OKF}$	$V_{FB}$ falling	90.4	92.5	94.6	%	
$V_{OUT}$ Threshold for $\overline{RESET}$ Deassertion	$V_{FB-OKR}$	$V_{FB}$ rising	93.4	95.5	97.7	%	
$\overline{RESET}$ Deassertion Delay After FB Reaches 95% Regulation			1024			Cycles	
<b>THERMAL SHUTDOWN</b>							
Thermal-Shutdown Threshold		Temperature rising	165			$^\circ C$	
Thermal-Shutdown Hysteresis			10			$^\circ C$	

**Note 3:** All electrical specifications are 100% production tested at  $T_A = +25^\circ C$ . Specifications over the operating temperature range are guaranteed by design and characterization.

**Note 4:** See the [Overcurrent Protection/Hiccup Mode](#) section for more details.

Typical Operating Characteristics

( $V_{IN} = V_{EN}/UV_{LO} = 24V$ ,  $V_{PGND} = V_{SGND} = 0V$ ,  $C_{VIN} = 2 \times 2.2\mu F$ ,  $C_{VCC} = 2.2\mu F$ ,  $C_{BST} = 0.1\mu F$ ,  $C_{SS} = 22,000pF$ ,  $RT = MODE/SYNC = open$ ,  $T_A = -40^{\circ}C$  to  $+125^{\circ}C$ , unless otherwise noted. Typical values are at  $T_A = +25^{\circ}C$ . All voltages are referenced to SGND, unless otherwise noted.)

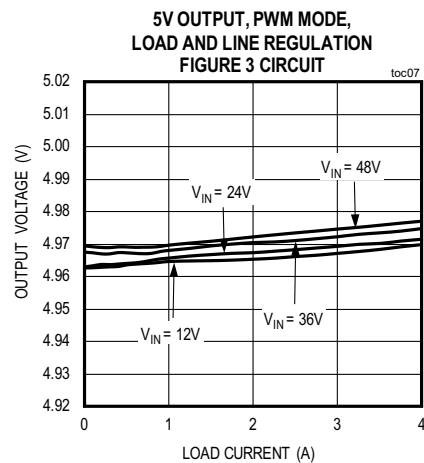
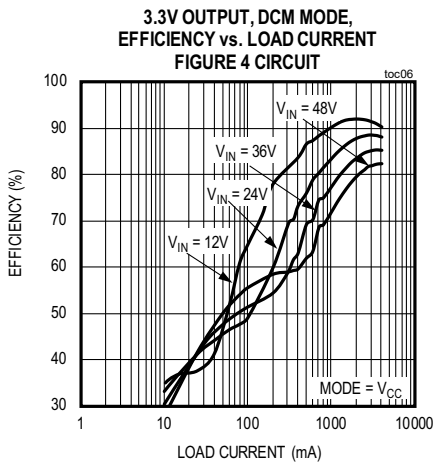
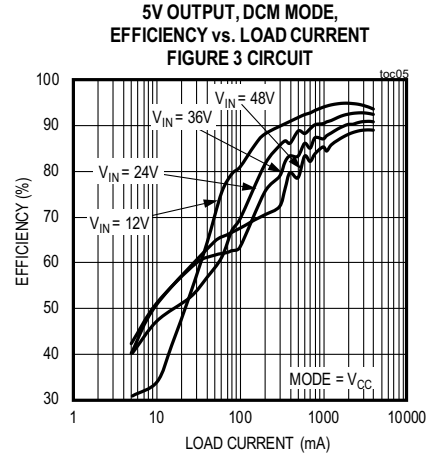
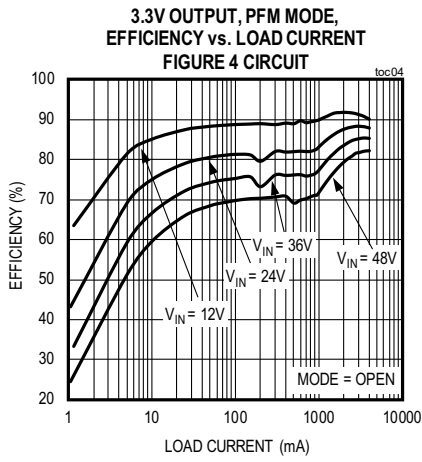
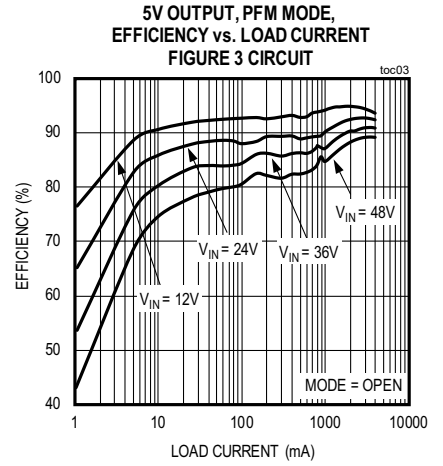
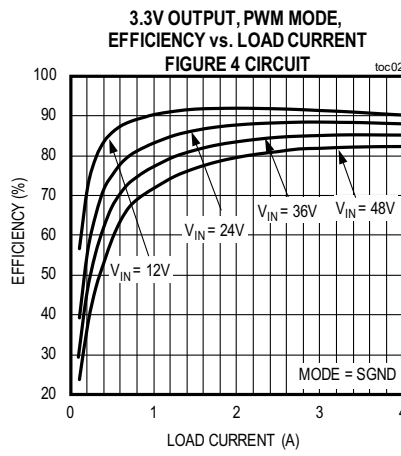
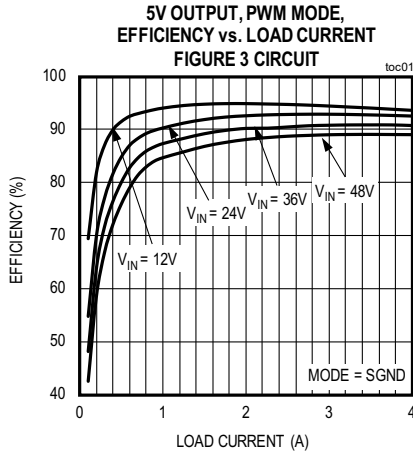

Typical Operating Characteristics

( $V_{IN} = V_{EN}/UVLO = 24V$ ,  $V_{PGND} = V_{SGND} = 0V$ ,  $C_{VIN} = 2 \times 2.2\mu F$ ,  $C_{VCC} = 2.2\mu F$ ,  $C_{BST} = 0.1\mu F$ ,  $C_{SS} = 22,000pF$ ,  $RT = MODE/SYNC = \text{open}$ ,  $T_A = -40^\circ C$  to  $+125^\circ C$ , unless otherwise noted. Typical values are at  $T_A = +25^\circ C$ . All voltages are referenced to SGND, unless otherwise noted.)

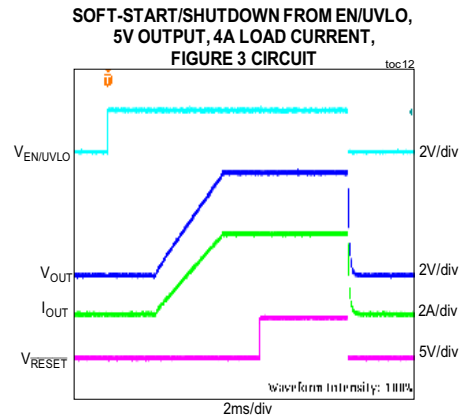
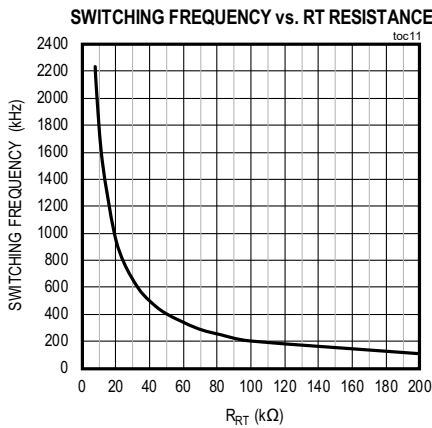
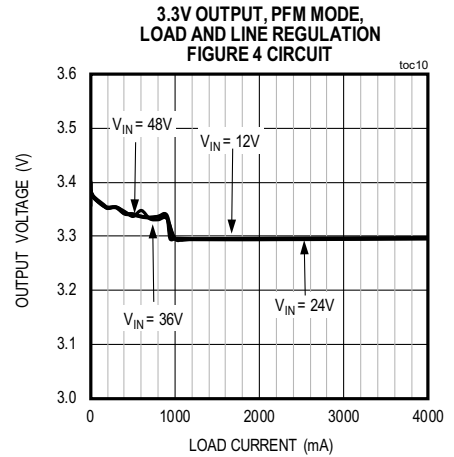
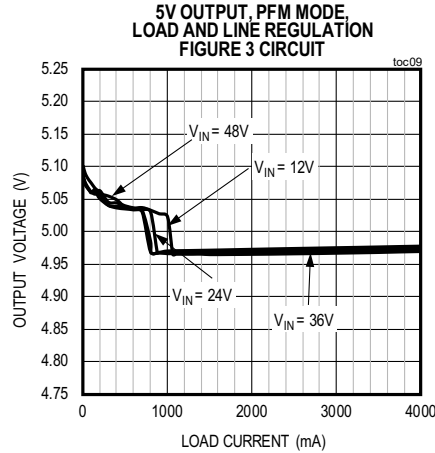
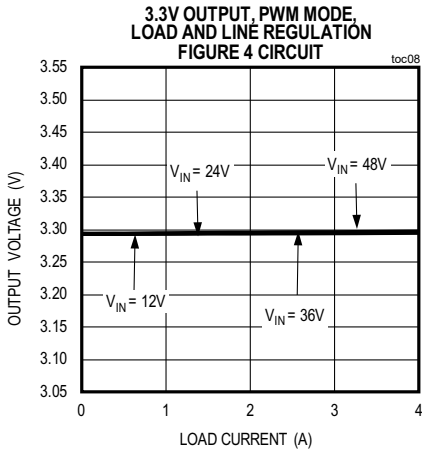

CONDITION:  $\overline{RESET}$  IS PULLED UP TO  $V_{CC}$  WITH A 10kΩ RESISTOR

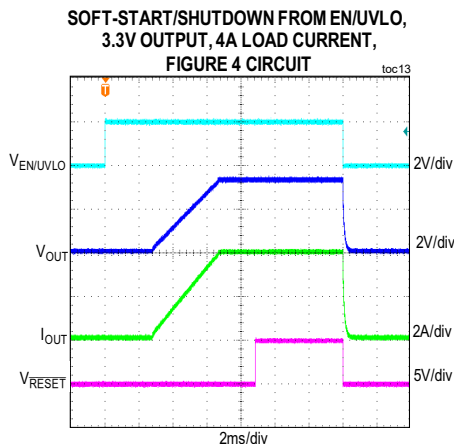

CONDITION:  $\overline{RESET}$  IS PULLED UP TO  $V_{CC}$  WITH A 10kΩ RESISTOR

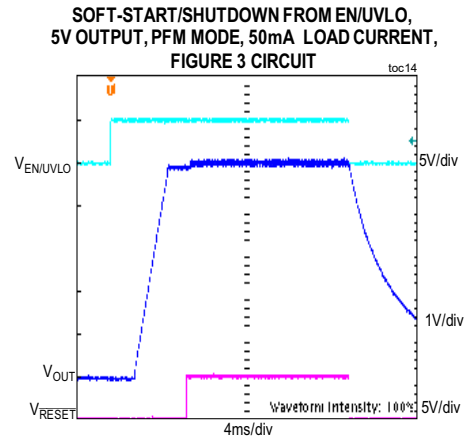

CONDITION:  $\overline{RESET}$  IS PULLED UP TO  $V_{CC}$  WITH A 10kΩ RESISTOR

Typical Operating Characteristics

( $V_{IN} = V_{EN/UVLO} = 24V$ ,  $V_{PGND} = V_{SGND} = 0V$ ,  $C_{VIN} = 2 \times 2.2\mu F$ ,  $C_{VCC} = 2.2\mu F$ ,  $C_{BST} = 0.1\mu F$ ,  $C_{SS} = 22,000pF$ ,  $RT = MODE/SYNC = \text{open}$ ,  $T_A = -40^\circ C$  to  $+125^\circ C$ , unless otherwise noted. Typical values are at  $T_A = +25^\circ C$ . All voltages are referenced to SGND, unless otherwise noted.)

SOFT-START/SHUTDOWN FROM EN/UVLO, 3.3V OUTPUT, PFM MODE, 50mA LOAD CURRENT, FIGURE 4 CIRCUIT

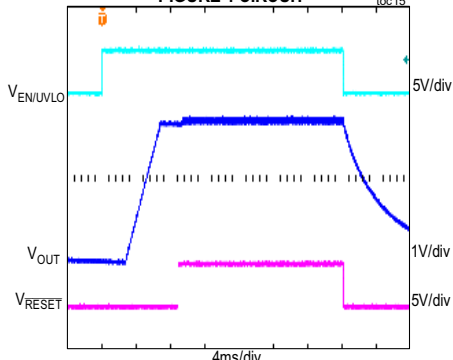

CONDITION:  $\overline{RESET}$  IS PULLED UP TO  $V_{CC}$  WITH A 10kΩ RESISTOR

SOFT-START WITH 2.5V PREBIAS, 5V OUTPUT, PWM MODE, FIGURE 3 CIRCUIT

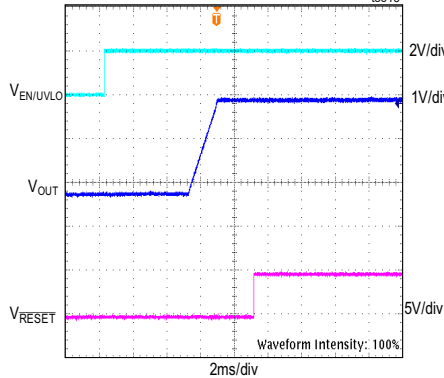

CONDITION:  $\overline{RESET}$  IS PULLED UP TO  $V_{CC}$  WITH A 10kΩ RESISTOR

SOFT-START WITH 2.5V PREBIAS, 3.3V OUTPUT, PWM MODE, FIGURE 4 CIRCUIT

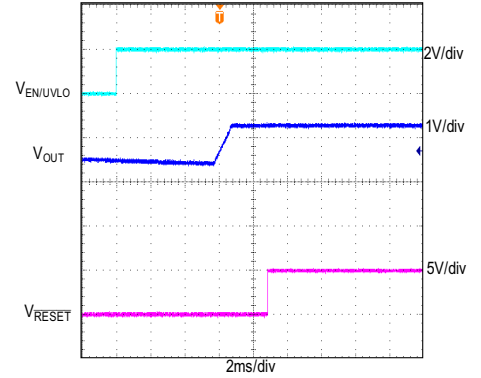

CONDITION:  $\overline{RESET}$  IS PULLED UP TO  $V_{CC}$  WITH A 10kΩ RESISTOR

STEADY-STATE SWITCHING WAVEFORMS, 5V OUTPUT, 4A LOAD CURRENT, FIGURE 3 CIRCUIT

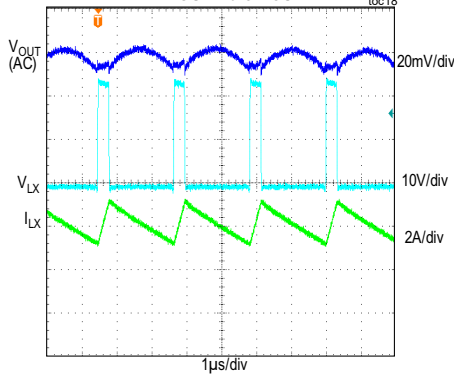

STEADY-STATE SWITCHING WAVEFORMS, 5V OUTPUT, NO LOAD CURRENT, FIGURE 3 CIRCUIT

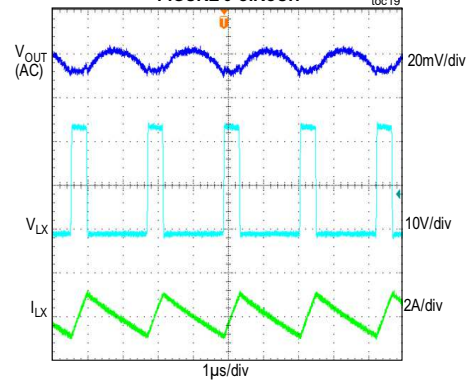

STEADY-STATE SWITCHING WAVEFORMS, 5V OUTPUT, PFM MODE, 25mA LOAD CURRENT, FIGURE 3 CIRCUIT

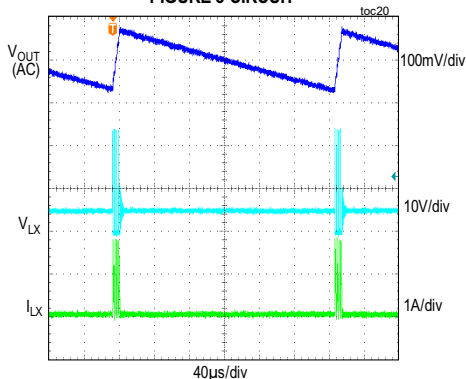

STEADY-STATE SWITCHING WAVEFORMS, 5V OUTPUT, DCM MODE, 25mA LOAD CURRENT, FIGURE 3 CIRCUIT

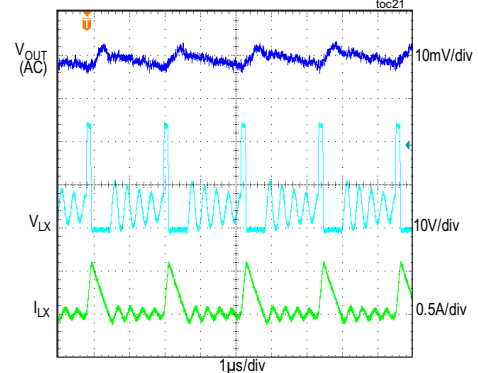

Typical Operating Characteristics

( $V_{IN} = V_{EN}/UVLO = 24V$ ,  $V_{PGND} = V_{SGND} = 0V$ ,  $C_{VIN} = 2 \times 2.2\mu F$ ,  $C_{VCC} = 2.2\mu F$ ,  $C_{BST} = 0.1\mu F$ ,  $C_{SS} = 22,000pF$ ,  $RT = MODE/SYNC =$  open,  $T_A = -40^\circ C$  to  $+125^\circ C$ , unless otherwise noted. Typical values are at  $T_A = +25^\circ C$ . All voltages are referenced to SGND, unless otherwise noted.)

5V OUTPUT, PWM MODE, FIGURE 3 CIRCUIT (LOAD CURRENT STEPPED FROM 2A TO 4A)

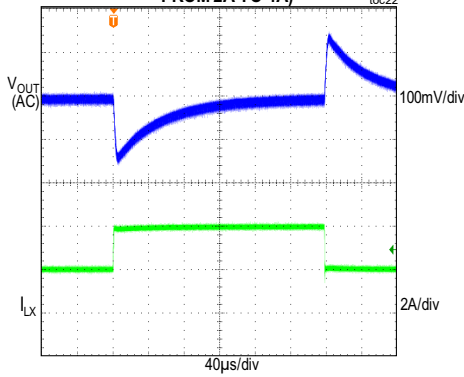

3.3V OUTPUT, PWM MODE, FIGURE 4 CIRCUIT (LOAD CURRENT STEPPED FROM 2A TO 4A)

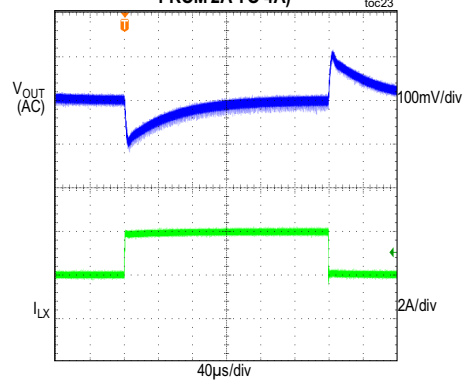

5V OUTPUT, PWM MODE, FIGURE 3 CIRCUIT (LOAD CURRENT STEPPED FROM NO LOAD TO 2A)

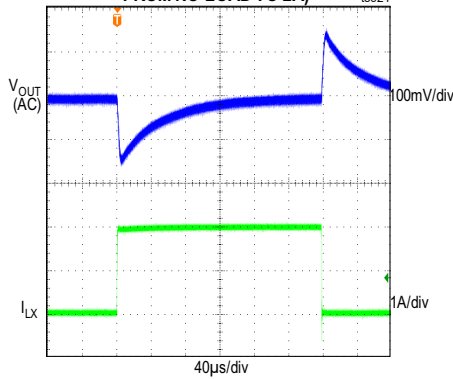

3.3V OUTPUT, PWM MODE, FIGURE 4 CIRCUIT (LOAD CURRENT STEPPED FROM NO LOAD TO 2A)

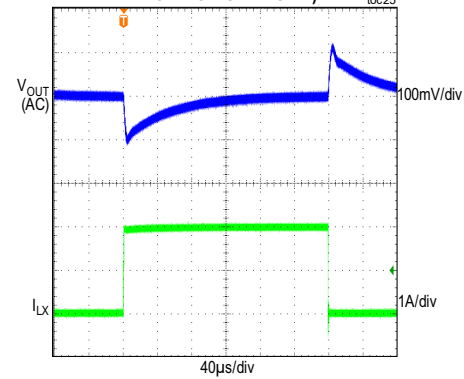

5V OUTPUT, PFM MODE, FIGURE 3 CIRCUIT (LOAD CURRENT STEPPED FROM 5mA TO 2A)

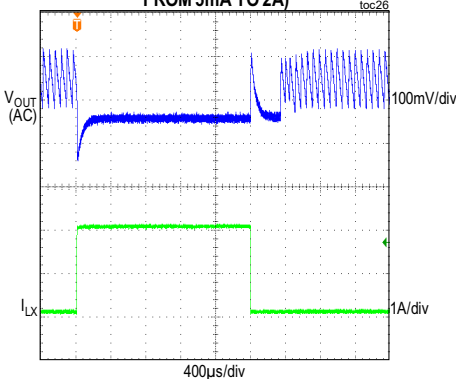

3.3V OUTPUT, PFM MODE, FIGURE 4 CIRCUIT (LOAD CURRENT STEPPED FROM 50mA TO 2A)

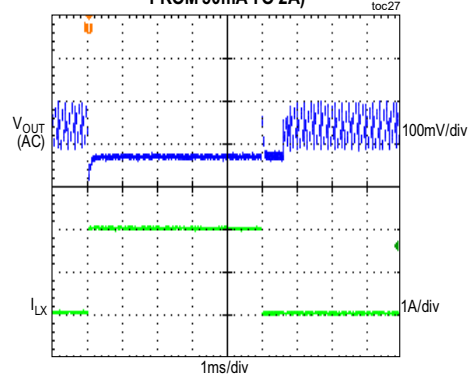



Typical Operating Characteristics

( $V_{IN} = V_{EN}/UVLO = 24V$ ,  $V_{PGND} = V_{SGND} = 0V$ ,  $C_{VIN} = 2 \times 2.2\mu F$ ,  $C_{VCC} = 2.2\mu F$ ,  $C_{BST} = 0.1\mu F$ ,  $C_{SS} = 22,000pF$ ,  $RT = MODE/SYNC$  = open,  $T_A = -40^{\circ}C$  to  $+125^{\circ}C$ , unless otherwise noted. Typical values are at  $T_A = +25^{\circ}C$ . All voltages are referenced to SGND, unless otherwise noted.)

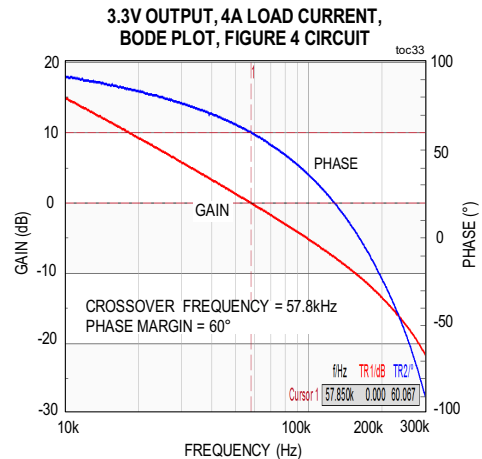
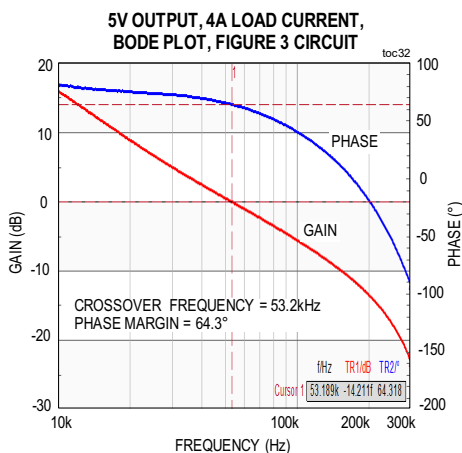
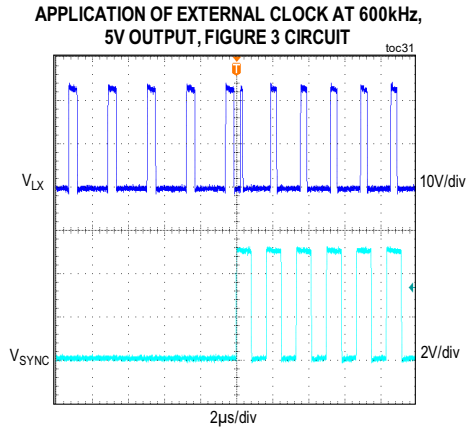
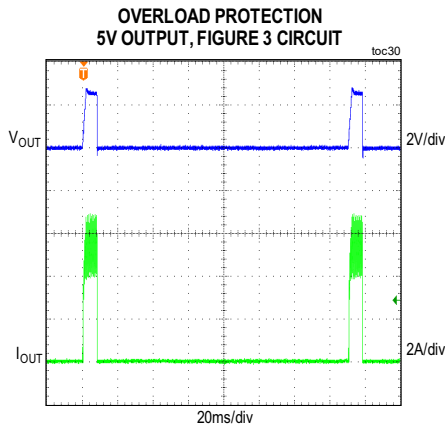
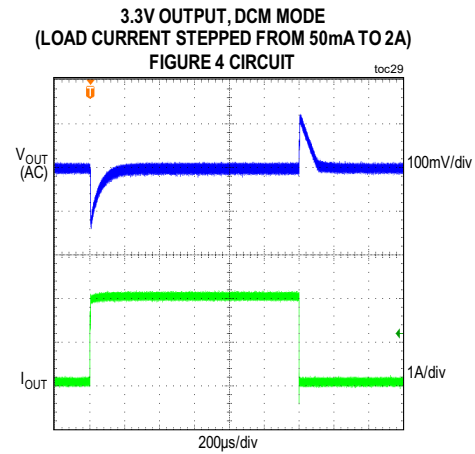
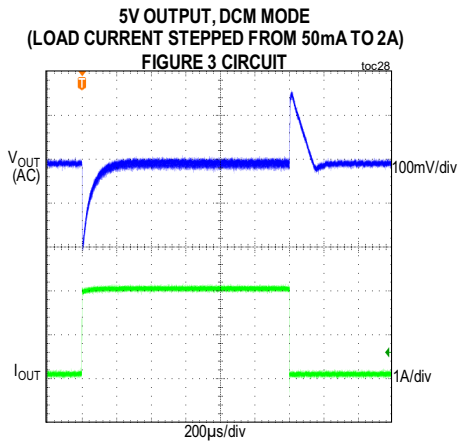

Pin Configuration

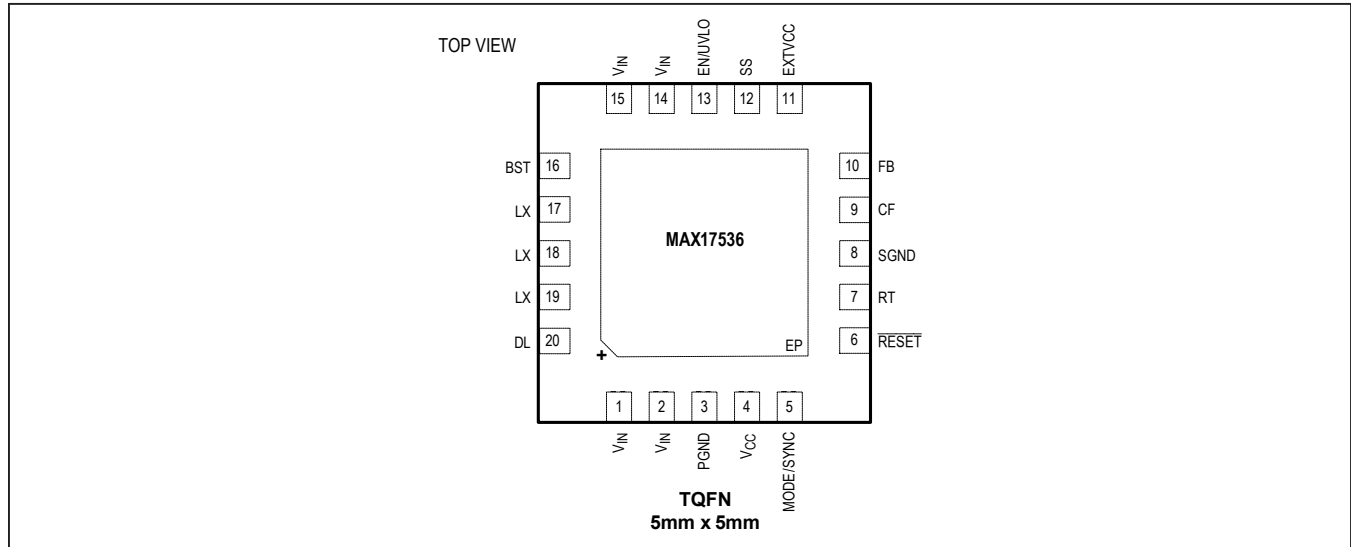

Pin Description

PIN	NAME	FUNCTION
1, 2, 14,15	V <sub>IN</sub>	Power-Supply Input. 4.5V to 60V input supply range. Connect the V <sub>IN</sub> pins together. Decouple to PGND with two 2.2μF capacitors; place the capacitors close to the V <sub>IN</sub> and PGND pins. Refer to the MAX17536 evaluation kit data sheet for a layout example.
3	PGND	Power Ground. Connect the PGND pin externally to the power-ground plane. Connect the SGND and PGND pins together at the ground return path of the V <sub>CC</sub> bypass capacitor. Refer to the MAX17536 Evaluation kit data sheet for a layout example.
4	V <sub>CC</sub>	5V LDO Output. Bypass V <sub>CC</sub> with a 2.2μF ceramic capacitance to SGND.
5	MODE/SYNC	MODE/SYNC configures the MAX17536 to operate in PWM, PFM, or DCM modes of operation. Leave MODE/SYNC unconnected for PFM operation (pulse skipping at light loads). Connect MODE/SYNC to SGND for constant-frequency PWM operation at all loads. Connect MODE/SYNC to V <sub>CC</sub> for DCM operation. The device can be synchronized to an external clock using this pin. See the <i>Mode Selection</i> section and the <i>External Frequency Synchronization</i> section for more details.
6	RESET	Open-Drain RESET Output. The RESET output is driven low if FB drops below 92.2% of its set value. RESET goes high 1024 clock cycles after FB rises above 95.6% of its set value.
7	RT	Programmable Switching Frequency Input. Connect a resistor from RT to SGND to set the regulator’s switching frequency. Leave RT open for the default 450kHz frequency. See the <i>Setting the Switching Frequency (RT)</i> section for more details.
8	SGND	Analog Ground
9	CF	At switching frequencies lower than 450kHz, connect a capacitor from CF to FB. Leave CF open if the switching frequency is equal to or more than 450kHz. See the <i>Loop Compensation</i> section for more details.
10	FB	Feedback Input. Connect FB to the center tap of an external resistor-divider from the output to SGND to set the output voltage. See the <i>Adjusting Output Voltage</i> section for more details.
11	EXTVCC	External Power-Supply Input for the Bootstrap Internal LDO. Applying a voltage between 4.84V and 24V at the EXTVCC pin draws power for the control circuits and driver from the output by bypassing the V <sub>CC</sub> internal LDO and improves efficiency. Connect EXTVCC to the Buck regulator output capacitor using an R-C filter (4.7Ω, 0.1μF). Bypass the EXTVCC pin to SGND (see Figure 3). Connect the EXTVCC pin to SGND when the pin is not being used.

Pin Description (continued)

PIN	NAME	FUNCTION
12	SS	Soft-Start Input. Connect a capacitor from SS to SGND to set the soft-start time.
13	EN/UVLO	Enable/Undervoltage Lockout. Drive EN/UVLO high to enable the output voltage. Connect to the center of the resistor-divider between $V_{IN}$ and SGND to set the input voltage at which the MAX17536 turns on. Pull up to $V_{IN}$ for always-on operation.
16	BST	Boost Flying Capacitor. Connect a 0.1 $\mu$ F ceramic capacitor between BST and LX.
17–19	LX	Switching Node. Connect LX pins to the switching side of the inductor.
20	DL	Use DL pin to drive the gate of the low-side external nMOSFET. A resistor connected between the DL pin and SGND selects the overload-protection method and the peak and runaway current limits. Connect a 4.7 $\Omega$ resistor between the DL pin and the gate of the low-side external nMOSFET. See the <i>Overcurrent Protection/Hiccup Mode</i> section for more details.
—	EP	Always connect EP to the SGND pin of the IC. Also, connect EP to a large SGND plane with several thermal vias for best Thermal performance. Refer to the MAX17536 EV kit data sheet for an example of the correct method for EP connection and thermal vias.

Block Diagram

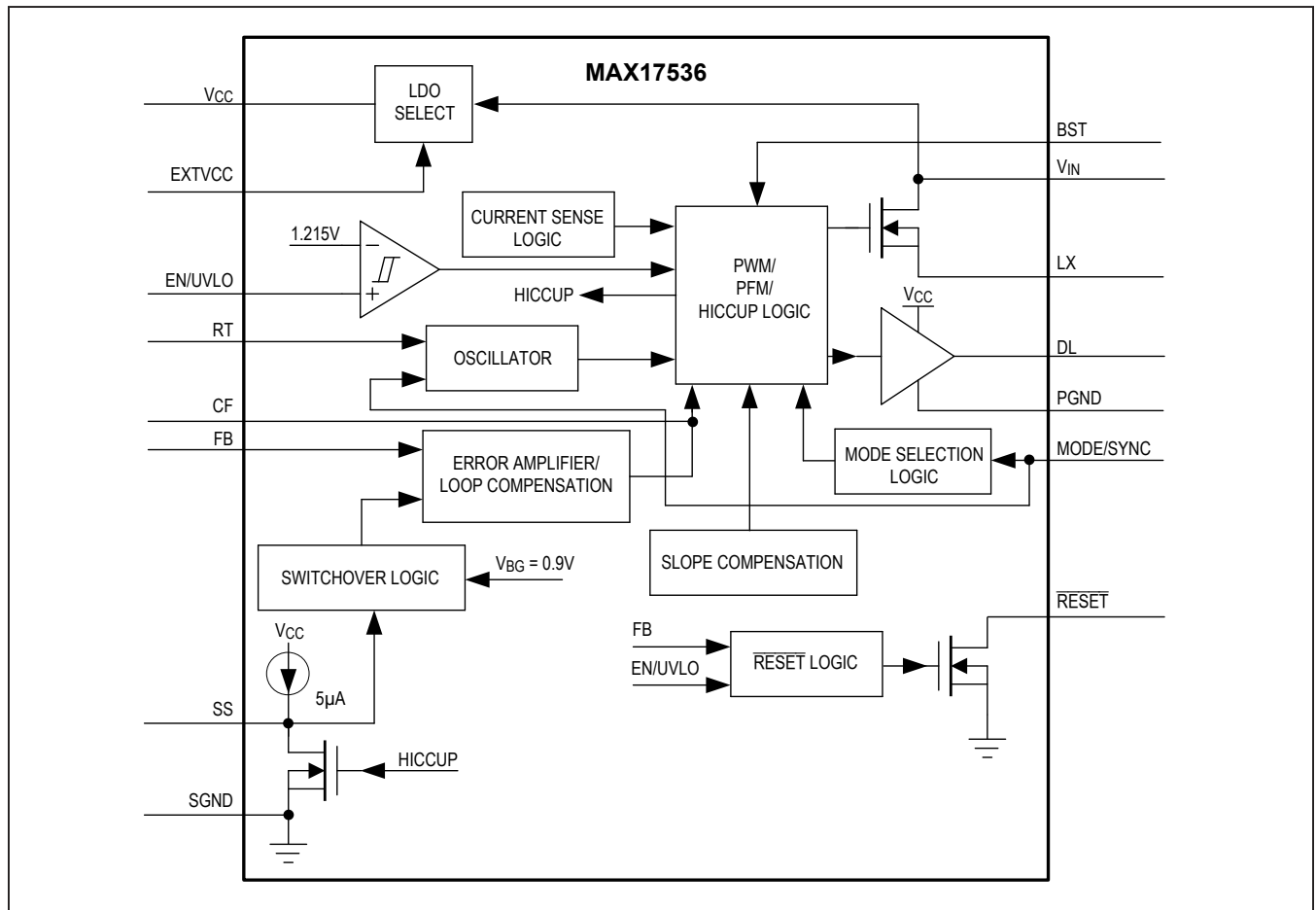

## Detailed Description

The MAX17536 high-efficiency, high-voltage, synchronously rectified step-down converter with integrated high-side MOSFET operates over a 4.5V to 60V input. It delivers up to 4A and 0.9V up to 90%  $V_{IN}$  output voltage. Built-in compensation across the output voltage range eliminates the need for external components. The feedback (FB) regulation accuracy over  $-40^{\circ}\text{C}$  to  $+125^{\circ}\text{C}$  is  $\pm 1.4\%$ .

The device features a peak-current-mode control architecture. An internal transconductance error amplifier produces an integrated error voltage at an internal node that sets the duty cycle using a PWM comparator, a high-side current-sense amplifier, and a slope-compensation generator. At each rising edge of the clock, the high-side MOSFET turns on and remains on until either the appropriate or maximum duty cycle is reached, or the peak current limit is detected. During the high-side MOSFET's on-time, the inductor current ramps up. During the second-half of the switching cycle, the high-side MOSFET turns off and the low-side MOSFET turns on. The inductor releases the stored energy as its current ramps down and provides current to the output.

The device features a MODE/SYNC pin that can be used to operate the device in PWM, PFM, or DCM control schemes and to synchronize the switching frequency to an external clock. The device also features adjustable-input undervoltage lockout, adjustable soft-start, open-drain RESET, auxiliary bootstrap LDO, and DL-to-LX short-detection features.

## Mode Selection (MODE)

The logic state of the MODE/SYNC pin is latched when  $V_{CC}$  and EN/UVLO voltages exceed the respective UVLO rising thresholds and all internal voltages are ready to allow LX switching. If the MODE/SYNC pin is open at power-up, the device operates in PFM mode at light loads. If the MODE/SYNC pin is grounded at power-up, the device operates in constant-frequency PWM mode at all loads. Finally, if the MODE/SYNC pin is connected to  $V_{CC}$  at power-up, the device operates in constant-frequency DCM mode at light loads. State changes on the MODE/SYNC pin are ignored during normal operation.

## PWM Mode Operation

In PWM mode, the inductor current is allowed to go negative. PWM operation provides constant frequency operation at all loads, and is useful in applications sensitive to switching frequency. However, the PWM mode of operation gives lower efficiency at light loads compared to PFM and DCM modes of operation.

## PFM Mode Operation

PFM mode of operation disables negative inductor current and additionally skips pulses at light loads for high efficiency. In PFM mode, the inductor current is forced to a fixed peak of 2A every clock cycle until the output rises to 102.3% of the nominal voltage. Once the output reaches 102.3% of the nominal voltage, both the high-side and low-side FETs are turned off and the device enters hibernate operation until the load discharges the output to 101.1% of the nominal voltage. Most of the internal blocks are turned off in hibernate operation to save quiescent current. After the output falls below 101.1% of the nominal voltage, the device comes out of hibernate operation, turns on all internal blocks, and again commences the process of delivering pulses of energy to the output until it reaches 102.3% of the nominal output voltage.

The advantage of the PFM mode is higher efficiency at light loads because of lower quiescent current drawn from the supply. The disadvantage is that the output-voltage ripple is higher compared to PWM or DCM modes of operation and switching frequency is not constant at light loads.

## DCM Mode Operation

DCM mode of operation features constant-frequency operation down to lighter loads than PFM mode, by not skipping pulses but only disabling negative inductor current at light loads. DCM operation offers efficiency performance that lies between PWM and PFM modes.

## Linear Regulator ( $V_{CC}$ and EXT $V_{CC}$ )

The device has two internal LDO (low-dropout) regulators which powers  $V_{CC}$ . One LDO is powered from  $V_{IN}$  (IN LDO) and the other LDO is powered from EXT $V_{CC}$  (EXT $V_{CC}$  LDO). Only one of the two LDOs is in operation at a time, depending on the voltage levels present at EXT $V_{CC}$ . If EXT $V_{CC}$  voltage is greater than 4.7V (typ),  $V_{CC}$  is powered from EXT $V_{CC}$ . If EXT $V_{CC}$  is lower than 4.7V (typ),  $V_{CC}$  is powered from  $V_{IN}$ . Powering  $V_{CC}$  from EXT $V_{CC}$  increases efficiency at higher input voltages. EXT $V_{CC}$  voltage should not exceed 24V.

Typical  $V_{CC}$  output voltage is 5V. Bypass  $V_{CC}$  to SGND with a 2.2 $\mu\text{F}$  low-ESR ceramic capacitor.  $V_{CC}$  powers the internal blocks and the low-side MOSFET driver and re-charges the external bootstrap capacitor. Both INLDO and EXT $V_{CC}$  LDO can source up to 45mA for bias requirements. The MAX17536 employs an undervoltage-lockout circuit that forces the converter off when  $V_{CC}$  falls below 3.8V (typ). The converter is enabled again when  $V_{CC} > 4.2\text{V}$ . The 400mV UVLO hysteresis prevents chattering on power-up/power-down.

Add a local bypassing cap of 0.1µF on the EXTVCC pin to SGND. Also, add a 4.7Ω resistor from buck converter output node to the EXTVCC pin to limit VCC bypass cap discharge current and to protect the EXTVCC pin from reaching its absolute maximum rating (-0.3V) during output short-circuit condition. In applications where the buck converter output is connected to the EXTVCC pin, if the output is shorted to ground, the transfer from EXTVCC LDO to IN LDO happens seamlessly, without any impact on the normal functionality. Connect EXTVCC pin to SGND when the pin is not being used.

### Setting the Switching Frequency (RT)

The switching frequency of the MAX17536 can be programmed from 100kHz to 2.2MHz by using a resistor connected from RT to SGND. The switching frequency ( $f_{SW}$ ) is related to the resistor connected at the RT pin ( $R_{RT}$ ) by the following equation:

$$R_{RT} \cong \frac{19 \times 10^3}{f_{SW}} - 1.7$$

where  $R_{RT}$  is in kΩ and  $f_{SW}$  is in kHz. Leaving the RT pin open causes the device to operate at the default switching frequency of 450kHz. See [Table 1](#) for RT resistor values for a few common switching frequencies.

### Operating Input Voltage Range

The minimum and maximum operating input voltages for a given output voltage should be calculated as follows:

$$V_{IN(MIN)} = \frac{V_{OUT} + (I_{OUT(MAX)} \times (R_{DCR(MAX)} + R_{DS-ONL(MAX)}))}{1 - (f_{SW(MAX)} \times t_{OFF-MIN(MAX)})} + (I_{OUT(MAX)} \times (R_{DS-ONH(MAX)} - R_{DS-ONL(MAX)}))$$

$$V_{IN(MAX)} = \frac{V_{OUT}}{f_{SW(MAX)} \times t_{ON-MIN(MAX)}}$$

where:

$V_{OUT}$  = Steady-state output voltage

$I_{OUT(MAX)}$  = Maximum load current

$R_{DCR(MAX)}$  = Worst-case DC resistance of the inductor

$f_{SW(MAX)}$  = Maximum switching frequency

$t_{OFF-MIN(MAX)}$  = Worst-case minimum switch off-time (160ns)

$t_{ON-MIN(MAX)}$  = Worst-case minimum switch on-time (160ns)

$R_{DS-ONH(MAX)}$  = Worst-case on-state resistances and high-side internal MOSFET,

$R_{DS-ONL(MAX)}$  = Worst-case on-state resistances and low-side external MOSFET.

**Table 1. Switching Frequency vs. RT Resistor**

SWITCHING FREQUENCY (kHz)	RT RESISTOR (kΩ)
450	OPEN
100	96
200	93.1
2200	6.98

### External Frequency Synchronization

The internal oscillator of the device can be synchronized to an external clock signal on the MODE/SYNC pin. The external synchronization clock frequency must be between  $1.1 \times f_{SW}$  and  $1.4 \times f_{SW}$ , where  $f_{SW}$  is the frequency programmed by the RT resistor. When an external clock is applied to MODE/SYNC pin, the internal oscillator frequency changes to external clock frequency (from original frequency based on RT setting) after detecting 16 external clock edges. The converter will operate in PWM mode during synchronization operation. When MODE/SYNC is floated for PFM mode, internal 300kΩ pull-down resistor on this pin pulls the node below  $V_{IL}$  of the SYNC threshold and maintains the part in PFM mode. When the external clock is applied on the fly, the mode of operation changes to PWM from the initial state of PFM/DCM/PWM. When the external clock is removed on the fly, the internal oscillator frequency changes to the RT set frequency and the converter continues to operate in PWM mode. The minimum external clock pulse-width high should be greater than 22ns. See the [Mode Selection \(MODE\)](#) section in the [Electrical Characteristics](#) table for details.

### DL-to-LX Short Detection

In the MAX17536, the DL and LX pins are adjacent to each other. To prevent damage to the low-side external FET in case DL pin is shorted to the LX pins, DL to LX\_ short-detection feature has been implemented. If the device detects that the DL pin is shorted to the LX pins before startup, the startup sequence is not be initiated and output voltage is not soft-started.

### Overcurrent Protection/Hiccup Mode

The device is provided with a robust overcurrent-protection scheme that protects the device under overload and output short-circuit conditions. A cycle-by-cycle peak current limit turns off the high-side MOSFET whenever the high-side switch current exceeds an internal limit. A runaway-current limit on the high-side switch current protects the device under high input voltage, short-circuit conditions when there is insufficient output voltage available to restore the inductor current that was built up during the on-period of the step-down converter.

One occurrence of the runaway-current limit triggers a hiccup mode. In addition, if due to a fault condition, output voltage drops to 68% (typ) of its nominal value any time after soft-start is complete, hiccup mode is triggered.

The device has two modes of operation under overload conditions – hiccup mode and latching mode. In hiccup mode, the converter is protected by suspending switching for a hiccup timeout period of 32,768 clock cycles. Once the hiccup-timeout period expires, soft-start is attempted again. In latching mode, the converter does not attempt to soft-start the output after a timeout period. The power supply to the device needs to be cycled to turn the part on again in latching mode of operation. A resistor connected from DL to SGND sets the peak and runaway current limits and the operating mode during overload conditions.

### RESET Output

RESISTANCE (kΩ)	PEAK CURRENT LIMIT (A)	RUNAWAY CURRENT LIMIT (A)	FAULT OPERATING MODE
Open	6.5	7.5	Hiccup
174	6.5	7.5	Latching
61.9	5	6	Hiccup
26.1	5	6	Latching

The device includes a  $\overline{\text{RESET}}$  comparator to monitor the status of the output voltage. The open-drain  $\overline{\text{RESET}}$  output requires an external pullup resistor.  $\overline{\text{RESET}}$  goes high (high impedance) 1024 switching cycles after the regulator output increases above 95.6% of the designed nominal regulated voltage.  $\overline{\text{RESET}}$  goes low when the regulator output voltage drops to below 92.2% of the set nominal output regulated voltage.  $\overline{\text{RESET}}$  also goes low during thermal shutdown.

### Prebiased Output

When the device starts into a prebiased output, both the high-side and the low-side switches are turned off so the converter does not sink current from the output. High-side and low-side switches do not start switching until the PWM comparator commands the first PWM pulse, at which point switching commences. The output voltage is then smoothly ramped up to the target value in alignment with the internal reference.

### Thermal Shutdown Protection

Thermal-shutdown protection limits total power dissipation in the MAX17536. When the junction temperature of the device exceeds +165°C, an on-chip thermal sensor shuts down the device, allowing it to cool. The MAX17536 turns

ON with soft-start after the junction temperature reduces by 10°C. Carefully evaluate the total power dissipation (see the [Power Dissipation](#) section) to avoid unwanted triggering of the thermal shutdown in normal operation.

## Applications Information

### Input Capacitor Selection

The input-filter capacitor reduces peak currents drawn from the power source and reduces noise and voltage ripple on the input caused by the circuit's switching. The input capacitor RMS current requirement ( $I_{\text{RMS}}$ ) is defined by the following equation:

$$I_{\text{RMS}} = I_{\text{OUT(MAX)}} \times \frac{\sqrt{V_{\text{OUT}} \times (V_{\text{IN}} - V_{\text{OUT}})}}{V_{\text{IN}}}$$

where,  $I_{\text{OUT(MAX)}}$  is the maximum load current.  $I_{\text{RMS}}$  has a maximum value when the input voltage equals twice the output voltage ( $V_{\text{IN}} = 2 \times V_{\text{OUT}}$ ), so  $I_{\text{RMS(MAX)}} = I_{\text{OUT(MAX)}/2$ .

Choose an input capacitor that exhibits less than +10°C temperature rise at the RMS input current for optimal long-term reliability. Use low-ESR ceramic capacitors with high ripple-current capability at the input. X7R capacitors are recommended in industrial applications for their temperature stability. Calculate the input capacitance using the following equation:

$$C_{\text{IN}} = \frac{I_{\text{OUT(MAX)}} \times D \times (1-D)}{\eta \times f_{\text{SW}} \times \Delta V_{\text{IN}}}$$

where  $D = V_{\text{OUT}}/V_{\text{IN}}$  is the duty ratio of the converter,  $f_{\text{SW}}$  is the switching frequency,  $\Delta V_{\text{IN}}$  is the allowable input voltage ripple, and  $\eta$  is the efficiency.

In applications where the source is located distant from the device input, an electrolytic capacitor should be added in parallel to the ceramic capacitor to provide necessary damping for potential oscillations caused by the inductance of the longer input power path and input ceramic capacitor.

### Inductor Selection

Three key inductor parameters must be specified for operation with the MAX17536: inductance value (L), inductor saturation current ( $I_{\text{SAT}}$ ), and DC resistance ( $R_{\text{DCR}}$ ). The switching frequency and output voltage determine the inductor value as follows:

$$L = \frac{V_{\text{OUT}}}{2.2 \times f_{\text{SW}}}$$

where  $V_{\text{OUT}}$  and  $f_{\text{SW}}$  are nominal values.

Select a low-loss inductor closest to the calculated value with acceptable dimensions and having the lowest possible DC resistance. The saturation current rating ( $I_{SAT}$ ) of the inductor must be high enough to ensure that saturation can occur only above the peak current-limit value.

### Output Capacitor Selection

X7R ceramic output capacitors are preferred due to their stability over temperature in industrial applications. The output capacitors are usually sized to support a step load of 50% of the maximum output current in the application, so the output-voltage deviation is contained to 3% of the output-voltage change. The minimum required output capacitance can be calculated as follows:

$$C_{OUT} = \frac{1}{2} \times \frac{I_{STEP} \times t_{RESPONSE}}{\Delta V_{OUT}}$$

$$t_{RESPONSE} \cong \left( \frac{0.33}{f_C} + \frac{1}{f_{SW}} \right)$$

where  $I_{STEP}$  is the load current step,  $t_{RESPONSE}$  is the response time of the controller,  $\Delta V_{OUT}$  is the allowable output-voltage deviation,  $f_C$  is the target closed-loop crossover frequency, and  $f_{SW}$  is the switching frequency. Select  $f_C$  to be 1/9th of  $f_{SW}$  if the switching frequency is less than or equal to 450kHz. If the switching frequency is greater than 450kHz, select  $f_C$  to be 50kHz.

### Soft-Start Capacitor Selection

The MAX17536 implements adjustable soft-start operation to reduce inrush current. A capacitor connected from the SS pin to SGND programs the soft-start time. The selected output capacitance ( $C_{SEL}$ ) and the output voltage ( $V_{OUT}$ ) determine the minimum required soft-start capacitor as follows:

$$C_{SS} \geq 28 \times 10^{-6} \times C_{SEL} \times V_{OUT}$$

The soft-start time ( $t_{SS}$ ) is related to the capacitor connected at SS ( $C_{SS}$ ) by the following equation:

$$t_{SS} = C_{SS} / (5.55 \times 10^{-6})$$

For example, to program a 4ms soft-start time, a 22nF capacitor should be connected from the SS pin to SGND.

### Setting the Input Undervoltage-Lockout Level

The MAX17536 offers an adjustable input undervoltage-lockout level. Set the voltage at which the device turns on with a resistive voltage-divider connected from  $V_{IN}$  to SGND (See [Figure 1](#)). Connect the center node of the divider to EN/UVLO.

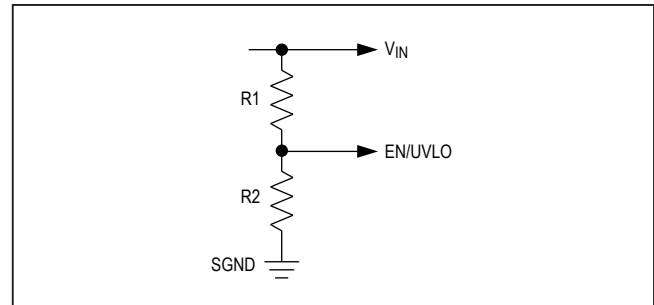

Figure 1. Setting the Input Undervoltage Lockout

Choose R1 to be 3.3M $\Omega$  and then calculate R2 as follows:

$$R2 = \frac{R1 \times 1.215}{(V_{INU} - 1.215)}$$

where  $V_{INU}$  is the voltage at which the device is required to turn on. Ensure that  $V_{INU}$  is higher than 0.8 x  $V_{OUT}$ .

### Loop Compensation

The MAX17536 is internally loop compensated. However, if the switching frequency is less than 450kHz, connect a 0402 capacitor ( $C12$ ) between the CF pin and the FB pin. Use [Table 2](#) to select the value of  $C12$ .

### Adjusting Output Voltage

Set the output voltage with a resistive voltage-divider connected from the positive terminal of the output capacitor ( $C_{OUT}$ ) to SGND (see [Figure 2](#)). Connect the center node of the divider to the FB pin. Use the following procedure to choose the resistive voltage-divider values:

Calculate resistor R3 from the output to FB as follows:

$$R3 = \frac{451 \times 10^3}{f_C \times C_{OUT\_SEL}}$$

where R3 is in k $\Omega$ , crossover frequency  $f_C$  is in kHz, and  $C_{OUT\_SEL}$  is Actual derated capacitance of selected output capacitor at DC-bias voltage in  $\mu$ F. Choose  $f_C$  to be 1/9th of the switching frequency ( $f_{SW}$ ) if the switching frequency is less than or equal to 450kHz. If the switching frequency is greater than 450kHz, select  $f_C$  to be 50kHz.

Calculate resistor R4 from FB to SGND as follows:

$$R4 = \frac{R3 \times 0.9}{(V_{OUT} - 0.9)}$$

**Table 2. C12 Capacitor Value at Various Switching Frequencies**

SWITCHING FREQUENCY RANGE (kHz)	C12 (pF)
200 to 300	2.2
300 to 450	1.2

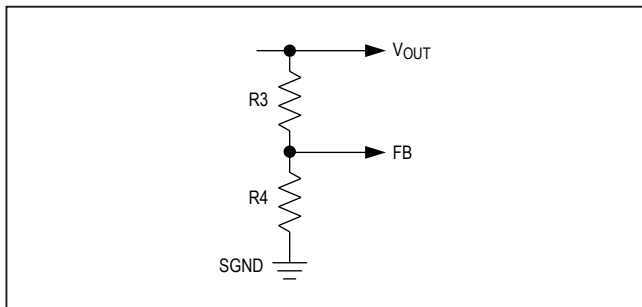

Figure 2. Setting the Output Voltage

### Power Dissipation

At a particular operating condition, the power losses that lead to temperature rise of the part are estimated as follows:

$$P_{\text{LOSS}} = \left( P_{\text{OUT}} \times \left( \frac{1}{\eta} - 1 \right) \right) - \left( I_{\text{OUT}}^2 \times R_{\text{DCR}} \right) - \left( I_{\text{OUT}}^2 \times (1-D) \times R_{\text{LS}} \right)$$

$$P_{\text{OUT}} = V_{\text{OUT}} \times I_{\text{OUT}}$$

where  $P_{\text{OUT}}$  is the total output power,  $\eta$  is the efficiency of the converter,  $R_{\text{DCR}}$  is the DC resistances of the inductor,  $R_{\text{LS}}$  is the on-resistance of the low-side external MOSFET, and  $D = V_{\text{OUT}}/V_{\text{IN}}$  is the duty ratio of the converter (see the [Typical Operating Characteristics](#) curves for more information on efficiency at typical operating conditions).

For the MAX17536 EV kit, the thermal-performance metrics for the package are given below:

$$\theta_{\text{JA}} = 23^{\circ}\text{C/W}$$

$$\theta_{\text{JC}} = 2^{\circ}\text{C/W}$$

The junction temperature of the device can be estimated at any given maximum ambient temperature ( $T_{\text{A\_MAX}}$ ) from the equation below:

$$T_{\text{J\_MAX}} = T_{\text{A\_MAX}} + (\theta_{\text{JA}} \times P_{\text{LOSS}})$$

If the application has a thermal-management system that ensures that the exposed pad of the device is maintained at a given temperature ( $T_{\text{EP\_MAX}}$ ) by using proper heat sinks, then the junction temperature of the device can be estimated at any given maximum ambient temperature from the equation below:

$$T_{\text{J\_MAX}} = T_{\text{EP\_MAX}} + (\theta_{\text{JC}} \times P_{\text{LOSS}})$$

Junction temperature greater than  $+125^{\circ}\text{C}$  degrades operating lifetimes.

### PCB Layout Guidelines

All connections carrying pulsed currents must be very short and as wide as possible. The inductance of these connections must be kept to an absolute minimum due to the high  $di/dt$  of the currents. Since inductance of a current-carrying loop is proportional to the area enclosed by the loop, if the loop area is made very small, inductance is reduced. Additionally, small current-loop areas reduce radiated EMI.

A ceramic input filter capacitor should be placed close to the  $V_{\text{IN}}$  pins of the IC. This eliminates as much trace inductance effects as possible and gives the IC a cleaner voltage supply. A bypass capacitor for the  $V_{\text{CC}}$  pin also should be placed close to the pin to reduce effects of trace impedance.

When routing the circuitry around the IC, the analog small-signal ground and the power ground for switching currents must be kept separate. They should be connected together at a point where switching activity is at a minimum, typically the return terminal of the  $V_{\text{CC}}$  bypass capacitor. This helps keep the analog ground quiet. The ground plane should be kept continuous/unbroken as long as possible. No trace carrying high switching current should be placed directly over any ground plane discontinuity.

PCB layout also affects the thermal performance of the design. A number of thermal vias that connect to a large ground plane should be provided under the exposed pad of the part for efficient heat dissipation.

For a sample layout that ensures first-pass success, refer to the MAX17536 evaluation kit layout available at [www.maximintegrated.com](http://www.maximintegrated.com).



# MAX17536

## 4.5V to 60V, 4A, High-Efficiency, Synchronous Step-Down DC-DC Converter with Internal Compensation



Figure 3. Typical Application Circuit for 5V Output

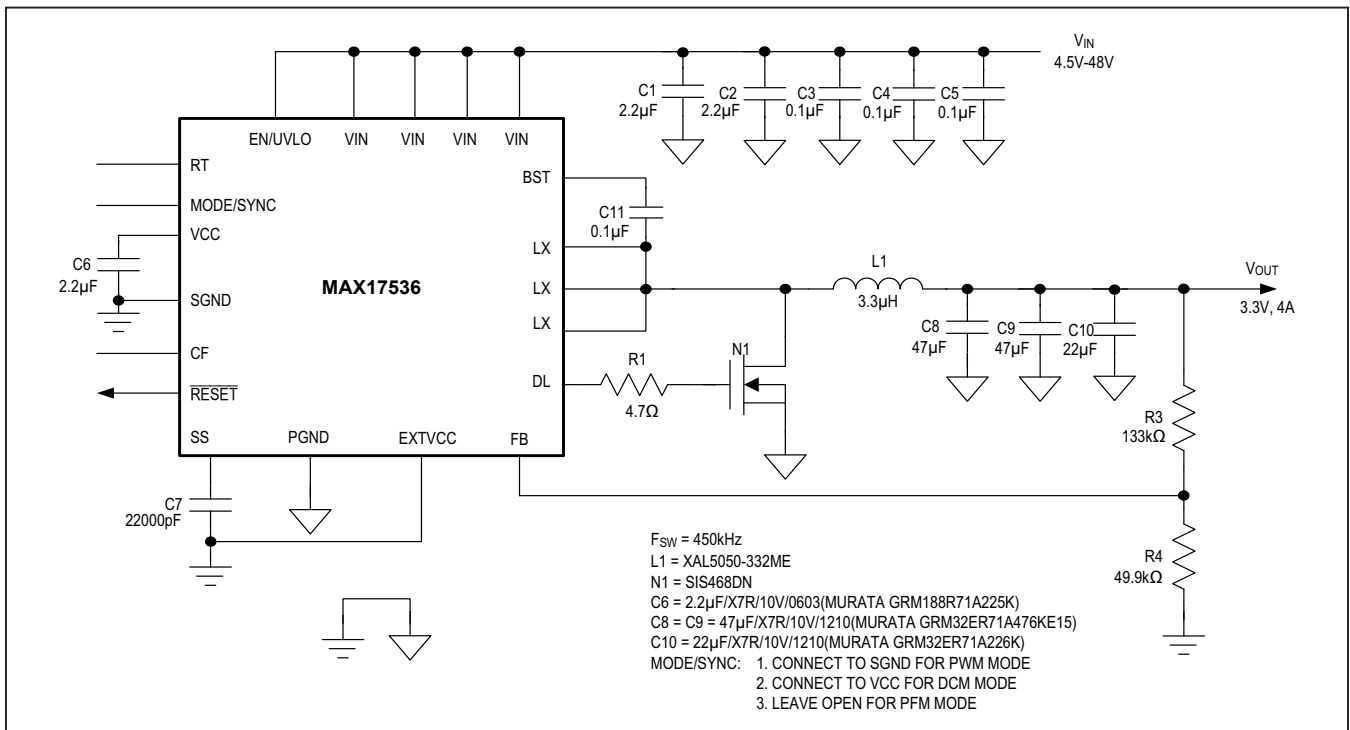

Figure 4. Typical Application Circuit for 3.3V Output

MAX17536

4.5V to 60V, 4A, High-Efficiency, Synchronous  
Step-Down DC-DC Converter  
with Internal Compensation

### Ordering Information

PART	PIN-PACKAGE
MAX17536ATP+	20 TQFN EP* 5mm x 5mm

**Note:** All devices operate over the temperature range of -40°C to +125°C, unless otherwise noted.

+Denotes a lead(Pb)-free/RoHS-compliant package.

\*EP = Exposed pad.

### Chip Information

PROCESS: BiCMOS

## Revision History

REVISION NUMBER	REVISION DATE	DESCRIPTION	PAGES CHANGED
0	6/15	Initial release	—
1	5/16	Updated Electrical Characteristics table and additional components in Bill of Materials	3, 11, 14, 17
2	6/18	Updated the <i>Benefits and Features</i> section, all <i>Typical Application Circuits</i> , <i>Absolute Maximum Ratings</i> , <i>Electrical Characteristics</i> , <i>Typical Operating Characteristics</i> , <i>Pin Description</i> , <i>Block Diagram</i> , <i>Detailed Description</i> , <i>DCM Mode Operation</i> , <i>Operating Input Voltage Range</i> , Table 1, <i>External Frequency Synchronization</i> , <i>RESET</i> <i>Output</i> , <i>Thermal Shutdown Protection</i> , <i>Input Capacitor Selection</i> , <i>Setting the Input Undervoltage-Lockout Level</i> , <i>Loop Compensation</i> , <i>Adjusting the Output Voltage</i> , Table 2, and <i>Power Dissipation</i>	1–17

For pricing, delivery, and ordering information, please visit Maxim Integrated's online storefront at <https://www.maximintegrated.com/en/storefront/storefront.html>.

Maxim cannot assume responsibility for use of any circuitry other than circuitry entirely embodied in a Maxim product. No circuit patent licenses are implied. Maxim reserves the right to change the circuitry and specifications without notice at any time. The parametric values (min and max limits) shown in the Electrical Characteristics table are guaranteed. Other parametric values quoted in this data sheet are provided for guidance.