

# Oval Red-Orange LED Lamp (3mm)

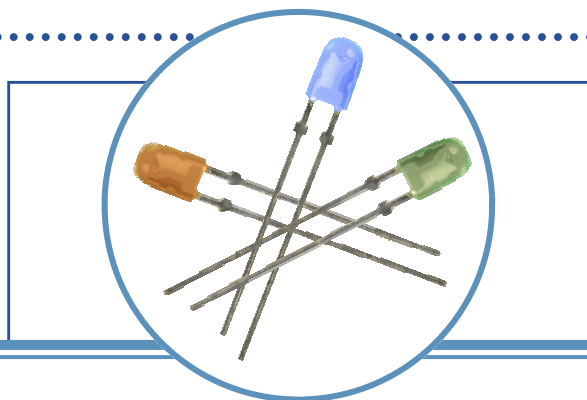

## OVLKQGT6

- High luminous intensity
- Defined spatial radiation
- Multiple viewing angles
- UV-resistant epoxy
- Precision optical performance



The OVLKQGT6 is designed for superior performance in outdoor environments. Its radiation pattern matches green (OVLKGGT6) and blue (OVLKBGT6) devices in identical packages to create LED pixels for full-color video screens.

### Applications

- Variable Message Signs
- Indoor/Outdoor Advertising Signage
- Traffic and Highway Signs
- Full-Color Video Signs

Part Number	Material	Emitted Color	Intensity Typ. mcd	Lens Color
OVLKQGT6	AllnGaP	Red-Orange	430	Orange Diffused

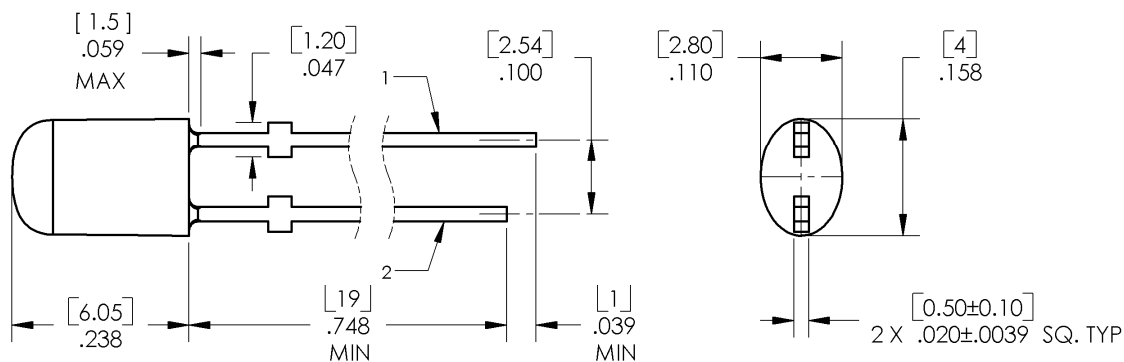

1 ANODE 2 CATHODE

DIMENSIONS ARE IN INCHES AND [MILLIMETERS].



Data is subject to change without prior notice.

# Oval Red-Orange LED Lamp (3mm)

## OVLKQGT6



### Absolute Maximum Ratings

T<sub>A</sub> = 25° C unless otherwise noted

Storage Temperature Range	-30 ~ +100 °C
Operating Temperature Range	-30 ~ +85 °C
Reverse Voltage	3 V
Continuous Forward Current	30 mA
Peak Forward Current (10% Duty Cycle, 1KHz)	100 mA
Power Dissipation	80 mW
Lead Soldering Temperature (5 seconds max)	260 °C

### Electrical Characteristics

T<sub>A</sub> = 25° C unless otherwise noted

SYMBOL	PARAMETER	MIN	TYP	MAX	UNITS	CONDITIONS
I <sub>V</sub>	Luminous Intensity	350	430	----	mcd	I <sub>F</sub> = 20 mA
V <sub>F</sub>	Forward Voltage	----	2.1	2.7	V	I <sub>F</sub> = 20 mA
I <sub>R</sub>	Reverse Current	----	----	50	μA	V <sub>R</sub> = 3V
λ <sub>D</sub>	Dominant Wavelength	611	616	621	nm	I <sub>F</sub> = 20 mA
2 Θ <sub>1/2</sub>	50% Power Angle	----	x: 100 y: 60	----	deg	I <sub>F</sub> = 20 mA

### Standard Bins (I<sub>F</sub> = 20mA)

Lamps are sorted to luminous intensity (I<sub>V</sub>) and dominant wavelength (λ<sub>D</sub>) bins shown. Orders for OVLKQGT6 may be filled with any or all bins contained as below.

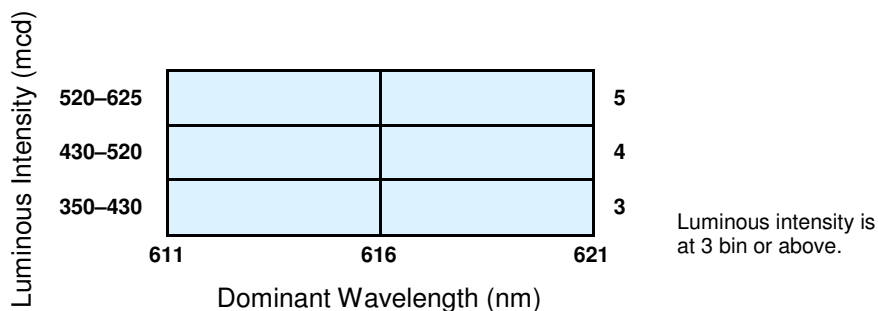

### Important Notes:

- All ranks will be included per delivery, rank ratio will be based on the chip distribution.
- To designate luminous intensity ranks, please contact OPTEK.
- When soldering, leave 2.5mm minimum clearance between the resin base and the soldering point.

# Oval Red-Orange LED Lamp (3mm) OVLKQGT6

## Typical Electro-Optical Characteristics Curves

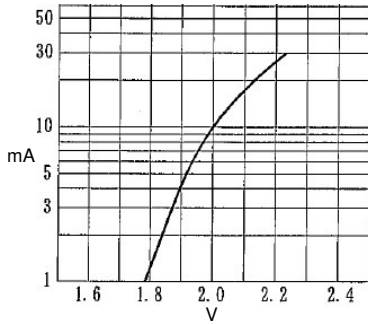

Forward Current vs. Forward Voltage

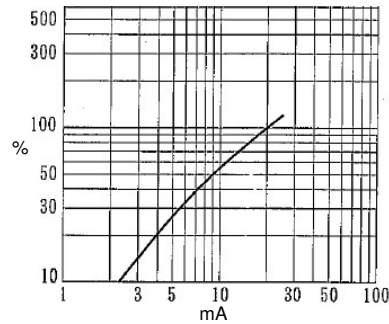

Relative Luminous Intensity vs. Forward Current

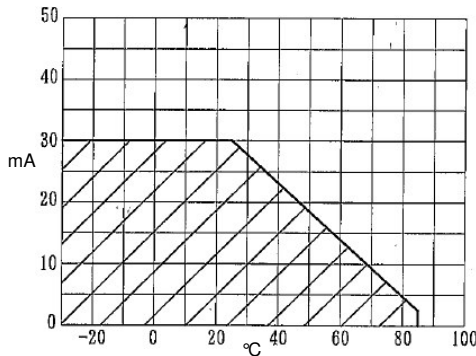

Maximum Forward DC Current vs. Ambient Temperature

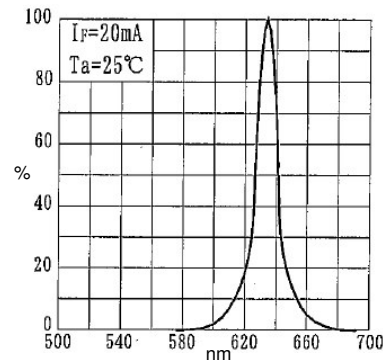

Relative Luminous Intensity vs. Wavelength

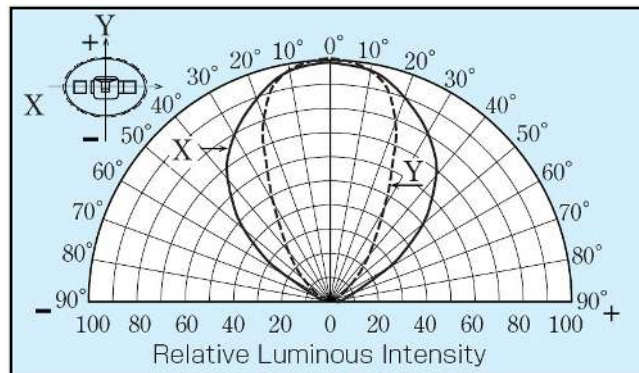

Oval Red-Orange LED Lamp (3mm)  
OVLKQGT6



Issue	Change Description	Approval	Date
1.0	Initial Release	J. Haynie	5/26/05