

## Features

- 28.5 dB Typical Gain
- 2.7 dB Typical Low Noise

## Description

M/A-COM's AM-182 is a high gain feedback amplifier with high intercept and compression points. This amplifier is packaged in a TO-8 package. Due to the internal power dissipation the thermal rise should be minimized. The ground plane on the PC board should be configured to remove heat from under the package. AM-182 is ideally suited for use where a high intercept, high reliability amplifier is required.

## Ordering Information

Part Number	Package
AM-182 PIN	TO-8-1
AMC-182 SMA	Connectorized

## TO-8-1

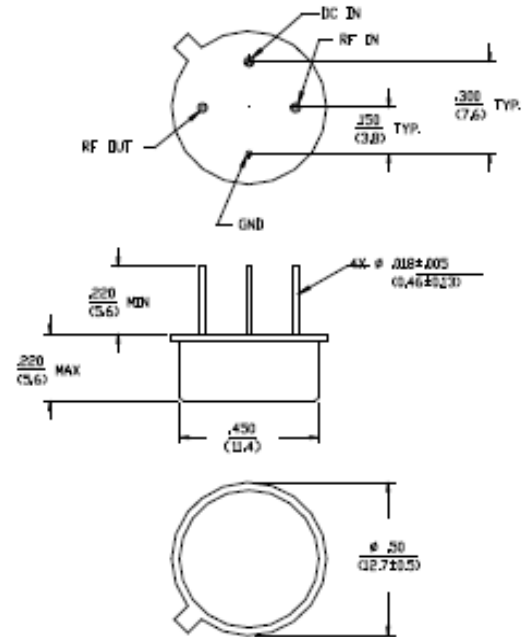

Dimensions in  $\phi$  are in mm  
 Unless Otherwise Noted, .XXX =  $\pm 0.010$  (.254)  
 .XX =  $\pm 0.02$  (.51)  
 WEIGHT (APPROX) (G) (OUNCES) 2.8 (0.10)

## Outline Drawing: SMA Connectorized \*

## Absolute Maximum Ratings <sup>1</sup>

Parameter	Absolute Maximum
Max. Input Power	+13 dBm
Vbias	+15.75 V
Operating Temperature	-55°C to +85°C
Storage Temperature	-65°C to +125°C

1. Operation of this device above any one of these parameters may cause permanent damage.

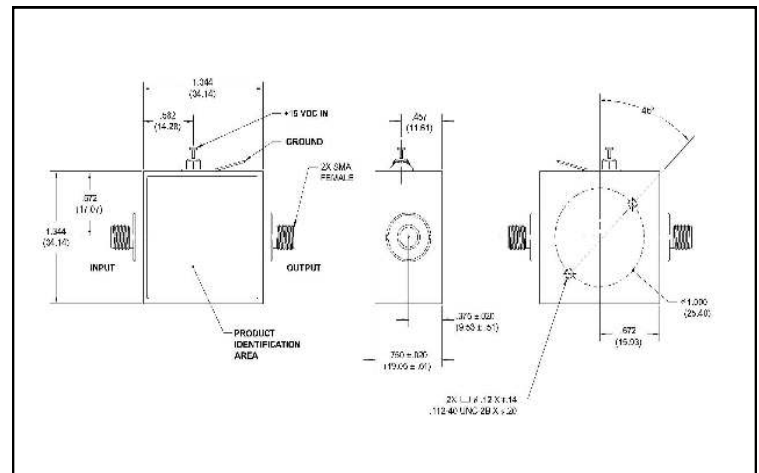

\* Dimensions are inches (millimeters)  $\pm 0.015$  (0.38) unless otherwise specified.

**Electrical Specifications: <sup>2,3</sup> T<sub>A</sub> = -55°C to +85°C Case Temperature**

Parameter	Test Conditions	Frequency	Units	Min.	Typ.	Max.
Gain	@+25°C	300 MHz	dB	27.2	28.2	29.2
Frequency Response	—	5 - 1000 MHz	dB	—	—	±1.2
Gain Variation with Temperature	—	5 - 1000 MHz	dB	—	—	±1.2
1 dB Compression	Output Power	5 - 1000 MHz	dBm	+9	—	—
Noise Figure	—	5 - 1000 MHz	dB	—	—	4.5
Reverse Transmission	—	5 - 1000 MHz	dB	—	-36	-32
VSWR	—	5 - 1000 MHz	Ratio	—	—	2.0:1
Output IP <sub>2</sub>	Two-Tone inputs up to 0 dBm	5 - 1000 MHz	dBm	+28	—	—
Output IP <sub>3</sub>	Two-Tone inputs up to 0 dBm	5 - 1000 MHz	dBm	+18	—	—
Vbias	—	—	VDC	+14.5	+15.0	+15.5
Ibias	Vbias = +15.0 VDC	—	mA	—	44	50
Power Dissipation	@ +15 V Bias	—	mW	—	660	—

2. All specifications apply when operated at +15 VDC, with 50 ohms source and load impedance.

3. Heat Sinking: Operation at case temperature above 95°C is not recommended. Heat sinking adequate to dissipate 800 mW must be provided in use.

## Typical Performance Curves

**Gain vs. Frequency**

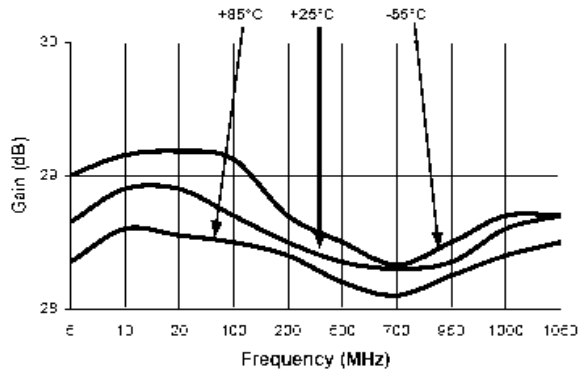

**VSWR vs. Frequency**

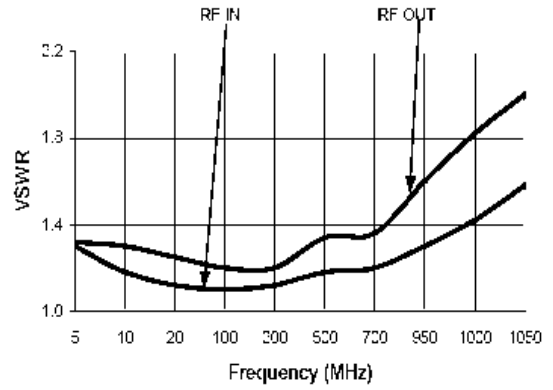

**Noise Figure**

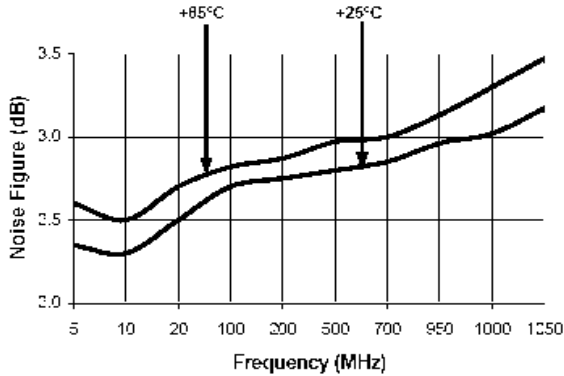

**1 dB Compression**

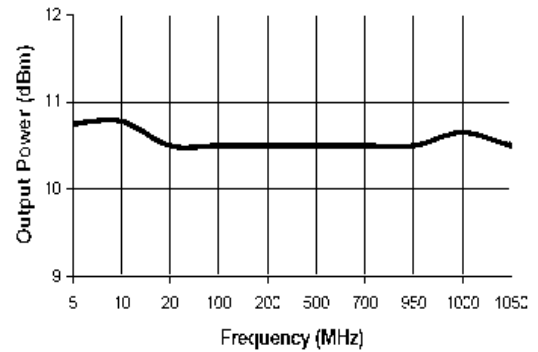

**Intermodulation Intercept**

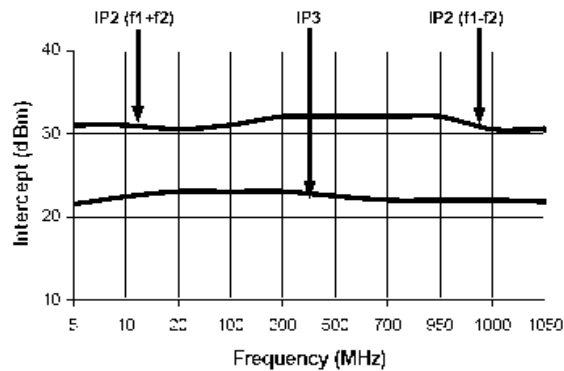

M/A-COM Technology Solutions Inc. All rights reserved.

Information in this document is provided in connection with M/A-COM Technology Solutions Inc ("MACOM") products. These materials are provided by MACOM as a service to its customers and may be used for informational purposes only. Except as provided in MACOM's Terms and Conditions of Sale for such products or in any separate agreement related to this document, MACOM assumes no liability whatsoever. MACOM assumes no responsibility for errors or omissions in these materials. MACOM may make changes to specifications and product descriptions at any time, without notice. MACOM makes no commitment to update the information and shall have no responsibility whatsoever for conflicts or incompatibilities arising from future changes to its specifications and product descriptions. No license, express or implied, by estoppels or otherwise, to any intellectual property rights is granted by this document.

THESE MATERIALS ARE PROVIDED "AS IS" WITHOUT WARRANTY OF ANY KIND, EITHER EXPRESS OR IMPLIED, RELATING TO SALE AND/OR USE OF MACOM PRODUCTS INCLUDING LIABILITY OR WARRANTIES RELATING TO FITNESS FOR A PARTICULAR PURPOSE, CONSEQUENTIAL OR INCIDENTAL DAMAGES, MERCHANTABILITY, OR INFRINGEMENT OF ANY PATENT, COPYRIGHT OR OTHER INTELLECTUAL PROPERTY RIGHT. MACOM FURTHER DOES NOT WARRANT THE ACCURACY OR COMPLETENESS OF THE INFORMATION, TEXT, GRAPHICS OR OTHER ITEMS CONTAINED WITHIN THESE MATERIALS. MACOM SHALL NOT BE LIABLE FOR ANY SPECIAL, INDIRECT, INCIDENTAL, OR CONSEQUENTIAL DAMAGES, INCLUDING WITHOUT LIMITATION, LOST REVENUES OR LOST PROFITS, WHICH MAY RESULT FROM THE USE OF THESE MATERIALS.

MACOM products are not intended for use in medical, lifesaving or life sustaining applications. MACOM customers using or selling MACOM products for use in such applications do so at their own risk and agree to fully indemnify MACOM for any damages resulting from such improper use or sale.