

# MAXIM

## -48V to +5V Output Switching DC-DC Converter

MAX650

### General Description

The MAX650 is a low-power fixed +5V output switching DC-DC converter designed for operation from very high negative input voltages. All control functions and a 120V, 250mA PNP transistor are contained in this device, reducing external components. A soft-start eliminates overshoot on turn on, and a Shutdown pin (SHDN) allows the output to be turned on and off. In addition, peak current limiting is provided on the PNP output.

The MAX650 features user-controllable operating frequency and a separate low voltage detector with adjustable hysteresis for monitoring the supply voltage. It can be set to trip at any negative voltage with a simple voltage divider.

The MAX650 is available in an A version with  $\pm 5\%$  output voltage tolerance and a B version with  $\pm 10\%$  tolerance.

### Applications

Telephone (-48V) Powered Devices  
Negative Input to +5V Converter

### Pin Configurations

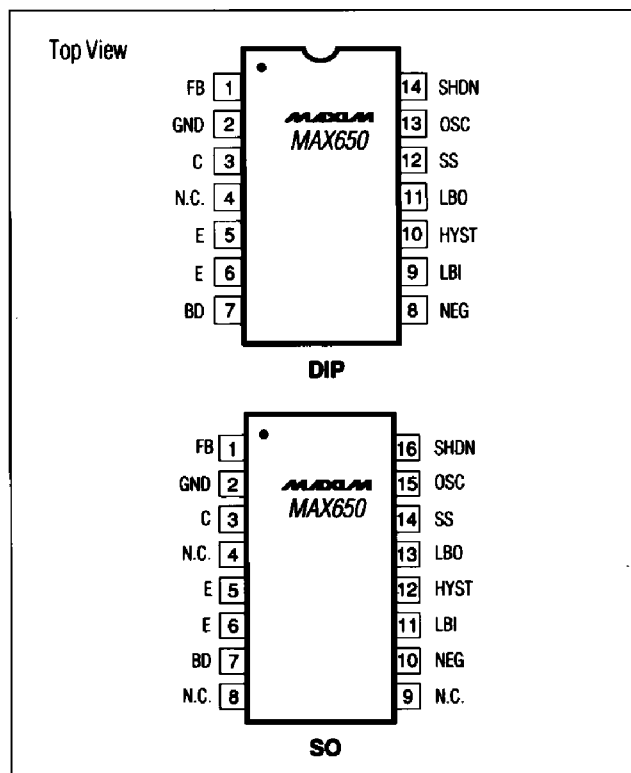

### Features

- ◆ +5V at 250mA From a -48V Source
- ◆ Selectable Soft-Start Function
- ◆ Shutdown Pin for Output On-Off Control
- ◆ Internal 120V, 250mA Switching PNP Transistor
- ◆ Low Component Count
- ◆ Low Battery Voltage Detector

### Ordering Information

PART	TEMP. RANGE	PIN-PACKAGE
MAX650ACPD	0°C to +70°C	14 Plastic DIP
MAX650ACWE	0°C to +70°C	16 Wide SO
MAX650AC/D	0°C to +70°C	Dice
MAX650BCPD	0°C to +70°C	14 Plastic DIP
MAX650BCWE	0°C to +70°C	16 Wide SO
MAX650BC/D	0°C to +70°C	Dice
MAX650AEPD	-40°C to +85°C	14 Plastic DIP
MAX650AEWE	-40°C to +85°C	16 Wide SO
MAX650BEPD	-40°C to +85°C	14 Plastic DIP
MAX650BEWE	-40°C to +85°C	16 Wide SO
MAX650AMJD	-55°C to +125°C	14 Ceramic DIP
MAX650BMJD	-55°C to +125°C	14 Ceramic DIP

### Typical Operating Circuit

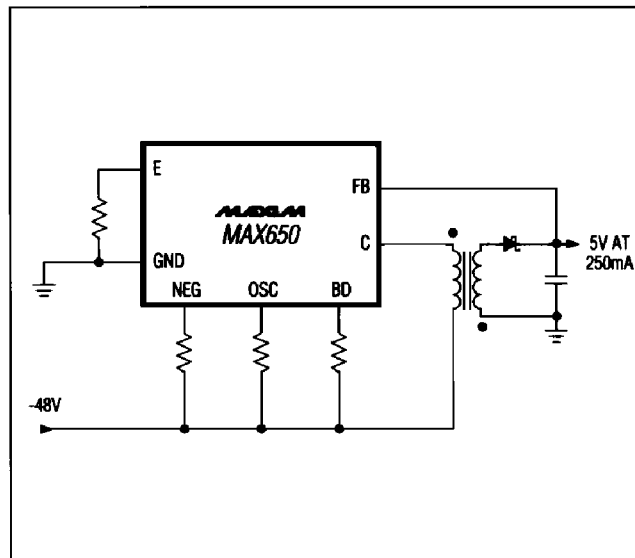

MAXIM

Maxim Integrated Products 1

For free samples & the latest literature: <http://www.maxim-ic.com>, or phone 1-800-998-8800.  
For small orders, phone 1-800-835-8769.

# -48V to +5V Output Switching DC-DC Converter

## ABSOLUTE MAXIMUM RATINGS

(Unless otherwise noted, all voltages are referenced to the GND terminal.)

Collector (C) Current, $I_C$ .....	-300mA	HYST Source Current, $I_{HYST}$ .....	$\pm 10$ mA
Collector (C) Voltage, $V_C$ .....	-120V	Power Dissipation	
Emitter (E) Voltage, $V_E$ .....	-1V to +0.3V	Plastic DIP (derate 6.5mW/°C above 25°C) .....	470mW
Base BD Current, $I_{BD}$ .....	-50mA	Small Outline (derate 10mW/°C above 75°C) .....	750mW
FB Voltage, $V_{FB}$ .....	+7V	CERDIP (derate 11mW/°C above 75°C) .....	825mW
LBI, SS and SHDN Currents .....	$\pm 10$ mA	Operating Temperature	
LBO Voltage, $V_{LBO}$ .....	( $V_{NEG} - 0.3$ ) to ( $V_{NEG} + 15$ ) V	MAX650C_ .....	0°C to +70°C
Voltage at OSC, BD, HYST, LBI, SS, and SHDN .....	( $V_{NEG} - 0.3$ ) to 0V	MAX650E_ .....	-40°C to +85°C
NEG Current, $I_{NEG}$ .....	-25mA	MAX650M_ .....	-55°C to +125°C
OSC Current, $I_{OSC}$ .....	$\pm 10$ mA	Storage Temperature .....	-65°C to +160°C
LBO Sink Current, $I_{LBO}$ .....	-10mA	Lead Temperature (Soldering, 10 sec.) .....	+300°C

Stresses beyond those listed under "Absolute Maximum Ratings" may cause permanent damage to the device. These are stress ratings only, and functional operation of the device at these or any other conditions beyond those indicated in the operational sections of the specifications is not implied. Exposure to absolute maximum rating conditions for extended periods may affect device reliability.

## ELECTRICAL CHARACTERISTICS

(GND = 0V,  $T_A = +25^\circ\text{C}$ , unless otherwise noted. MIN and MAX values are based on magnitude without regard to sign.)

PARAMETER	SYMBOL	CONDITIONS	MIN	TYP	MAX	UNITS
Output (load) Voltage	$V_{FB}$	$T_A = \text{Full}$ MAX650A MAX650B	+4.75 +4.5	+5 +5	+5.25 +5.5	V
Feedback Input Current	$I_{FB}$	$V_{FB} = +5\text{V}$		40	100	$\mu\text{A}$
Internal Zener Voltage	$V_{NEG}$	$T_A = \text{Full}$ , $I_{NEG} = -500\mu\text{A}$	-6	-7	-8	V
Internal Zener Current	$I_{NEG}$	$T_A = \text{Full}$	-0.3	-0.5	-10	mA
Current Sense Voltage	$V_E$		-140	-175	-210	mV
Peak Collector Current	$I_C$				-250	mA
Collector Leakage Current	$I_C$	$T_A = \text{Full}$ , $V_C = -120\text{V}$		0.1	10	mA
Collector (C) Saturation Voltage	$V_{SAT}$	$T_A = \text{Full}$ , $I_C = -250\text{mA}$ , $I_{BD} = -25\text{mA}$			-4	V
PNP Current Gain	$H_{FE}$	$T_A = \text{Full}$ , $V_C \leq -4\text{V}$ $I_C = -100\text{mA}$ $I_C = -250\text{mA}$	12 7	80 13		
Switching Frequency	$f_O$	$I_{OSC} = -12\mu\text{A}$ $T_A = +25^\circ\text{C}$ $T_A = \text{Full}$	17 15	20	23 25	kHz
Oscillator Input Voltage	$V_{OSC}$	$I_{OSC} = -12\mu\text{A}$		-2		V
Oscillator Input Current	$I_{OSC}$		-4	-12	-100	$\mu\text{A}$
Switching Duty Cycle	%ON	SS = Open Circuit SS = GND	44 20		56 30	%
Low Battery Input Threshold	$V_{LBI}$	$T_A = \text{Full}$	$V_{NEG} + 0.13$	$V_{NEG} + 0.08$	$V_{NEG} + 0.03$	V
Low Battery Input Current	$I_{LBI}$	$T_A = \text{Full}$		0.1	$\pm 100$	nA
Soft-Start Input Threshold	$V_{SS}$		-3	-4.5	-5	V
Soft-Start Input Current	$I_{SS}$				-10	$\mu\text{A}$
Shutdown Input Threshold	$V_{SHDN}$		-3	-4.5	-5	V
Shutdown Input Current	$I_{SHDN}$	$0\text{V} > V_{SHDN} > -3\text{V}$			-10	$\mu\text{A}$

# -48V to +5V Output Switching DC-DC Converter

## Pin Description

**MAX650**

PIN # 14-PIN DIP	PIN # 16-PIN Wide SO	NAME	FUNCTION
1	1	FB	Feedback Input. The 5V output is connected to FB, which regulates the output voltage. This input sinks approximately 40 $\mu$ A to VNEG.
2	2	GND	Ground. This is the positive side of the -48V input supply and the negative side of the +5V output. All specified voltages are referenced to this pin.
3	3	C	Output (collector) of the PNP transistor switch. Connect to the transformer primary. This pin can withstand up to -140V on the flyback cycle and sources up to 250mA from E, depending on the base drive current at BD.
4	4, 8, 9	N.C.	No Connection. These pins are open circuit.
5, 6	5, 6	E	Current sense input (emitter) of PNP transistor. Connect to GND, either directly or through a low-value sense resistor. When the voltage on these pins is more negative than -175mV, the PNP transistor is turned off for an entire cycle.
7	7	BD	Base Drive Input of PNP transistor. Figure 1.
8	10	NEG	Negative Power Connection. Anode of 7V Zener diode whose cathode is connected to GND. An external series limiting resistor is required between this pin and the -48V input supply. This resistor must also sink the LBO current (up to 100 $\mu$ A).

PIN # 14-PIN DIP	PIN # 16-PIN Wide SO	NAME	FUNCTION
9*	11*	LBI*	Low Battery Monitor Input. CMOS input.
10*	12*	HYST*	Low Battery Monitor Hysteresis Output. This P-channel FET sources up to 80 $\mu$ A to GND when the LBI input is 80mV more positive than VNEG; otherwise HYST is an open circuit.
11	13	LBO	Low Battery Monitor Output. Sinks up to 100 $\mu$ A to NEG when LBI is 80mV more positive than VNEG.
12*	14*	SS*	Soft-Start Input. Normally left open circuit for 50% duty cycle. Connect to GND through a capacitor to change the oscillator duty cycle to 25% and reduce input current on startup.
13	15	OSC	Oscillator Frequency Control Input (Figure 2). The voltage on this pin is approximately -2V.
14	16	SHDN	Shutdown Input. Leave open circuit or connect to NEG for normal operation. Connect to GND through a 100k $\Omega$ resistor to stop oscillator and turn-off output.

\* Voltage limitations on HYST, LBI, and SS terminals.

HYST, LBI, and SS should not be connected to GND. This is because protection diodes associated with these terminals will be forward biased, interfering with correct operation. If low-voltage detection is not required, LBI must be connected to NEG, and the HYST terminal left open circuit. SS may be connected to GND through a 0.1 $\mu$ Fd, or smaller capacitor, to initiate soft-start on power up. If soft-start is not required, SS should also be connected to NEG.

### Operating Principle

The MAX650 is a flyback switching converter; energy from the input supply is first transferred to the transformer core through the primary winding, then discharged from the secondary winding into the load. A typical circuit consists of a battery in series with the primary coil of a transformer, a switch, a rectifier, and a filter. (Figure 3). During the first portion of the cycle, the switch is closed, and current builds up in the primary storing energy in the form of a magnetic field in the transformer's core.

During the second portion, or "flyback" part of the cycle, the switch opens, the magnetic field collapses, and the energy stored in the core is discharged through the secondary winding into the rectifier and the load. The switch is controlled by an oscillator whose output is gated

on and off by a comparator that monitors the output voltage. When the output voltage is below the comparator threshold (+5V) the switch turns on for the first half of the oscillator cycle. When the output voltage is above the comparator threshold, the switch skips an entire oscillator cycle. This "pulse-skipping" technique regulates by varying the average number of cycles over time rather than varying the duty cycle of the switch on each cycle.

Figure 4 shows the block diagram of the MAX650. PNP transistor, Q1, controls the input current to the transformer. The emitter of this transistor can be connected to GND directly or through a low-value current sense resistor. The collector of the transistor connects to the primary of the transformer. Transistor base drive is set by an external resistor connected to BD. The oscillator frequency is set by another external resistor at OSC.

# -48V to +5V Output Switching DC-DC Converter

A CMOS voltage comparator, for low battery or low input voltage detection, is included in the MAX650. Its input threshold voltage, LBI, is biased 80mV above the negative supply pin, NEG. The output, LBO, is an N-channel FET which sinks up to 100µA to NEG, and its drain can be connected to positive potentials above GND (up to 15V above VNEG).

## Circuit Details

A typical application circuit is shown in Figure 4. The basic operation is set by 4 external resistors, RNEG, ROSC, RBD, and RSENSE. Output current capability is determined by the transformer, as described later.

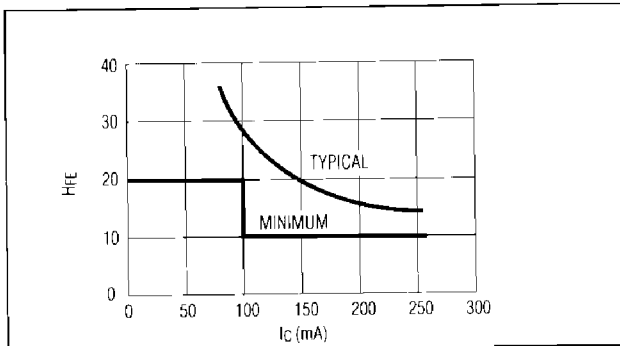

Figure 1.  $H_{FE}$  vs. Collector Current

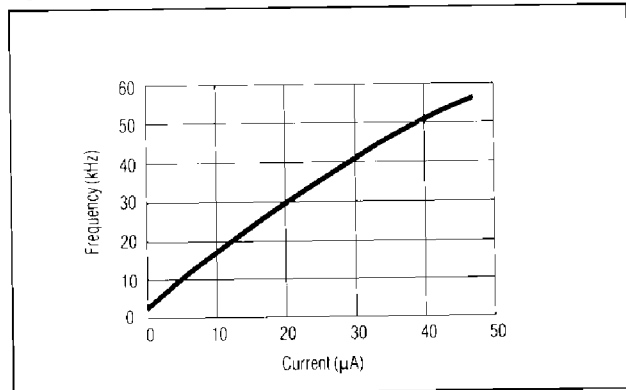

Figure 2. Oscillator Frequency vs. Oscillator Current

### Supply Current, RNEG

Although the MAX650 is meant to operate with high negative supply voltages ( $V_{INMIN}$  to  $V_{INMAX}$ ), it uses approximately -7V internally. This is set by an internal 7V zener diode connected between GND and NEG. The current through this diode must be more than 300µA and less than 10mA. It is set by the size of the external voltage dropping resistor, RNEG, and the supply voltage,  $V_{INMIN}$ .

$$[1] \quad R_{NEG} = (V_{INMIN} - V_{NEG}) / I_{NEG}$$

where,

$$[2] \quad I_{NEG} = 500\mu A + I_{LBO}$$

(Note that  $V_{INMIN}$ ,  $V_{NEG}$  and all currents are negative, but the calculations are simplified by using positive values.) If the low battery function is used, the LBO output sinks or furnishes load current,  $I_{LBO}$ , through the NEG pin, and this current must be added to the  $I_{NEG}$  current calculation as in Eq. 2.

Resistor, RNEG, should be calculated using the lowest supply voltage,  $V_{INMIN}$ , to insure an adequate  $I_{NEG}$  current.

Calculations for a typical application look like this:

$$V_{INMIN} = -36V; V_{INMAX} = -50V$$

$$LBO \text{ output current} = -100\mu A$$

The supply resistance is calculated for the lowest supply voltage and the highest current.

$$[2] \quad I_{NEG} = 500\mu A + I_{LBO} \\ = 500\mu A + 100\mu A = 600\mu A$$

$$[1] \quad R_{NEG} = (V_{INMIN} - V_{NEG}) / I_{NEG} \\ = (36V - 7V) / 600\mu A \\ = 48,333\Omega \text{ (use } 47k\Omega)$$

With the highest input voltage, the maximum current is:

$$[3] \quad I_{NEG} = (V_{INMAX} - V_{NEG}) / R_{NEG} \\ = (50V - 7V) / 47,000\Omega \\ = 915\mu A$$

### Oscillator Frequency, Rosc

The MAX650 varies its oscillator frequency in order to keep the energy delivered to the primary of the transformer constant with varying input voltages. The oscillator frequency is a nearly linear function of the current into the OSC pin. The frequency is set by resistor, ROSC, connected between OSC and the negative supply volt-

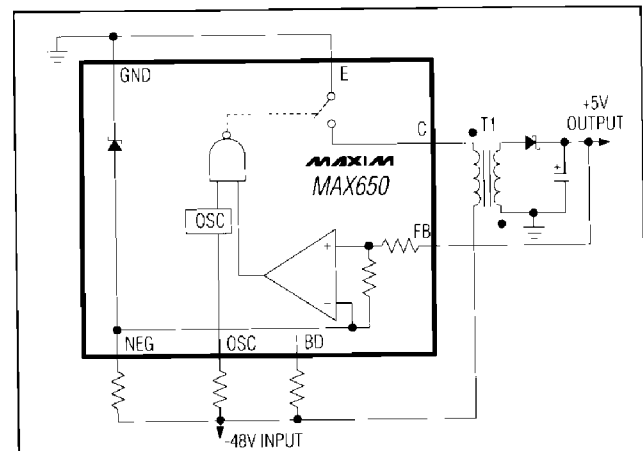

Figure 3. Typical Circuit

# -48V to +5V Output Switching DC-DC Converter

**MAX650**

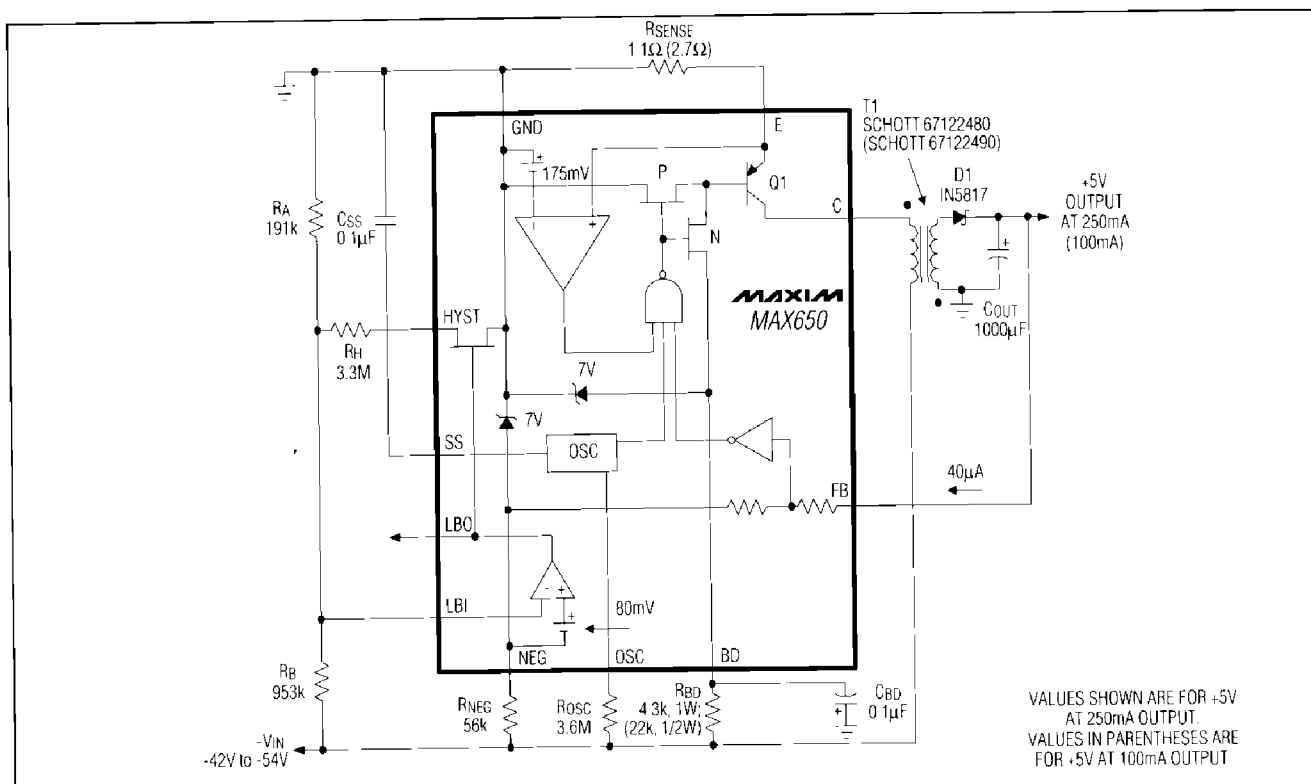

Figure 4. Typical Application Circuit

age. Therefore, the oscillator frequency is nearly proportional to the supply voltage, and the switch "on" period is inversely proportional to the supply voltage. The power stored in the primary is nearly constant with changes in supply voltage since the peak current through the switch and the primary of the transformer are proportional to the product of the "on" period of the switch and the input voltage.

Normally, the oscillator frequency is 20kHz when I<sub>OSC</sub> is -12µA, as shown in Figure 2. The value of R<sub>OSC</sub> is:

$$[4] \quad R_{OSC} = V_{INMIN} / I_{OSC}$$

### Soft-Start

The duty cycle of the output transistor is controlled by the SS pin which has a 1µA pull-down current to the NEG pin. When the SS pin is left open or connected to NEG, soft-start is disabled and the duty cycle of the switch is approximately 50%. When it is temporarily grounded through a 0.1µF capacitor, the switch is on for 25% of the time and off for 75%, until the capacitor is charged to V<sub>NEG</sub>. The MAX650 starts up slowly each time that power is applied and then switches over to normal operation. The soft-start circuit is shown in Figure 5. Note that the SS pin cannot be connected directly to GND.

### Current Sense, R<sub>SENSE</sub>

The Emitter, E, of the PNP transistor can be connected directly to GND. But, in order to protect the output transistor against destructive short-circuit currents, it should be connected to GND via a low-value current sense resistor, R<sub>SENSE</sub>. An internal comparator compares the voltage generated across the sense resistor at E to an internal -175mV reference and turns off the transistor

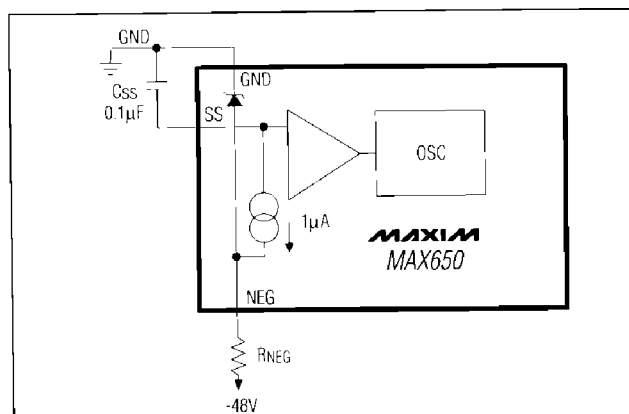

Figure 5. Soft-Start Circuit

## -48V to +5V Output Switching DC-DC Converter

when the peak current being switched exceeds this value. The value of  $R_{SENSE}$  is given by the formula:

$$[5] \quad R_{SENSE} = 175\text{mV} / I_{PEAK} \text{ (mA)}$$

Since the maximum current that the transistor can switch is 250mA, resistors less than  $0.70\Omega$  will afford no protection. For higher values,  $R_{SENSE}$  will limit the switch current to a safe level.

### Transformer

Transformer selection is governed by a number of factors. To simplify the process, Table 1 lists two transformers which have been tested with the MAX650.

The Transformer, T1, must store all of the energy that flows into the load. Accordingly, it should have a powdered iron or ferrite core, and it should have low resistance ( $10\Omega$  on the primary and  $0.2\Omega$  on the secondary) to minimize losses. Small toroids or pot cores are preferred.

The transformer design is based on four values: turns ratio, frequency and duty cycle, primary inductance, and peak current. The turns ratio is calculated by dividing the maximum supply voltage by the sum of the minimum output voltage ( $V_{FB}$ ) and the diode loss ( $V_F$ ) and multiplying the result by 0.75 for a safety factor.

$$[6] \text{ Turns Ratio} = \frac{0.75 \times V_{INMAX}}{(V_{FBMIN} + \text{diode } V_F)}$$

The design works backwards from the load as follows: the diode and transformer secondary resistance losses can be lumped together as "1V" so that the maximum secondary output voltage is 6.5V. Knowing the required output current,  $I_{OUT}$ , the Output Power,  $P_{OUT}$ , becomes:

$$[7] \quad P_{OUT} = 6.5\text{V} \times I_{OUT} \text{ (Watts)}$$

Assuming 95% efficiency in the transformer (transformer only, not the whole circuit), the input power to the primary,  $P_{IN}$  is:

$$P_{IN} = 6.5\text{V} \times I_{OUT} / 0.95 \text{ (Watts)}$$

$$[8] \quad P_{IN} = 6.84\text{V} \times I_{OUT} \text{ (Watts)}$$

With an oscillator frequency of 20kHz, the energy put into the coil,  $E_{IN}$ , during each "on" cycle is:

$$[9] \quad E_{IN} = P_{IN} / F_{OSC} \text{ (Joules)}$$

or:

$$[9A] \quad E_{IN} = 6.84\text{V} \times I_{OUT} / 20,000\text{Hz} \text{ (Joules)}$$

When the switch closes, the energy builds up in the primary inductance,  $L$ , to a maximum value. This energy can also be expressed as:

$$[10] \quad E_{IN} = (V_{INMIN} \times t_{ON})^2 / 2L \text{ (Joules)}$$

so that the primary inductance,  $L$ , is:

$$[11] \quad L = (V_{INMIN} \times t_{ON})^2 / 2 E_{IN} \text{ (Henries)}$$

Combining [9A] with [11], the primary inductance is:

$$[12] \quad L = \frac{(V_{INMIN} \times t_{ON})^2}{I_{OUT}} \text{ (Henries)}$$

At the end of the switch "on" period ( $t_{ON} = 25\mu\text{s}$  for a 20kHz 50% duty-cycle switch), the current rises to a peak value,  $I_{PEAK}$ .

$$[13] \quad I_{PEAK} = V_{INMIN} \times t_{ON} / L \text{ (Amperes)}$$

$I_{PEAK}$  must be less than 250mA to avoid exceeding the MAX650's collector current rating. When selecting the transformer, the transformer must have a peak primary current rating greater than  $I_{PEAK}$  to prevent core saturation.

In summary, set the oscillator frequency to 20kHz. The results of Equations 6, 12, and 13 determine the electrical characteristics of the transformer.

### Snubbers

When the power switch opens, the primary voltage will flyback to a high negative value which depends on the leakage inductance and capacitance of the transformer. This voltage could exceed the 140V peak voltage rating of the MAX650 collector and damage it if not limited by a series R-C network, or "snubber." The snubber network is usually placed in parallel with the transformer primary, and the R-C values depend on the transformer characteristics and must be determined experimentally.  $1000\Omega$  in series with 100pF is a good starting place. The snubber does dissipate some power, reducing the overall efficiency, but this can be minimized or eliminated by using a transformer with low leakage inductance.

Larger R and smaller C values improve efficiency, but may not adequately suppress the negative spike at C. Smaller R and larger C values reduce the size of the spike, but then reduce efficiency. The optimum snubber balances these two goals.

Under ideal conditions, the snubber may be omitted. If either of the two transformers shown in Table 1 is used, the snubber is not needed.

### Base Drive, $R_{BO}$

The output transistor, Q1, is turned on by a combination of the oscillator "on" pulse: the output voltage comparator output high, the sense comparator high, and the base drive current. The output transistor is turned off by a P-channel FET that shorts its base to GND.

In order to conserve power, the base drive current to the switching PNP transistor is set by adjusting current through the base drive pin, BD.  $I_{BD}$  is set to a value that insures that Q1 nearly saturates when it is turned on,

# -48V to +5V Output Switching DC-DC Converter

based on the minimum beta for the output current. For example:

$$[14] \quad I_{BD} = I_{PEAK} / H_{FE}$$

The  $H_{FE}$  vs. collector current is shown in Figure 1.

The base drive circuit includes a shunt zener that clamps the base drive voltage to  $V_{NEG}$  during the off period. Thus, for half of the cycle the current through BD is wasted. This loss can be recovered, however, if a 0.1 $\mu$ F capacitor is placed between BD and GND. This capacitor effectively captures the lost current and makes it available for the whole cycle. More importantly, it effectively halves the required base drive current so that the base resistor is:

$$[15] \quad R_{BD} = 2 \times (V_{INMIN} - 7V) / I_{BD}$$

Note that with high current designs,  $R_{BD}$  may need to dissipate up to 600mW.

### Capacitors

The output capacitor should be at least 10 $\mu$ F, increasing approximately 1 $\mu$ F/mA of output current. Low ESR capacitors, such as tantalums, are preferred. But, if aluminum electrolytics are used, each should be paralleled with a 0.1 $\mu$ F disk ceramic. Because of possible switching transients, 0.1 $\mu$ F should also be connected between NEG and GND.

### Diodes

Schottky diodes are preferred for the secondary rectifier. Their low forward voltage drop and fast switching times make them the best choice for efficiency. The 1N5817 is a good example.

### Low Battery Monitor

A low battery monitor with adjustable hysteresis is built into the MAX650. When LBI is connected to NEG (approximately -7V), LBO sinks up to -100 $\mu$ A to NEG, and the HYST pin, a P-channel FET drain, sources up to 100 $\mu$ A to GND. When LBI is connected to a voltage more positive than -7V, LBO and HYST outputs are open circuits. Normally LBI is connected to the negative supply via a voltage divider to GND, and a hysteresis resistor,  $R_H$ , is connected between HYST and LBI. The resistors are shown in Figure 6 and are calculated by the following formulas:

$$[16] \quad R_B = 20 \times (V_{INMAX} - 7V) \text{ (k}\Omega\text{)}$$

$$[17] \quad R_A = \frac{7V \times R_B}{V_{TL} - 7V}$$

Where  $V_{TL}$  is the low threshold voltage input, and  $V_{INMAX}$  is the maximum power-supply voltage. Both are positive in these calculations.

When hysteresis is used, the value of  $R_H$ , which would otherwise be open circuit, is determined by:

$$[18] \quad R_H = \frac{R_A \times R_B \times 7V}{R_A \times (V_{TH} - 7V) - (7V \times R_B)} \text{ (k}\Omega\text{)}$$

or:

$$[18A] \quad R_H = \frac{V_{TL}}{(V_{TH} - V_{TL})} \times \frac{R_A \times R_B}{R_A + R_B} \text{ (k}\Omega\text{)}$$

Where  $V_{TL}$  is the lower threshold voltage, and  $V_{TH}$  is the higher threshold voltage (again using positive values). The hysteresis is the difference between  $V_{TH}$  and  $V_{TL}$ .

Since the voltage at NEG has a range of -6V to -8V (over temperature) LBI and, thus, the higher and lower threshold voltages, cannot be set to better than  $\pm 16\%$ .

### Voltage Limitations at HYST, LBI, and SS

These three terminals may not be connected directly to GND. Connection to GND forward biases diodes associated with these terminals and interferes with the correct operation of the device. If the low voltage monitor is not

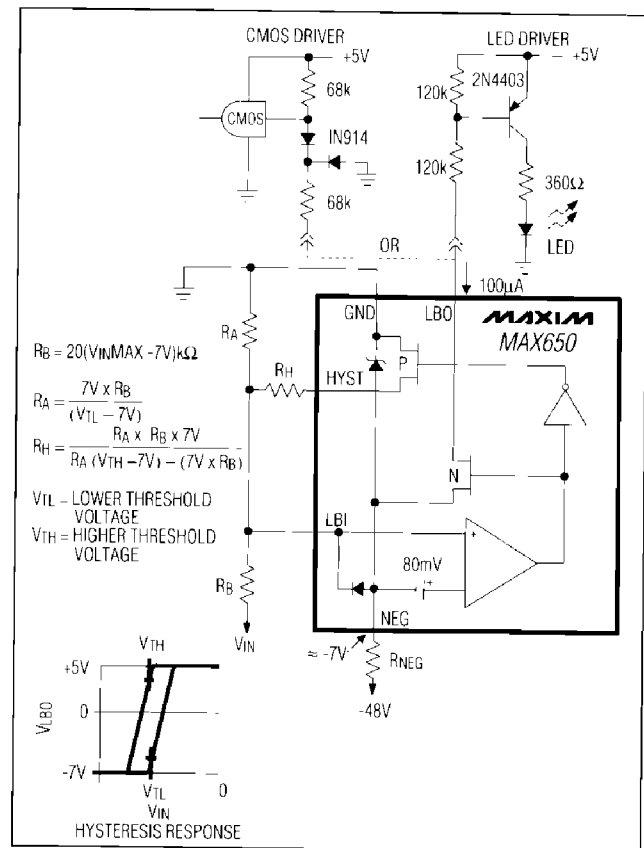

Figure 6. Low Battery Detector Circuit

## -48V to +5V Output Switching DC-DC Converter

required, LBI should be connected to NEG and HYST left open circuit. SS may be connected to GND through a capacitor to initiate soft start on power-up. If the soft-start function is not required, SS must be connected to NEG.

### Shutdown

The SHDN trip voltage is typically -4.5V. If the function is not required, SHDN may be left open circuit or connected to NEG. The terminal has a 1 $\mu$ A pulldown current to NEG. To activate SHDN, this terminal may be raised positively above -4.5V and connected to GND or to a positive voltage of up to +15V with respect to NEG.

### A Design Example

Figure 4 shows a complete circuit with all values. Table 1 lists the transformers that may be used to produce +5V at 250mA or 100mA. These values are derived from the following procedure, which may be adjusted for any input voltage range and output current:

$$\begin{aligned} V_{INMIN} &= -42V \\ V_{INMAX} &= -54V \\ \text{Output} &= +5V \text{ at } 250\text{mA} \end{aligned}$$

$$\begin{aligned} V_{TL} &= -42V \text{ (the low threshold)} \\ V_{TH} &= -44V \text{ (the high threshold)} \\ I_{LBO} &= 100\mu\text{A} \end{aligned}$$

First, set the oscillator to 20kHz with the lowest input voltage. From Figure 2,  $I_{OSC} = 12\mu\text{A}$  and  $R_{OSC}$  is:

$$\begin{aligned} [4] \quad R_{OSC} &= V_{INMIN} / I_{OSC} \\ &= 42V / 12\mu\text{A} \\ &= 3.5\text{M}\Omega, \text{ use } 3.6\text{M}\Omega \end{aligned}$$

Next, from Formula [1], calculate  $R_{NEG}$ .

$$\begin{aligned} [1] \quad R_{NEG} &= (V_{INMIN} - V_{NEG}) / I_{NEG} \\ &= (42V - 7V) / (500\mu\text{A} + 100\mu\text{A}) \\ &= 58.33\text{k}\Omega, \text{ use } 56\text{k}\Omega \end{aligned}$$

The transformer: calculate the primary inductance using the minimum supply voltage.

$$[12] \quad L = \frac{(V_{INMIN} \times t_{ON})^2 \times 1462}{I_{OUT}}$$

or,

$$\begin{aligned} L &= \frac{42 \times 42 \times 25 \times 10^{-12} \times 1462}{0.25} \\ L &= 6447\mu\text{H} = 6.5\text{mH} \end{aligned}$$

The turns ratio should be calculated using the maximum supply voltage and the minimum output voltage, including the diode loss.

$$\begin{aligned} [6] \quad \text{Turns Ratio} &= \frac{0.75 \times V_{INMAX}}{(V_{FBMIN} + \text{diode } V_F)} \\ &= 0.75 \times 54 / (4.5 + .4) = 40.5 / 4.9 \\ \text{Turns Ratio} &= 8.27, \text{ use } 8 \end{aligned}$$

Calculate the peak current in the primary and the transistor using the minimum input voltage again.

$$\begin{aligned} [13] \quad I_{PEAK} &= V_{INMIN} \times t_{ON} / L \\ &= 42 \times 25 \times 10^{-6} / (6500 \times 10^{-6}) \\ &= 162\text{mA} \end{aligned}$$

From Figure 1, when  $I_C = 162\text{mA}$  and  $H_{FE} = 10$ , and from Formula 14:

$$\begin{aligned} [14] \quad I_{BD} &= I_{PEAK} / H_{FE} \\ &= .162 / 10 = 0.0162\text{A} \end{aligned}$$

Calculate the Base Drive Resistor,  $R_{BD}$ , from Formula 15 using  $V_{INMIN} = 42\text{V}$ .

$$\begin{aligned} [15] \quad R_{BD} &= 2 \times (V_{INMIN} - 7V) / I_{BD} \\ &= 2 \times (42V - 7V) / 0.0162\text{A} \\ &= 4321\Omega, \text{ use } 4.3\text{k}\Omega \end{aligned}$$

Note that with the maximum supply voltage, the power dissipated by  $R_{BD}$  is:

$$\begin{aligned} P_{BD} &= V_{BD}^2 / R_{BD} \\ &= (54 - 7)^2 / 4300 \\ &= 0.52\text{W} \end{aligned}$$

Next, calculate value of  $R_{SENSE}$ .

$$\begin{aligned} [5] \quad R_{SENSE} &= 175(\text{mV}) / I_{PEAK}(\text{mA}) \\ &= .175V / .162\text{A} \\ &= 1.08\Omega, \text{ use } 1.1\Omega \end{aligned}$$

Last, calculate the LBI resistors.

$$\begin{aligned} [16] \quad R_B &\approx 20 \times (V_{INMAX} - 7V) \text{ (k}\Omega) \\ &\approx 20 \times (54 - 7) = 940\text{k}, \text{ use } 953\text{k}\Omega \end{aligned}$$

$$\begin{aligned} [17] \quad R_A &= \frac{7V \times R_B}{V_{TL} - 7V} \\ &= 7 \times 953\text{k} / (42 - 7) = 191\text{k}\Omega \end{aligned}$$

$$\begin{aligned} [18] \quad R_H &= \frac{R_A \times R_B \times 7}{R_A \times (V_{TH} - 7V) - (7V \times R_B)} \\ &= \frac{191\text{k} \times 953\text{k} \times 7}{191\text{k} \times (44 - 7) - (7 \times 953\text{k})} \\ &= 3218\text{k}, \text{ use } 3.3\text{M} \end{aligned}$$



# -48V to +5V Output Switching DC-DC Converter

**MAX650**

**Table 1. Transformer and Resistor Selection Guide**

SUPPLY V (NEGATIVE)	R <sub>BD</sub> (k $\Omega$ )	I <sub>OUT</sub> (mA AT 5V)	MANUFACTURER	MODEL #	PRIMARY L TURNS RATIO (PRI:SEC)	
42 to 54	4.3*	250	Schott Corp.	67122480	6.45mH	8:1
42 to 54	22*	100	Schott Corp.	67122490	16.0mH	8:1

\* Use 0.1 $\mu$ F from BD to GND, R<sub>NEG</sub> = 56k, R<sub>OSC</sub> = 3.6M, Schott Corporation: (615) 889-8800.

## Chip Topography

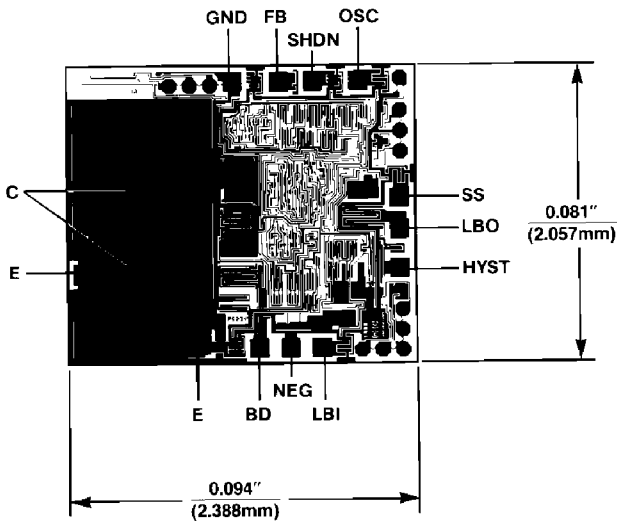

# -48V to +5V Output Switching DC-DC Converter

## Package Information

MAX650

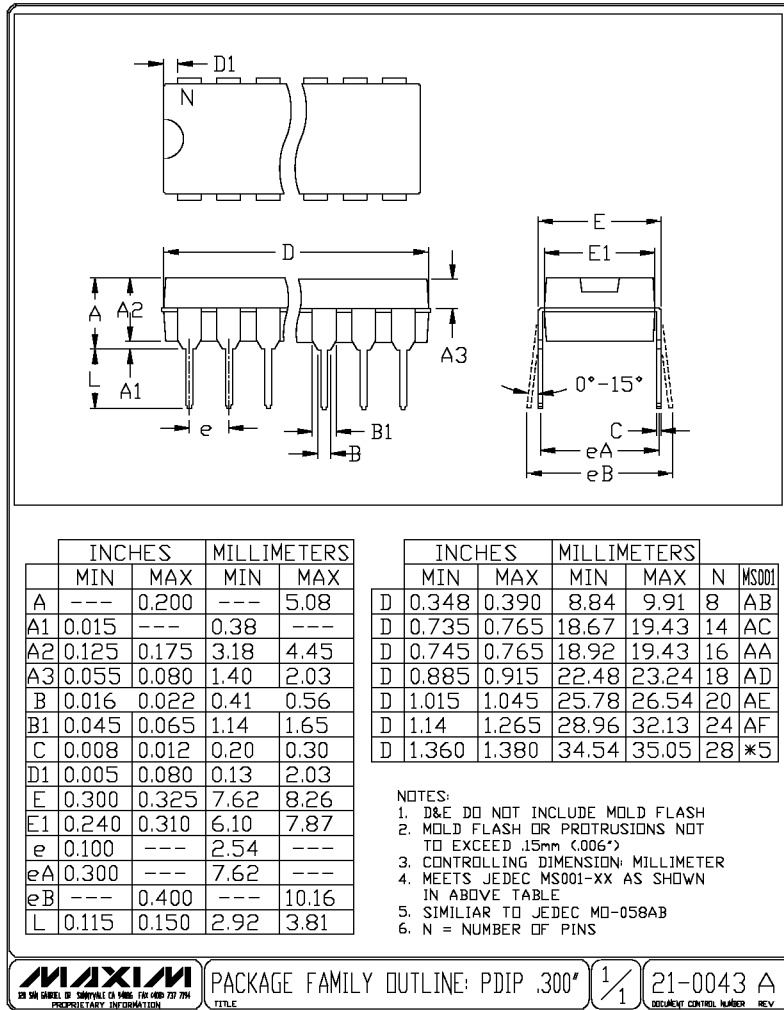

# -48V to +5V Output Switching DC-DC Converter

Package Information (continued)

MAX650

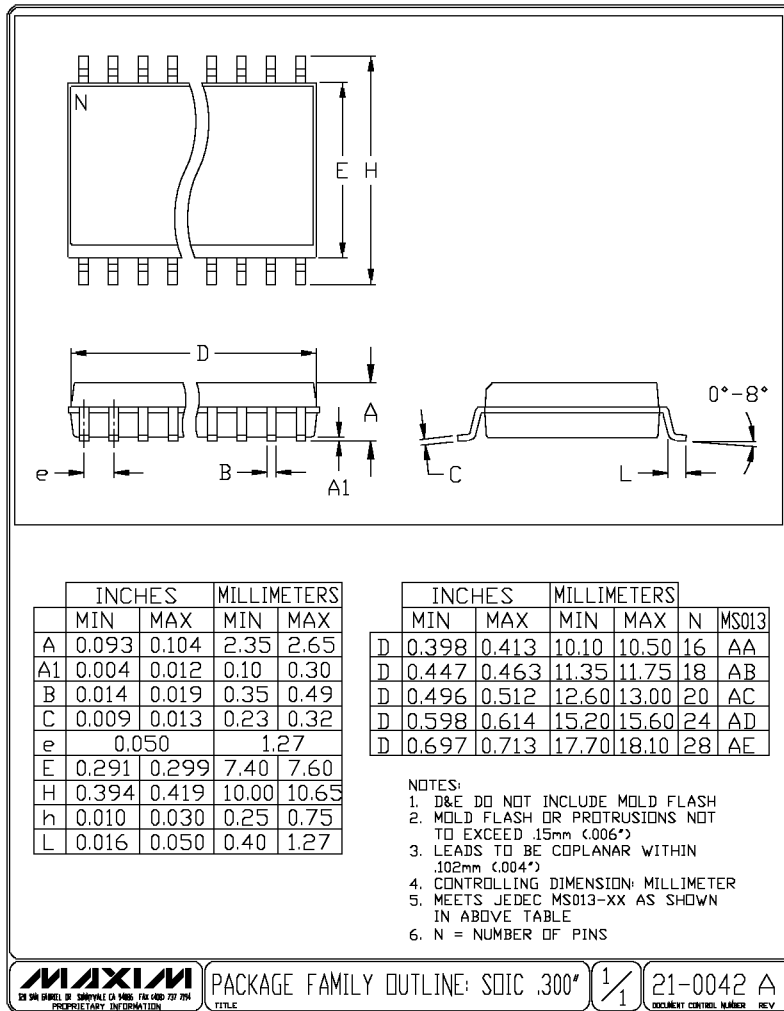

# -48V to +5V Output Switching DC-DC Converter

Package Information (continued)

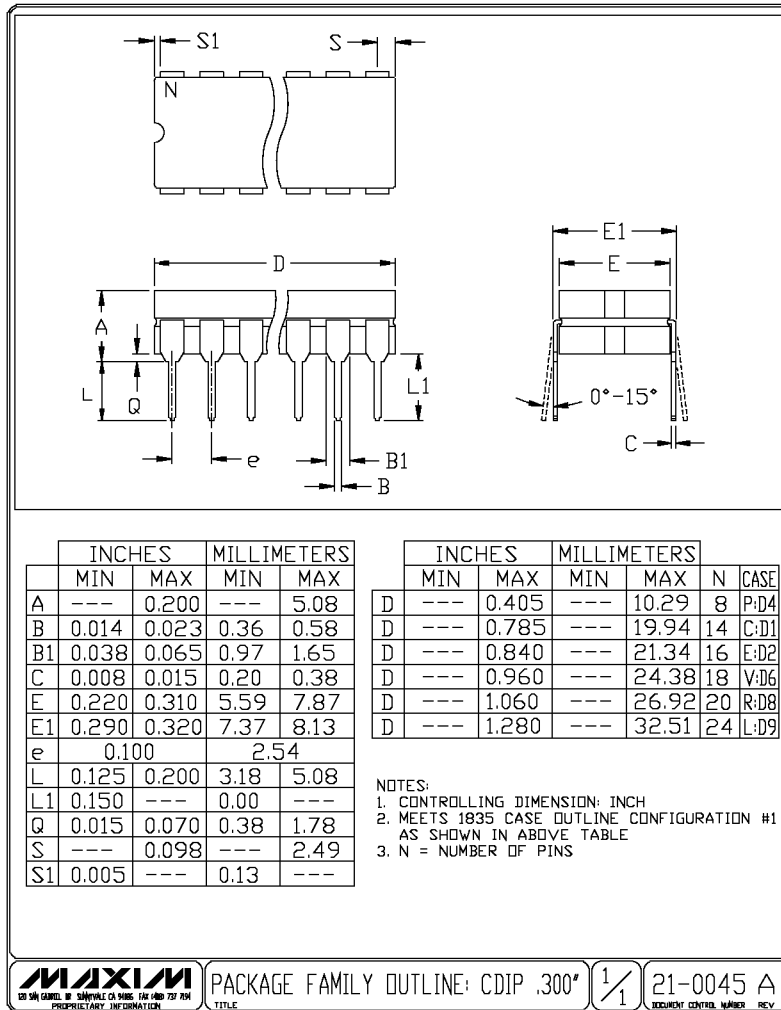

PACKAGE FAMILY OUTLINE: CDIP .300"



21-0045 A

Maxim cannot assume responsibility for use of any circuitry other than circuitry entirely embodied in a Maxim product. No circuit patent licenses are implied. Maxim reserves the right to change the circuitry and specifications without notice at any time.

12 Maxim Integrated Products, 120 San Gabriel Drive, Sunnyvale, CA 94086 408-737-7600