

LEGEND  = KEY PRODUCT CHARACTERISTICS

REVISION HISTORY				
REV	DESCRIPTION	BY	DATE	CHG No
0	FIRST ISSUED	MH	18-09-14	----

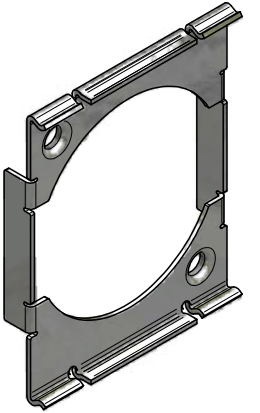

3D VIEW

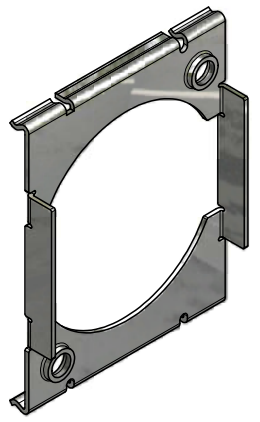
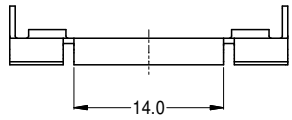
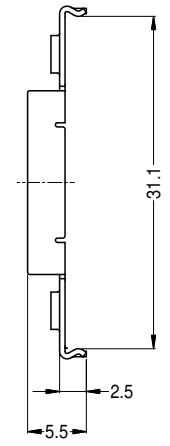
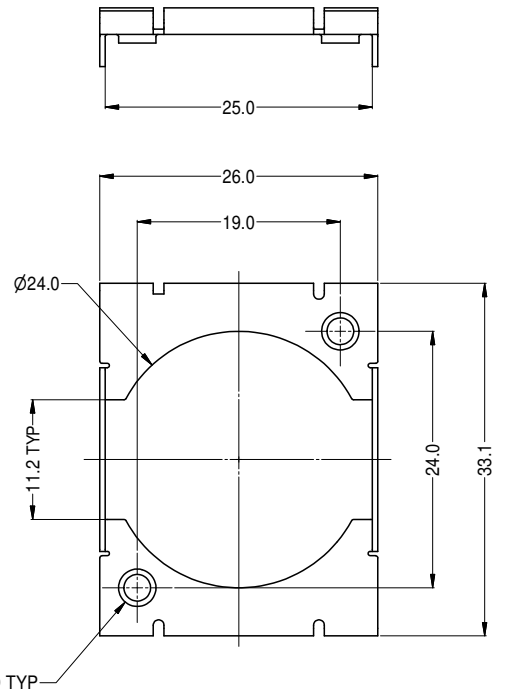
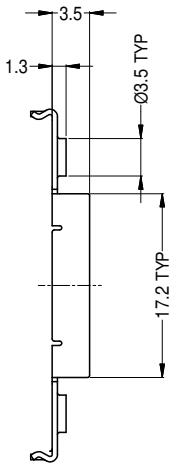

- NOTES:
1. MATERIAL: 0.5MM THICK SPRING STEEL.
 2. FINISH: MIN 2um NICKEL PLATED.
 3. ALL MATERIAL SHALL BE RoHS COMPLIANT.

UNLESS OTHERWISE SPECIFIED TOLERANCE TO BE		THIS DOCUMENT IS THE PROPERTY OF AMPHENOL AUSTRALIA PTY. LTD. NO PART THEREOF MAY BE REPRODUCED AND USED WITHOUT THE PRIOR WRITTEN CONSENT OF THE OWNER				Amphenol Amphenol Australia Pty.Ltd, 22 Industry Blvd, Carrum Downs, VIC 3201	
LINER	ANGULAR	MATERIAL:	DRN:	DATE:	TITLE:	PART No:	
X ± 0.5	X' ± 1	0.5mm THICK SPRING STEEL	MH	18-09-14	M3x0.5mm THREAD REAR PANEL CLIP CUSTOMER DRAWING	52590060-300	
XX ± 0.25	XX' ± 30'	FINISH: NICKEL PLATED	CKD:	DATE:			
XXX ± 0.1	XXX' ± 15'		MH	18-09-14			
BREAK ALL SHARP EDGES AND REMOVE ALL BURRS		APPD:	DATE:				
DO NOT SCALE		PM	18-09-14				
DIMENSIONS IN MILLIMETRES		SCALE:	SIZE:	CAD FILE:	DRAWING NO.	SHEET	
		2:1	A3	52590060300110	52590060-300-1	2/2	