

A

20PIN

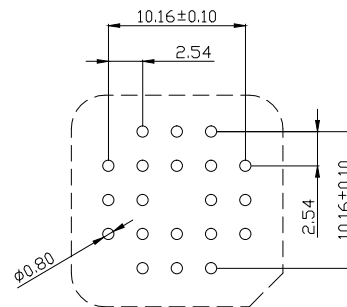
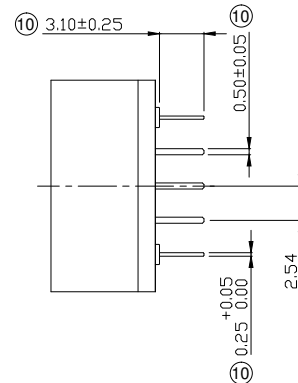
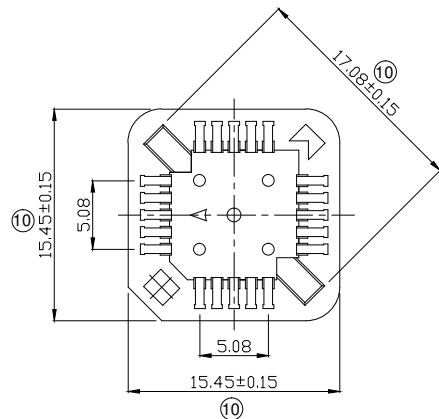

Recommended P.C.B Layout

NOTES:

- 1.MATERIAL
 - ⑩ 1.1 Housing:PPS Glass Fiber filled,UL94 V-0,Black
 - 1.2 Contact:Phosphor Bronze,T=0.25mm
- 2.FINISH
 - ⑩ 2.1 Contact:Matte Tin 20-200u" over Ni 15-80u"
- 3.MECHANICAL
 - ⑩ 3.1 Mating Force:4Kg-f Max.
 - ⑩ 3.2 Unmating Force:0.70Kg-f Min.
 - ⑩ 3.3 Durability (mating cycles):200 cycles Min.
- 4.ELECTRICAL
 - ⑩ 4.1 Rated Current:1.0 Amp
 - ⑩ 4.2 Rated Voltage:125~250 V
 - ⑩ 4.3 Withstand Voltage:600V for 1 minute
 - ⑩ 4.4 Contact Resistance:20mΩ Max.
 - 4.5 Insulation Resistance:1000MΩ Min.
- 5.ENVIRONMENTAL
 - 5.1 Operating Temperature:-40°C To +105°C
 - ⑩ 5.2 High Temperature Resistance:260±5°C 10S
- 6.Packing:Tube

B

C

D

E

F

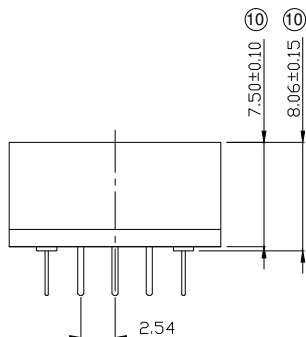

G

RoHS compliant
unit:mm

Scale	Free	⑩	Change the plant	10.07.2023	Peter		Date	Name
TOLERANCE		⑨	Update dimension and shape	17.05.2022	Daniel	Drawn	08.05.2003	Hellwig
X.	±0.50	⑧	Update dimension 2.75mm to 3.20mm	10.06.2020	Winnie	Approved	10.07.2023	Peter
X.X	±0.20	⑦	Add Pin-out diagram	02.08.2018	Xavier			
X.XX	±0.10	⑥	Update the plating spec	11.05.2018	Segal			
Dim	TOL	⑤	Add the stand off	27.04.2018	Winnie			
X°	±1°	Id.	Modification	Date	Name			
Angle	TOL							

Description: PLCC Socket Connector
20Pin Pitch 1.27mm Straight THT

ASSMANN WSW-No.
A-CCS 020-Z-T

Drawing-No.
ASS 0981 CO rev10

Customer No. Sheet
1/2

H

1 2 3 4 5 6 7

A

28-84 PIN

B

C

D

E

F

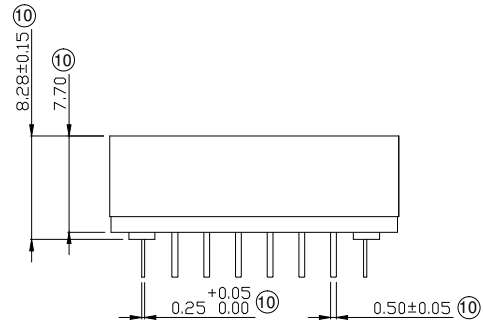
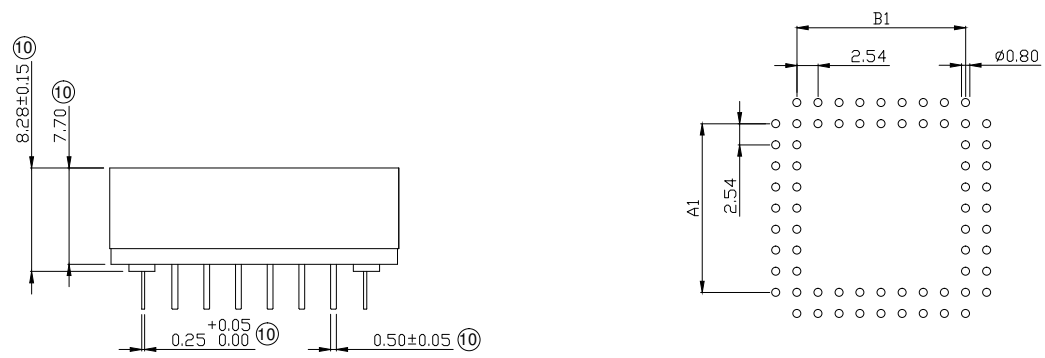
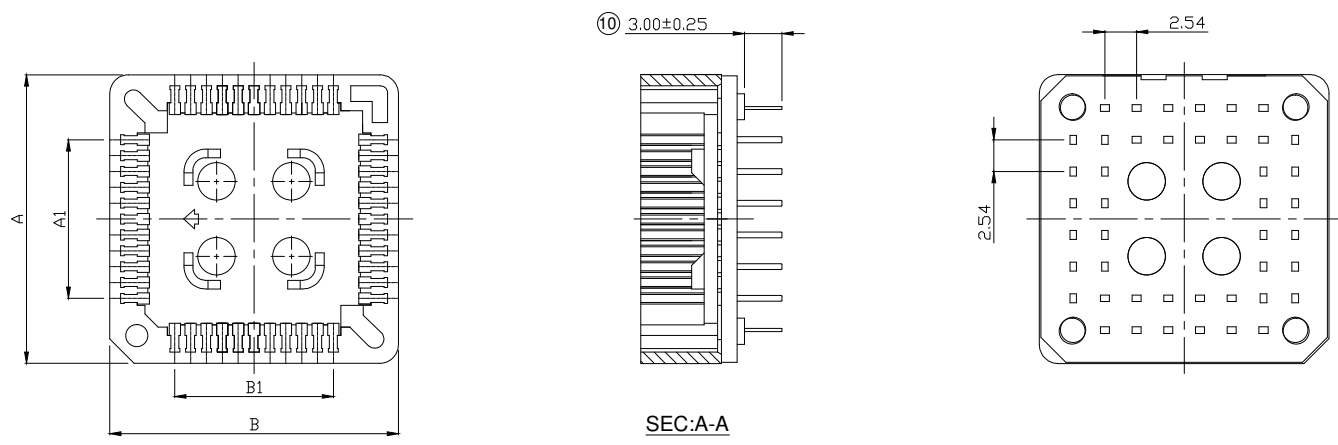

Pin Count	Dimension			
	Dim A	Dim A1	Dim B	Dim B1
28	18.00	7.62	18.00	7.62
32	18.10	7.62	20.65	10.16
44	23.05	12.70	23.05	12.70
52	25.70	15.24	25.70	15.24
68	30.80	20.32	30.80	20.32
84	36.00	25.40	36.00	25.40

G

H

RoHS compliant
unit:mm

Scale	Free	⑩	Change the plant	10.07.2023	Peter		Date	Name
TOLERANCE		⑨	Update dimension and shape	17.05.2022	Daniel	Drawn	08.05.2003	Hellwig
X.	±0.50	⑧	Update dimension 2.75mm to 3.20mm	10.06.2020	Winnie	Approved	10.07.2023	Peter
X.X	±0.20	⑦	Add Pin-out diagram	02.08.2018	Xavier			
X.XX	±0.10	⑥	Update the plating spec	11.05.2018	Segal			
Dim	TOL	⑤	Add the stand off	27.04.2018	Winnie			
X°	±1°	④						
Angle	TOL	③						
		②						
		①						

Description: PLCC Socket Contact Pitch 2.54mm Straight THT	
ASSMANN WSW-No. A-CCS 0xx-Z-T	
Drawing-No. ASS 0981 CO	rev10
Customer No.	Sheet 2/2



1 2 3 4 5 6 7