



Features

- Wide input range 100~305V AC(Class I)
- Full power output at 70~100% Constant power mode operation
- Metal case with IP67, suitable for outdoor application
- Surge protection with 6KV/4KV (10KV/6KV optional)
- 3 in 1 dimming function (Dim to off and Isolation design)
- India (EESL) version with Input Over Voltage Protection can survive input voltage stress of 440Vac for 48 hours
- Protection functions: OVP/SCP/OCP/OTP
- Life time >50,000 hrs. and 5 years warranty

Applications

- Skyscraper lighting
- Street lighting
- Floodlight Lighting
- Stage lighting
- Fishing lighting
- Horticulture lighting
- Bay lighting
- DMX power supply
- Type HL for use in class I, Division 2

GTIN CODE

MW Search: <https://www.meanwell.com/serviceGTIN.aspx>

Description

XLG-200 series is a 200W LED AC/DC driver featuring the constant power mode. XLG-200 operates from 100~305VAC and offers models with different rated current ranging between 700mA and 16A. Thanks to the high efficiency up to 94%, with the fanless design, the entire series is able to operate for -40°C ~+90°C case temperature under free air convection. The design of metal housing and IP67 ingress protection level allows this series to fit both indoor and outdoor applications. Moreover the innovative environment-adaptive capability allows this series to reliably light on the LEDs for all kinds of application environments in almost any spots that may install LED luminaires in the world. XLG-200 series comply with the latest version of IEC61347/GB19510.1 and UL8750 international safety regulations. The output and dimming circuit are also completely in accordance with the new regulations with isolation to ensure the safety of both user and luminaire system during installation.

Model Encoding

XLG - 200 I - L - □

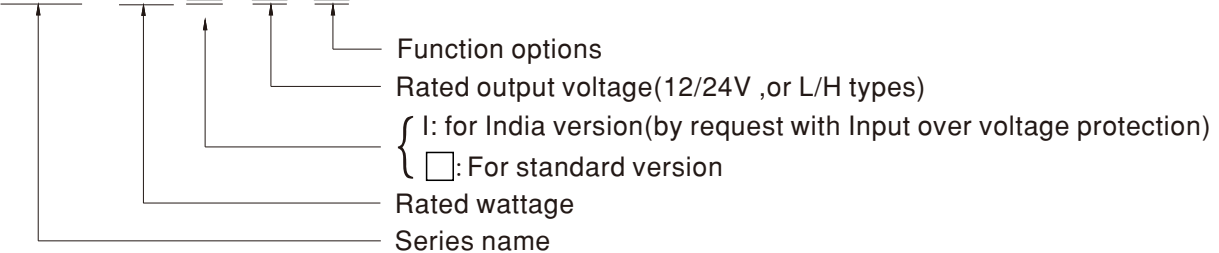

Type	Function	Note
Blank	Io and Vo fixed. (For harsh environment)	By request
A	Io adjustable via built-in potentiometer	In Stock
AB	Io adjustable via built-in potentiometer + 3 in 1 dimming function (0~10Vdc, 10V PWM signal and resistance)	In Stock

Note: 1. 12V and 24V models without AB type

2. India version needs MOQ for production, please consult MEANWELL for detail

SPECIFICATION

MODEL		XLG-200□-12-□	XLG-200□-24-□	
OUTPUT	DC VOLTAGE	12V	24V	
	CONSTANT CURRENT REGION <small>Note.2</small>	8.4~ 12V	16.8~ 24V	
	RATED CURRENT (Default)	16A	8.3A	
	RATED POWER	192W	199.2W	
	RIPPLE & NOISE (max.) <small>Note.3</small>	150mVp-p	240mVp-p	
	CURRENT ADJ. RANGE	Adjustable for A-Type only (via the built-in potentiometer)		
		8 ~ 16A	4.15 ~ 8.3A	
	VOLTAGE TOLERANCE <small>Note.4</small>	±3.0%	±2.0%	
	LINE REGULATION	±0.5%	±0.5%	
	LOAD REGULATION	±2%	±1%	
SETUP, RISE TIME <small>Note.6</small>	500ms, 100ms/230VAC, 1200ms, 100ms/115VAC			
HOLD UP TIME (Typ.)	10ms/ 230VAC 10ms/ 115VAC			
INPUT	VOLTAGE RANGE <small>Note.5</small>	100 ~ 305VAC 142 ~ 431VDC (Please refer to "STATIC CHARACTERISTIC" section)		
	FREQUENCY RANGE	47 ~ 63Hz		
	POWER FACTOR	PF ≥ 0.97/115VAC, PF ≥ 0.95/230VAC, PF ≥ 0.92/277VAC@full load		
	TOTAL HARMONIC DISTORTION	THD < 10% (@load ≥ 50%/115VAC, 230VAC; @load ≥ 75%/277VAC)		
	EFFICIENCY (Typ.)	92%	94%	
	AC CURRENT	2.2A / 115VAC 1.1A / 230VAC 0.9A/277VAC		
	INRUSH CURRENT(Typ.)	COLD START 65A(twidth=550µs measured at 50% Ipeak) at 230VAC; Per NEMA 410		
	MAX. No. of PSUs on 16A CIRCUIT BREAKER	3 units (circuit breaker of type B) / 6 units (circuit breaker of type C) at 230VAC		
	LEAKAGE CURRENT	<0.75mA / 277VAC		
	NO LOAD POWER CONSUMPTION	No load power consumption <0.5W(for standard version)		
PROTECTION	OVER CURRENT	95 ~ 108% Hiccup mode or constant current limiting, recovers automatically after fault condition is removed		
	SHORT CIRCUIT	Hiccup mode or constant current limiting, recovers automatically after fault condition is removed		
	OVER VOLTAGE	13.5 ~ 18V	27 ~ 34V	
		Shut down output voltage, re-power on to recover		
	INPUT OVER VOLTAGE <small>Note.7</small>	320 ~ 390VAC (Shut down output voltage when the input voltage exceeds protection voltage, recovers automatically after fault condition is removed) Can survive input voltage stress of 440Vac for 48 hours		
OVER TEMPERATURE	Shut down output voltage, re-power on to recover			
ENVIRONMENT	WORKING TEMP.	Tcase=-40 ~ +90°C (Please refer to " OUTPUT LOAD vs TEMPERATURE" section)		
	MAX. CASE TEMP.	Tcase=+90°C		
	WORKING HUMIDITY	20 ~ 95% RH non-condensing		
	STORAGE TEMP., HUMIDITY	-40 ~ +80°C, 10 ~ 95% RH		
	TEMP. COEFFICIENT	±0.03%/°C (0 ~ 60°C)		
VIBRATION	10 ~ 500Hz, 5G 12min./1cycle, period for 72min. each along X, Y, Z axes			
EMC SAFETY &	SAFETY STANDARDS <small>Note.7</small>	UL8750(type"HL"), CSA C22.2 No. 250.13-12; ENEC BS EN/EN61347-1, BS EN/EN61347-2-13 independent, BS EN/EN62384; GB19510.1, GB19510.14; EAC TP TC 004; J61347-1(H29), J61347-2-13(H29), KC61347-1, KC61347-2-13, IS15885(Part2/Sec13)(for XLG-200I type only); NOM-058-SCFI-2017(except for Blank type); IP67 approved		
	WITHSTAND VOLTAGE	I/P-O/P:3.75KVAC I/P-FG:2KVAC O/P-FG:1.5KVAC		
	ISOLATION RESISTANCE	I/P-O/P, I/P-FG, O/P-FG:100M Ohms / 500VDC / 25°C / 70% RH		
	EMC EMISSION	Parameter	Standard	Test Level/Note
		Conducted	BS EN/EN55015(CISPR15) ,GB/T17743	-----
		Radiated	BS EN/EN55015(CISPR15) ,GB/T17743	-----
		Harmonic Current	BS EN/EN61000-3-2 ,GB/T17625.1	Class C @load ≥ 50%
	EMC IMMUNITY	Volume Flicker	BS EN/EN61000-3-3	-----
		Parameter	Standard	Test Level/Note
		ESD	BS EN/EN61000-4-2	Level 3, 8KV air ; Level 2, 4KV contact
Radiated		BS EN/EN61000-4-3	Level 3	
EFT/Burst		BS EN/EN61000-4-4	Level 3	
Surge		BS EN/EN61000-4-5	4KV/Line-Line 6KV/Line-Earth(6K/10K option)	
Conducted		BS EN/EN61000-4-6	Level 3	
Magnetic Field		BS EN/EN61000-4-8	Level 4	
Volume Dips and Interruptions	BS EN/EN61000-4-11	>95% dip 0.5 periods, 30% dip 25 periods, >95% interruptions 250 periods		
OTHERS	MTBF	2300.1K hrs min. Telcordia SR-332 (Bellcore) ; 200.7Khrs min. MIL-HDBK-217F (25°C)		
	DIMENSION	199*63*35.5mm (L*W*H)		
	PACKING	0.85Kg;16pcs /14.2Kg /0.75CUFT		
NOTE	<p>1. All parameters NOT specially mentioned are measured at 230VAC input, rated current and 25°C of ambient temperature.</p> <p>2. Please refer to "DRIVING METHODS OF LED MODULE".</p> <p>3. Ripple & noise are measured at 20MHz of bandwidth by using a 12" twisted pair-wire terminated with a 0.1µf & 47µf parallel capacitor.</p> <p>4. Tolerance : includes set up tolerance, line regulation and load regulation.</p> <p>5. De-rating may be needed under low input voltages. Please refer to "STATIC CHARACTERISTIC" sections for details.</p> <p>6. Length of set up time is measured at first cold start. Turning ON/OFF the driver may lead to increase of the set up time.</p> <p>7. Input over voltage only for XLG-200 I series, and I series without UL/CSA certificate.</p> <p>8. The driver is considered as a component that will be operated in combination with final equipment. Since EMC performance will be affected by the complete installation, the final equipment manufacturers must re-qualify EMC Directive on the complete installation again.</p> <p>9. This series meets the typical life expectancy of >50,000 hours of operation when Tcase, particularly (Tc) point (or TMP, per DLC), is about 75°C or less.</p> <p>10. Please refer to the warranty statement on MEAN WELL's website at http://www.meanwell.com</p> <p>11. The ambient temperature derating of 3.5°C/1000m with fanless models and of 5°C/1000m with fan models for operating altitude higher than 2000m(6500ft).</p> <p>12. Products sourced from the Americas regions may not have the CCC/PSE/BIS/KC logo. Please contact your MEAN WELL sales for more information.</p> <p>13. For any application note and IP water proof function installation caution, please refer our user manual before using. https://www.meanwell.com/Upload/PDF/LED_EN.pdf</p> <p>14. To fulfill requirements of the latest ErP regulation for lighting fixture, this LED driver can only be used behind a switch without permanently connected to the mains.</p> <p>15. If you need the NOM (Mexico) certificate, Please contact MEAN WELL sales representative for details.</p> <p>※ Product Liability Disclaimer : For detailed information, please refer to https://www.meanwell.com/serviceDisclaimer.aspx File Name:XLG-200-SPEC 2023-05-17</p>			

SPECIFICATION

MODEL		XLG-200□-L-□	XLG-200□-H-□	
OUTPUT	RATED CURRENT (Default)	700mA	3500mA	
	RATED POWER	200W	200W	
	CONSTANT CURRENT REGION <small>Note.2</small>	142~285V	27~56V	
	FULL POWER CURRENT RANGE	700~1050mA	3500~5550mA	
	OPEN CIRCUIT VOLTAGE (max.)	300V	60V	
	CURRENT ADJ. RANGE	Adjustable for A/AB-Type only (via the built-in potentiometer)		
		350~1050mA	1750~5550mA	
	CURRENT RIPPLE	3.0%(@ Load ≥ 50% rated voltage)		
	CURRENT TOLERANCE	±5%		
SET UP TIME <small>Note.4</small>	500ms/230VAC, 1200ms/115VAC			
INPUT	VOLTAGE RANGE <small>Note.3</small>	100 ~ 305VAC 142VDC ~ 431VDC (Please refer to "STATIC CHARACTERISTIC" and "DRIVING METHODS OF LED MODULE" section)		
	FREQUENCY RANGE	47 ~ 63Hz		
	POWER FACTOR (Typ.)	PF ≥ 0.97 / 115VAC, PF ≥ 0.95 / 230VAC, PF ≥ 0.92 / 277VAC at full load (Please refer to "Power Factor Characteristic" section)		
	TOTAL HARMONIC DISTORTION	THD < 10% (@ load ≥ 50% at 115VAC/230VAC, @load ≥ 75% at 277VAC) Please refer to "TOTAL HARMONIC DISTORTION (THD)" section		
	EFFICIENCY (Typ.)	94%	93%	
	AC CURRENT (Typ.)	2.2A / 115VAC 1.1A / 230VAC 0.9A / 277VAC		
	INRUSH CURRENT(Typ.)	COLD START 65A(twidth=550µs measured at 50% Ipeak) at 230VAC; Per NEMA 410		
	MAX. NO. of PSUs on 16A CIRCUIT BREAKER	3 unit(circuit breaker of type B) / 6 units(circuit breaker of type C) at 230VAC		
	LEAKAGE CURRENT	<0.75mA / 277VAC		
STANDBY POWER CONSUMPTION	Standby power consumption <0.5W for AB-Type(Dimming OFF)(for standard version)			
PROTECTION	SHORT CIRCUIT	Hiccup mode or Constant current limiting,recovers automatically after fault condition is removed		
	OVER VOLTAGE	301 ~ 360V	61 ~ 85V	
	INPUT OVER VOLTAGE <small>Note.5</small>	320 ~ 390VAC (Shut down output voltage when the input voltage exceeds protection voltage,recovers automatically after fault condition is removed) Can survive input voltage stress of 440Vac for 48 hours		
	OVER TEMPERATURE	Shut down output voltage, re-power on to recover		
ENVIRONMENT	WORKING TEMP.	Tcase=-40 ~ +90°C (Please refer to "OUTPUT LOAD vs TEMPERATURE" section)		
	MAX. CASE TEMP.	Tcase=+90°C		
	WORKING HUMIDITY	20 ~ 95% RH non-condensing		
	STORAGE TEMP., HUMIDITY	-40 ~ +80°C, 10 ~ 95% RH non-condensing		
	TEMP. COEFFICIENT	±0.03%/°C (0 ~ 60°C)		
VIBRATION	10 ~ 500Hz, 5G 12min./1cycle, period for 72min. each along X, Y, Z axes			
SAFETY & EMC	SAFETY STANDARDS <small>Note.5</small>	UL8750(type"HL"), CSA C22.2 No. 250.13-12; BS EN/ENEC BS EN/EN61347-1, BS EN/EN61347-2-13 independent, BS EN/EN62384;GB19510.1, GB19510.14;EAC TP TC 004; J61347-1(H29), J61347-2-13(H29),KC61347-1,KC61347-2-13,IS15885(Part2/Sec13)(for XLG-200I type only); NOM-058-SCFI-2017(except for Blank type);IP67 approved		
	WITHSTAND VOLTAGE	I/P-O/P:3.75KVAC I/P-FG:2KVAC O/P-FG:1.5KVAC		
	ISOLATION RESISTANCE	I/P-O/P, I/P-FG, O/P-FG:100M Ohms / 500VDC / 25°C/ 70% RH		
	EMC EMISSION	Compliance to BS EN/EN55015, BS EN/EN61000-3-2 Class C (@ load ≥ 50%); BS EN/EN61000-3-3		
	EMC EMISSION	Parameter	Standard	Test Level/Note
		Conducted	BS EN/EN55015(CISPR15) ,GB/T17743	----
		Radiated	BS EN/EN55015(CISPR15) ,GB/T17743	----
		Harmonic Current	BS EN/EN61000-3-2 ,GB/T17625.1	Class C @load≥50%
	EMC IMMUNITY	Voltage Flicker	BS EN/EN61000-3-3	----
		Parameter	Standard	Test Level/Note
ESD		BS EN/EN61000-4-2	Level 3, 8KV air ; Level 2, 4KV contact	
Radiated		BS EN/EN61000-4-3	Level 3	
EFT/Burst		BS EN/EN61000-4-4	Level 3	
Surge		BS EN/EN61000-4-5	4KV/Line-Line 6KV/Line-Earth(6K/10K option)	
Conducted		BS EN/EN61000-4-6	Level 3	
Magnetic Field		BS EN/EN61000-4-8	Level 4	
Voltage Dips and Interruptions	BS EN/EN61000-4-11	>95% dip 0.5 periods, 30% dip 25 periods, >95% interruptions 250 periods		
OTHERS	MTBF	2300.1K hrs min. Telcordia SR-332 (Bellcore) ; 200.7Khrs min. MIL-HDBK-217F (25°C)		
	DIMENSION	199*63*35.5mm (L*W*H)		
	PACKING	0.85Kg;16pcs/14.2Kg/0.75CUFT		
NOTE	<ol style="list-style-type: none"> All parameters NOT specially mentioned are measured at 230VAC input, rated current and 25°C of ambient temperature. Please refer to "DRIVING METHODS OF LED MODULE". De-rating may be needed under low input voltages. Please refer to "STATIC CHARACTERISTIC" sections for details. Length of set up time is measured at first cold start. Turning ON/OFF the driver may lead to increase of the set up time. Input over voltage only for XLG-200 I series, and I series without UL/CSA certificate. The driver is considered as a component that will be operated in combination with final equipment. Since EMC performance will be affected by the complete installation, the final equipment manufacturers must re-qualify EMC Directive on the complete installation again. This series meets the typical life expectancy of >50,000 hours of operation when Tcase, particularly (Tc)point (or TMP, per DLC), is about 75°C or less. Please refer to the warranty statement on MEAN WELL's website at http://www.meanwell.com The ambient temperature derating of 3.5°C/1000m with fanless models and of 5°C/1000m with fan models for operating altitude higher than 2000m(6500ft). To fulfill requirements of the latest ErP regulation for lighting fixtures, this LED driver can only be used behind a switch without permanently connected to the mains. Products sourced from the Americas regions may not have the CCC/PSE/BIS/KC logo. Please contact your MEAN WELL sales for more information. For any application note and IP water proof function installation caution, please refer our user manual before using. https://www.meanwell.com/Upload/PDF/LED_EN.pdf Ripple & noise are measured at 20MHz of bandwidth by using a 12" twisted pair-wire terminated with a 0.1µf & 47µf parallel capacitor. To fulfill requirements of the latest ErP regulation for lighting fixture, this LED driver can only be used behind a switch without permanently connected to the mains. If you need the NOM (Mexico) certificate, Please contact MEAN WELL sales representative for details. <p>※ Product Liability Disclaimer : For detailed information, please refer to https://www.meanwell.com/serviceDisclaimer.aspx</p>			

■ BLOCK DIAGRAM

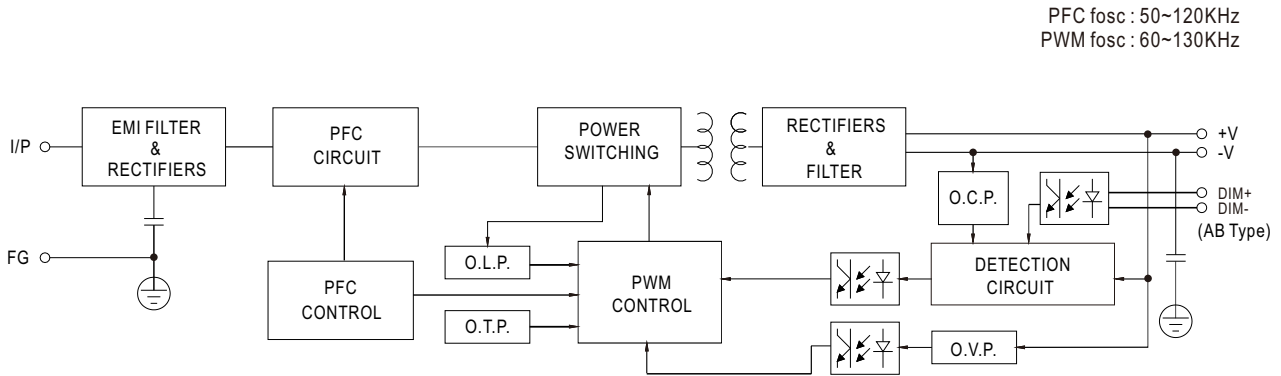

■ DRIVING METHODS OF LED MODULE

※ I-V Operating Area

◎ XLG-200-L

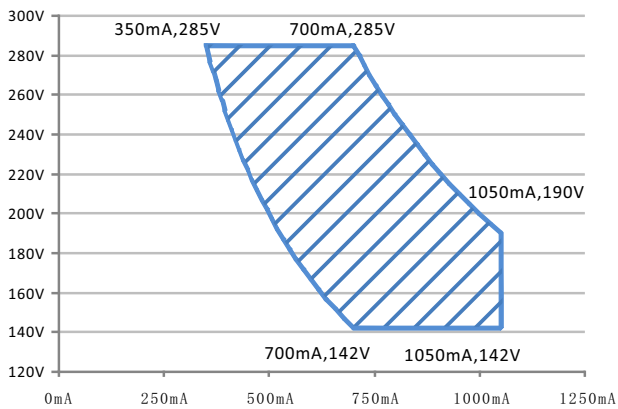

◎ XLG-200-H

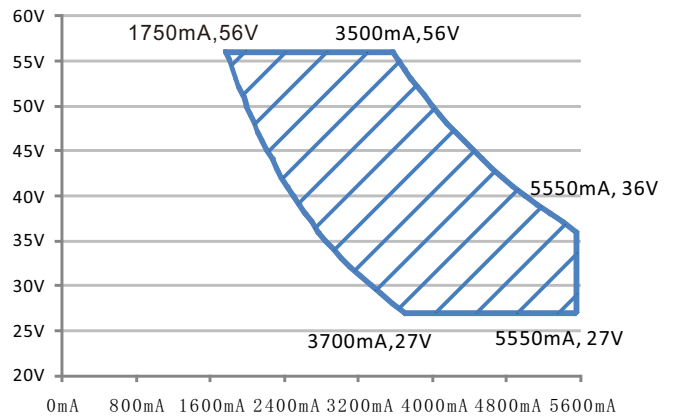

Recommend Performance Region

Recommend Performance Region

◎ XLG-200-12,24

※ This series is able to work in either Constant Current mode (a direct drive way) or Constant Voltage mode (usually through additional DC/DC driver) to drive the LEDs.

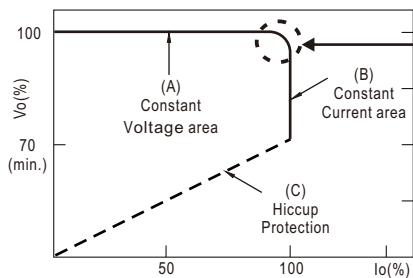

In the constant current region, the highest voltage at the output of the driver depends on the configuration of the end systems.

Should there be any compatibility issues, please contact MEAN WELL.

Typical output current normalized by rated current (%)

DIMMING OPERATION

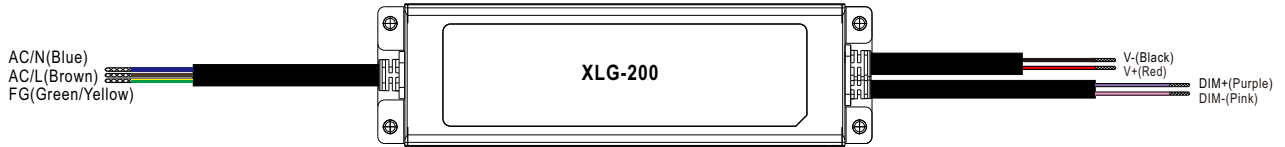

※ 3 in 1 dimming function (for AB-Type)

- Output constant current level can be adjusted by applying one of the three methodologies between DIM+ and DIM-: 0 ~ 10VDC, or 10V PWM signal or resistance.
- Direct connecting to LEDs is suggested. It is not suitable to be used with additional drivers.
- Dimming source current from power supply: 100 μ A (typ.)

◎ Applying additive 0 ~ 10VDC

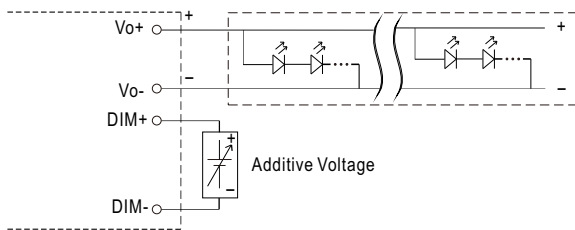

"DO NOT connect "DIM- to Vo-"

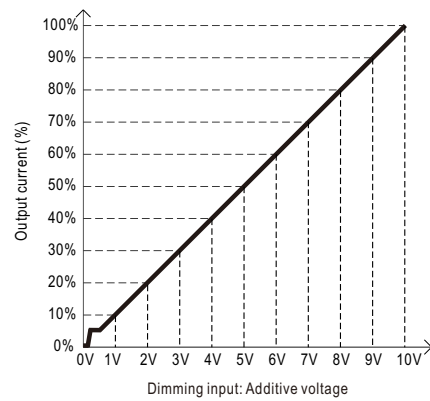

◎ Applying additive 10V PWM signal (frequency range 100Hz ~ 3KHz):

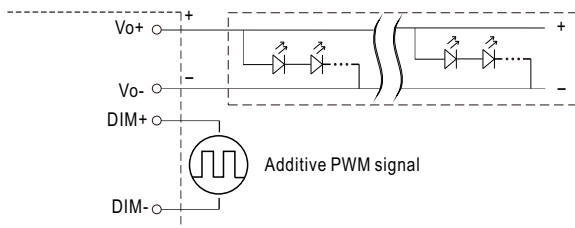

"DO NOT connect "DIM- to Vo-"

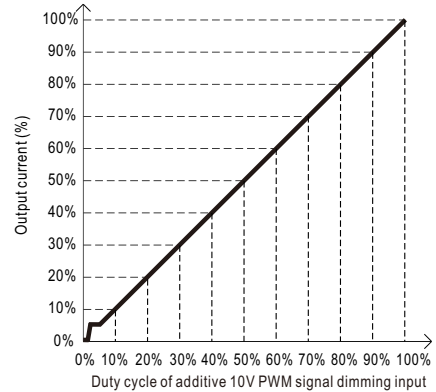

◎ Applying additive resistance:

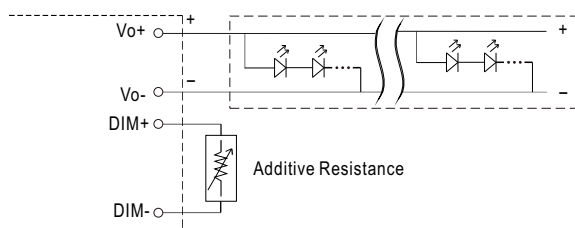

"DO NOT connect "DIM- to Vo-"

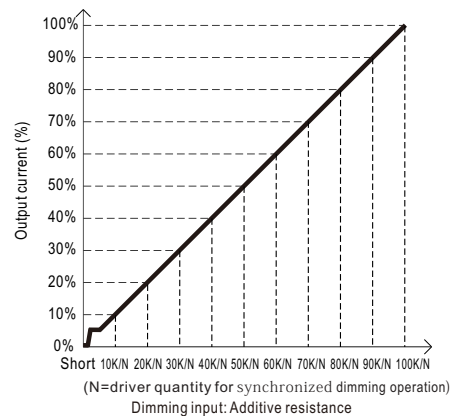

Note : 1. Min. dimming level is about 8% and the output current is not defined when 0% < I_{out} < 8%.

2. The output current could drop down to 0% when dimming input is about 0kΩ or 0Vdc, or 10V PWM signal with 0% duty cycle.

OUTPUT LOAD vs TEMPERATURE

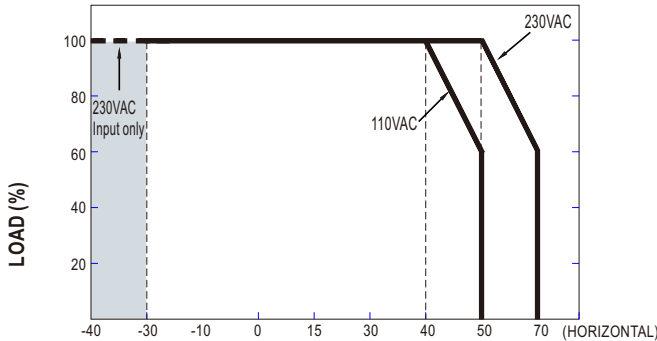

AMBIBS EN/ENT TEMPERATURE, Ta (°C)

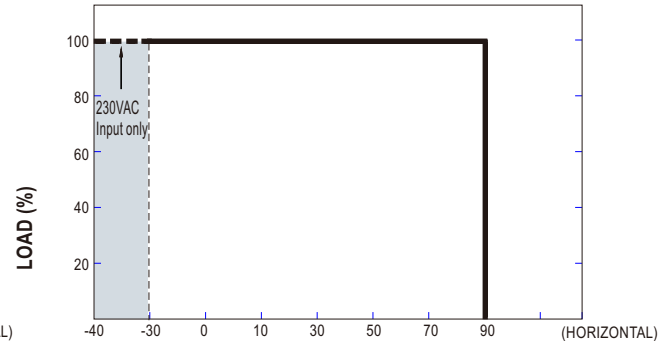

Tcase (°C)

If XLG-200 operates in Constant Power mode with the rated current the maximum workable Ta is 50°C (Typ. 230VAC) or 40°C (typ.110VAC)
Below 110VAC@30°C may retry to 2nd setup

STATIC CHARACTERISTIC

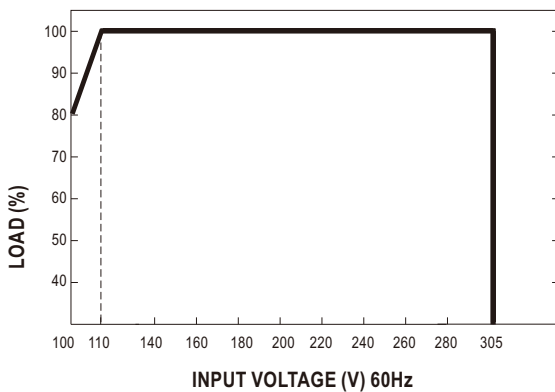

INPUT VOLTAGE (V) 60Hz

POWER FACTOR (PF) CHARACTERISTIC

※ Tcase at 75°C

Constant Current Mode

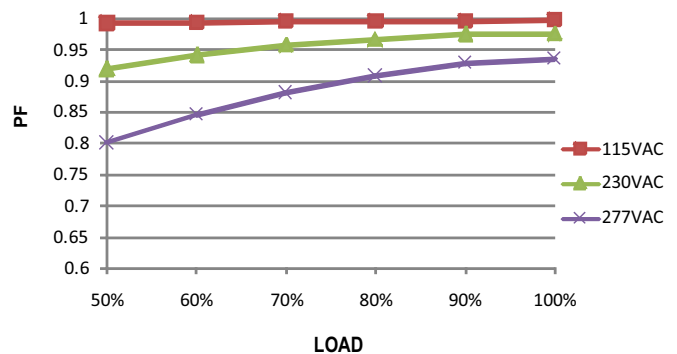

TOTAL HARMONIC DISTORTION (THD)

※ XLG-200-L Model, Tcase at 75°C

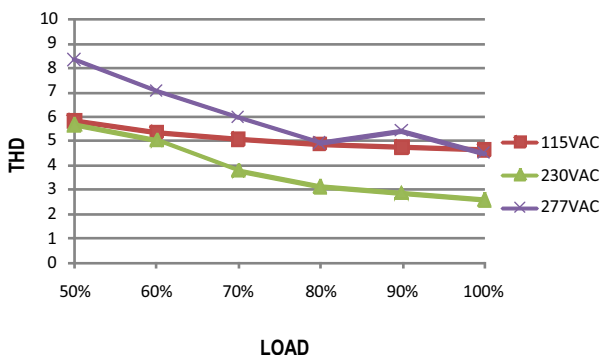

EFFICIENCY vs LOAD

XLG-200 series possess superior working efficiency that up to 94% can be reached in field applications.

※ XLG-200-L Model, Tcase at 75°C

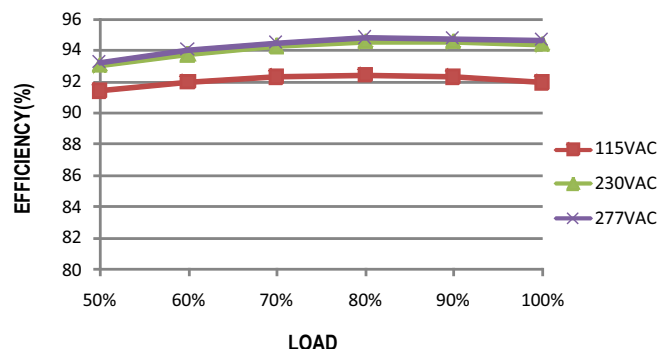



■ LIFE TIME

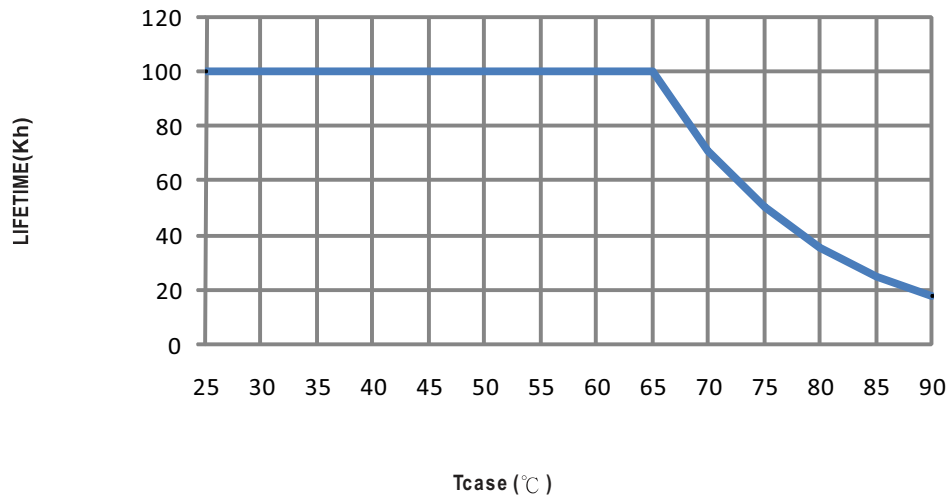

MECHANICAL SPECIFICATION

Case No.:244A Unit:mm

※ Blank-Type

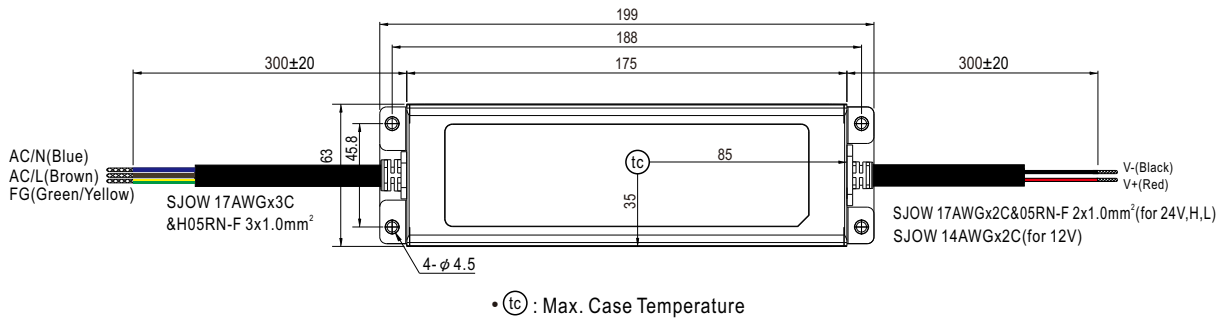

※ A-Type

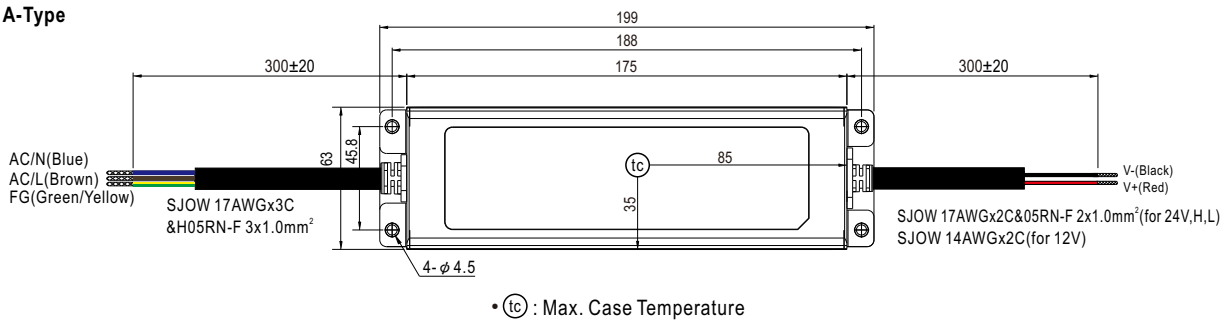

※ **AB-Type**

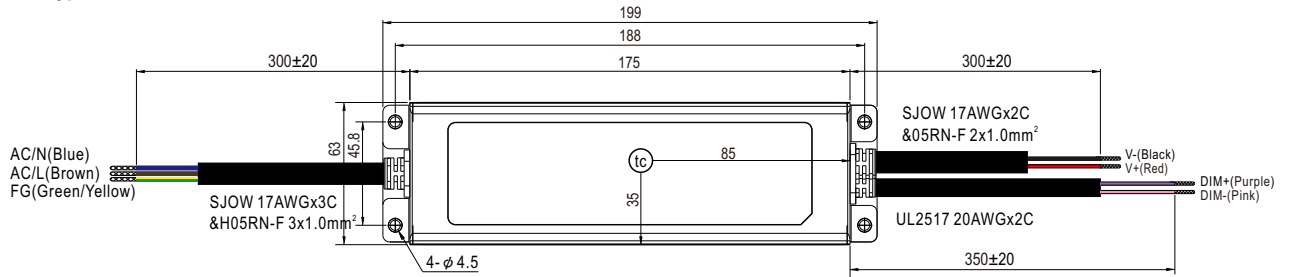

• t_c : Max. Case Temperature

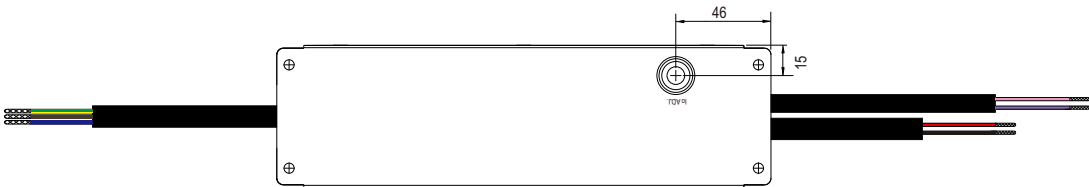
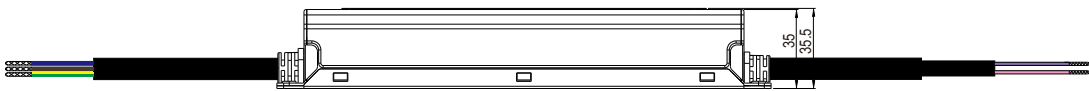

■ **INSTALLATION MANUAL**

Please refer to : <http://www.meanwell.com/manual.html>