

GC2X10MPS12-247

1200V 20A SiC Schottky MPS™ Diode



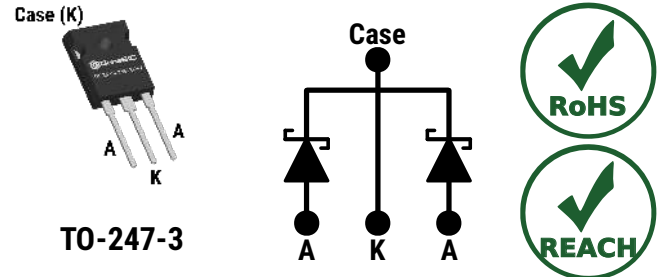
Silicon Carbide Schottky Diode

V_{RRM}	=	1200 V
$I_F(T_C = 158^\circ\text{C})$	=	20 A *
Q_C	=	106 nC *

Features

- Low V_F for High Temperature Operation
- Enhanced Surge and Avalanche Robustness
- Superior Figure of Merit Q_C/I_F
- Low Thermal Resistance
- Low Reverse Leakage Current
- Temperature Independent Fast Switching
- Positive Temperature Coefficient of V_F
- High dV/dt Ruggedness

Package



Advantages

- Improved System Efficiency
- High System Reliability
- Optimal Price Performance
- Reduced Cooling Requirements
- Increased System Power Density
- Zero Reverse Recovery Current
- Easy to Parallel without Thermal Runaway
- Enables Extremely Fast Switching

Applications

- Power Factor Correction (PFC)
- Solar Inverters
- Battery Chargers
- High Frequency Converters
- Switched Mode Power Supply (SMPS)
- AC/DC Power Supplies
- Anti-Parallel / Free-Wheeling Diode
- LED and HID Lighting

Absolute Maximum Ratings (At $T_C = 25^\circ\text{C}$ Unless Otherwise Stated)

Parameter	Symbol	Conditions	Values	Unit	Note
Repetitive Peak Reverse Voltage (Per Leg)	V_{RRM}		1200	V	
Continuous Forward Current (Per Leg / Per Device)	I_F	$T_C = 100^\circ\text{C}, D = 1$	24 / 48	A	Fig. 4
		$T_C = 135^\circ\text{C}, D = 1$	17 / 34		
		$T_C = 158^\circ\text{C}, D = 1$	10 / 20		
Non-Repetitive Peak Forward Surge Current, Half Sine Wave (Per Leg)	$I_{F,SM}$	$T_C = 25^\circ\text{C}, t_P = 10 \text{ ms}$	100	A	
		$T_C = 150^\circ\text{C}, t_P = 10 \text{ ms}$	80		
Repetitive Peak Forward Surge Current, Half Sine Wave (Per Leg)	$I_{F,RM}$	$T_C = 25^\circ\text{C}, t_P = 10 \text{ ms}$	60	A	
		$T_C = 150^\circ\text{C}, t_P = 10 \text{ ms}$	42		
Non-Repetitive Peak Forward Surge Current (Per Leg)	$I_{F,MAX}$	$T_C = 25^\circ\text{C}, t_P = 10 \mu\text{s}$	500	A	
i^2t Value (Per Leg)	$\int i^2 dt$	$T_C = 25^\circ\text{C}, t_P = 10 \text{ ms}$	50	A^2s	
Non-Repetitive Avalanche Energy (Per Leg)	E_{AS}	$L = 3.6 \text{ mH}, I_{AS} = 10 \text{ A}$	180	mJ	
Diode Ruggedness (Per Leg)	dV/dt	$V_R = 0 \sim 960 \text{ V}$	200	V/ns	
Power Dissipation (Per Leg / Per Device)	P_{TOT}	$T_C = 25^\circ\text{C}$	165 / 330	W	Fig. 3
Operating and Storage Temperature	T_j, T_{stg}		-55 to 175	$^\circ\text{C}$	

* Per Device

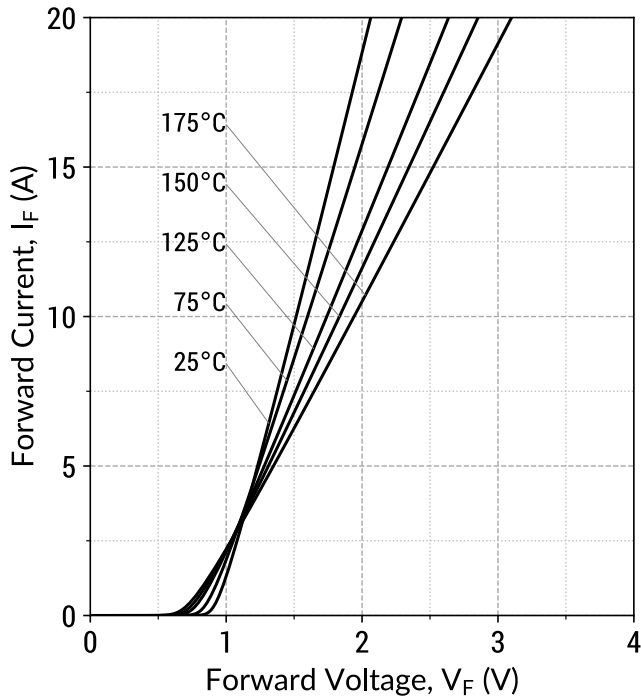
Electrical Characteristics (Per Leg)

Parameter	Symbol	Conditions	Values			Unit	Note
			Min.	Typ.	Max.		
Diode Forward Voltage	V_F	$I_F = 10\text{ A}, T_j = 25^\circ\text{C}$		1.5	1.8	V	Fig. 1
		$I_F = 10\text{ A}, T_j = 175^\circ\text{C}$		1.9			
Reverse Current	I_R	$V_R = 1200\text{ V}, T_j = 25^\circ\text{C}$		1	5	μA	Fig. 2
		$V_R = 1200\text{ V}, T_j = 175^\circ\text{C}$		11			
Total Capacitive Charge	Q_C	$I_F \leq I_{F,MAX}$ $di_F/dt = 200\text{ A}/\mu\text{s}$	$V_R = 400\text{ V}$		37	nC	Fig. 7
			$V_R = 800\text{ V}$		53		
Switching Time	t_s		$V_R = 400\text{ V}$ $V_R = 800\text{ V}$	< 10		ns	
Total Capacitance	C	$V_R = 1\text{ V}, f = 1\text{ MHz}$		609		pF	Fig. 6
		$V_R = 800\text{ V}, f = 1\text{ MHz}$		36			

Thermal/Package Characteristics

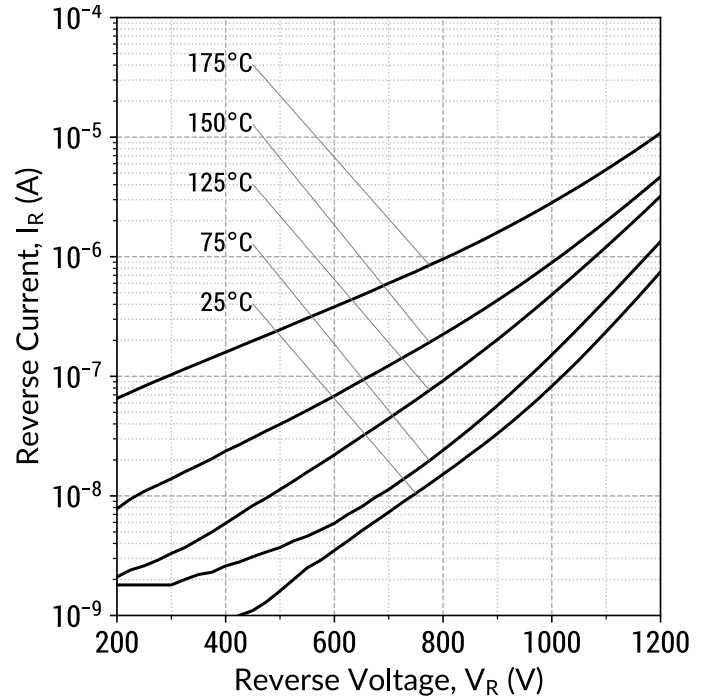
Parameter	Symbol	Conditions	Values			Unit	Note
			Min.	Typ.	Max.		
Thermal Resistance, Junction - Case (Per Leg)	R_{thJC}			0.91		$^\circ\text{C}/\text{W}$	Fig. 9
Weight	W_T			6.1		g	
Mounting Torque	T_M	Screws to Heatsink			1.1	Nm	

Figure 1: Typical Forward Characteristics (Per Leg)



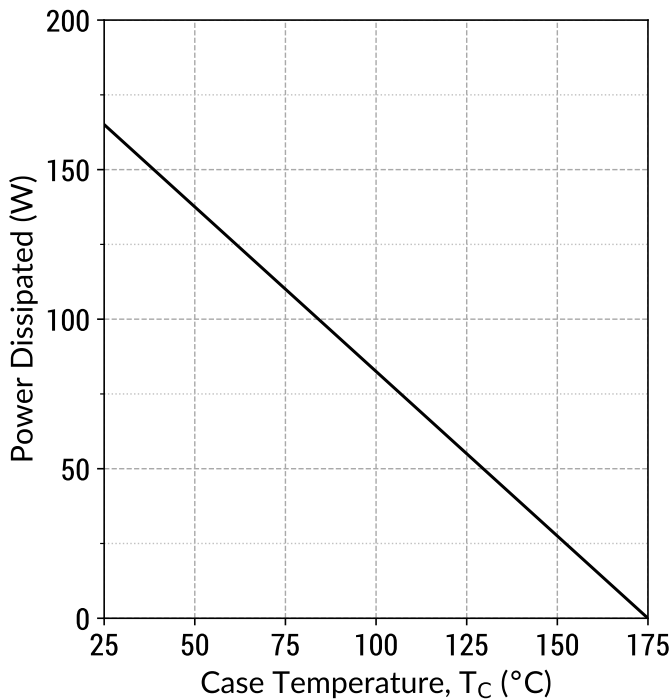
$$I_F = f(V_F, T_j); t_P = 250 \mu s$$

Figure 2: Typical Reverse Characteristics (Per Leg)



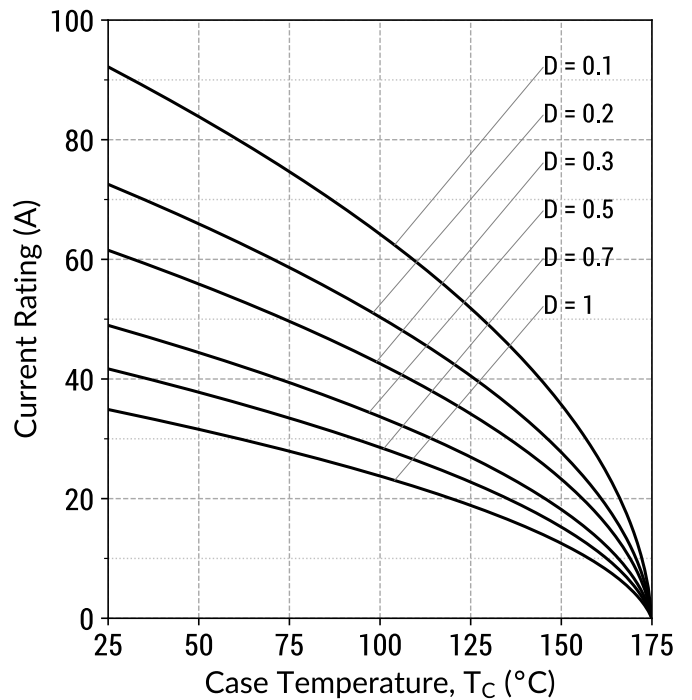
$$I_R = f(V_R, T_j)$$

Figure 3: Power Derating Curves (Per Leg)



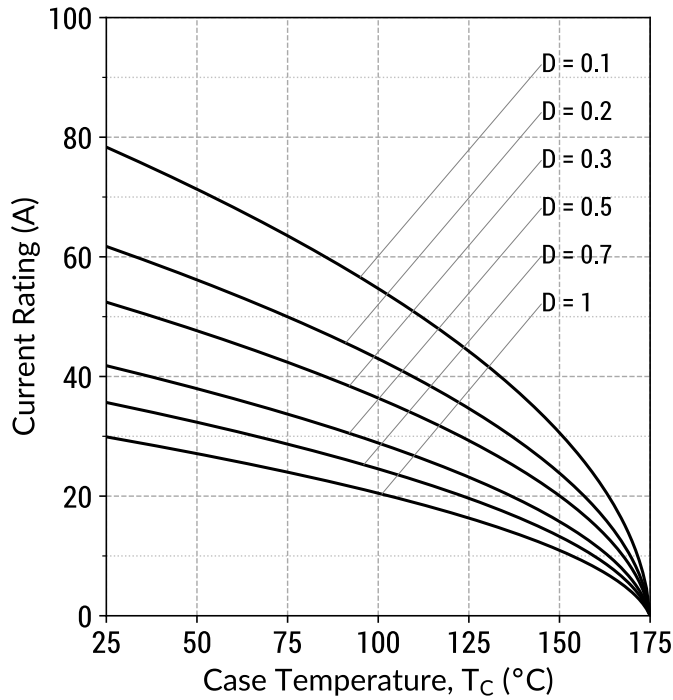
$$P_{TOT} = f(T_C); T_j = 175^\circ C$$

Figure 4: Current Derating Curves (Typical V_F) (Per Leg)



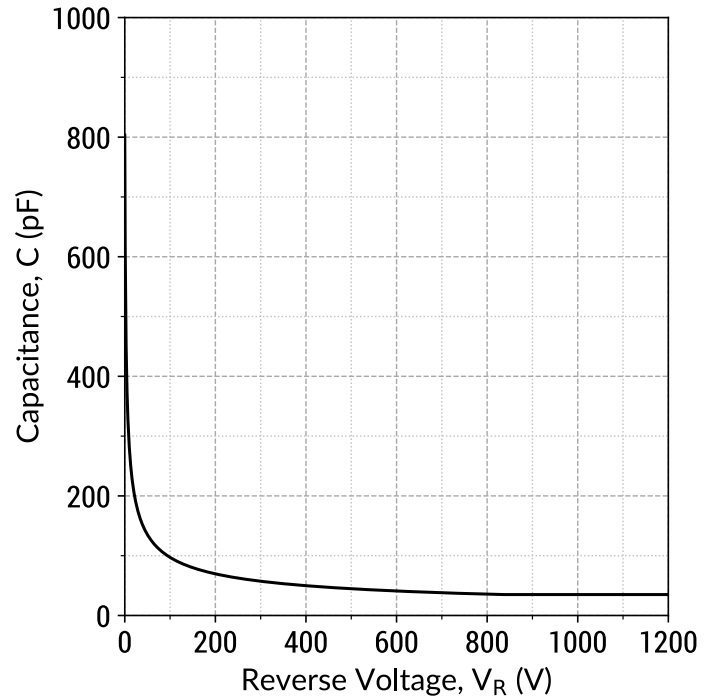
$$I_F = f(T_C); D = t_P/T; T_j \leq 175^\circ C; f_{sw} > 10 kHz$$

Figure 5: Current Derating Curves (Maximum V_F) (Per Leg)



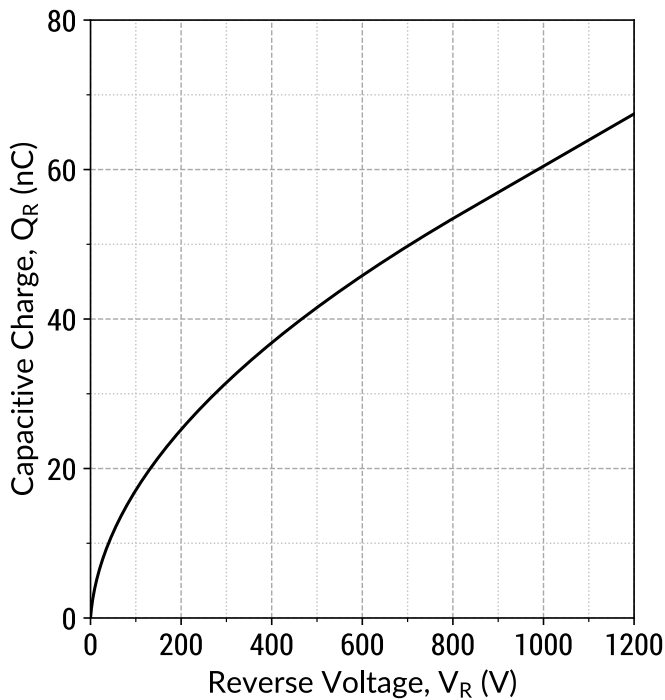
$I_F = f(T_C)$; $D = t_P/T$; $T_J \leq 175^\circ\text{C}$; $f_{SW} > 10\text{kHz}$

Figure 6: Typical Junction Capacitance vs Reverse Voltage Characteristics (Per Leg)



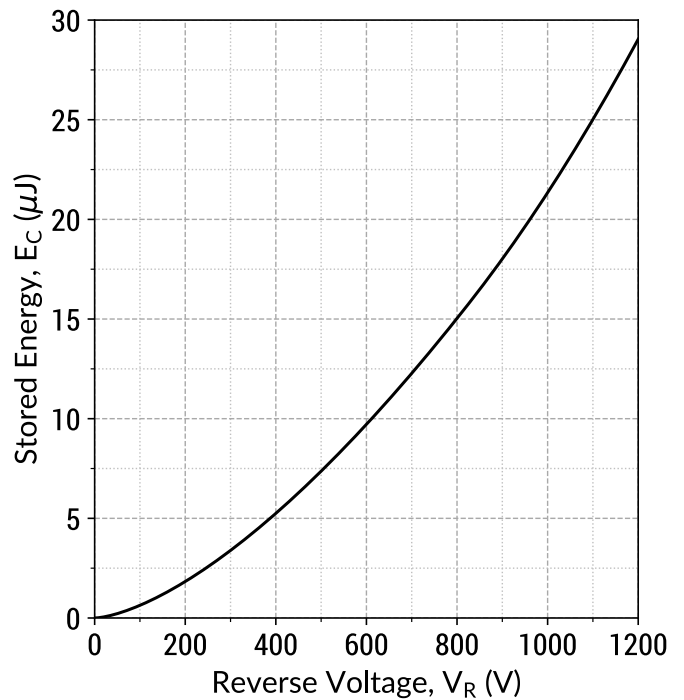
$C = f(V_R)$; $f = 1\text{MHz}$

Figure 7: Typical Capacitive Charge vs Reverse Voltage Characteristics (Per Leg)



$Q_C = f(V_R)$; $f = 1\text{MHz}$

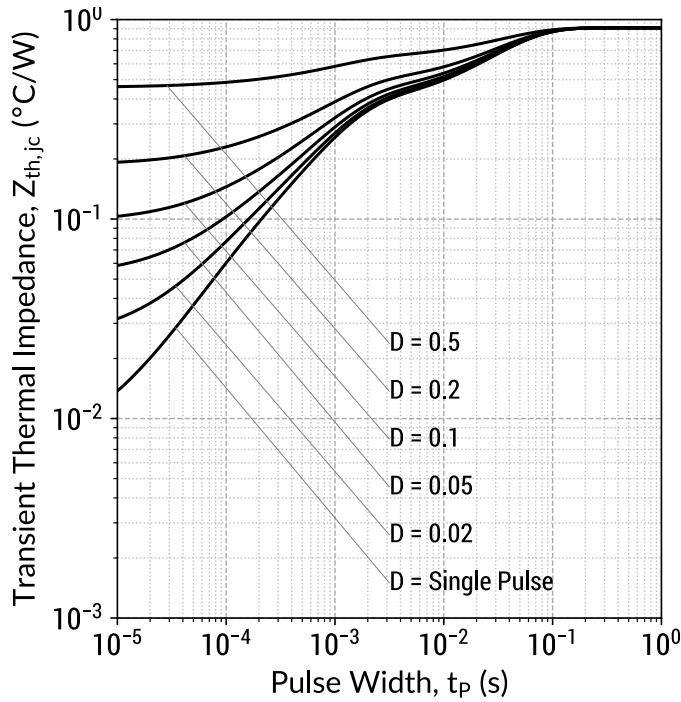
Figure 8: Typical Capacitive Energy vs Reverse Voltage Characteristics (Per Leg)



$E_C = f(V_R)$; $f = 1\text{MHz}$

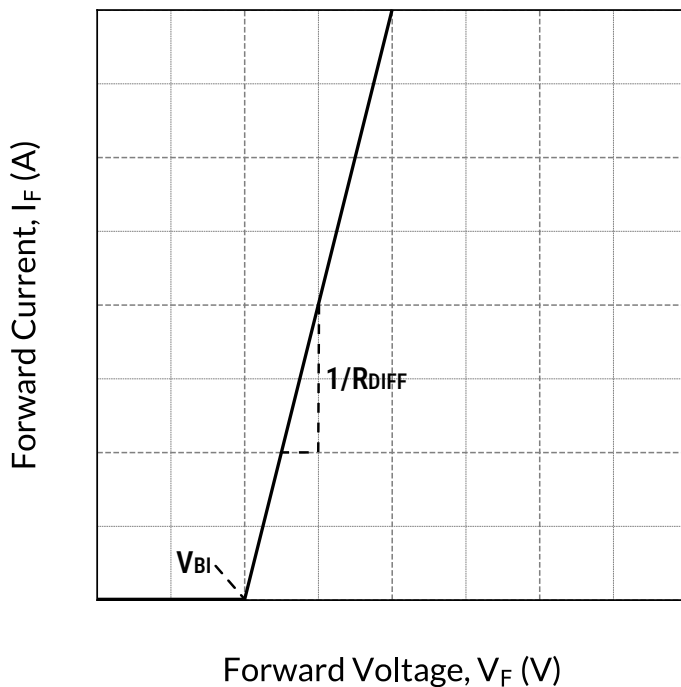


Figure 9: Transient Thermal Impedance (Per Leg)



$$Z_{th,jc} = f(t_p, D); D = t_p/T$$

Figure 10: Forward Curve Model (Per Leg)



$$I_F = f(V_F, T_j)$$

Forward Curve Model Equation:

$$I_F = (V_F - V_{BI})/R_{DIFF} \text{ (A)}$$

Built-In Voltage (V_{BI}):

$$V_{BI}(T_j) = m \times T_j + n \text{ (V)}$$

$$m = -0.00123 \text{ (V/°C)}$$

$$n = 0.995 \text{ (V)}$$

Differential Resistance (R_{DIFF}):

$$R_{DIFF}(T_j) = a \times T_j^2 + b \times T_j + c \text{ (}\Omega\text{)}$$

$$a = 1.19e-06 \text{ (}\Omega\text{/°C}^2\text{)}$$

$$b = 0.000169 \text{ (}\Omega\text{/°C)}$$

$$c = 0.0502 \text{ (}\Omega\text{)}$$

Forward Power Loss Equation:

$$P_{LOSS} = V_{BI}(T_j) \times I_{AVG} + R_{DIFF}(T_j) \times I_{RMS}^2$$



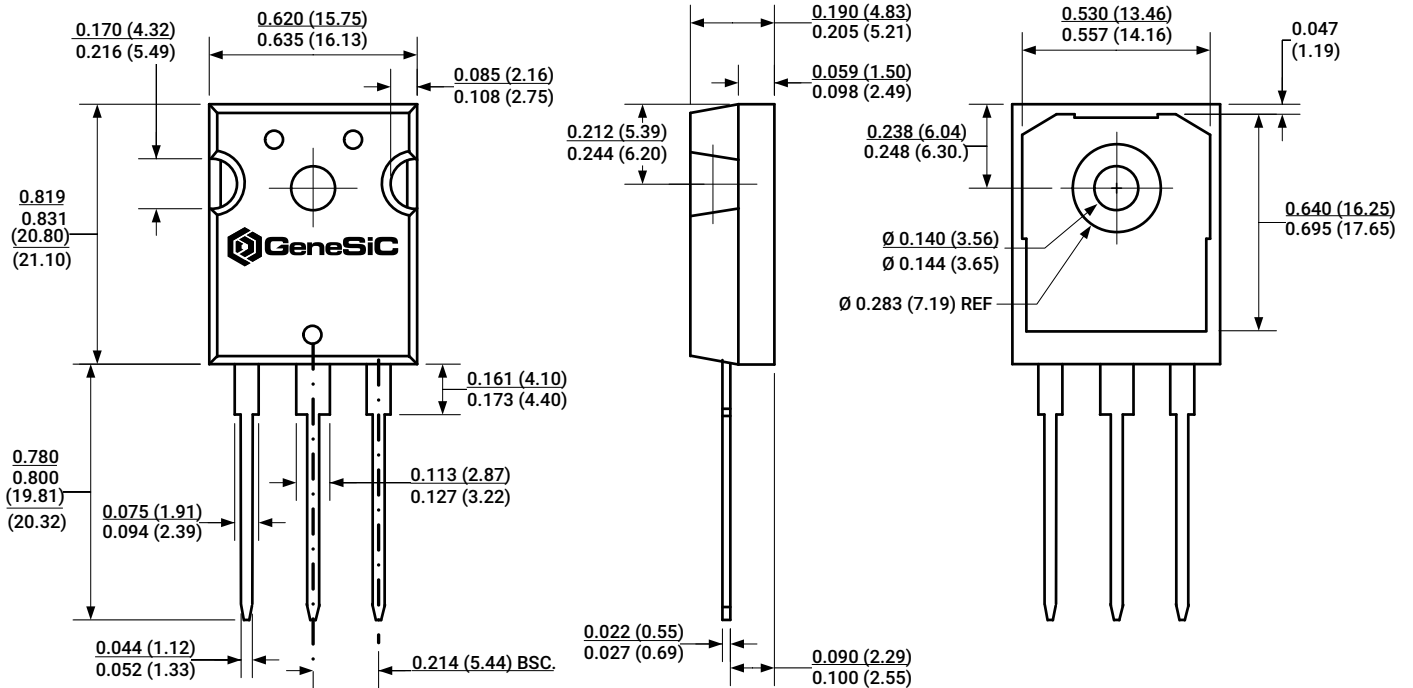
GC2X10MPS12-247

1200V 20A SiC Schottky MPS™ Diode

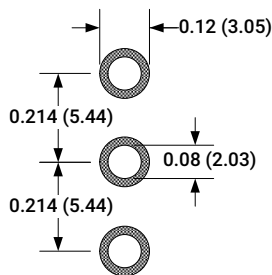


Package Dimensions

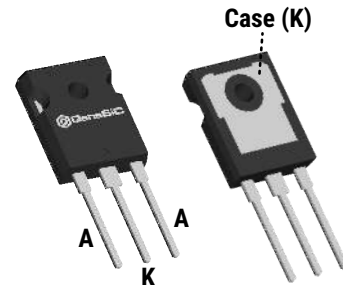
TO-247-3 Package Outline



Recommended Solder Pad Layout



Package View



NOTE

1. CONTROLLED DIMENSION IS INCH. DIMENSION IN BRACKET IS MILLIMETER.
2. DIMENSIONS DO NOT INCLUDE END FLASH, MOLD FLASH, MATERIAL PROTRUSIONS.



Compliance

RoHS Compliance

The levels of RoHS restricted materials in this product are below the maximum concentration values (also referred to as the threshold limits) permitted for such substances, or are used in an exempted application, in accordance with EU Directive 2011/65/EC (RoHS 2), as adopted by EU member states on January 2, 2013 and amended on March 31, 2015 by EU Directive 2015/863. RoHS Declarations for this product can be obtained from your GeneSiC representative.

REACH Compliance

REACH substances of high concern (SVHCs) information is available for this product. Since the European Chemical Agency (ECHA) has published notice of their intent to frequently revise the SVHC listing for the foreseeable future, please contact a GeneSiC representative to insure you get the most up-to-date REACH SVHC Declaration. REACH banned substance information (REACH Article 67) is also available upon request.

Disclaimer

GeneSiC Semiconductor, Inc. reserves right to make changes to the product specifications and data in this document without notice. GeneSiC disclaims all and any warranty and liability arising out of use or application of any product. No license, express or implied to any intellectual property rights is granted by this document.

Unless otherwise expressly indicated, GeneSiC products are not designed, tested or authorized for use in life-saving, medical, aircraft navigation, communication, air traffic control and weapons systems, nor in applications where their failure may result in death, personal injury and/or property damage.

Related Links

- SPICE Models: https://www.genesicsemi.com/sic-schottky-mps/GC2X10MPS12-247/GC2X10MPS12-247_SPICE.zip
- PLECS Models: https://www.genesicsemi.com/sic-schottky-mps/GC2X10MPS12-247/GC2X10MPS12-247_PLECS.zip
- CAD Models: https://www.genesicsemi.com/sic-schottky-mps/GC2X10MPS12-247/GC2X10MPS12-247_3D.zip
- Evaluation Boards: <https://www.genesicsemi.com/technical-support>
- Reliability: <https://www.genesicsemi.com/reliability>
- Compliance: <https://www.genesicsemi.com/compliance>
- Quality Manual: <https://www.genesicsemi.com/quality>

Revision History

- Rev 21/Jul: Updated with most recent test data
- Supersedes: Rev 19/Apr, Rev 20/Apr, Rev 20/Aug



www.genesicsemi.com/sic-schottky-mps/