

22 W auxiliary power supply for indoor air-conditioner using ICE5BR2280BZ

REF_5BR2280BZ_22W1

About this document

Scope and purpose

This document is a reference design for a 22 W auxiliary power supply for a residential air-conditioner unit with the latest fifth-generation Infineon fixed-frequency (FF) CoolSET™ ICE5BR2280BZ. The power supply is designed with a universal input compatible with most geographic regions and three outputs (+12 V/1.4 A isolated, +5 V/0.3 A isolated, +15 V/150 mA non-isolated).

Highlights of the auxiliary power supply for indoor air-conditioner unit are:

- Tightly regulated output voltages, high efficiency under light load and low standby power
- Comprehensive protection for a robust system
- Auto-restart protection scheme to minimize interruption and enhance end-user experience

Intended audience

This document is intended for power supply design engineers who are designing auxiliary power supplies for residential air-conditioner units that are efficient, reliable and easy to design.

Table of contents

About this document	1
Table of contents	1
1 System introduction	3
2 Reference board design	5
3 Power supply specifications	6
4 Circuit diagram	7
5 Circuit description	8
5.1 EMI filtering and line rectification.....	8
5.2 Flyback converter power stage.....	8
5.3 Control of flyback converter through fifth-generation FF CoolSET™ ICE5BR2280BZ.....	8
5.3.1 Current sensing	8
5.3.2 Feedback and compensation network.....	8
5.4 Unique features of the fifth-generation FF CoolSET™ ICE5BR2280BZ	9
5.4.1 Fast self-start-up and sustaining of V_{CC}	9
5.4.2 CCM, DCM operation with frequency reduction.....	9
5.4.3 Frequency jittering with modulated gate drive	9
5.4.4 System robustness and reliability through protection features	10
5.5 Clamper circuit	10
5.6 PCB design tips.....	10
5.7 EMI reduction tips	11
6 PCB layout	12

Table of contents

6.1	Top side	12
6.2	Bottom side	12
7	Bill of materials.....	13
8	Transformer specification	15
9	Measurement data and graphs.....	16
9.1	Efficiency curve.....	18
9.2	Standby power	19
9.3	Line and load regulation	19
9.4	Maximum input power	20
9.5	ESD immunity (EN 61000-4-2).....	20
9.6	Surge immunity (EN 61000-4-5)	20
9.7	Conducted emissions (EN 55022 class B)	21
9.8	Thermal measurement	21
9.9	+18 V rail regulation (LDO input).....	23
10	Waveforms and oscilloscope plots.....	24
10.1	Start-up at full load	24
10.2	Soft-start at full load	24
10.3	Drain and CS voltage at full load	25
10.4	Frequency jittering.....	25
10.5	Load-transient response	26
10.6	Output ripple voltage at full load	26
10.7	Output ripple voltage at ABM.....	27
10.8	Entering ABM	27
10.9	During ABM	28
10.10	Leaving ABM	28
10.11	V _{CC} OV/UV protection	29
10.12	Overload protection	29
11	Appendix A: Transformer design and spreadsheet [3]	30
12	Appendix B: WE transformer specification	39
13	References	40
	Revision history.....	41

System introduction

1 System introduction

With the growing household trend for internet-connected devices, the new generation of home appliances such as air-conditioners are equipped with advanced features such as wireless control and monitoring capability, smart sensors and touch screen display. These can transform a static product into an interactive and intelligent home appliance, capable of adapting to the smart-home theme. Infineon has introduced the latest fifth-generation FF CoolSET™ to address this need in an efficient and cost-effective manner.

An auxiliary SMPS is needed to power the various modules and sensors, which typically operate from a stable DC voltage source. The Infineon CoolSET™ (as shown in Figure 1) forms the heart of the system, providing the necessary protection and AC-DC conversion from the mains to multiple regulated DC voltages to power the various blocks.

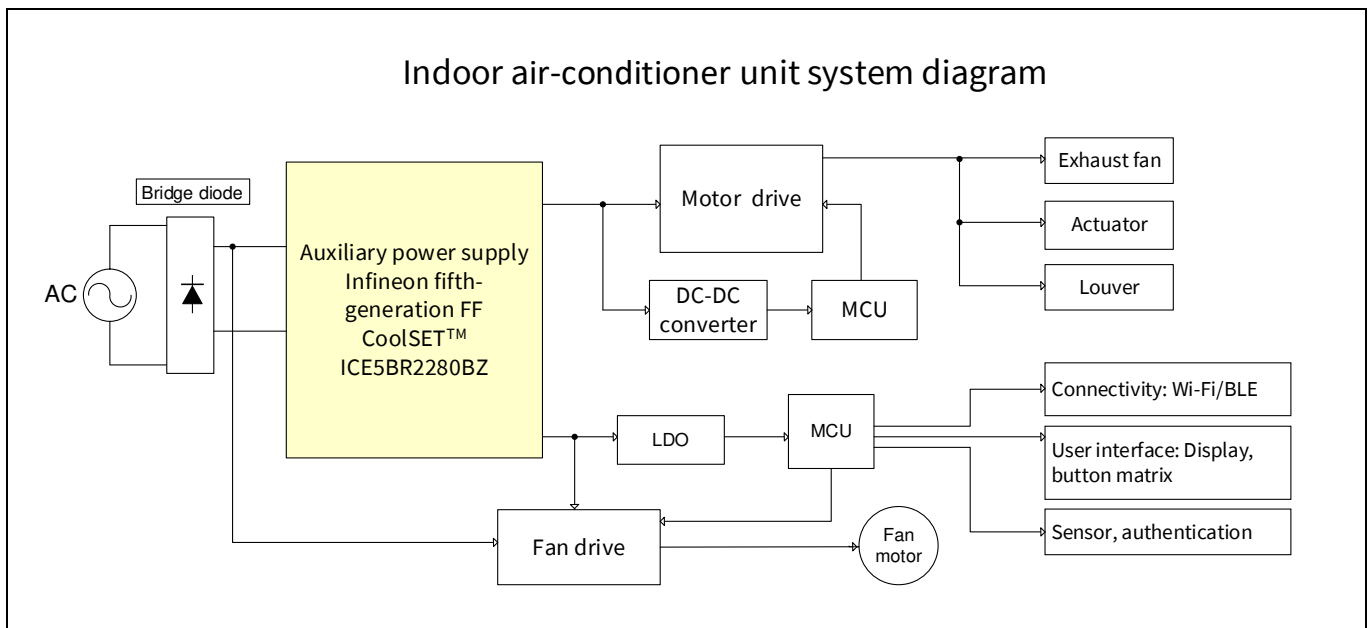

Figure 1 Simplified indoor air-conditioner system diagram

Table 1 lists the system requirements for auxiliary power supply for an indoor air-conditioner unit, and the corresponding Infineon solution is shown in the right-hand column.

Table 1 System requirements and Infineon solutions

	System requirement for indoor air-conditioner unit power supply	Infineon solution – ICE5BR2280BZ
1	High efficiency under light load and low standby power	Digital frequency reduction and active burst mode (ABM)
2	Robust system and protection features	Comprehensive protection feature CoolSET™ in DIP-7 package
3	Auto-restart protection scheme to minimize interruption to enhance end-user experience	All protections are in auto-restart

1.1 High efficiency under light load and low standby power

During indoor air-conditioner operation, the power requirement fluctuates according to various use cases. However, in most cases where room temperature is already stabilized, the indoor and outdoor air-conditioner units will reside in an idle state, in which the loading toward the auxiliary power supply is low. It is crucial that

System introduction

the auxiliary power supply operates as efficiently as possible, because it will be in this particular state for most of the period. Under light-load conditions, losses incurred with the power switch are usually dominated by the switching operation. The choice of switching scheme and frequency play a crucial role in ensuring high conversion efficiency.

In this reference design, ICE5BR2280BZ was primarily chosen due to its frequency reduction switching scheme. Compared with a traditional FF flyback, the CoolSET™ reduces its switching frequency from medium to light load, thereby minimizing switching losses. Therefore, an efficiency of more than 80 percent is achievable under 25 percent loading conditions and nominal input voltages.

1.2 Simplified circuitry with good integration of power and protection features

To relieve the designer of the complexity of PCB layout and circuit design, CoolSET™ is a highly integrated device with both a controller and a HV MOSFET integrated into a single, space-saving DIP-7 package. These certainly help the designer to reduce component count as well as simplifying the layout into a simple PCB design for ease of manufacturing, using the traditional cost-effective wave-soldering process.

1.3 Auto-restart protection scheme to minimize interruption to enhance end-user experience

For a residential air-conditioner unit, it would be annoying to both the end user and the manufacturer if the system were to halt and latch after protection. Accessibility of the input AC plug may also be difficult; therefore, to minimize interruption, the CoolSET™ implements auto-restart mode for all abnormal protections.

2 Reference board design

This document provides complete design details including specifications, schematics, bill of materials (BOM), PCB layout and transformer design. Performance results pertaining to line/load regulation, efficiency, transient load, thermal conditions, conducted EMI scans and so on are also included.

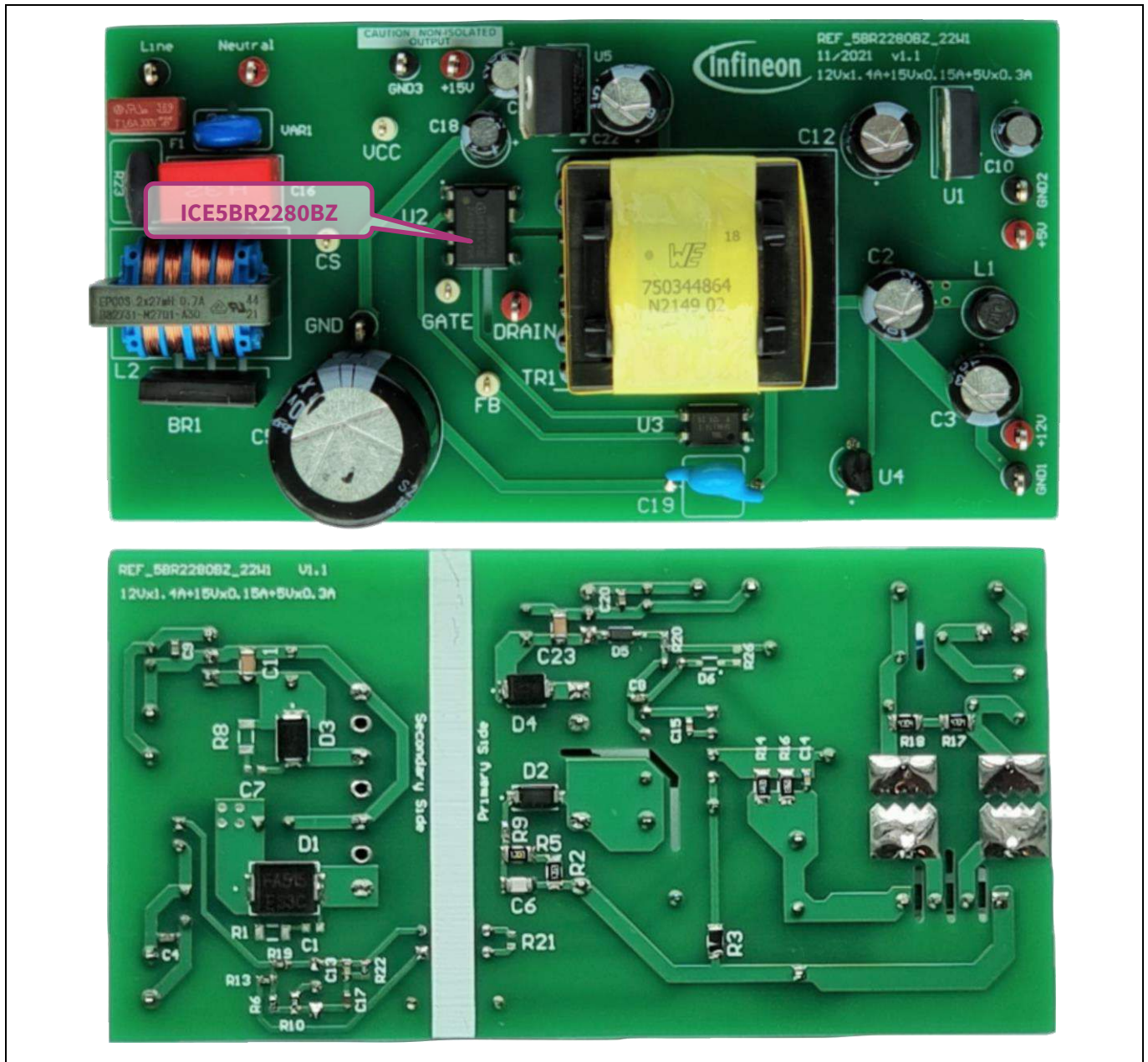

Figure 2 REF_5BR2280BZ_22W1

Power supply specifications

3 Power supply specifications

The table below shows the minimum acceptable performance of the design at 25°C ambient temperature. Actual performance is listed in the measurements section.

Table 2 Specifications of REF_5BR2280BZ_22W1

Description	Symbol	Min.	Typ.	Max.	Units	Comments
Input						
Voltage	V_{IN}	85	-	264	V AC	2 wires (no P.E.)
Frequency	f_{LINE}	47	50/60	64	Hz	
No-load input power	P_{stby_NL}	-	-	120	mW	
Output						
Output voltage 1	V_{O1}	-	12	-	V	± 1 percent
Output current 1	I_{O1}	-	-	1.4	A	
Output voltage ripple 1	$V_{RIPPLE1}$	-	-	120	mV	
Output voltage 2	V_{O2}	-	5	-	V	± 1 percent
Output current 2	I_{O2}	5	-	300	mA	
Output voltage ripple 2	$V_{RIPPLE2}$	-	-	75	mV	
Output voltage 3	V_{O3}	-	15	-	V	± 1 percent
Output current 3	I_{O3}	5	-	150	mA	
Output voltage ripple 3	$V_{RIPPLE3}$	-	-	100	mV	
Output power	P_{OUT_Nom}	-	19.75	-	W	0.15 A load on 15 V and 0.5 A load on 5 V load
Overcurrent protection (+12 V)	I_{OCP}	-	1.5	-	A	
Start-up time	t_{start_up}	-	-	250	ms	
Efficiency						
Maximum load	η	75	-	-	%	115 V AC/230 V AC
Average efficiency	η_{avg}	75	-	-	%	
Maximum load (single output)	η_s	83	-	-	%	
Average efficiency (single output)	η_{avg_s}	83	-	-	%	
Environmental						
Conducted EMI			6		dB	Margin, CISPR 22 class B EN 61000-4-2 EN 61000-4-5
ESD			±6		kV	
Surge immunity						
Differential mode			±2		kV	
Common mode			±4		kV	
PCB dimension			110 x 57		mm ²	L x W

Circuit diagram

4 Circuit diagram

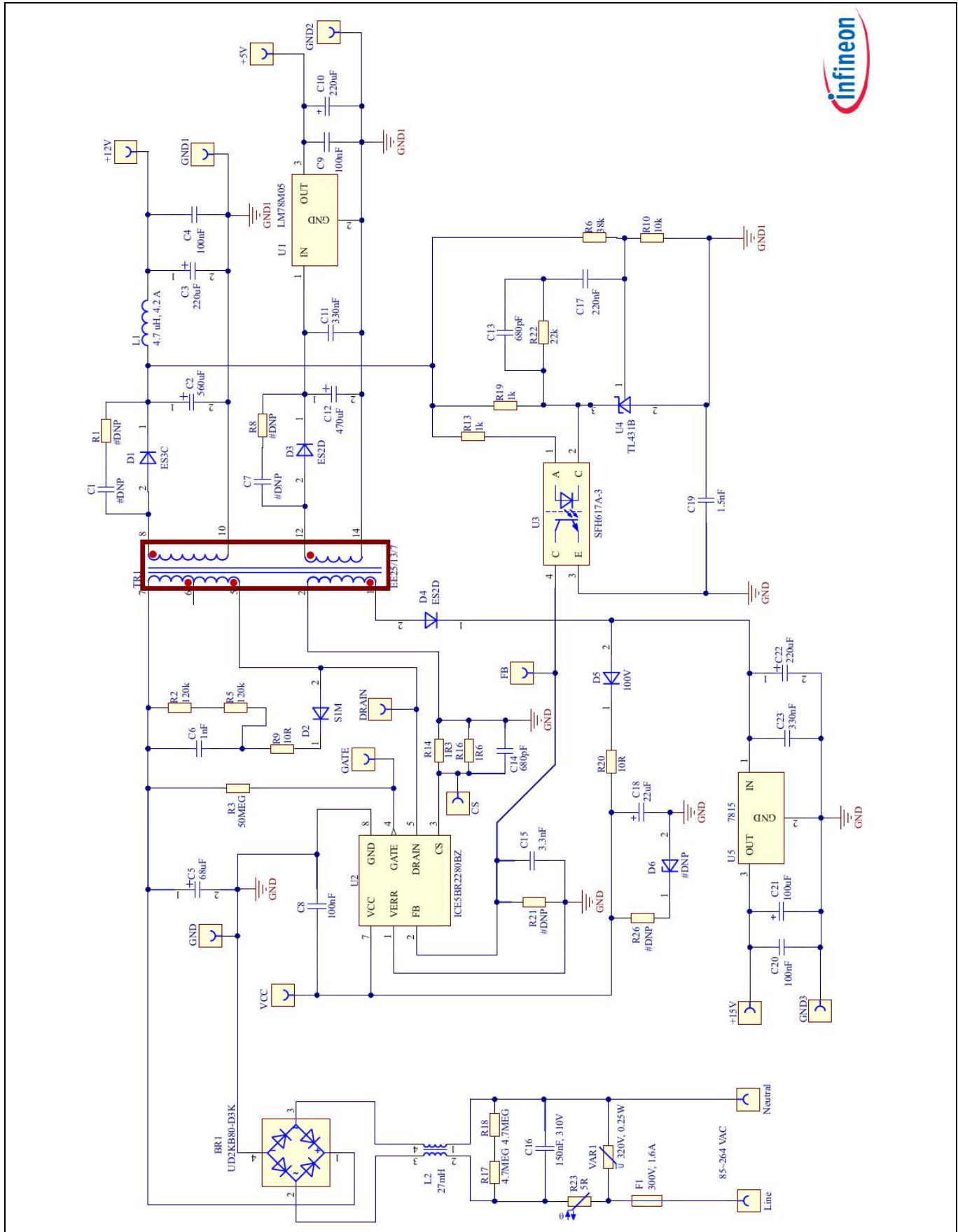

Figure 3 Schematic of REF_5BR2280BZ_22W1

5 Circuit description

In this section, the design circuit for the SMPS unit will be briefly described by the different functional blocks. For details of the design procedure and component selection for the flyback circuitry please refer to the IC design guide [2] and calculation tool [3].

5.1 EMI filtering and line rectification

The input of the power supply unit is taken from the AC power grid, which is in the range of 85 V AC ~ 264 V AC. The fuse F1 is directly connected to the input line to protect the system in case of excess current entering the system circuit due to any fault. Following is the varistor VAR1, which is connected across the input to absorb excess energy during line-surge transient. The X-capacitor C16 and common-mode choke (CMC) L2 reduce the EMI noise. R17 and R18 serve as the X-capacitor discharge resistor. The bridge rectifier BR1 rectifies the AC input into DC voltage, filtered by the bulk capacitor C5.

5.2 Flyback converter power stage

The flyback converter power stage consists of transformer TR1, CoolSET™, secondary rectification diodes D1, D3 and D4, secondary output capacitors C2, C12 and C22 and output filter inductor L1.

When the primary HV MOSFET turns on, energy is stored in the transformer. When it turns off, the stored energy is discharged to the output capacitors and into the output load.

Secondary winding is sandwiched between two layers of primary winding to reduce leakage inductance. This improves efficiency and reduces voltage spikes.

For the output rectification, lower forward voltage and ultra-fast recovery diodes can improve efficiency. Capacitor C2, C12 stores the energy needed during output load jumps. LC filter L1/C3 reduces the high-frequency ripple voltage.

The +15 V output is from the 15 V low dropout (LDO) regulator (U5) with an input of +18 V, which also supplies V_{CC} . The +5 V output is from the 5 V LDO regulator (U1) with an input of +8 V. As such, these two outputs would not be affected by cross-regulation. However, their inputs should be maintained within the operating range of the LDO.

5.3 Control of flyback converter through fifth-generation FF CoolSET™ ICE5BR2280BZ

5.3.1 Current sensing

The ICE5BR2280BZ is a current mode controller. The primary peak current is controlled cycle-by-cycle through the CS resistors R14 and R16 in the CS pin (pin 4). Transformer saturation can be avoided through peak current limitation (PCL); therefore, the system is more protected and reliable.

5.3.2 Feedback and compensation network

Resistor dividers R24 and R27 are used to sense the V_{OUT} and send the reference voltage to the feedback (FB) pin (pin 2) via error amplifier TL431(U4) and optocoupler(U3). A Type II compensation network C13, C17 and R22 is implemented to stabilize the system.

The FB pin of ICE5BR2280BZ is a multifunction pin, which is used to select the entry burst power level (there are three levels available) through the resistor at the FB pin (R21) and also the burst-on/burst-off sense input during ABM.

Circuit description

5.4 Unique features of the fifth-generation FF CoolSET™ ICE5BR2280BZ

5.4.1 Fast self-start-up and sustaining of V_{CC}

The IC uses a cascode structure to fast-charge the V_{CC} capacitor. Pull-up resistors R3, R6 and R10 connected to the GATE pin (pin 4) are used to initiate the start-up phase. At first, I_{VCC_Charge1} is used to charge the V_{CC} capacitor from 0 V to V_{VCC_SCP}. This is a protection which reduces the power dissipation of the power MOSFET during V_{CC} short-to-GND condition. Thereafter, a much higher charging current of I_{VCC_Charge2} will charge the V_{CC} capacitor until the V_{CC_ON} is reached.

After start-up, the IC V_{CC} supply is usually sustained by the auxiliary winding of the transformer, which needs to support the V_{CC} to be above undervoltage lockout (UVLO) voltage (10 V typ.). In this reference board, the V_{CC} supply is tapped from the +18 V winding.

5.4.2 CCM, DCM operation with frequency reduction

ICE5BR2280BZ can be operated in either discontinuous conduction mode (DCM) or continuous conduction mode (CCM) with frequency-reduction features. This reference board is designed to operate in DCM at operating input voltage and load conditions. When the system is operating at high output load, the controller will switch at 65 kHz FF. In order to achieve a better efficiency between light load and medium load, frequency reduction is implemented as a function of V_{FB}, as shown in Figure 4. Switching frequency will not reduce further once the minimum switching frequency of 28 kHz is reached.

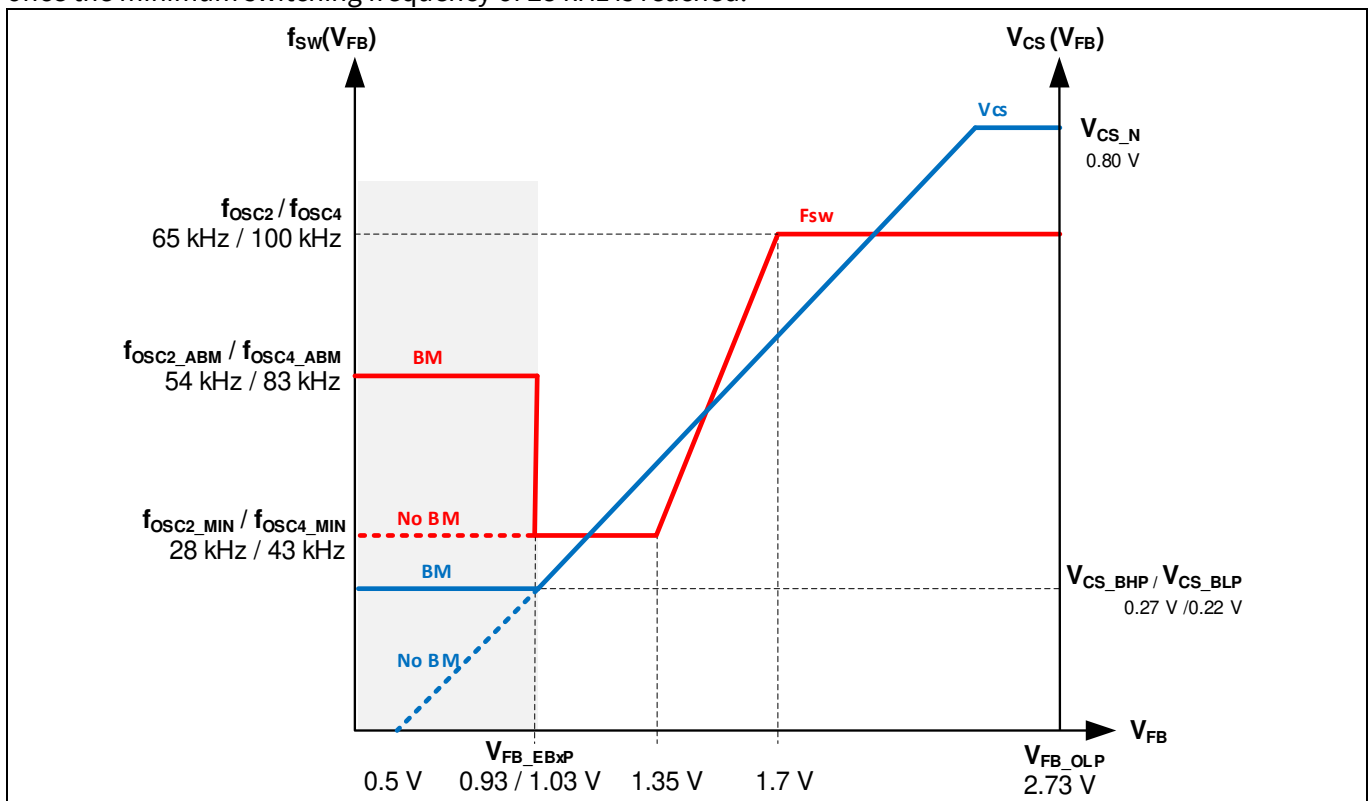

Figure 4 Frequency-reduction curve

5.4.3 Frequency jittering with modulated gate drive

The ICE5BR2280BZ has a frequency jittering feature with modulated gate drive to reduce the EMI noise. The jitter frequency is internally set at ±4 percent of 65 kHz, and the jitter period is 4 ms.

Circuit description

5.4.4 System robustness and reliability through protection features

Protection is one of the major factors in determining whether the system is safe and robust – therefore sufficient protection is necessary. ICE5BR2280BZ provides comprehensive protection to ensure the system is operating safely. This includes V_{CC} overvoltage (OV) and undervoltage (UV), overload, overtemperature and V_{CC} short-to-GND. When those faults are found, the system will enter protection mode. Once the fault is removed, the system resumes normal operation. A list of protections and failure conditions is shown in the table below.

Table 3 Protection functions of ICE5BR2280BZ

Protection function	Failure condition	Protection mode
V_{CC} OV	V_{VCC} greater than V_{VCC_OVP}	Odd-skip auto-restart
V_{CC} UV	V_{VCC} less than V_{VCCoff}	Auto-restart
Overload	V_{FB} greater than V_{FB_OLP} and lasts for $t_{FB_OLP_B}$	Odd-skip auto-restart
Overtemperature	T_J greater than T_{jcon_OTP} (T_{jhys_OTP} hysteresis)	Non-switch auto-restart
V_{CC} short-to-GND ($V_{VCC} = 0\text{ V}$, start-up = 50 mΩ and $V_{DRAIN} = 90\text{ V}$)	V_{VCC} less than V_{VCC_SCP} , $I_{VCC_Charge1} \approx -0.2\text{ mA}$ (typ.)	No start-up

5.5 Clamper circuit

A clamper network (D2, C6, R2, R5, R9) is used to reduce the switching voltage spikes across the DRAIN pin of the integrated HV MOSFET of the CoolSET™, which are generated by the leakage inductance of the transformer TR1. This is a dissipative circuit; therefore, R2 and R5 and C6 need to be fine-tuned depending on the voltage derating factor and efficiency requirement.

5.6 PCB design tips

For a good PCB design layout, there are several points to note.

- The switching power loop needs to be as small as possible (see Figure 5). There are four power loops in the reference design; one on the HV side and three on the output side. The HV side loop starts from the bulk capacitor (C5) positive terminal, primary transformer winding (pin 7 and pin 5 of TR1), CoolSET™, CS resistors and back to the C5 negative terminal. The first output side loop (12 V output) starts at the transformer winding (pin 8 of TR1), output diode D1, output capacitor C2 and back to pin 10 of TR1. The second output side loop (8 V output) starts at the transformer winding (pin 12 of TR1), output diode D3, output capacitor C12 and back to pin 14 of TR1. The third output side loop (18 V output) starts at the transformer winding (pin 1 of TR1), output diode D4, output capacitor C18 and back to pin 2 of TR1.

Circuit description

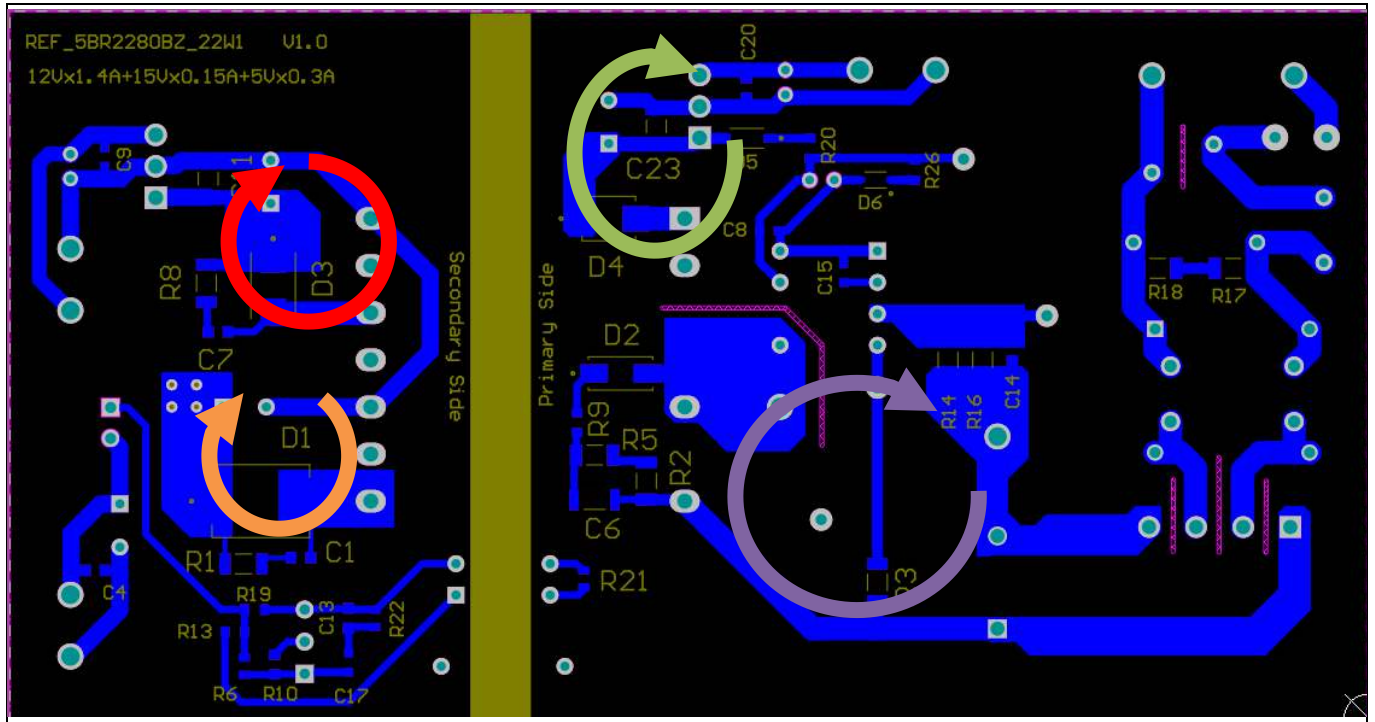

Figure 5 PCB layout tips

- Star-ground connection should be used to reduce high-frequency (HF) noise coupling that can affect the functional operation. The ground of the small-signal components should connect directly to the IC ground (pin 8 of U2).
- Separating the HV components and LV components, e.g., clamper circuit, main switching circuit; this can help to reduce spark-over chance of the high energy surge during a lightning surge test.
- The PCB copper pour on the DRAIN pin of the MOSFET can act as a heatsink, thus it can be widened if necessary.

5.7 EMI reduction tips

EMI compliance is always a challenge for the power supply designer. There are several critical points to consider in order to achieve a satisfactory EMI performance.

- A proper transformer design can significantly reduce EMI. Low leakage inductance can incur a low switching spike and HF noise. Interlaced winding technique is the most common practice to reduce leakage inductance. Winding shield, core shield and whole transformer shield are also some of the techniques used to reduce EMI.
- Input CMC and X-capacitor greatly reduce EMI, but this is costly and impractical especially for low-power applications.
- Short-switching power-loop design in the PCB (as described in section 5.6) can reduce radiated EMI due to the antenna effect.
- An output diode snubber circuit can reduce HF noise.
- Ferrite beads can reduce HF noise, especially on critical nodes such as the DRAIN pin, clamper diode and output diode terminals. There is no ferrite bead used in this design, as this can reduce the efficiency due to additional losses, especially on high-current terminals.

PCB layout

6 PCB layout

6.1 Top side

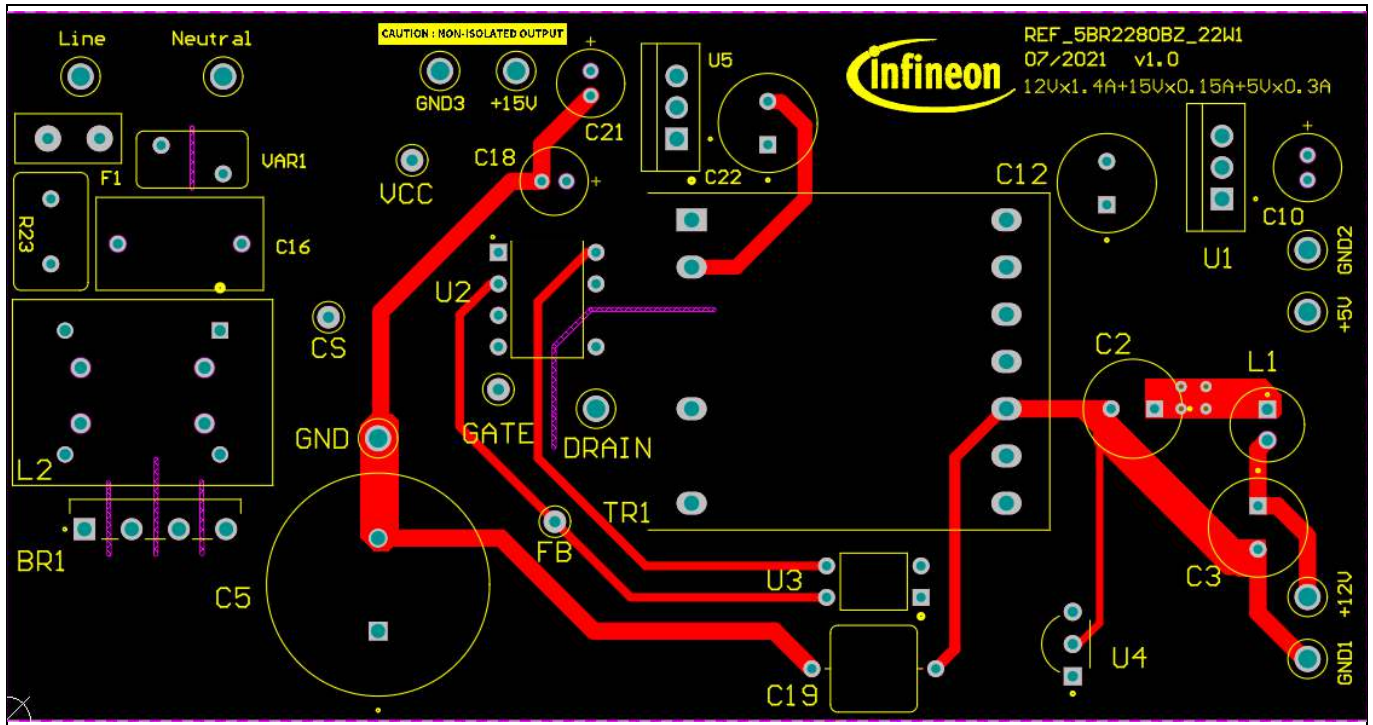

Figure 6 Top-side copper and component legend

6.2 Bottom side

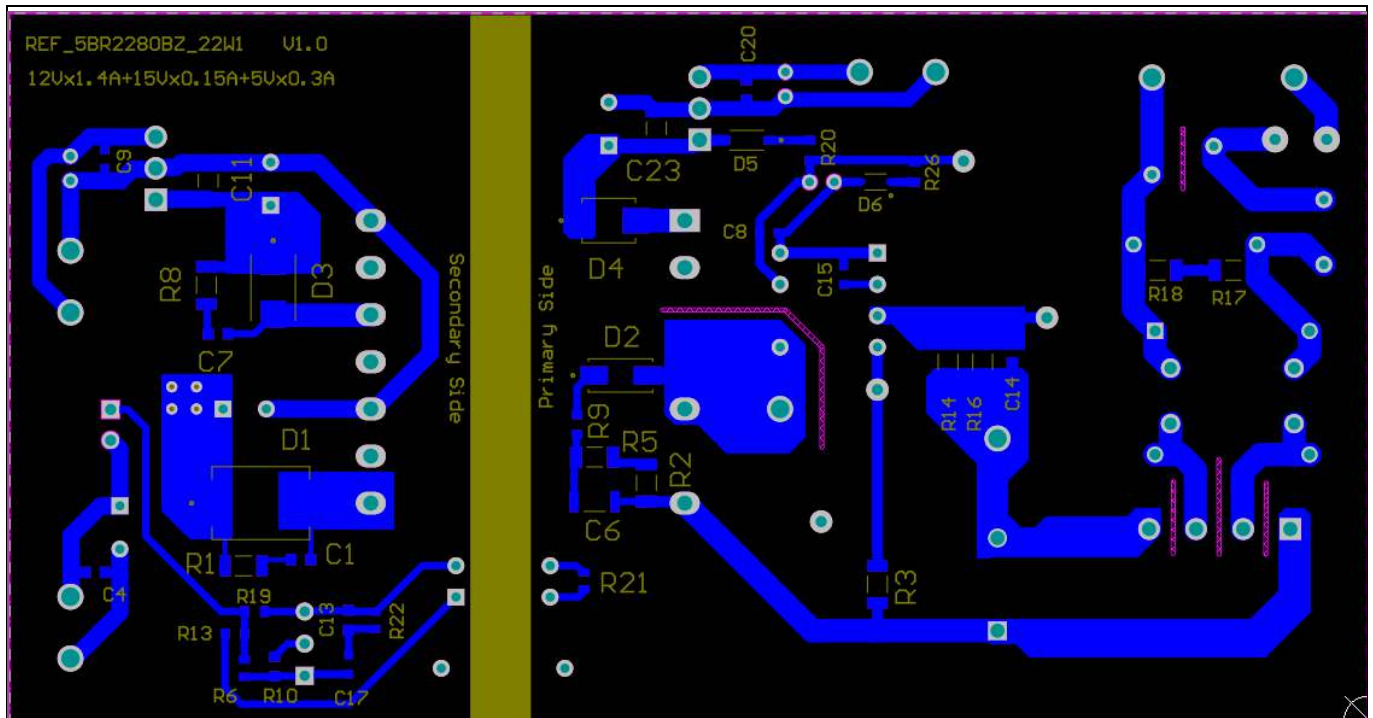

Figure 7 Bottom-side copper and component legend

22 W auxiliary power supply for indoor air-conditioner using ICE5BR2280BZ



Bill of materials

7 Bill of materials

Table 4 BOM

No.	Designator	Description	Manufacturer	Part number	Quantity
1	BR1	Bridge diode 800 V 2 A		UD2KB80-7000	1
2	C2	Aluminum capacitor 560 μ F 20% 25 V radial	Rubycon	25ZLJ560M8X20	1
3	C3, C22	Aluminum capacitor 220 μ F 20% 35 V radial	Rubycon	35ZLH220MEFCT78X11.5	2
4	C4, C8, C9, C20	Ceramic capacitor 0.1 μ F 50 V X7R 0603			4
5	C5	Aluminum capacitor 68 μ F 20% 400 V radial	Rubycon	400BXW68MEFC18X20	1
6	C6	Ceramic capacitor 1206 1 nF 500 V X7R 10% FL			1
7	C10, C21	Aluminum capacitor 100 μ F 20% 25 V radial	Rubycon	25PX100MEFC5X11	2
8	C11, C23	Ceramic capacitor 0.33 μ F 50 V X7R 1206			2
9	C12	Aluminum capacitor 470 μ F 20% 16 V T/H	Rubycon	16ZLJ470M8X11.5	1
10	C13, C14	Ceramic capacitor 0603 680 pF 50 V X7R 10%			2
11	C15	Ceramic capacitor 0603 3.3 nF 50 V X7R 10%			1
12	C16	Film capacitor 0.15 μ F 10% 310 V AC radial	Würth Elektronik	890334023025	1
13	C17	Ceramic capacitor 0.22 μ F 50 V X7R 0603			1
14	C18	Aluminum capacitor 22 μ F 20% 35 V radial	UVR1V220MDD	Nichicon	1
15	C19	Ceramic capacitor 1500 pF 250 V radial	Murata	DE1E3KX152MA4BN01F	1
16	D1	General-purpose diode 150 V 3 A SMC		ES3C	1
17	D2	General-purpose diode 1 kV 1 A SMA		S1M	1
18	D3, D4	General-purpose diode 200 V 2 A DO214AA		ES2C	2
19	D5	General-purpose diode 100 V 150 mA SOD-123	Diodes Incorporated	BAV16W-7-F	1
20	F1	Time-lag fuse 300 V 1.6 A	Littelfuse	36911600000	1
21	L1	Inductor WE-TI size 5075 4.7 μ H, 4.2 A	Würth Elektronik	7447462047	1
22	L2	CMC 27 mH 700 mA 2LN TH	TDK	B82731M2701A030	1
23	R2, R5	SMD resistor 120 k Ω 1% 1/4 W 1206			2
24	R3	SMD resistor 50 m Ω 1% 1206		CRHA1206AF50M0FKEF	3
25	R6	RES 38 k Ω 1% 1/10 W 0603			1
26	R9, R20	SMD resistor 10 Ω 1% 1/10 W 0603			2
27	R10	Resistor 10 k Ω 1% 1/10 W 0603			1
28	R14	SMD resistor 1.3 Ω 1% 1/4 W 1206			1
29	R16	SMD resistor 1.6 Ω 1% 1/4 W 1206			1
30	R13, R19	SMD resistor 1 k Ω 1% 1/8 W 0603			2
31	R17, R18	SMD resistor 4.7 m Ω 1% 1/4 W 1206			2
32	R22	Resistor 22 k Ω 1% 1/10 W 0603			1
33	R23	ICL 5 Ω 20% 4.2 A 9.5 mm	TDK	B57235S0509M000	1
34	TR1	EE25/13/7	Würth Elektronik	750344864	1
35	U1	L7805		L7805ABV	1
36	U2	FF 800 V CoolSET™	Infineon	ICE5BR2280BZ	1
37	U3	Optocoupler 5300 V _{RMS}		SFH617A-3	1
38	U4	IC V _{REF} shunt 36 V 0.4% TO92-3		TL431BVLPG	1

22 W auxiliary power supply for indoor air-conditioner using ICE5BR2280BZ



Bill of materials

39	U5	L7815		L7815ABV	1
40	VAR1	S07K320E2 320 V AC 10%	Epcos	B72207S2321K101	1
41	+15 V, +5 V, +12 V, DRAIN, neutral	Test point THT, red	Keystone	5010	5
42	CS, FB, GATE, V _{CC}	Test point THT, white	Keystone	5002	4
43	GND, GND1, GND2, line	Test point THT, black	Keystone	5011	4

22 W auxiliary power supply for indoor air-conditioner using ICE5BR2280BZ



Transformer specification

8 Transformer specification

Refer to Appendix A for transformer design and Appendix B for WE transformer specification.

Core name and material: EE25/13/7, TP4A (TDG)

Primary inductance: $L_p = 630 \mu\text{H}$ (± 10 percent), measured between pin 5 and pin 7

Manufacturer and part number: Würth Elektronik Midcom (750344864) Rev. 01

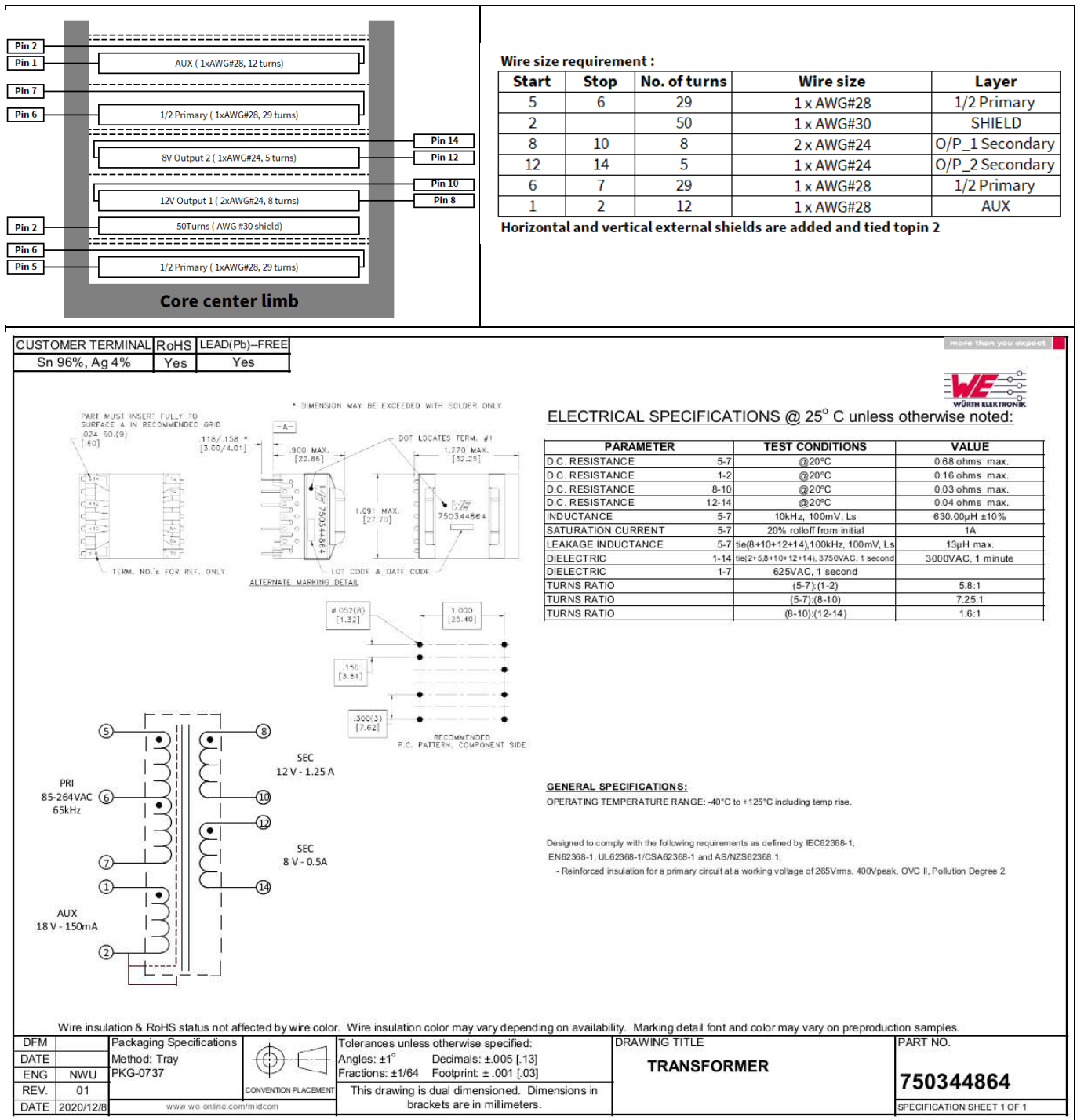

Figure 8 Transformer structure

9 Measurement data and graphs

Table 5 Electrical measurements

Input (V AC/Hz)	P _{IN} (W)	V _{O1} (V)	I _{O1} (A)	V _{O2} (V)	I _{O2} (A)	V _{O3} (V)	I _{O3} (A)	P _{OUT} (W)	Efficiency (%)	Average efficiency (%)	OLP P _{IN} (W)	OLP I _{O1} (A) 5 V/0.3 A 15 V/0.15 A
85 V AC/ 60 Hz	0.289	11.997	0.00	5.067	0.005	15.109	0.005	/	/	/	32.94	1.82
	6.539	11.990	0.35	5.062	0.075	15.078	0.038	5.14	78.63%	78.14%		
	13.076	11.977	0.70	5.060	0.150	15.059	0.075	10.27	78.56%			
	19.700	11.970	1.05	5.057	0.226	15.043	0.113	15.40	78.19%			
	26.580	11.962	1.40	5.052	0.300	15.050	0.150	20.52	77.20%			
115 V AC/ 60 Hz	0.291	11.997	0.00	5.067	0.005	15.109	0.005	/	/	/	32.03	1.82
	6.468	11.990	0.35	5.062	0.075	15.078	0.038	5.14	79.49%	79.51%		
	12.882	11.977	0.70	5.060	0.150	15.059	0.075	10.27	79.74%			
	19.346	11.970	1.05	5.057	0.226	15.043	0.113	15.40	79.62%			
	25.920	11.962	1.40	5.052	0.300	15.050	0.150	20.52	79.17%			
230 V AC/ 50 Hz	0.322	11.997	0.00	5.067	0.005	15.109	0.005	/	/	/	31.11	1.81
	6.541	11.990	0.35	5.062	0.075	15.078	0.038	5.14	78.61%	80.03%		
	12.887	11.977	0.70	5.060	0.150	15.059	0.075	10.27	79.71%			
	19.070	11.970	1.05	5.057	0.226	15.043	0.113	15.40	80.77%			
	25.320	11.962	1.40	5.052	0.300	15.050	0.150	20.52	81.04%			
264 V AC/ 50 Hz	0.326	11.997	0.00	5.067	0.005	15.109	0.005	/	/	/	31.57	1.84
	6.638	11.990	0.35	5.062	0.075	15.078	0.038	5.14	77.46%	79.60%		
	12.874	11.977	0.70	5.060	0.150	15.059	0.075	10.27	79.79%			
	19.130	11.970	1.05	5.057	0.226	15.043	0.113	15.40	80.52%			
	25.450	11.962	1.40	5.052	0.300	15.050	0.150	20.52	80.63%			

Minimum load condition: 12 V/0 A, 5 V/5 mA, 15 V/5 mA

25 percent load condition: 12 V/0.35 A, 5 V/75 mA, 15 V/37.5 mA

50 percent load condition: 12 V/0.70 A, 5 V/150 mA, 15 V/75 mA

75 percent load condition: 12 V/1.05 A, 5 V/225 mA, 15 V/112.5 mA

100 percent load condition: 12 V/1.4 A, 5 V/300 mA, 15 V/150 mA

22 W auxiliary power supply for indoor air-conditioner using ICE5BR2280BZ



Measurement data and graphs

Table 6 Single-output electrical measurements

Input (V AC/Hz)	P _{IN} (W)	V _{O1} (V)	I _{O1} (A)	P _{OUT} (W)	Efficiency (%)	Average efficiency (%)
85 V AC/ 60 Hz	0.039	12.000	0.00			82.34%
	5.059	11.990	0.35	4.20	82.95%	
	10.115	11.980	0.70	8.39	82.91%	
	15.320	11.970	1.05	12.57	82.04%	
	20.550	11.960	1.40	16.74	81.48%	
115 V AC/ 60 Hz	0.040	12.000	0.00			83.54%
	5.017	11.990	0.35	4.20	83.65%	
	9.973	11.980	0.70	8.39	84.09%	
	15.081	11.970	1.05	12.57	83.34%	
	20.156	11.960	1.40	16.74	83.07%	
230 V AC/ 50 Hz	0.050	12.000	0.00			83.55%
	5.076	11.990	0.35	4.20	82.67%	
	10.093	11.980	0.70	8.39	83.09%	
	14.930	11.970	1.05	12.57	84.18%	
	19.880	11.962	1.40	16.75	84.24%	
264 V AC/ 50 Hz	0.056	12.000	0.00			83.16%
	5.144	11.990	0.35	4.20	81.58%	
	10.097	11.980	0.70	8.39	83.05%	
	14.984	11.970	1.05	12.57	83.88%	
	19.910	11.962	1.40	16.75	84.11%	

Note: Single-output (+12 V) efficiency measurement was done by removing two LDO regulators and adding a Zener clamp circuit (R26 = 10 Ω, D6 = 22 V Zener). The reference board is not optimized for single-output configuration. The above efficiency data is for illustration only.

Measurement data and graphs

9.1 Efficiency curve

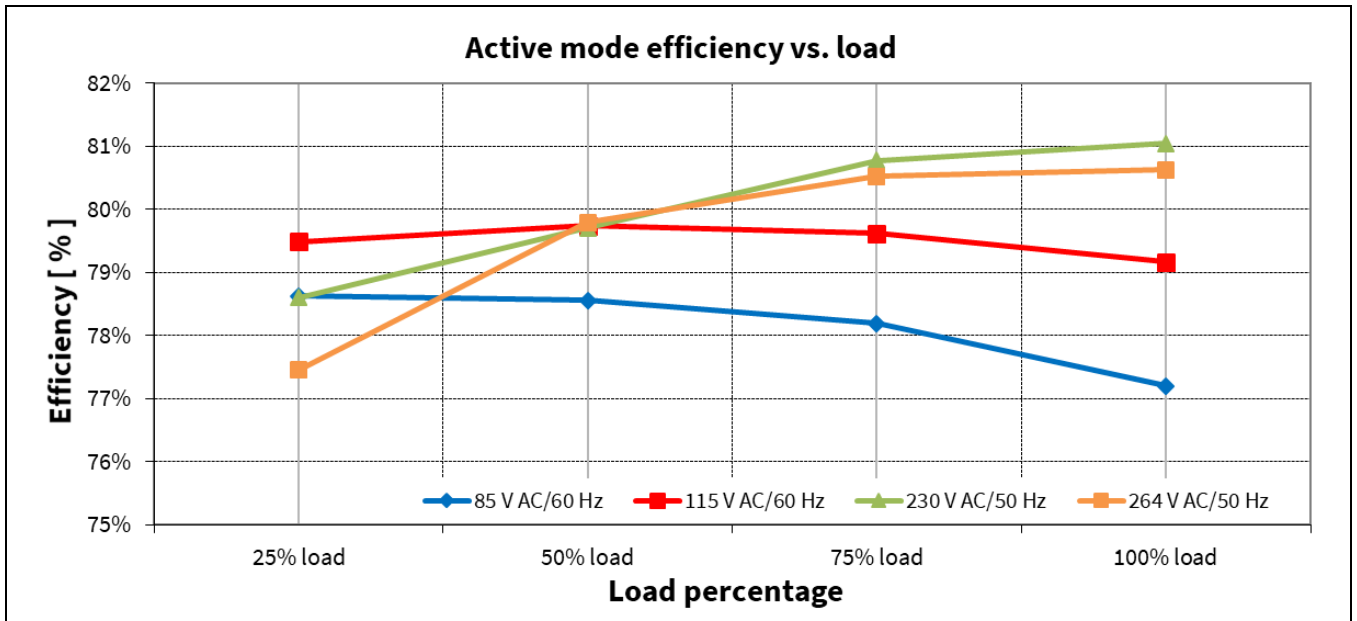

Figure 9 Efficiency vs. output load

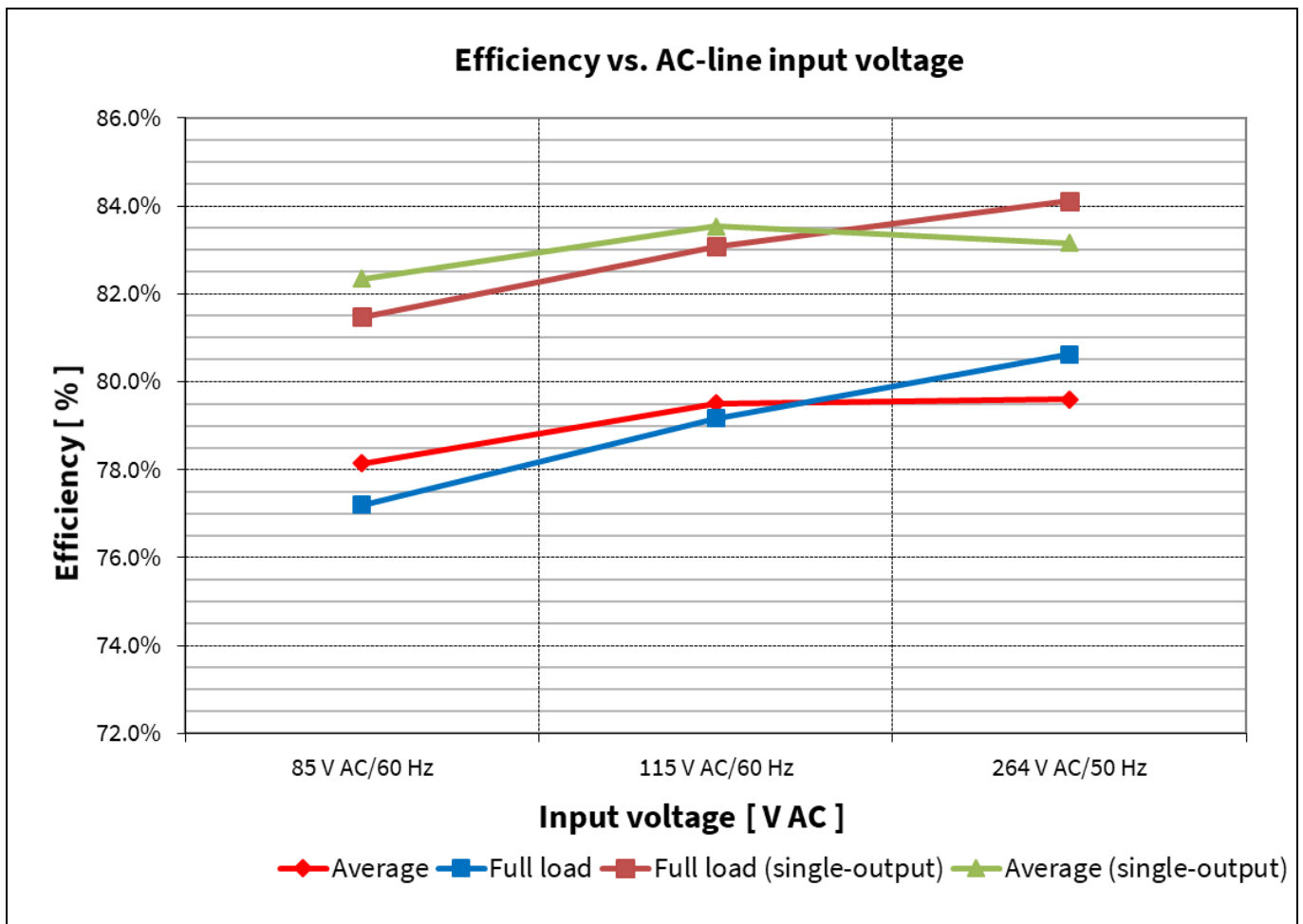

Figure 10 Efficiency vs. AC-line input voltage

Measurement data and graphs

9.2 Standby power

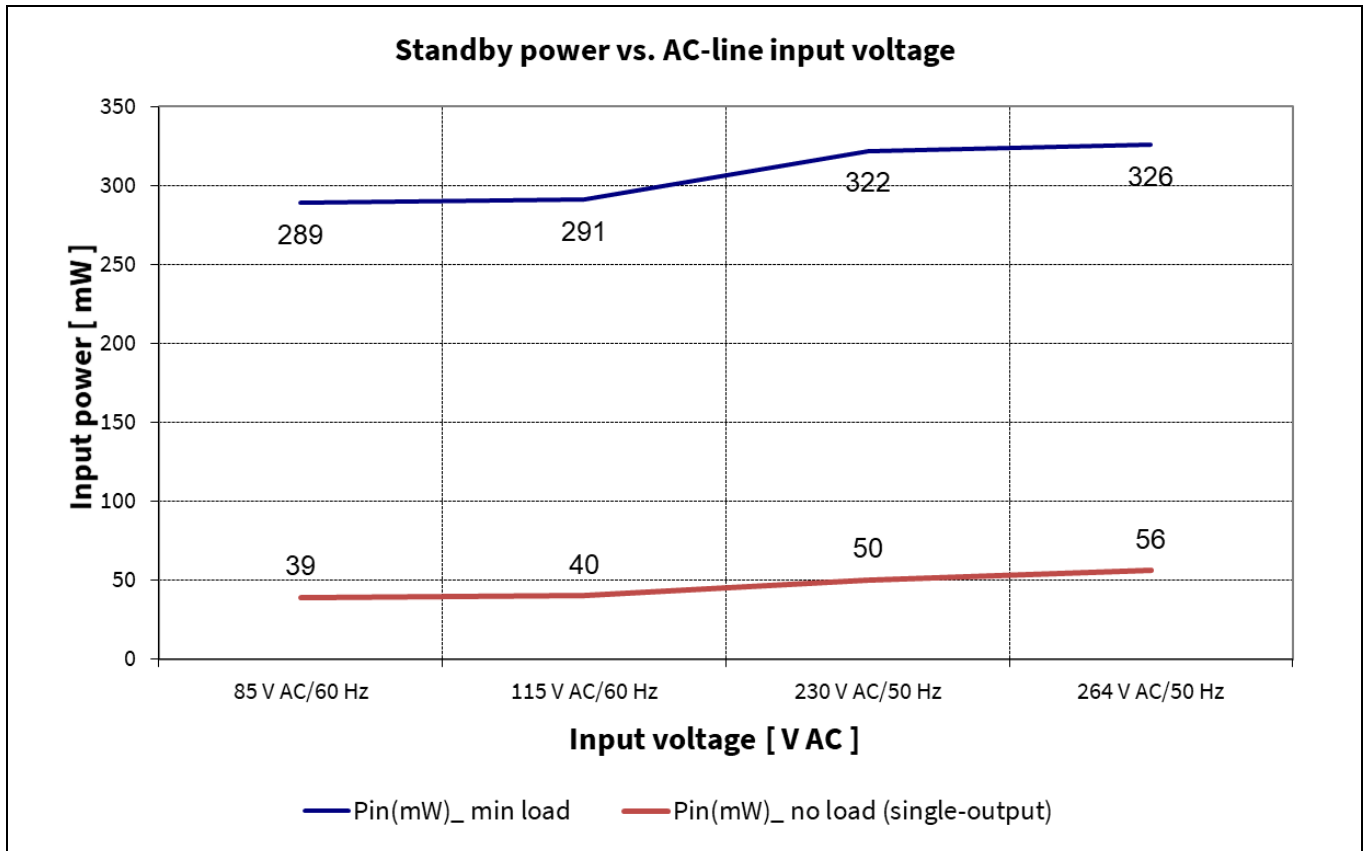

Figure 11 Standby power vs. AC-line input voltage

9.3 Line and load regulation

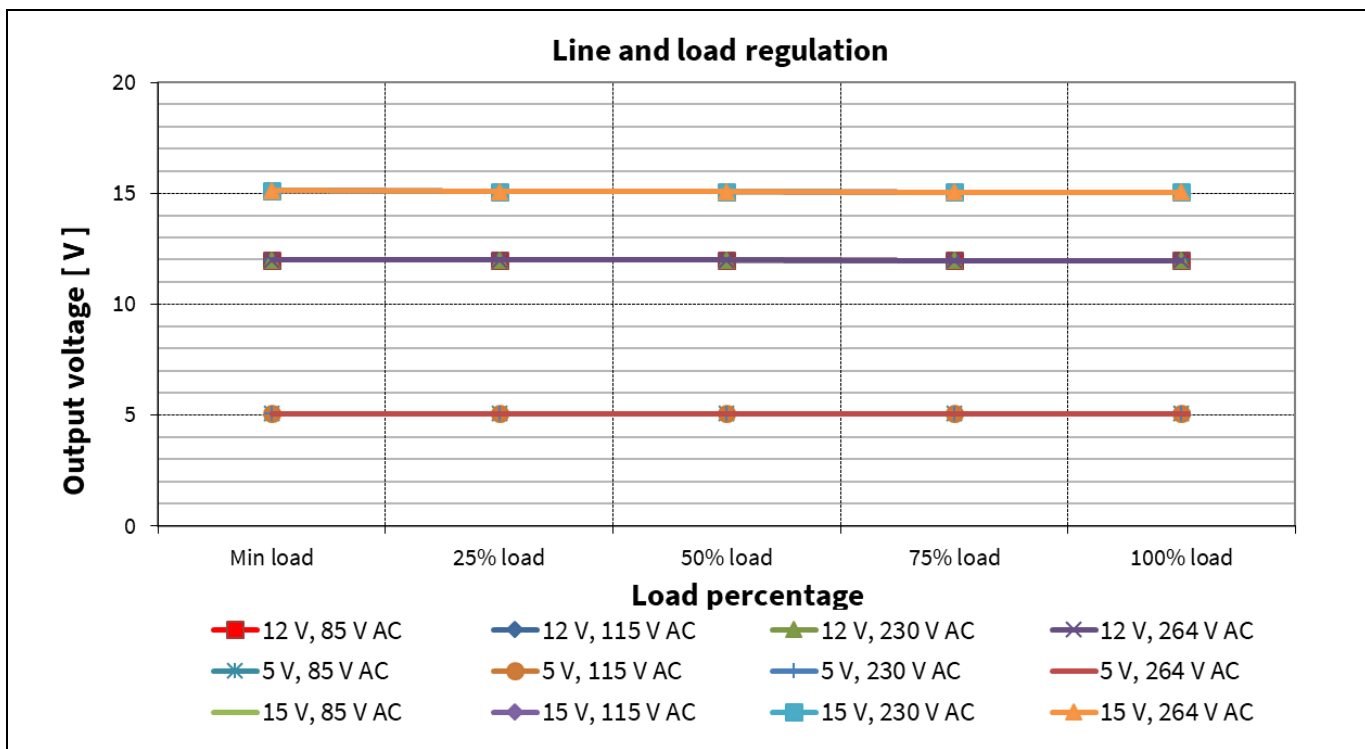

Figure 12 Line and load regulation

9.4 Maximum input power

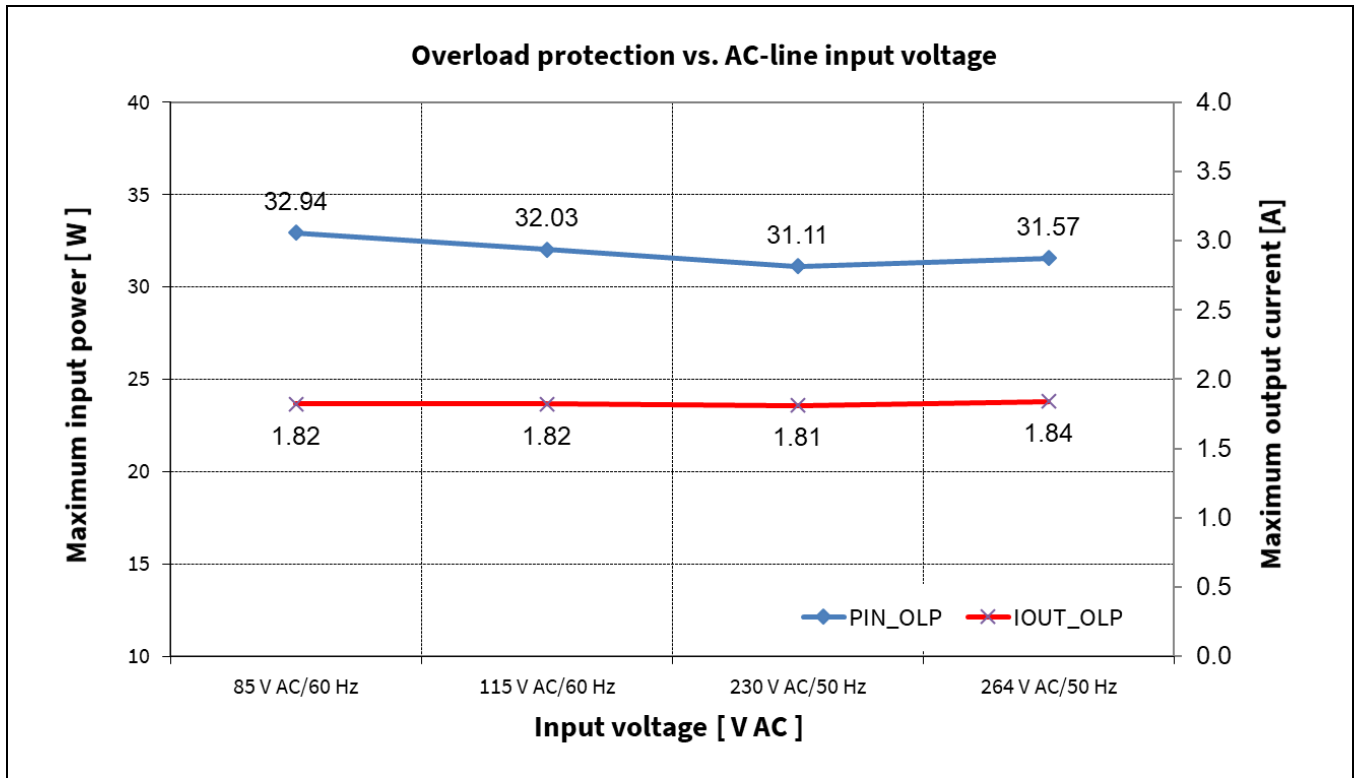

Figure 13 Maximum input power and 12 V output current before overload protection vs. AC-line input voltage (5 V/300 mA and 15 V/150 mA)

9.5 ESD immunity (EN 61000-4-2)

The system was subjected to a ±8 kV air and ±6 kV contact discharge ESD test according to EN 61000-4-2. A test failure was defined as non-recoverable.

Table 7 System ESD test result

Description	ESD test	Level	Number of strikes			Test result
			V ₀₁	V ₀₂	GND1	
115 V AC, 22 W	Contact	±6 kV	10	10	10	Pass
	Air	±8 kV	10	10	10	Pass
230 V AC, 22 W	Contact	±6 kV	10	10	10	Pass
	Air	±8 kV	10	10	10	Pass

9.6 Surge immunity (EN 61000-4-5)

The reference board was subjected to a surge immunity test (±2 kV DM and ±4 kV CM) according to EN 61000-4-5. It was tested at full load (resistive load). A test failure was defined as non-recoverable.

Description	Test	Level		Number of strikes				Test result
				0°	90°	180°	270°	
115 V AC	DM	±2 kV	L → N	3	3	3	3	Pass
		±4 kV	L → G	3	3	3	3	Pass
	CM	±4 kV	N → G	3	3	3	3	Pass
230 V AC	DM	±2 kV	L → N	3	3	3	3	Pass

Measurement data and graphs

	CM	±4 kV	L → G	3	3	3	3	Pass
		±4 kV	N → G	3	3	3	3	Pass

9.7 Conducted emissions (EN 55022 class B)

The conducted EMI was measured by Schaffner (SMR4503) and followed the test standard of EN 55022 (CISPR 22) class B. The reference board was tested at full load (resistive load) at input voltage of 115 V AC and 230 V AC.

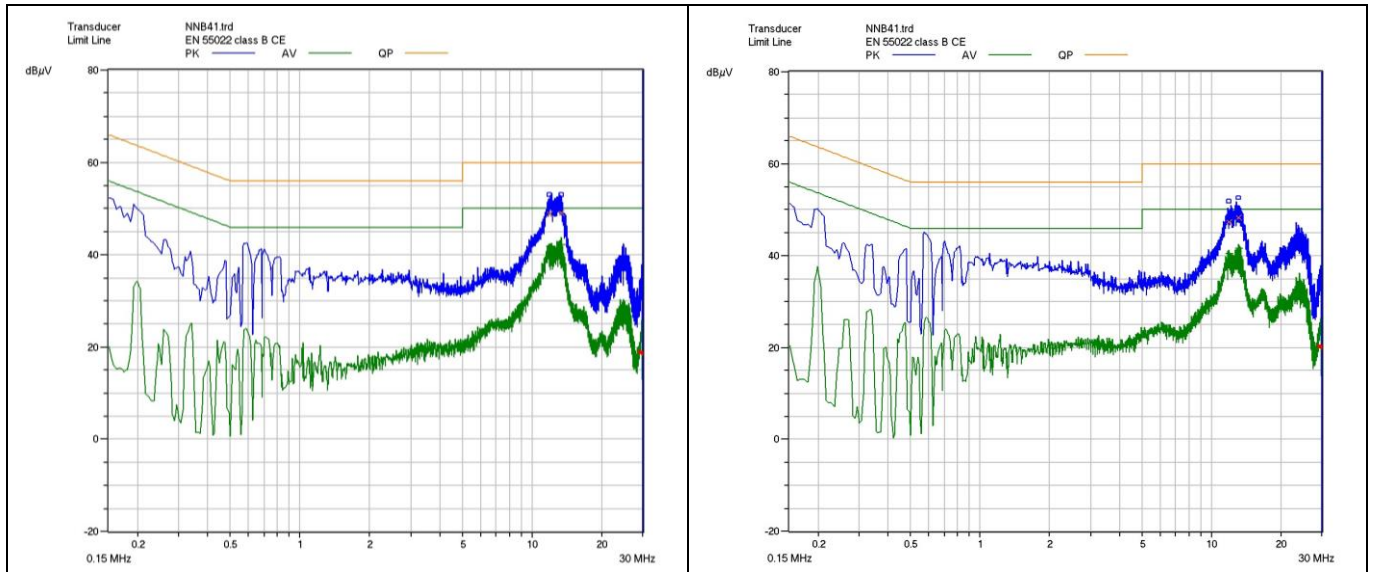

Figure 14 Conducted emissions at 115 V AC and full load on line (left) and neutral (right)

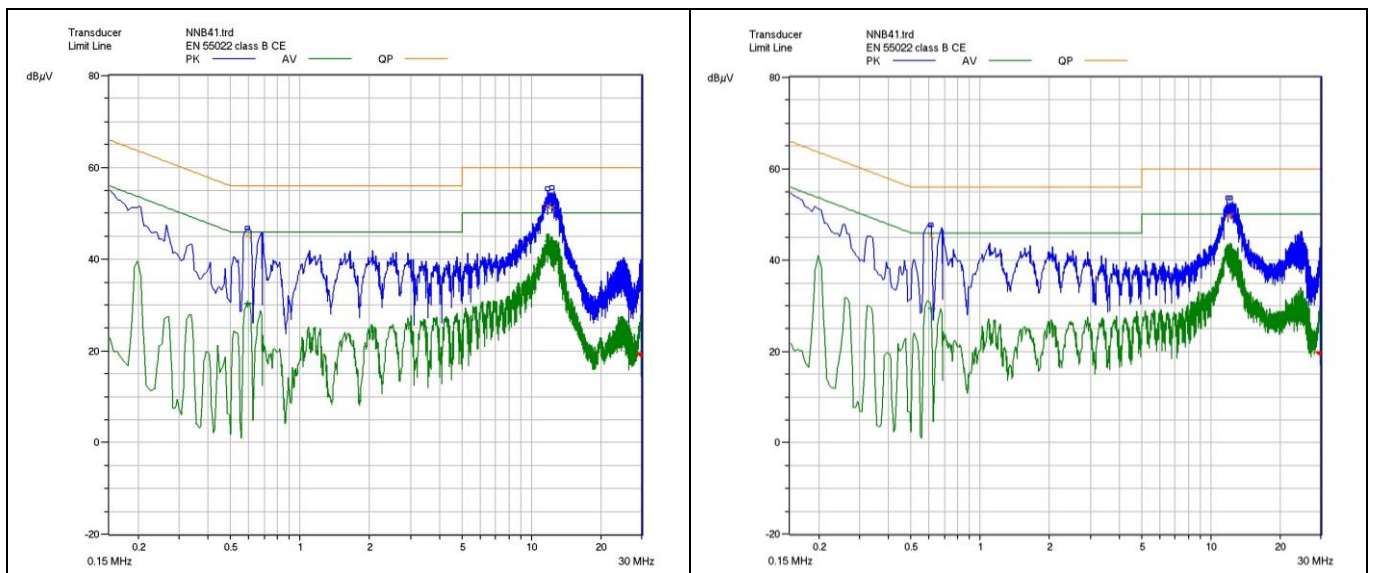

Figure 15 Conducted emissions at 230 V AC and full load on line (left) and neutral (right)

9.8 Thermal measurement

Thermal measurement was done by using an infrared thermography camera (FLIR-T62101) at an ambient temperature of 25°C taken after one hour running at full load. The temperature of the components was taken in an open-frame set-up.

22 W auxiliary power supply for indoor air-conditioner using ICE5BR2280BZ

Measurement data and graphs

Table 8 Thermal measurement of components (open-frame)

No.	Components	Temperature at 85 V AC (°C)	Temperature at 264 V AC (°C)
1	U2 (ICE5BR2280BZ)	73.6	68.8
2	U5 (L7815)	71.2	69.4
3	U1 (L7805)	73.6	68.1
4	TR1 (transformer)	56.3	57.6
5	D1 (output 1 diode)	91.3	90.4
6	D3 (output 2 diode)	67.0	67.6
7	D4 (output 3 diode)	63.8	63.9

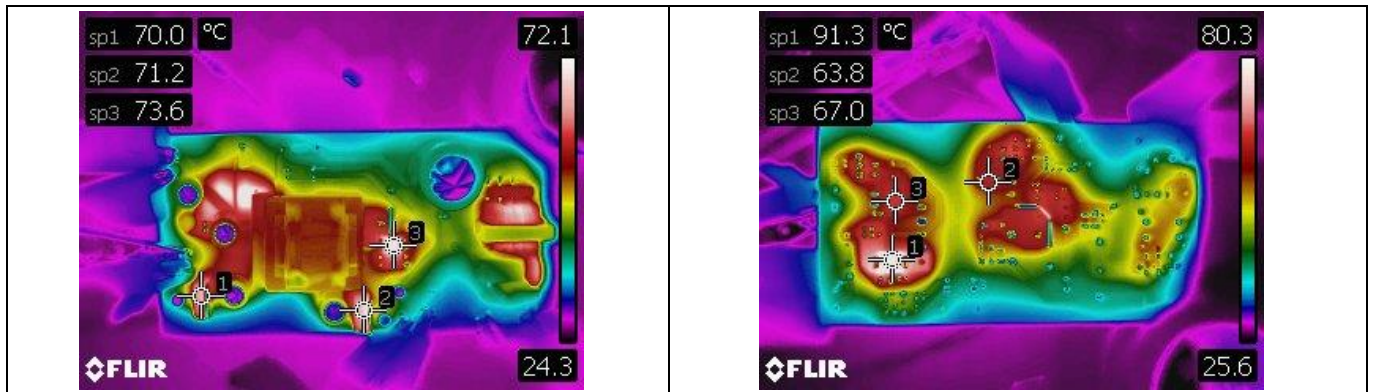

Figure 16 Top-side (left) and bottom-side (right) thermal image at 85 V AC input voltage

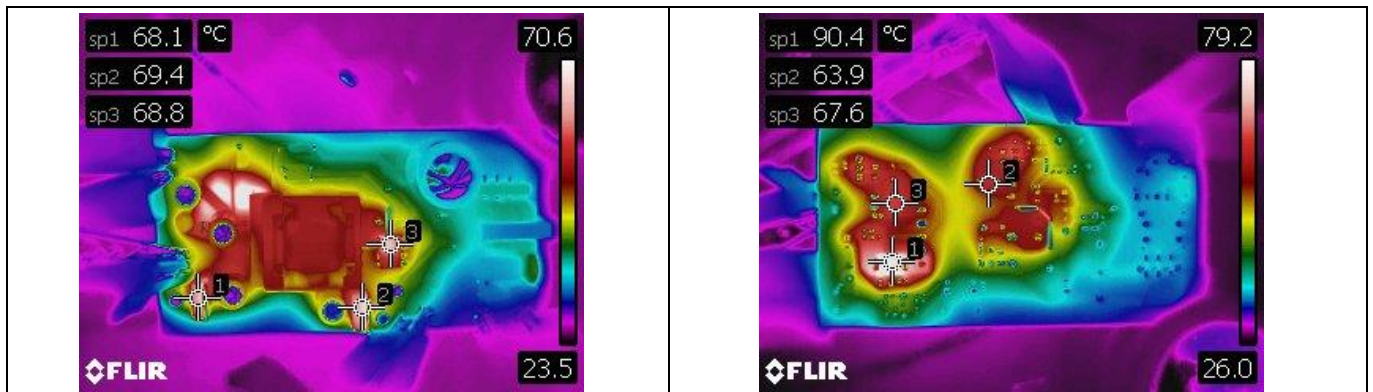

Figure 17 Top-side (left) and bottom-side (right) thermal image at 264 V AC input voltage

Measurement data and graphs

9.9 +18 V rail regulation (LDO input)

As the +15 V output via LDO is derived from the +18 V rail from the transformer which is also shared by the CoolSET™ V_{CC}, there are several design goals during normal operating conditions:

- Avoid V_{CC} UVLO (10 V typ.)
- Avoid V_{CC} OVP (25.5 V typ.)
- Meet the specification of the LDO: (V_{OUT} + 1~2 V) ≤ V_{IN} ≤ 30 V; load dependent

From the chart and table below, the +18 V rail is operating between 16.2 V and 23.90 V under different load combination and line conditions, which is well within the design objectives outlined above.

Table 9 +18 V rail line and load regulation

Conditions	12 V/0 A	12 V/0 mA	12 V/1.4 A	12 V/1.4 A
	5 V/0 A	5 V/5 mA	5 V/5 mA	5 V/0.3 A
	15 V/0 A	15 V/5 mA	15 V/5 mA	15 V/0.15 A
	(V)	(V)	(V)	(V)
85 V AC/60 Hz	16.87	16.22	23.75	18.34
115 V AC/60 Hz	16.86	16.20	23.90	18.32
230 V AC/50 Hz	16.89	16.26	23.73	18.33
264 V AC/50 Hz	16.84	16.20	23.58	18.32

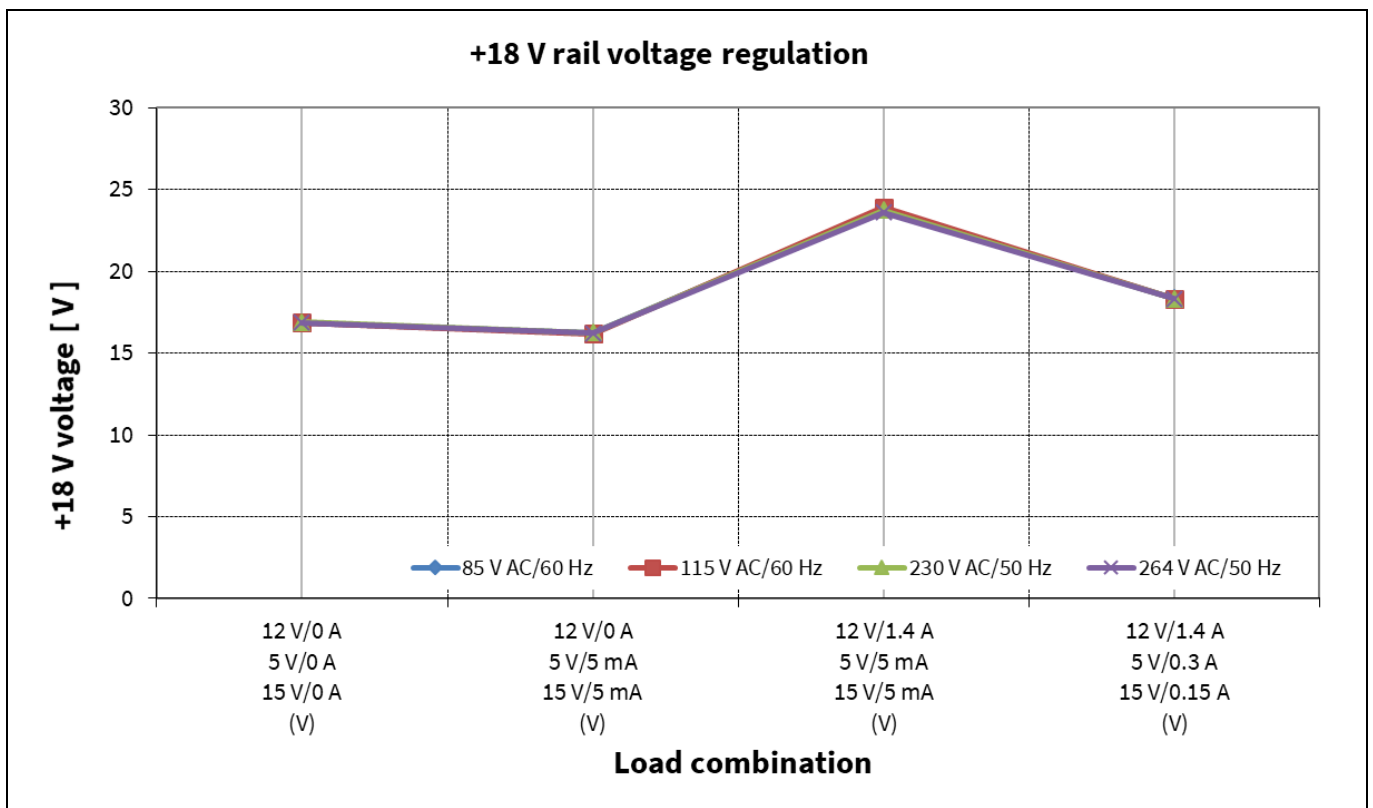

Figure 18 +18 V rail regulation

Waveforms and oscilloscope plots

10 Waveforms and oscilloscope plots

All waveforms and scope plots were recorded with a Teledyne LeCroy Waverunner 8054 oscilloscope.

10.1 Start-up at full load

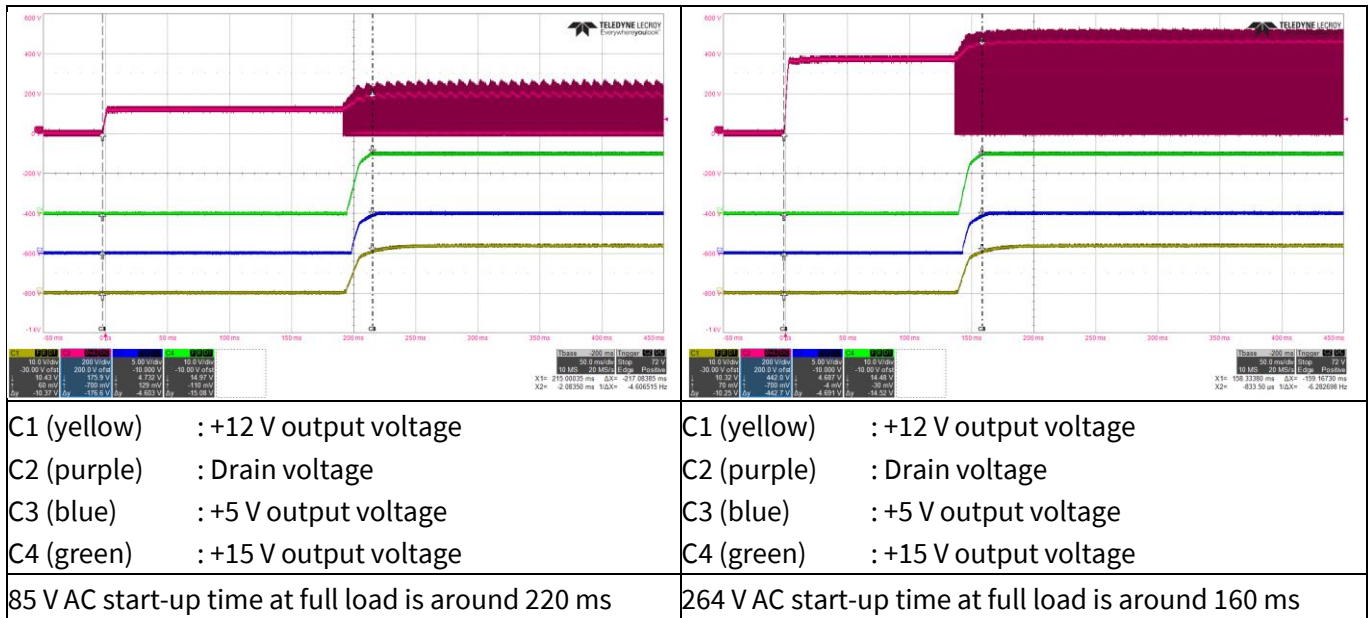

Figure 19 Start-up

10.2 Soft-start at full load

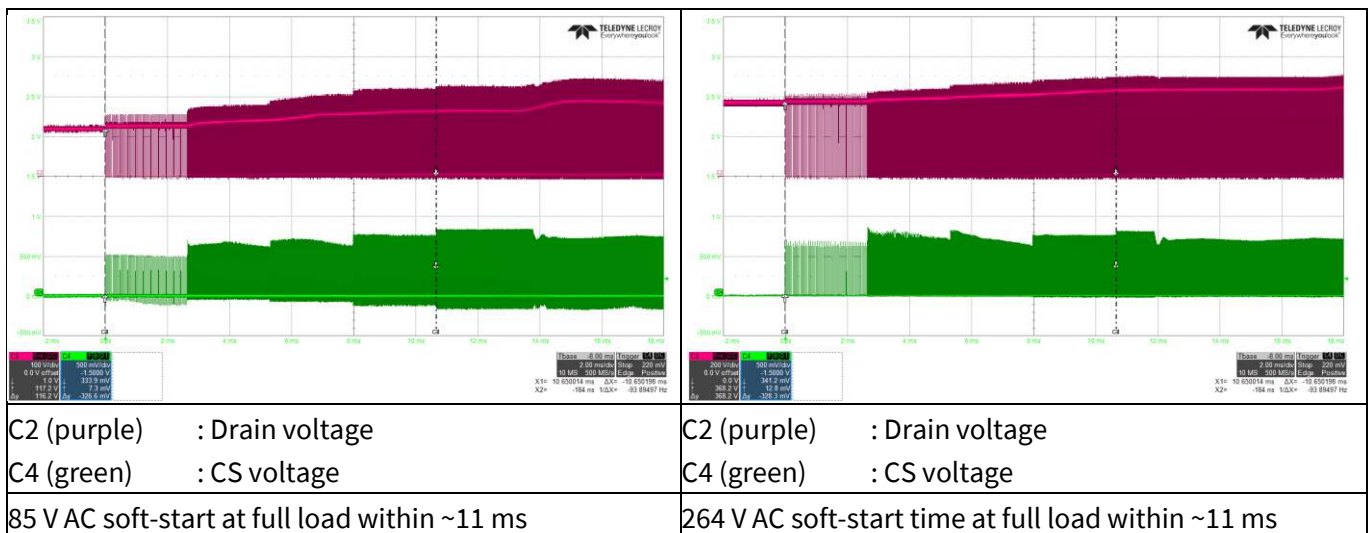

Figure 20 Soft-start

22 W auxiliary power supply for indoor air-conditioner using ICE5BR2280BZ

Waveforms and oscilloscope plots

10.3 Drain and CS voltage at full load

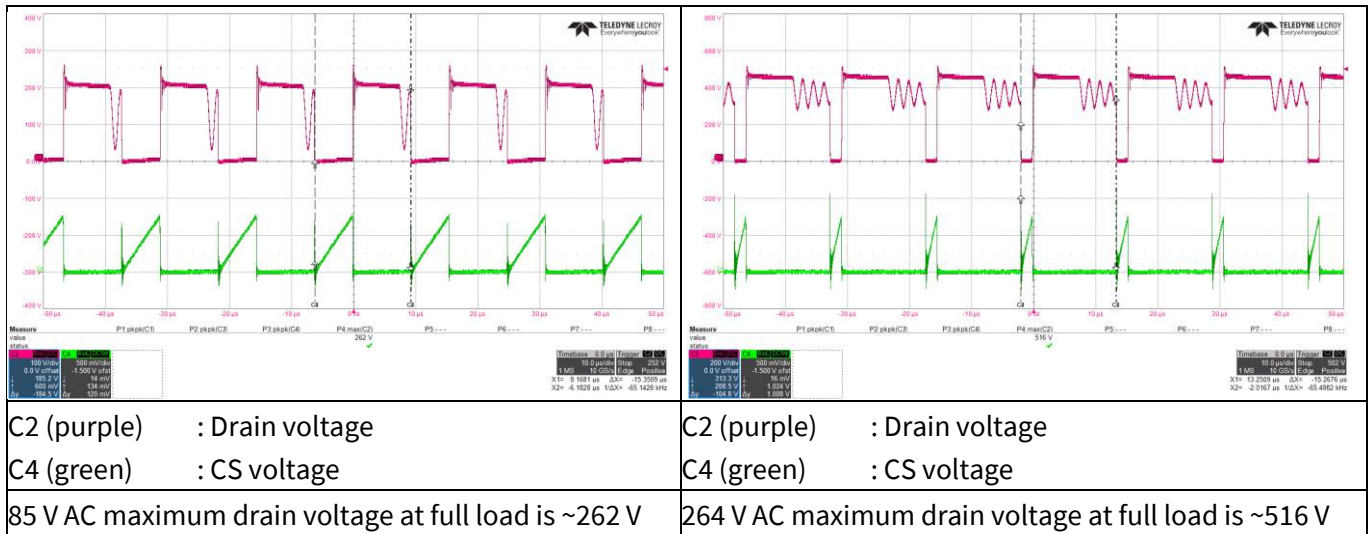

Figure 21 Drain and CS voltage

10.4 Frequency jittering

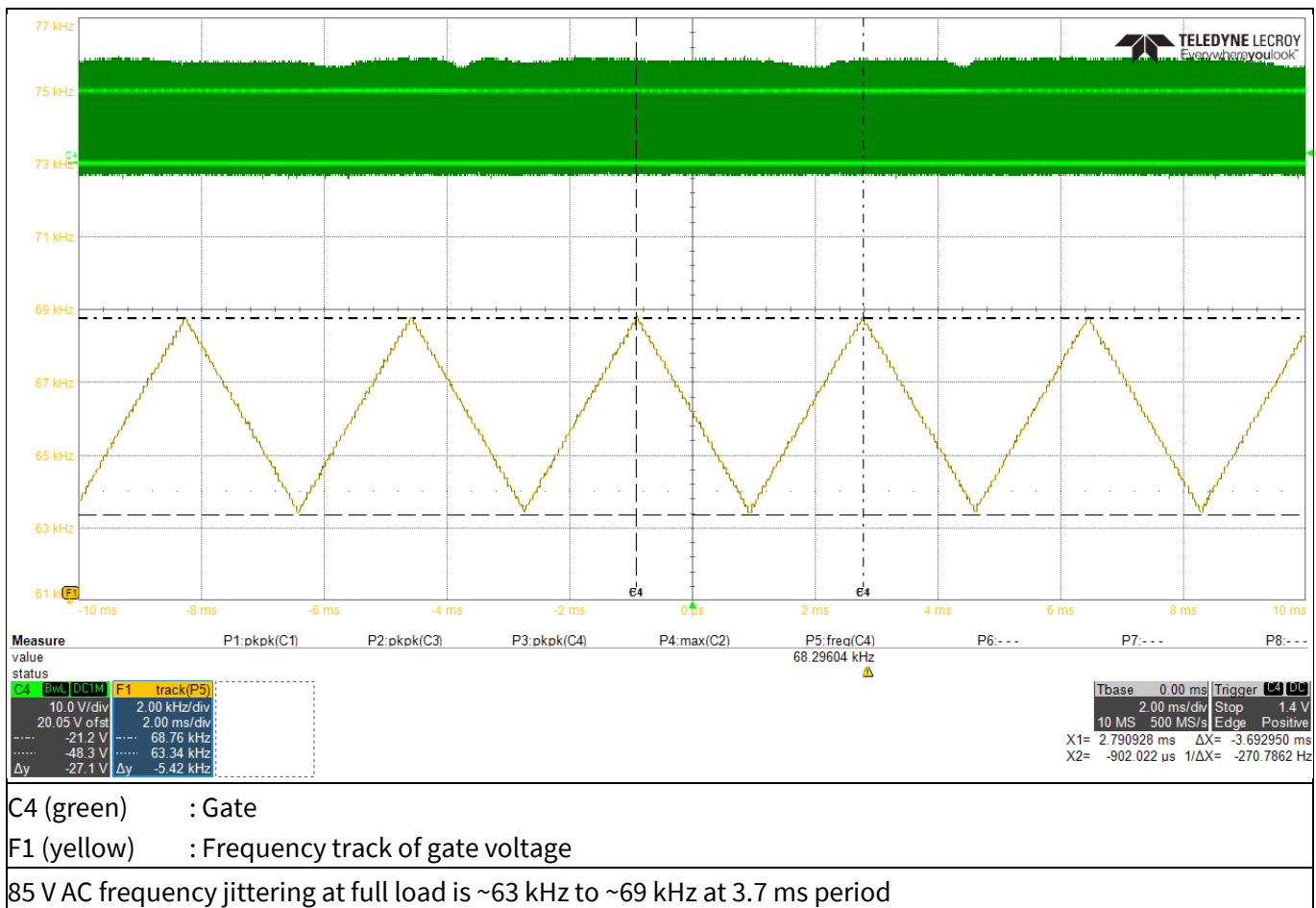

Figure 22 Frequency jittering

Waveforms and oscilloscope plots

10.5 Load-transient response

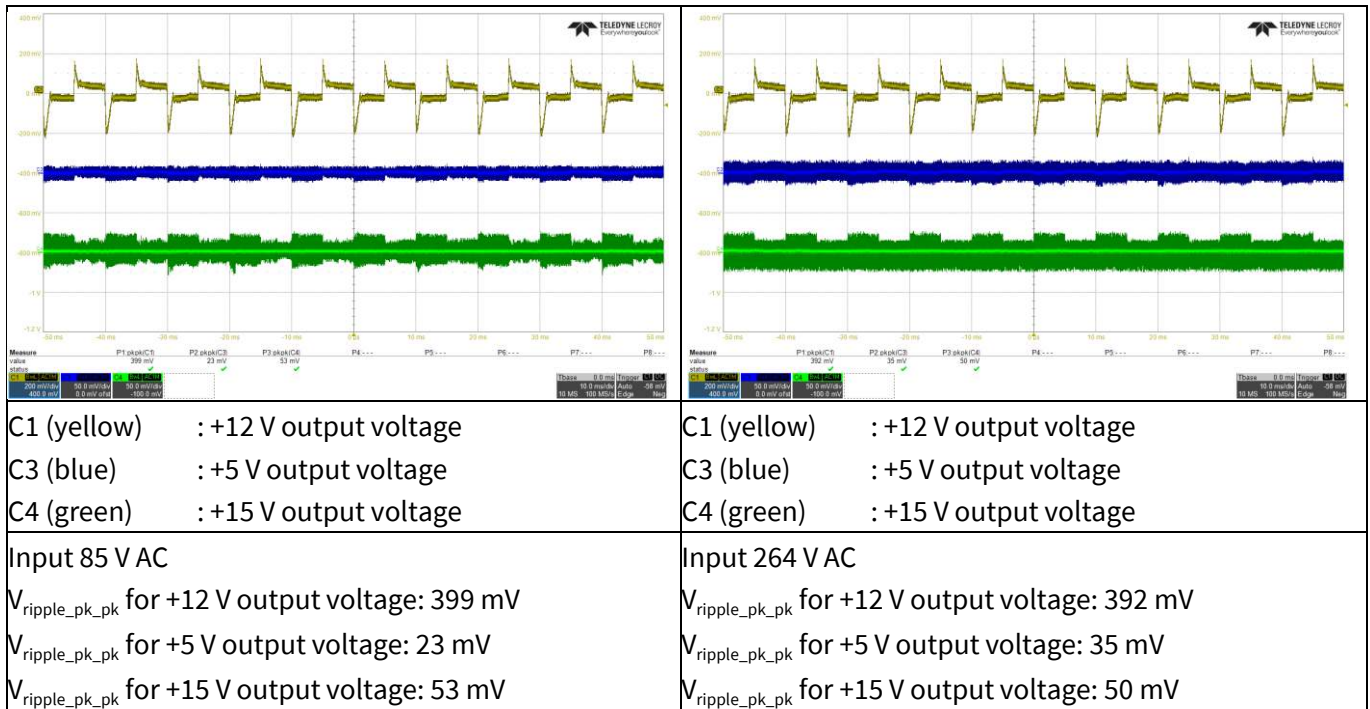

Figure 23 Load-transient response (+12 V output load change from 10 percent to 100 percent at 0.4 A/ μ s slew rate, 100 Hz, +15 V output and +5 V output load are fixed at full load; 20 MHz bandwidth and 10 μ F electrolytic capacitor in parallel with 0.1 μ F ceramic capacitor)

10.6 Output ripple voltage at full load

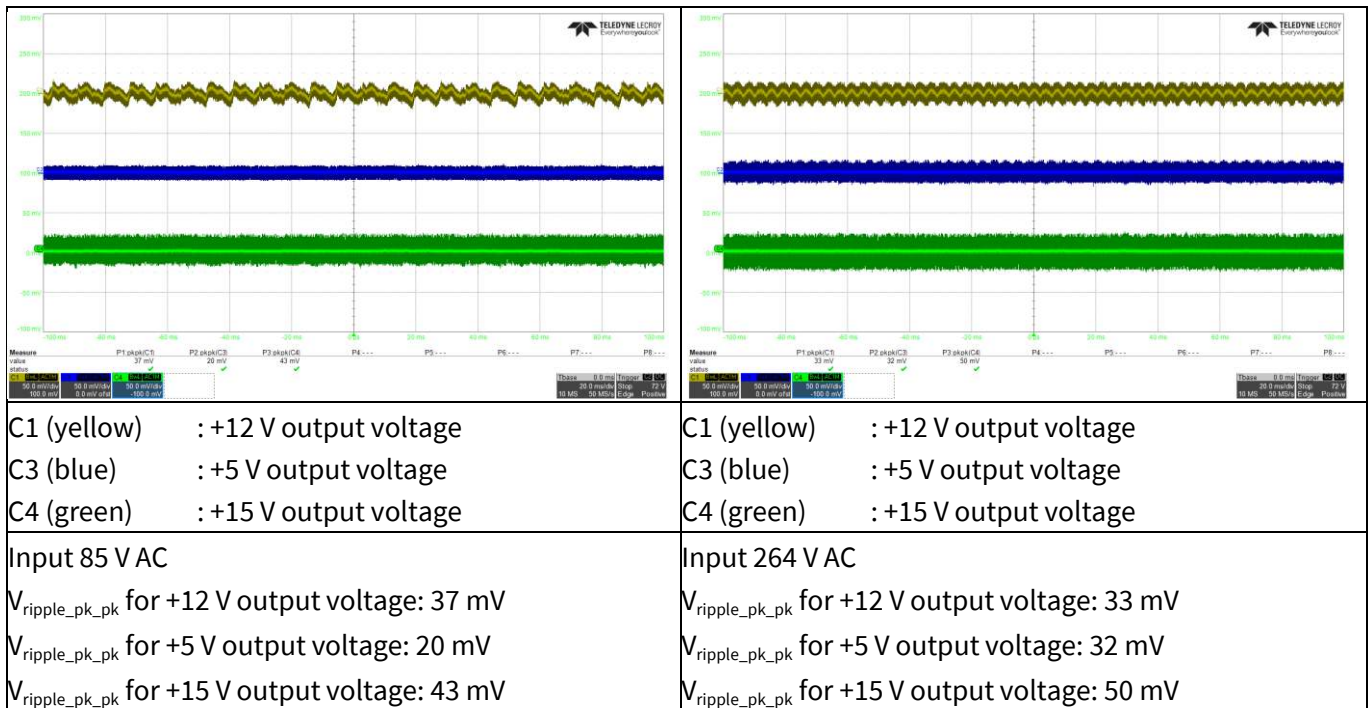

Figure 24 Output ripple voltage at full load (20 MHz bandwidth and 10 μ F electrolytic capacitor in parallel with 0.1 μ F ceramic capacitor)

Waveforms and oscilloscope plots

10.7 Output ripple voltage at ABM

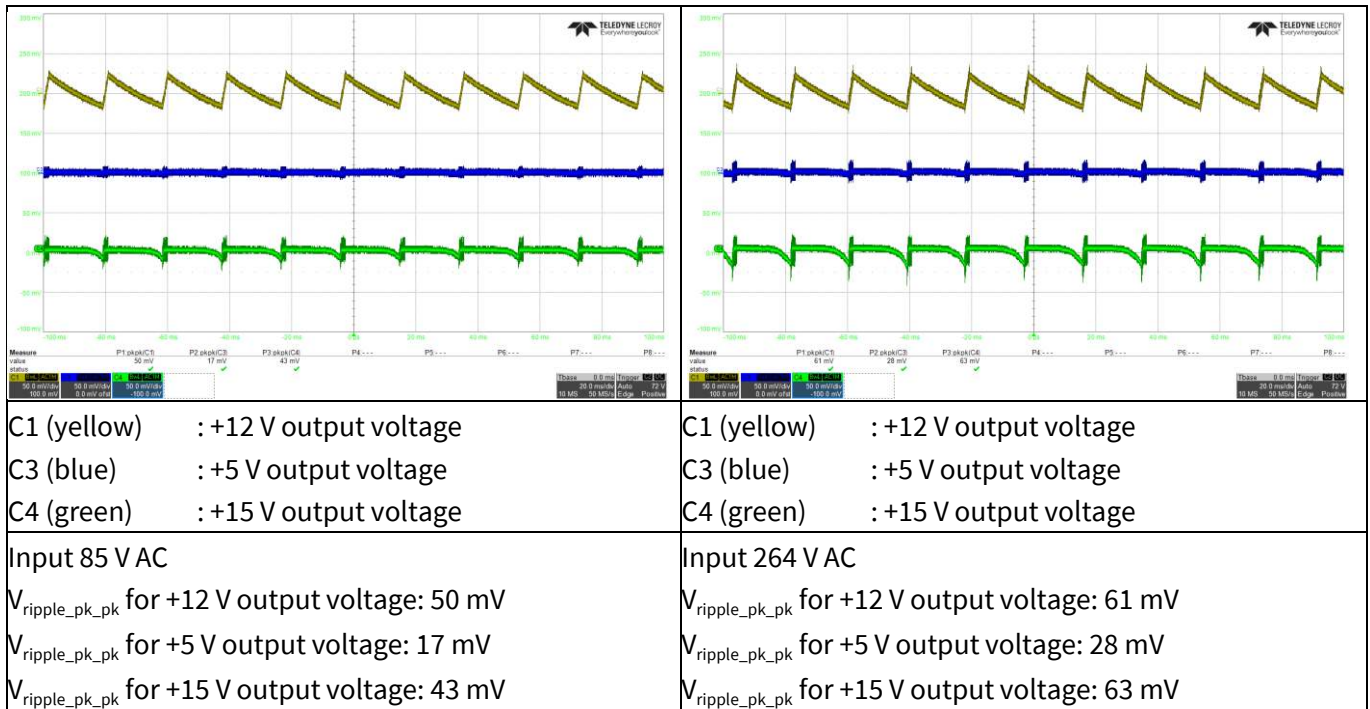

Figure 25 Output ripple voltage at ABM (20 MHz bandwidth and 10 μ F electrolytic capacitor in parallel with 0.1 μ F ceramic capacitor). Minimum load

10.8 Entering ABM

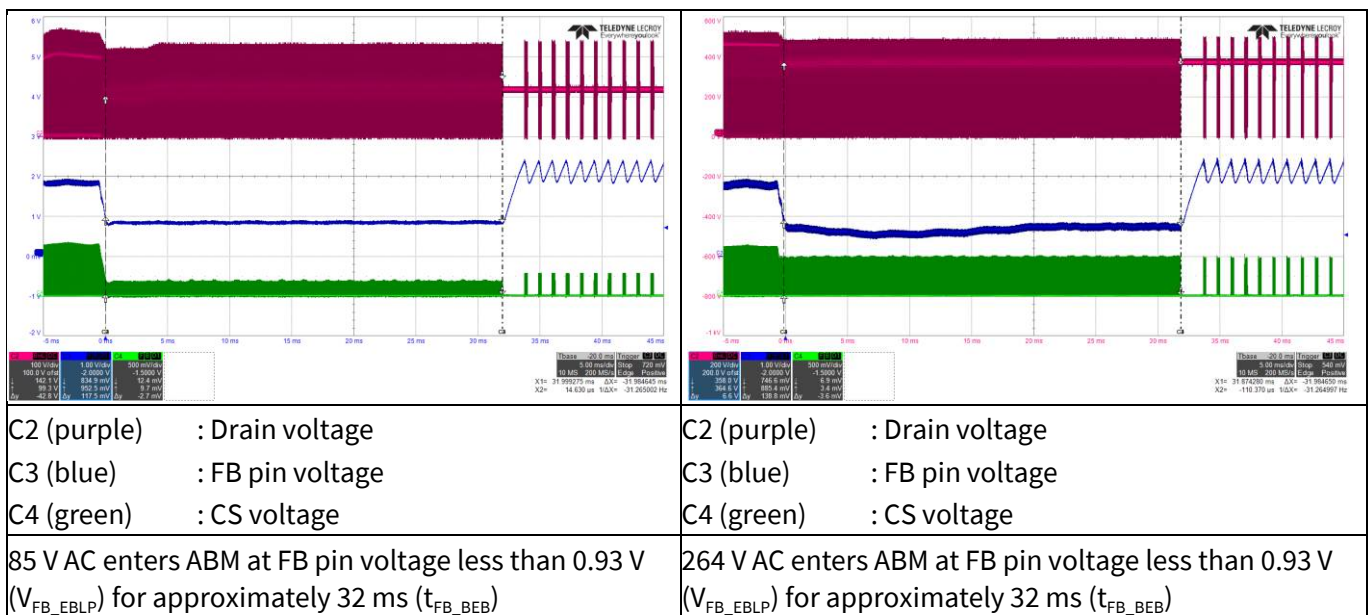

Figure 26 Entering ABM (+12 V output load change from 1.25 A to 50 mA; +15 V and +5 V outputs have minimum load)

22 W auxiliary power supply for indoor air-conditioner using ICE5BR2280BZ



Waveforms and oscilloscope plots

10.9 During ABM

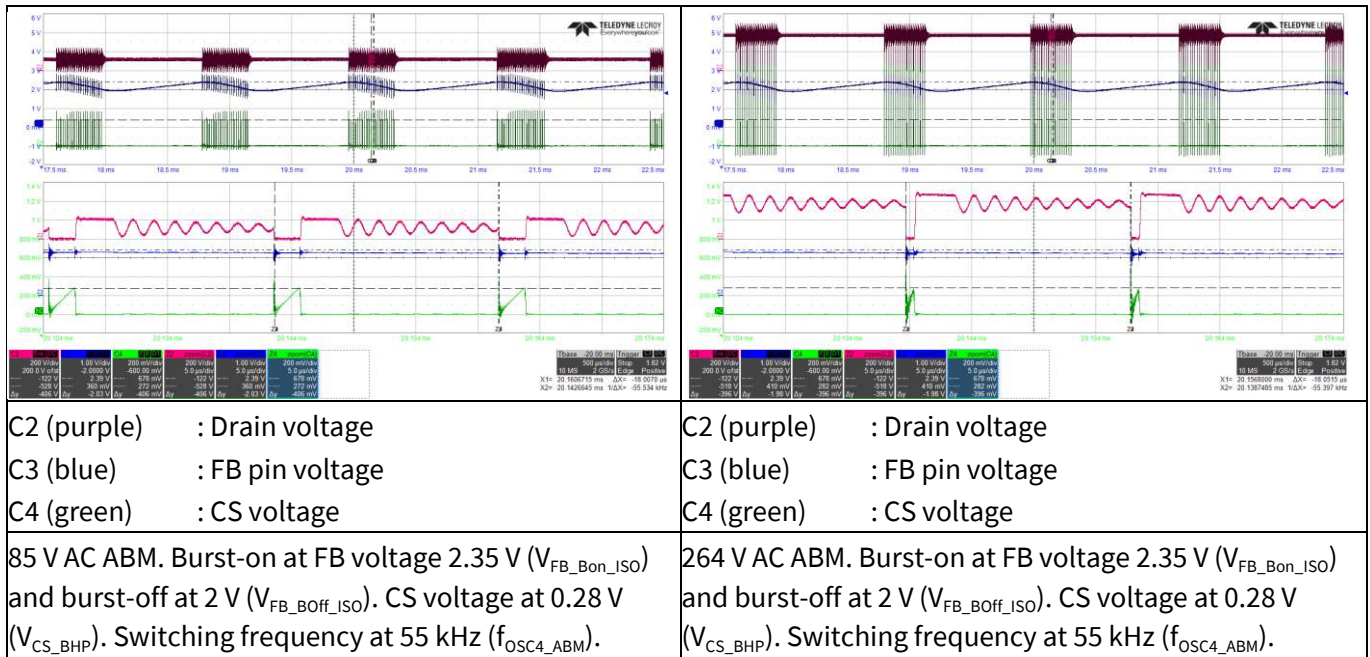

Figure 27 During ABM

10.10 Leaving ABM

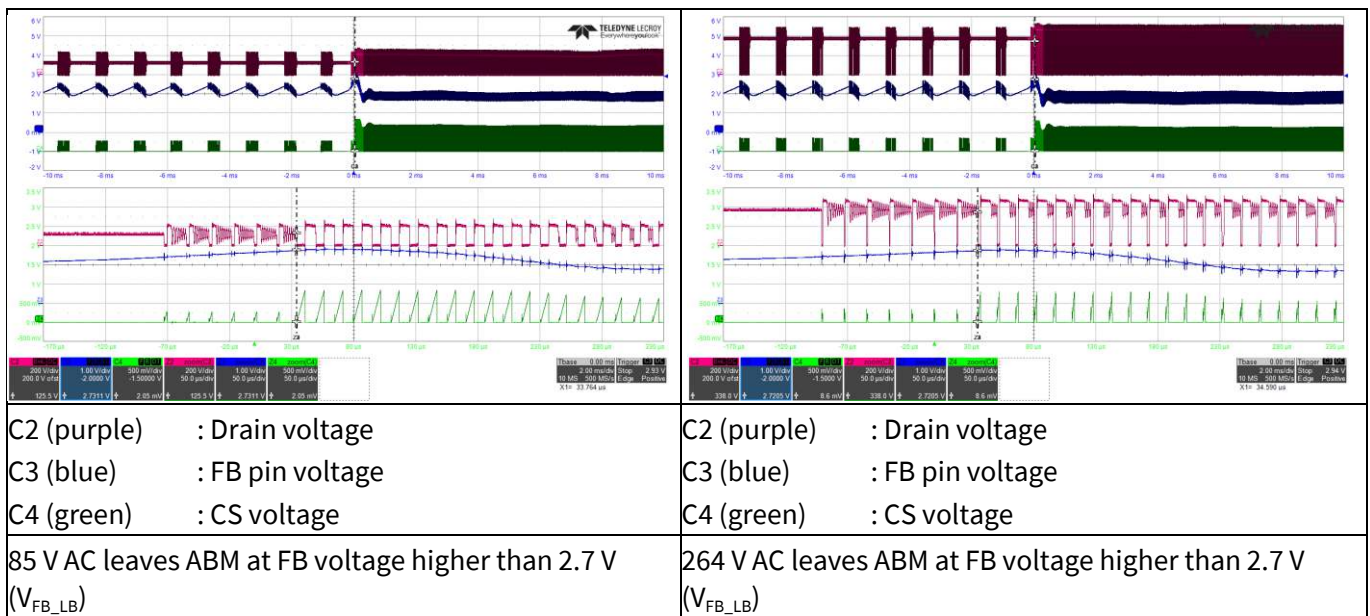

Figure 28 Leaving ABM (+12 V output load change from 50 mA to 1.4 A, +15 V and +5 V outputs have minimum load)

22 W auxiliary power supply for indoor air-conditioner using ICE5BR2280BZ



Waveforms and oscilloscope plots

10.11 V_{CC} OV/UV protection

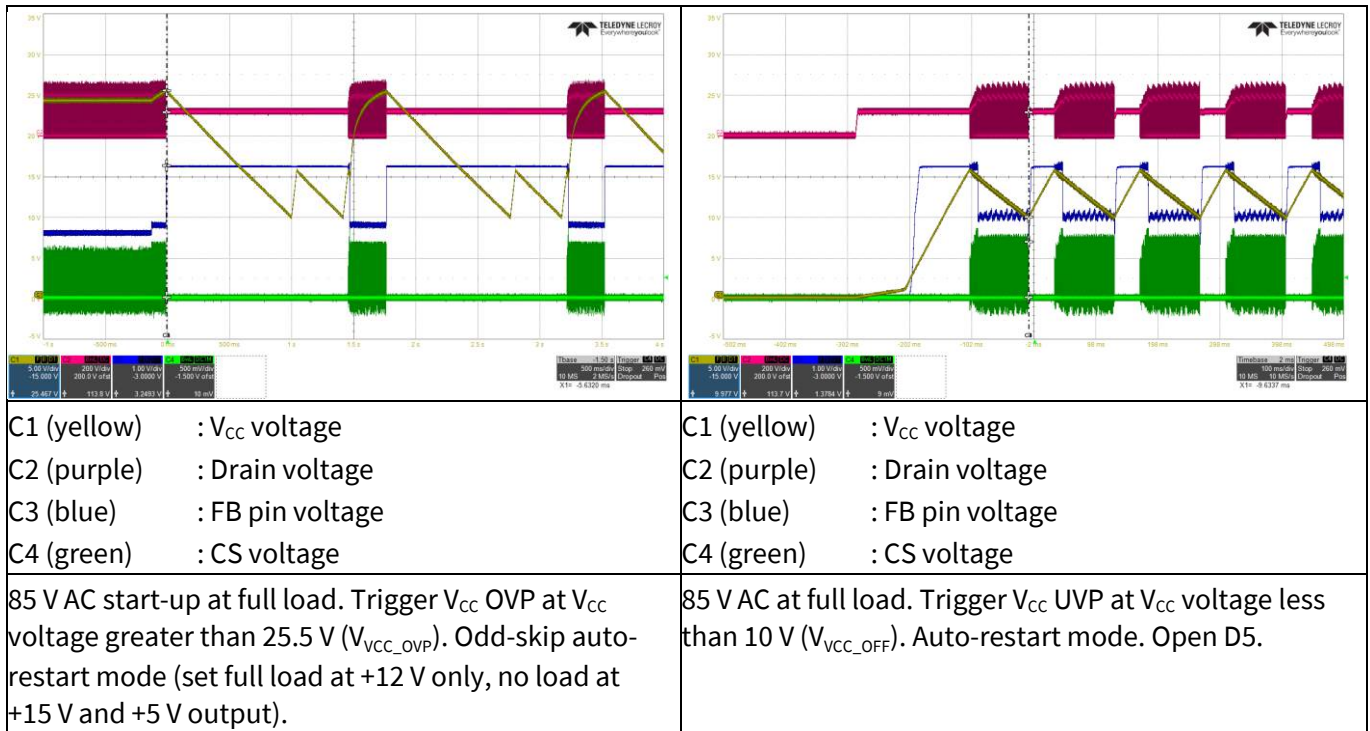

Figure 29 V_{CC} OV/UV protection

10.12 Overload protection

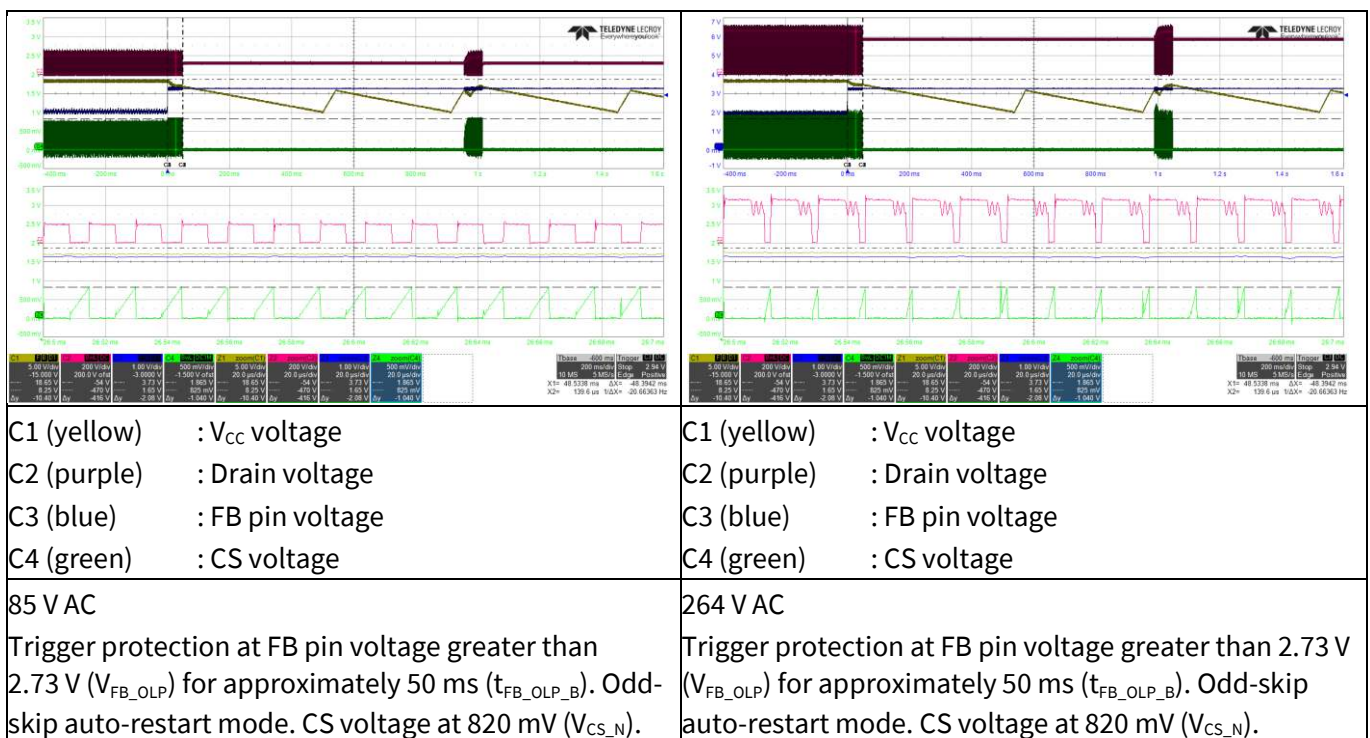

Figure 30 Overload protection (load increased at +12 V output from 1.4 A to 2 A to trigger protection; +15 V output and +5 V output fixed at full load)

11 Appendix A: Transformer design and spreadsheet [3]

Calculation tool for FF flyback converter using fifth-generation CoolSET™ (Version 1.1)

Project:	REF_5BR2280BZ_22W1
Application:	Aux for residential air-conditioner unit
CoolSET™:	ICE5BR2280BZ
Date:	16 April 2021
Revision:	V 1.1

Notes:

Enter design variables in orange-colored cells

Read design results in green-colored cells

Equation numbers are according to the design guide

Component designators below refer to the calculation tool

Select component values based on standard values available

Voltage/current rating does not include design margin, voltage spikes and transient currents

In “Output regulation”, only fill in either isolated or non-isolated, whichever is applicable

Description	Eq. #	Parameter	Unit	Value
-------------	-------	-----------	------	-------

Input, output, CoolSET™ specs

Line input

Description	Eq. #	Parameter	Unit	Value
Input		V_{ACMin}	[V]	85
Input		V_{ACMax}	[V]	264
Input		f_{AC}	[Hz]	60
Input		$V_{DCRipple}$	[V]	24

Output 1 specs

Description	Eq. #	Parameter	Unit	Value
Input		V_{Out1}	[V]	12
Input		I_{Out1}	[A]	1.40
Input		V_{FOut1}	[V]	0.6
Input		$V_{OutRipple1}$	[V]	0.2
Result	Eq. 001	P_{Out1}	[W]	16.8
Result	Eq. 004	K_{L1}		0.77

Output 2 specs

Description	Eq. #	Parameter	Unit	Value
Input		V_{Out2}	[V]	7.5
Input		I_{Out2}	[A]	0.3
Input		V_{FOut2}	[V]	0.2
Input		$V_{OutRipple2}$	[V]	0.2
Result	Eq. 002	P_{Out2}	[W]	2.25
Result	Eq. 005	K_{L2}		0.10

Auxiliary

Description	Eq. #	Parameter	Unit	Value
Input		V_{Vcc}	[V]	18
Input		I_{Vcc}	[A]	0.15
Input		V_{FOut3}	[V]	0.4
Input		V_{FVcc}	[V]	0.6
Result	Eq. 002	P_{Out2}	[W]	2.7

Power

Description	Eq. #	Parameter	Unit	Value
Input		η		0.83
Result	Eq. 003	P_{OutNom}	[W]	21.75
Input		P_{OutMax}	[W]	22
Result	Eq. 006	P_{InMax}	[W]	26.51
Input		P_{OutMin}	[W]	3

22 W auxiliary power supply for indoor air-conditioner using ICE5BR2280BZ



Appendix A: Transformer design and spreadsheet [3]

Controller/CoolSET™

	Controller/ CoolSET™				ICE5BR2280BZ
Input	Switching frequency		f_s	[Hz]	65000
Input	Targeted max. drain source voltage		V_{DSMax}	[V]	700
Input	Max. ambient temperature		T_{amax}	[°C]	50

Diode bridge and input capacitor

Diode bridge

Input	Power factor		$\cos\phi$		0.6
Result	Maximum AC input current	Eq. 007	I_{ACRMS}	[A]	0.520
Result	Peak voltage at V_{ACMax}	Eq. 008	$V_{DCMaxPk}$	[V]	373.35

Input capacitor

Result	Peak voltage at V_{ACMin}	Eq. 009	$V_{DCMinPk}$	[V]	120.21
Result	Selected minimum DC input voltage	Eq. 010	$V_{DCMinSet}$	[V]	96.21
Result	Discharging time at each half-line cycle	Eq. 011	T_D	[ms]	6.63
Result	Required energy at discharging time of input capacitor	Eq. 012	W_{in}	[Ws]	0.18
Result	Calculated input capacitor	Eq. 013	C_{INcal}	[μF]	67.65
Input	Select input capacitor (C1)		C_{in}	[μF]	68
Result	Calculated minimum DC input voltage	Eq. 015	V_{DCMin}	[V]	96.35

Transformer design

Drain voltage and current waveform

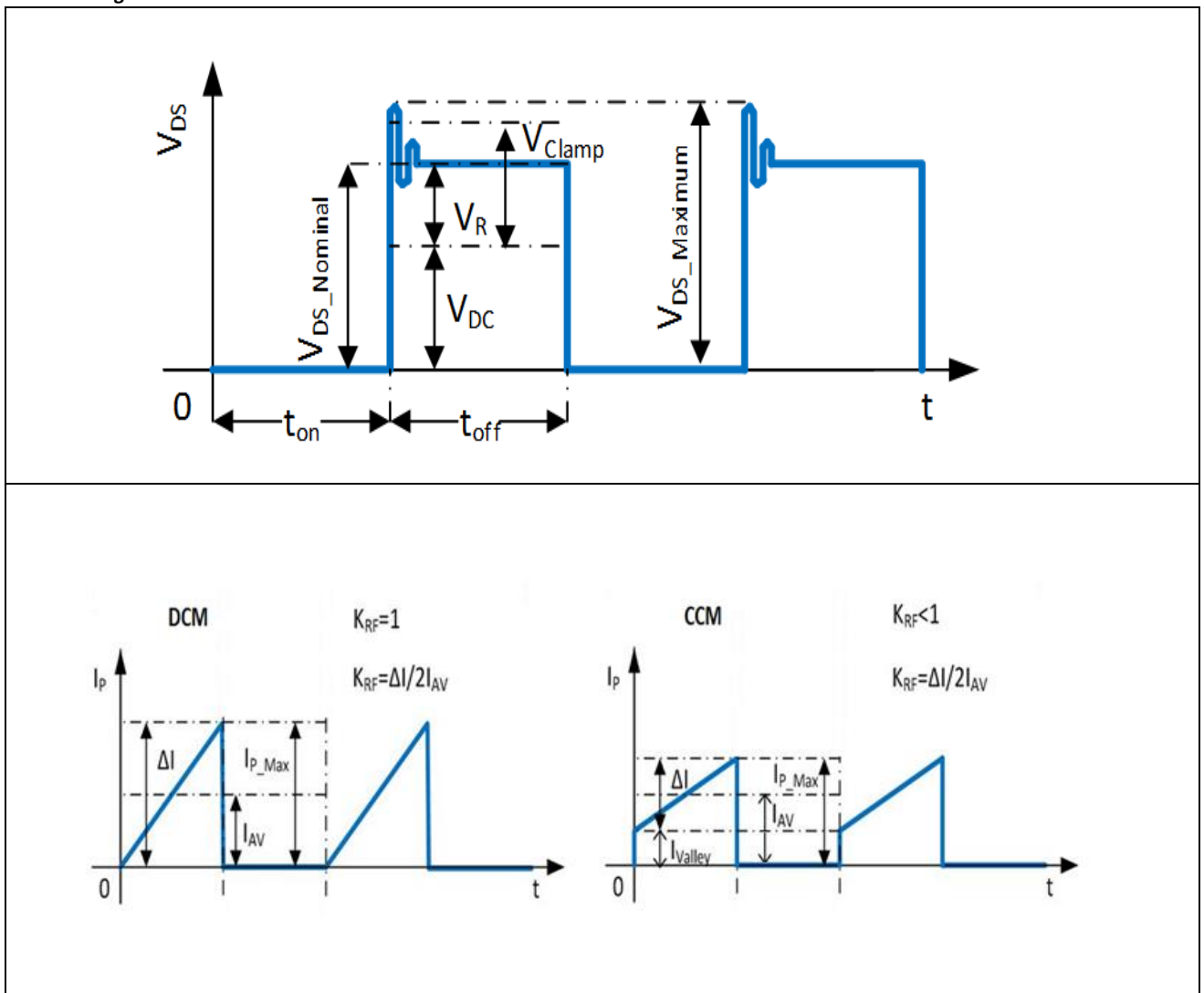

22 W auxiliary power supply for indoor air-conditioner using ICE5BR2280BZ



Appendix A: Transformer design and spreadsheet [3]

Primary inductance and winding currents

Input	Reflection voltage		V_{RSET}	[V]	90
Result	Maximum duty cycle	Eq. 016	D_{Max}		0.48
Input	Select current ripple factor		K_{RF}		1
Result	Primary inductance	Eq. 017	L_P	[H]	6.28E-04
Result	Primary turn-on average current	Eq. 018	I_{AV}	[A]	0.57
Result	Primary peak-to-peak current	Eq. 019	ΔI	[A]	1.14
Result	Primary peak current	Eq. 020	I_{PMax}	[A]	1.14
Result	Primary valley current	Eq. 021	I_{Valley}	[A]	0.00
Result	Primary RMS current	Eq. 022	I_{PRMS}	[A]	0.457

Select core type

Input	Select core type				2
Result	Core type				E25/13/7
Result	Core material				N87
Result	Maximum flux density		B_{Max}	[T]	0.3
Result	Cross-sectional area		A_e	[mm ²]	52
Result	Bobbin width		BW	[mm]	15.6
Result	Winding cross-section		A_N	[mm ²]	61
Result	Average length of turn		l_N	[mm]	50

Winding calculation

Result	Calculated minimum number of primary turns	Eq. 023	N_{PCal}	Turns	45.89
Input	Select number of primary turns		N_P	Turns	58
Result	Calculated number of secondary 1 turns	Eq. 024	N_{S1Cal}	Turns	8.12
Input	Select number of secondary 1 turns		N_{S1}	Turns	8
Result	Calculated number of secondary 2 turns	Eq. 025	N_{S2Cal}	Turns	4.96
Input	Select number of secondary 2 turns		N_{S2}	Turns	5
Result	Calculated number of auxiliary turns	Eq. 026	N_{VccCal}	Turns	11.81
Input	Select number of auxiliary turns		N_{Vcc}	Turns	12
Result	Calculated V_{CC} voltage	Eq. 027	V_{VccCal}	[V]	18.30

Post calculation

Result	Primary to secondary 1 turns ratio	Eq. 028	N_{PS1}		7.25
Result	Primary to secondary 2 turns ratio	Eq. 029	N_{PS2}		11.60
Result	Post calculated reflected voltage	Eq. 030	V_{RPost}	[V]	91.35
Result	Post calculated maximum duty cycle	Eq. 031	$D_{MaxPost}$		0.49
Result	Duty-cycle prime	Eq. 032	D_{Max}'		0.51
Result	Actual flux density	Eq. 033	B_{MaxAct}	[T]	0.237
Result	Maximum DC input voltage for CCM operation	Eq. 034	$V_{DCmaxCCM}$	[V]	94.85

Transformer winding design

Input	Margin according to safety standard		M	[mm]	0
Input	Copper space factor		f_{Cu}		0.4
Result	Effective bobbin window	Eq. 035	BW_E	[mm]	15.6
Result	Effective winding cross-section	Eq. 036	A_{Ne}	[mm ²]	61.0
Input	Primary winding area factor		AF_{NP}		0.45
Input	Secondary 1 winding area factor		AF_{NS1}		0.30
Input	Secondary 2 winding area factor		AF_{NS2}		0.15
Input	Auxiliary winding area factor		AF_{NVcc}		0.10

22 W auxiliary power supply for indoor air-conditioner using ICE5BR2280BZ



Appendix A: Transformer design and spreadsheet [3]

Primary winding

Result	Calculated wire copper cross-sectional area	Eq. 037	A_{PCal}	[mm ²]	0.1893
Result	Calculated maximum wire size	Eq. 038	AWG_{PCal}		24
Input	Select wire size		AWG_P		28
Input	Select number of parallel wires		n_{WP}		1
Result	Wire copper diameter	Eq. 039	d_P	[mm]	0.32
Result	Wire copper cross-sectional area	Eq. 040	A_P	[mm ²]	0.0821
Result	Wire current density	Eq. 041	S_P	[A/mm ²]	5.57
Input	Insulation thickness		INS_P	[mm]	0.01
Result	Turns per layer	Eq. 042	NL_P	Turns/layer	45
Result	Number of layers	Eq. 043	Ln_P	Layers	2

Secondary 1 winding

Result	Calculated wire copper cross-sectional area	Eq. 044	A_{NS1Cal}	[mm ²]	0.9150
Result	Calculated maximum wire size	Eq. 045	AWG_{S1Cal}		18
Input	Select wire size		AWG_{S1}		24
Input	Select number of parallel wires		n_{WS1}		2
Result	Wire copper diameter	Eq. 046	d_{S1}	[mm]	0.5131
Result	Wire copper cross-sectional area	Eq. 047	A_{S1}	[mm ²]	0.4136
Result	Peak current	Eq. 048	I_{S1Max}	[A]	6.3797
Result	RMS current	Eq. 049	I_{S1RMS}	[A]	2.6289
Result	Wire current density	Eq. 050	S_{S1}	[A/mm ²]	6.36
Input	Insulation thickness		INS_{S1}	[mm]	0.02
Result	Turns per layer	Eq. 051	NL_{S1}	Turns/layer	8
Result	Number of layers	Eq. 052	Ln_{S1}	Layers	1

Secondary 2 winding

Result	Calculated wire copper cross-sectional area	Eq. 053	A_{NS2Cal}	[mm ²]	0.7320
Result	Calculated maximum wire size	Eq. 054	AWG_{S2Cal}		19
Input	Select wire size		AWG_{S2}		24
Input	Select number of parallel wires		n_{WS2}		1
Result	Wire copper diameter	Eq. 055	d_{S2}	[mm]	0.5131
Result	Wire copper cross-sectional area	Eq. 056	A_{S2}	[mm ²]	0.2068
Result	Peak current	Eq. 057	I_{S2Max}	[A]	1.3671
Result	RMS current	Eq. 058	I_{S2RMS}	[A]	0.5633
Result	Wire current density	Eq. 059	S_{S2}	[A/mm ²]	2.72
Input	Insulation thickness		INS_{S2}	[mm]	0.02
Result	Turns per layer	Eq. 060	NL_{S2}	Turns/layer	28
Result	Number of layers	Eq. 061	Ln_{S2}	Layers	1

RCD clamper and CS resistor

RCD clamper circuit

Input	Leakage inductance percentage		$L_{LK\%}$	[%]	2
Result	Leakage inductance	Eq. 062	L_{LK}	[H]	1.26E-05
Result	Clamping voltage	Eq. 063	V_{Clamp}	[V]	235.30
Result	Calculated clamping capacitor	Eq. 064	$C_{ClampCal}$	[nF]	0.21
Input	Select clamping capacitor value (C2)		C_{Clamp}	[nF]	1
Result	Calculated clamping resistor	Eq. 065	$R_{ClampCal}$	[kΩ]	185.5
Input	Select clamping resistor value (R4)		R_{Clamp}	[kΩ]	240

CS resistor

Input	Current sense threshold value from datasheet		V_{CS_N}	[V]	0.8
Result	Calculated current sense resistor (R8A, R8B)	Eq. 066	R_{sense}	[Ω]	0.70

22 W auxiliary power supply for indoor air-conditioner using ICE5BR2280BZ



Appendix A: Transformer design and spreadsheet [3]

Output rectifier

Secondary 1 output rectifier

Result	Diode reverse voltage	Eq. 067	$V_{RDiode1}$	[V]	63.50
Result	Diode RMS current		I_{S1RMS}	[A]	2.63
Input	Max. voltage undershoot at output capacitor		ΔV_{Out1}	[V]	0.4
Input	Number of clock periods		n_{cp1}		10
Result	Output capacitor ripple current	Eq. 068	$I_{Ripple1}$	[A]	2.23
Result	Calculated minimum output capacitor	Eq. 069	$C_{Out1Cal}$	[μ F]	538
Input	Select output capacitor value (C152)		C_{Out1}	[μ F]	560
Input	ESR (Z_{max}) value from datasheet at 100 kHz		R_{ESR1}	[Ω]	0.032
Input	Number of parallel capacitors		n_{CCout1}		1
Result	Zero frequency of output capacitor	Eq. 070	f_{zCOut1}	[kHz]	8.88
Result	First stage ripple voltage	Eq. 071	$V_{Ripple1}$	[V]	0.204151
Input	Select LC filter inductor value (L151)		L_{out1}	[μ H]	4.7
Result	Calculated LC filter capacitor	Eq. 072	C_{LCCal1}	[μ F]	68.3
Input	Select LC filter capacitor value (C153)		C_{LC1}	[μ F]	220
Result	LC filter frequency	Eq. 073	f_{LC1}	[kHz]	4.95
Result	Second stage ripple voltage	Eq. 074	$V_{2ndRipple1}$	[mV]	1.18

Secondary 2 output rectifier

Result	Diode reverse voltage	Eq. 075	$V_{RDiode2}$	[V]	39.69
Result	Diode RMS current		I_{S2RMS}	[A]	0.56
Input	Max. voltage undershoot at output capacitor		ΔV_{Out1}	[V]	0.1
Input	Number of clock periods		n_{cp2}		10
Result	Output capacitor ripple current	Eq. 076	$I_{Ripple2}$	[A]	0.48
Result	Calculated minimum output capacitor	Eq. 077	$C_{Out2Cal}$	[μ F]	462
Input	Select output capacitor value (C152)		C_{Out2}	[μ F]	470
Input	ESR (Z_{max}) value from datasheet at 100 kHz		R_{ESR2}	[Ω]	0.032
Input	Number of parallel capacitors		n_{CCout2}		1
Result	Zero frequency of output capacitor	Eq. 078	f_{zCOut2}	[kHz]	10.58
Result	First stage ripple voltage	Eq. 079	$V_{Ripple2}$	[V]	0.04
Input	Select LC filter inductor value (L151)		L_{out}	[μ H]	na
Result	Calculated LC filter capacitor	Eq. 080	C_{LCCal2}	[μ F]	na
Input	Select LC filter capacitor value (C153)		C_{LC2}	[μ F]	na
Result	LC filter frequency	Eq. 081	f_{LC2}	[kHz]	na
Result	Second stage ripple voltage	Eq. 082	$V_{2ndRipple2}$	[mV]	na

V_{CC} diode and capacitor

V_{CC} diode and capacitor

Result	Auxiliary diode reverse voltage (D2)	Eq. 083	$V_{RDiodeVCC}$	[V]	95.55
Input	Soft-start time from datasheet		t_{ss}	[ms]	12
Input	$I_{VCC_charge3}$ from datasheet		$I_{VCC_charge3}$	[mA]	3
Input	V _{CC} on-threshold		V_{VCC_ON}	[V]	16
Input	V _{CC} off-threshold		V_{VCC_OFF}	[V]	10
Result	Calculated V _{CC} capacitor	Eq. 084	C_{VCCCal}	[μ F]	6.00
Input	Select V _{CC} capacitor (C3)		C_{VCC}	[μ F]	22
Input	V _{CC} short threshold from datasheet		V_{VCC_SCP}	[V]	1.1
Input	$I_{VCC_charge1}$ from datasheet		$I_{VCC_charge1}$	[mA]	0.2
Result	Start-up time	Eq. 085	$t_{StartUp}$	[ms]	230.267

Calculation of losses

Input diode bridge

Input	Diode bridge forward voltage		V_{FBR}	[V]	1
Result	Diode bridge power loss	Eq. 086	P_{DIN}	[W]	1.04

22 W auxiliary power supply for indoor air-conditioner using ICE5BR2280BZ



Appendix A: Transformer design and spreadsheet [3]

Transformer copper

Result	Primary winding copper resistance	Eq. 087	R_{PCu}	[m Ω]	607.52
Result	Secondary 1 winding copper resistance	Eq. 088	R_{S1Cu}	[m Ω]	16.63
Result	Secondary 2 winding copper resistance	Eq. 089	R_{S2Cu}	[m Ω]	20.79
Result	Primary winding copper loss	Eq. 090	P_{PCu}	[mW]	126.94
Result	Secondary 1 winding copper loss	Eq. 091	P_{S1Cu}	[mW]	114.95
Result	Secondary 2 winding copper loss	Eq. 092	P_{S2Cu}	[mW]	6.60
Result	Total transformer copper loss	Eq. 093	P_{Cu}	[W]	0.2485

Output rectifier diode

Result	Secondary 1 diode loss	Eq. 094	P_{Diode1}	[W]	1.58
Result	Secondary 2 diode loss	Eq. 095	P_{Diode2}	[W]	0.11

RCD clamper circuit

Result	RCD clamper loss	Eq. 096	$P_{Clamper}$	[W]	0.74
--------	------------------	---------	---------------	-----	------

Current sense resistor

Result	Current sense resistor loss	Eq. 097	P_{CS}	[W]	0.15
--------	-----------------------------	---------	----------	-----	------

MOSFET

Input	$R_{DS(on)}$ from datasheet		$R_{DS(on)}$ at $T_A = 125^\circ\text{C}$	[Ω]	4.31
Input	$C_{o(er)}$ from datasheet		$C_{o(er)}$	[pF]	7
Input	External drain-to-source capacitance		C_{DS}	[pF]	0
Result	Switch-on loss at minimum AC input voltage	Eq. 098	$P_{SONMinAC}$	[W]	0.0080
Result	Conduction loss at minimum AC input voltage	Eq. 099	$P_{condMinAC}$	[W]	0.9005
Result	Total MOSFET loss at minimum AC input voltage	Eq. 100	$P_{MOSMinAC}$	[W]	0.9086
Result	Switch-on loss at maximum AC input voltage	Eq. 101	$P_{SONMaxAC}$	[W]	0.0491
Result	Conduction loss at maximum AC input voltage	Eq. 102	$P_{condMaxAC}$	[W]	0.2324
Result	Total MOSFET loss at maximum AC input voltage	Eq. 103	$P_{MOSMaxAC}$	[W]	0.2815
Result	Total MOSFET loss (from minimum or maximum AC)		P_{MOS}	[W]	0.9086

Controller

Input	Controller current consumption		I_{VCC_Normal}	[mA]	5.0
Result	Controller loss	Eq. 104	P_{Ctrl}	[W]	0.0915

Efficiency after losses

Result	Total power loss	Eq. 105	P_{Losses}	[W]	4.86
Result	Post calculated efficiency	Eq. 106	η_{Post}	%	81.90%

CoolSET™/MOSFET temperature

CoolSET™/MOSFET temperature

Input	Enter thermal resistance junction-ambient (include copper pour)		R_{thJA_As}	[°K/W]	65.0
Result	Temperature rise	Eq. 107	ΔT	[°K]	59.1
Result	Junction temperature at T_{amax}	Eq. 108	T_{jmax}	°C	109.1

Appendix A: Transformer design and spreadsheet [3]

Output regulation (isolated using TL431 and optocoupler)

Isolated feedback circuit

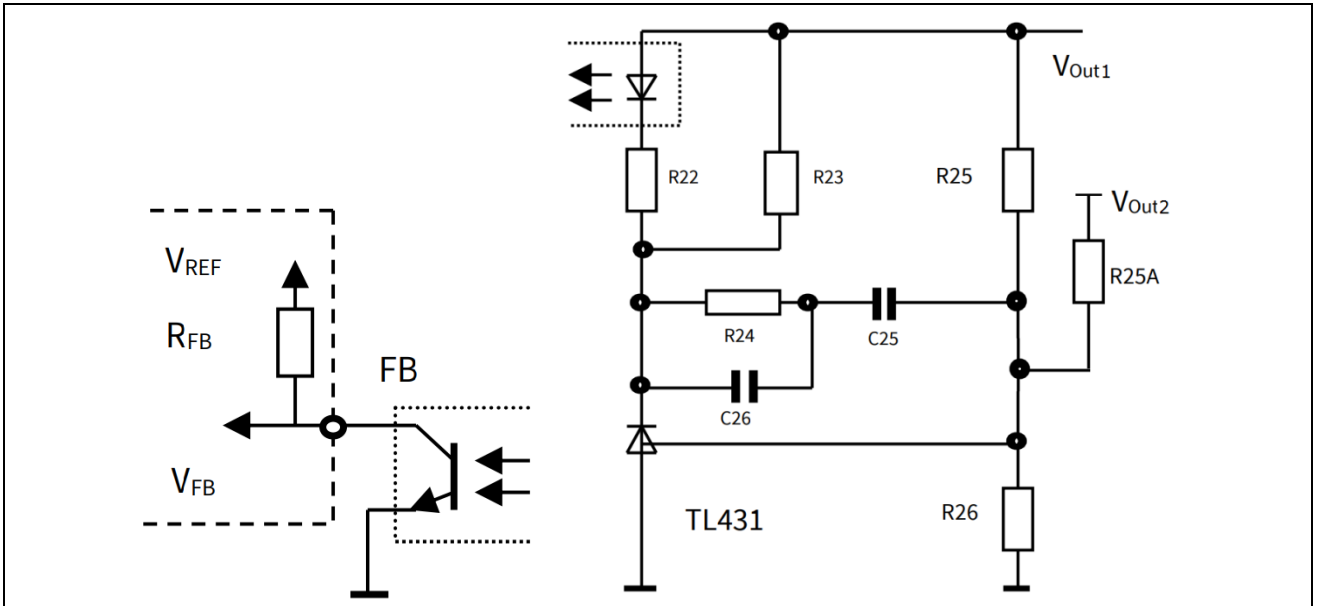

Output regulation

Input	TL431 reference voltage		V_{REF_TL}	[V]	2.5
Input	Weighted regulation factor of V_{Out1}		W_1		1
Input	Current for voltage divider resistor R26		I_{R26}	[mA]	0.25
Result	Calculated voltage divider resistor	Eq. 111	$R26_{cal}$	[k Ω]	10
Input	Select voltage divider resistor value		R26	[k Ω]	10
Result	Calculated voltage divider resistor	Eq. 112	$R25_{cal}$	[k Ω]	38.00
Input	Select voltage divider resistor value		R25	[k Ω]	38.0
Result	Calculated voltage divider resistor	Eq. 113	$R25A_{cal}$	[k Ω]	na
Input	Select voltage divider resistor value		R25A	[k Ω]	na

Optocoupler and TL431 bias

Input	Current transfer ratio (CTR)		G_C	[%]	200%
Input	Optocoupler diode forward voltage		V_{FOpto}	[V]	1.25
Input	Maximum current for optocoupler diode		I_{Fmax}	[mA]	50
Input	Minimum current for TL431		I_{KAmin}	[mA]	1
Result	Calculated minimum optocoupler bias resistance	Eq. 114	$R22_{cal}$	[k Ω]	0.1650
Input	Select optocoupler bias resistor		R22	[k Ω]	1
Input	FB pull-up reference voltage V_{REF} from datasheet		V_{REF}	[V]	3.3
Input	V_{FB_OLP} from datasheet		V_{FB_OLP}	[V]	2.75
Input	R_{FB} from datasheet		R_{FB}	[k Ω]	15
Result	Calculated maximum TL431 bias resistance	Eq. 115	$R23_{cal}$	[k Ω]	1.27
Input	Selected TL431 bias resistor		R23	[k Ω]	1

Regulation loop

Result	Feedback transfer characteristic	Eq. 116	K_{FB}		30.00
Result	Gain of feedback transfer characteristic	Eq. 117	G_{FB}	[db]	29.54
Result	Voltage divider transfer characteristic	Eq. 118	K_{VD}		0.208333
Result	Gain of voltage divider transfer characteristic	Eq. 119	G_{VD}	[db]	-13.62
Result	Resistance at maximum load pole	Eq. 120	R_{LH}	[Ω]	6.55
Result	Resistance at minimum load pole	Eq. 121	R_{LL}	[Ω]	48.00
Result	Poles of power stage at maximum load pole	Eq. 122	f_{OH}	[Hz]	86.84
Result	Poles of power stage at minimum load pole	Eq. 123	f_{OL}	[Hz]	11.84
Result	Zero frequency of the compensation network	Eq. 124	f_{OM}	[Hz]	32.07

22 W auxiliary power supply for indoor air-conditioner using ICE5BR2280BZ



Appendix A: Transformer design and spreadsheet [3]

Input	Zero dB crossover frequency		f_g	[kHz]	3
Input	PWM-OP gain from datasheet		A_v		2.03
Result	Transient impedance	Eq. 117	Z_{PWM}	[V/A]	1.8
Result	Power stage at crossover frequency	Eq. 118	$ F_{PWR}(f_g) $		0.171
Result	Gain of power stage at crossover frequency	Eq. 119	$G_{PWR}(f_g)$	[db]	-15.34
Result	Gain of the regulation loop at f_g	Eq. 120	$G_S(\omega)$	[db]	0.580
Result	Separated components of the regulator	Eq. 121	$G_r(\omega)$	[db]	-0.580
Result	Calculated resistance value of compensation network	Eq. 122	$R_{24_{cal}}$	[k Ω]	7.41
Input	Select resistor value of compensation network		R_{24}	[k Ω]	22
Result	Calculated capacitance value of compensation network	Eq. 123	$C_{26_{cal}}$	[nF]	2.411
Input	Select capacitor value of compensation network		C_{26}	[nF]	0.68
Result	Calculated capacitance value of compensation network	Eq. 124	$C_{25_{cal}}$	[nF]	224.91
Input	Select capacitor value of compensation network		C_{25}	[nF]	220

Final design

Electrical

Minimum AC voltage		[V]	85
Maximum AC voltage		[V]	264
Maximum input current		[A]	0.31
Minimum DC voltage		[V]	96
Maximum DC voltage		[V]	373
Maximum output power		[W]	22.0
Output voltage 1		[V]	12.0
Output ripple voltage 1		[mV]	1.2
Output voltage 2		[V]	7.5
Output ripple voltage 2		[mV]	na
Transformer peak current		[A]	1.14
Maximum duty cycle			0.49
Reflected voltage		[V]	91
Copper losses		[W]	0.25
MOSFET losses		[W]	0.91
Sum losses		[W]	4.86
Efficiency		[%]	81.90%

Transformer

Core type			E25/13/7
Core material			N87
Effective core area		[mm ²]	52
Maximum flux density		[mT]	237
Inductance		[μ H]	628
Margin		[mm]	0
Primary turns		Turns	58
Primary copper wire size		AWG	28
Number of primary copper wires in parallel			1
Primary layers		Layer	2
Secondary 1 turns(N_{S1})		Turns	8
Secondary 1 copper wire size		AWG	24
Number of secondary 1 copper wires in parallel			2
Secondary 1 layers		Layer	1
Secondary 2 turns (N_{S2})		Turns	5
Secondary 2 copper wire size		AWG	24
Number of secondary 2 copper wires in parallel			1
Secondary 2 layers		Layer	1
Auxiliary turns		Turns	12
Leakage inductance		[μ H]	12.6

Components

Input capacitor (C1)		[μ F]	68.0
Secondary 1 output capacitor (C152)		[μ F]	560.0
Secondary 1 output capacitor in parallel			1.0

22 W auxiliary power supply for indoor air-conditioner using ICE5BR2280BZ



Appendix A: Transformer design and spreadsheet [3]

Secondary 1 LC filter inductor (L151)			[μ H]	4.7
Secondary 1 LC filter capacitor (C153)			[μ F]	220.0
Secondary 2 output capacitor (C102)			[μ F]	470.0
Secondary 2 output capacitor in parallel				1.0
Secondary 2 LC filter inductor (L101)			[μ H]	na
Secondary 2 LC filter capacitor (C103)			[μ F]	na
V _{CC} capacitor (C3)			[μ F]	22.0
Sense resistor (R8A, R8B)			[Ω]	0.70
Clamping resistor (R4)			[k Ω]	240.0
Clamping capacitor (C2)			[nF]	1
Input capacitor (C1)			[μ F]	68.0
Secondary 1 output capacitor (C152)			[μ F]	560.0

Regulation components (isolated using TL431 and optocoupler)

Voltage divider		R26	[k Ω]	10.0
Voltage divider (V _{O1} sense)		R25	[k Ω]	38.0
Voltage divider (V _{O2} sense)		R25A	[k Ω]	na
Optocoupler bias resistor		R22	[k Ω]	1.00
TL431 bias resistor		R23	[k Ω]	1.0
Compensation network resistor		R24	[k Ω]	22.0
Compensation network capacitor		C26	[nF]	0.68
Compensation network capacitor		C25	[nF]	220.0

22 W auxiliary power supply for indoor air-conditioner using ICE5BR2280BZ



Appendix B: WE transformer specification

12 Appendix B: WE transformer specification

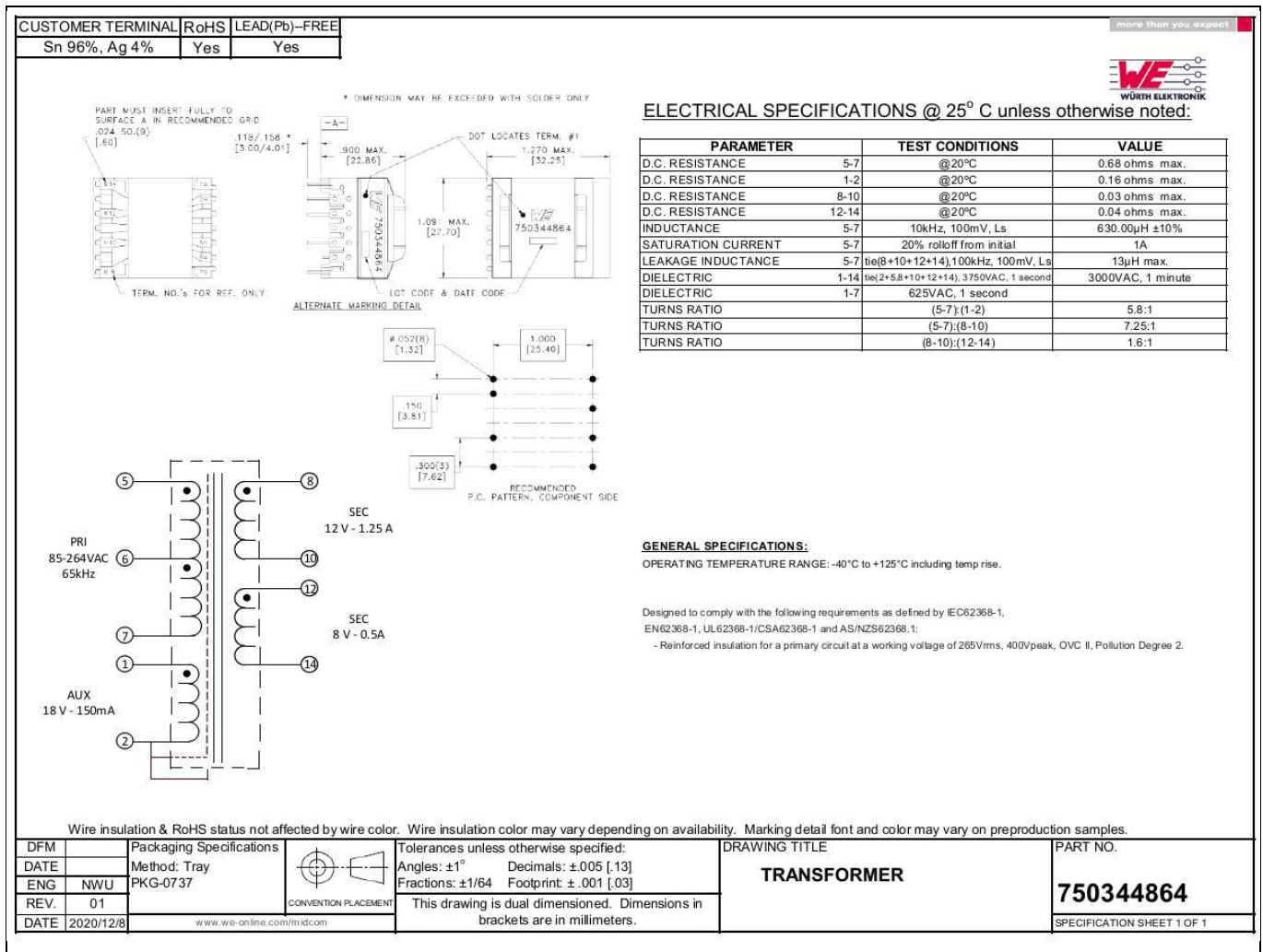

Figure 31 WE transformer specification

13 References

- [1] Infineon Technologies AG: ICE5BR2280BZ Datasheet (V 1.0); 2022-02-22; [ICE5BR2280BZ Datasheet](#)
- [2] Infineon Technologies AG: Fifth-generation fixed-frequency design guide (V 1.1); 2019-07-24; [Fifth-generation fixed-frequency design guide](#)
- [3] Infineon Technologies AG: Calculation tool for fixed-frequency flyback converter using fifth-generation CoolSET™ (V 1.1); 2018-02-26; [Calculation tool fixed-frequency CoolSET™ 5th generation](#)

Revision history

Revision history

Document version	Date of release	Description of changes
V 1.0	2022-06-15	First release

Trademarks

All referenced product or service names and trademarks are the property of their respective owners.

Edition 2022-06-15

Published by

Infineon Technologies AG

81726 Munich, Germany

© 2022 Infineon Technologies AG.

All Rights Reserved.

Do you have a question about this document?

Email: erratum@infineon.com

Document reference

AN_2101_PL21_2105_101648

IMPORTANT NOTICE

The information contained in this application note is given as a hint for the implementation of the product only and shall in no event be regarded as a description or warranty of a certain functionality, condition or quality of the product. Before implementation of the product, the recipient of this application note must verify any function and other technical information given herein in the real application. Infineon Technologies hereby disclaims any and all warranties and liabilities of any kind (including without limitation warranties of non-infringement of intellectual property rights of any third party) with respect to any and all information given in this application note.

The data contained in this document is exclusively intended for technically trained staff. It is the responsibility of customer's technical departments to evaluate the suitability of the product for the intended application and the completeness of the product information given in this document with respect to such application.

For further information on the product, technology, delivery terms and conditions and prices please contact your nearest Infineon Technologies office (www.infineon.com).

WARNINGS

Due to technical requirements products may contain dangerous substances. For information on the types in question please contact your nearest Infineon Technologies office.

Except as otherwise explicitly approved by Infineon Technologies in a written document signed by authorized representatives of Infineon Technologies, Infineon Technologies' products may not be used in any applications where a failure of the product or any consequences of the use thereof can reasonably be expected to result in personal injury.