



# IR Emitter and Detector Product Data Sheet

LTR-536AB

Spec No.: DS50-2000-007

Effective Date: 05/18/2010

Revision: A

**LITE-ON DCC**

**RELEASE**

BNS-OD-FC001/A4

**FEATURES**

- \* HIGH PHOTO SENSITIVITY
- \* SUITABLE FOR INFRARED RADIATION
- \* LOW JUNCTION CAPACITANCE
- \* HIGH CUT-OFF FREQUENCY
- \* FAST SWITCHING TIME
- \* THE LTR-536AB IS A SPECIAL DARK BLUE PLASTIC PACKAGE THAT CUT THE VISIBLE LIGHT AND SUITABLE FOR THE DETECTORS OF INFRARED APPLICATIONS

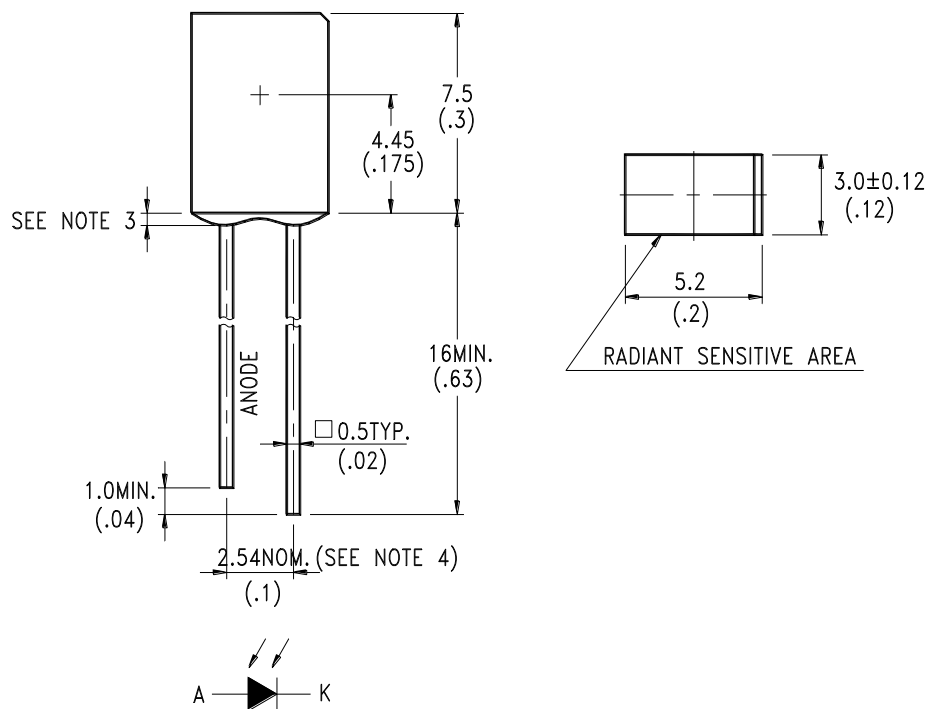
**PACKAGE DIMENSIONS****NOTES:**

1. All dimensions are in millimeters (inches).
2. Tolerance is  $\pm 0.25\text{mm}(.010\text{'})$  unless otherwise noted.
3. Protruded resin under flange is  $1.5\text{mm}(.059\text{'})$  max.
4. Lead spacing is measured where the leads emerge from the package.
5. Specifications are subject to change without notice.



# LITE-ON TECHNOLOGY CORPORATION.

Property of Lite-On Only

## ABSOLUTE MAXIMUM RATINGS AT TA=25°C

PARAMETER	MAXIMUM RATING	UNIT
Power Dissipation	150	mW
Reverse Voltage	30	V
Operating Temperature Range	-40°C to + 85°C	
Storage Temperature Range	-55°C to + 100°C	
Lead Soldering Temperature [1.6mm(.063") From Body]	260°C for 5 Seconds	

## ELECTRICAL OPTICAL CHARACTERISTICS AT TA=25°C

PARAMETER	SYMBOL	MIN.	TYP.	MAX.	UNIT	TEST CONDITION
Reverse Break Down Voltage	V <sub>(BR)R</sub>	30			V	I <sub>R</sub> = 100 μA E <sub>e</sub> = 0mW/cm <sup>2</sup>
Reverse Dark Current Voltage	I <sub>D(R)</sub>			30	nA	V <sub>R</sub> = 10V E <sub>e</sub> = 0mW/cm <sup>2</sup>
Open Circuit Voltage	V <sub>OC</sub>		350		mV	λ = 940nm E <sub>e</sub> = 0.5mW/cm <sup>2</sup>
Rise Time	T <sub>r</sub>		50		nsec	V <sub>R</sub> = 10V λ = 940nm R <sub>L</sub> = 1KΩ
Fall Time	T <sub>f</sub>		50		nsec	
Short Circuit Current	I <sub>S</sub>	1.7	2		μA	V <sub>R</sub> = 5V λ = 940nm E <sub>e</sub> = 0.1mW/cm <sup>2</sup>
Total Capacitance	C <sub>T</sub>		25		P	V <sub>R</sub> = 3V f = 1MHZ E <sub>e</sub> = 0mW/cm <sup>2</sup>
Wavelength of the Max Sensitivity	λ <sub>S MAX</sub>		900		nm	

## TYPICAL ELECTRICAL / OPTICAL CHARACTERISTICS CURVES

(25°C Ambient Temperature Unless Otherwise Noted)

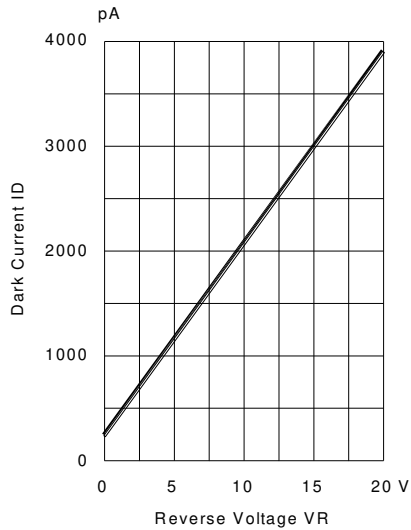

Fig.1 DARK CURRENT VS. REVERSE VOLTAGE  
TA=25° C, Ee=0mW/cm<sup>2</sup>

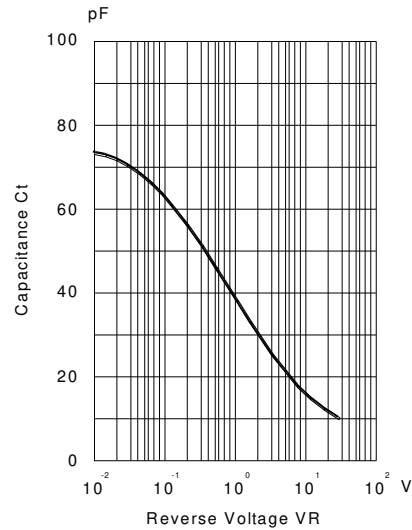

Fig.2 CAPACITANCE VS. REVERSE VOLTAGE  
F=1MHZ; Ee=0mW/cm<sup>2</sup>

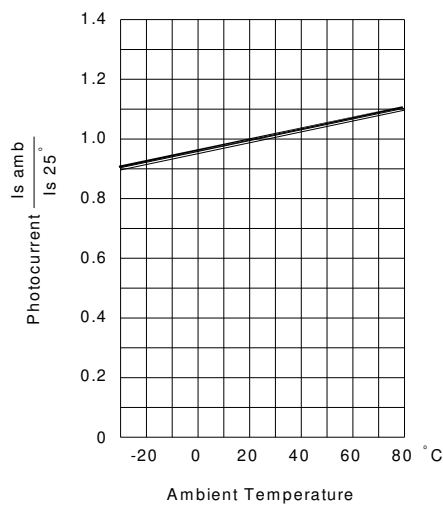

Fig.3 PHOTOCURRENT VS. AMBIENT TEMPERATURE

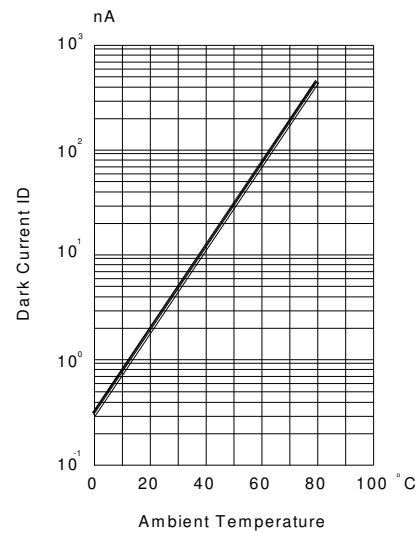

Fig.4 DARK CURRENT VS. AMBIENT TEMPERATURE  
VR=10, Ee=0mW/cm<sup>2</sup>

## TYPICAL ELECTRICAL / OPTICAL CHARACTERISTICS CURVES

(25°C Ambient Temperature Unless Otherwise Noted)

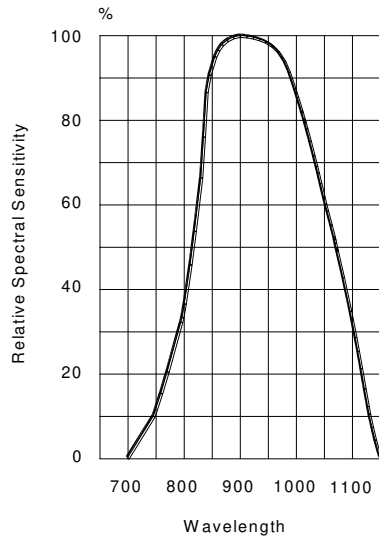

Fig.5 RELATIVE SPECTRAL SENSITIVITY VS WAVELENGTH

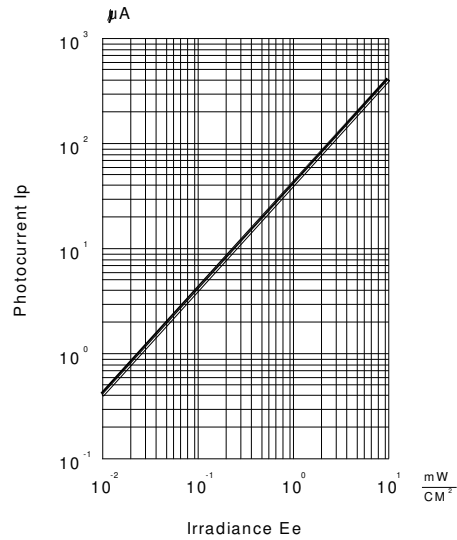

Fig.6 PHOTOCURRENT VS IRRADIANCE  $\lambda= 940$  nm

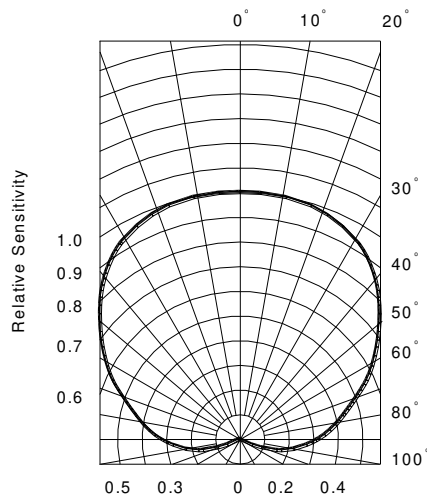

Fig.7 SENSITIVITY DIAGRAM

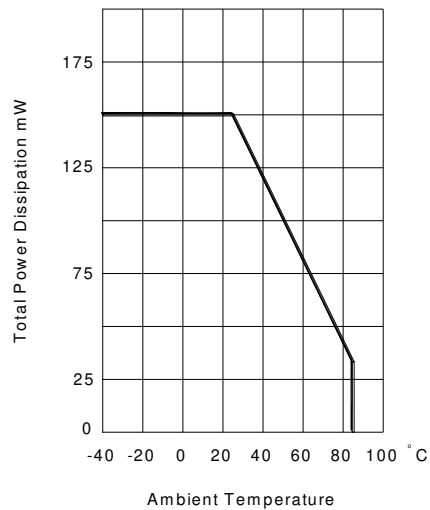

Fig.8 TOTAL POWER DISSIPATION VS AMBIENT TEMPERATURE