

TL30F Flat-Mount Tower Light



Datasheet

Multi-Color, General-Purpose Indicators



- Rugged, cost-effective and easy-to-install multi-segment indicators
- Illuminated segments provide easy-to-see operator guidance and indication of equipment status
- Displays up to 5 colors
- Compact devices are completely self-contained — no controller needed
- Immune to ambient light, EMI and RFI interference
- Bimodal input
- 18 V dc to 30 V dc or 21 V ac to 27 V ac operation
- No assembly required

Models

Model	Color Count	Connection ¹	LED Color ²	Input
TL30FGYR	3	2 m (6.5 ft) integral cable	3 Color: Green, Yellow, Red	Bimodal (NPN or PNP)
TL30FGYRQ		4-pin M12/ Euro-style integral QD connector		
TL30FWBGYR	5	2 m (6.5 ft) integral cable	5 Color: White, Blue, Green, Yellow, Red	
TL30FWBGYRQ		8-pin M12/ Euro-style integral QD connector		

Wiring – 3-Color Models

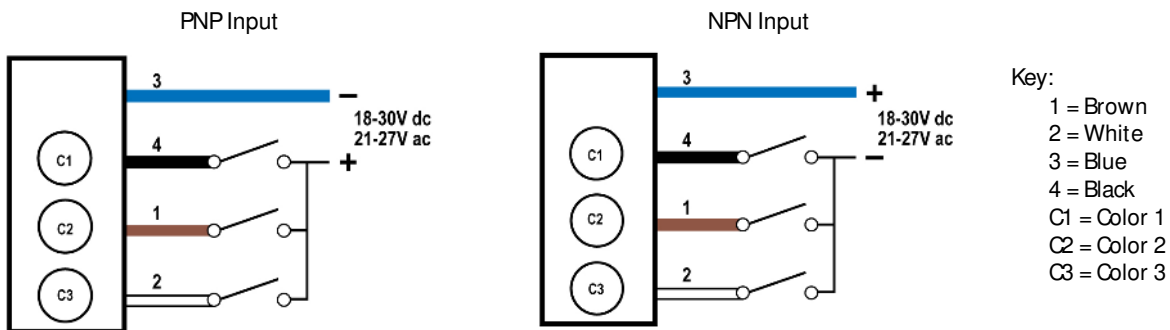

¹ Models with a quick disconnect require a mating cordset.

² The first color listed is the bottom color, going up in successive order. Contact Banner Engineering for other colors and color combinations.



Wiring – 5-Color Models

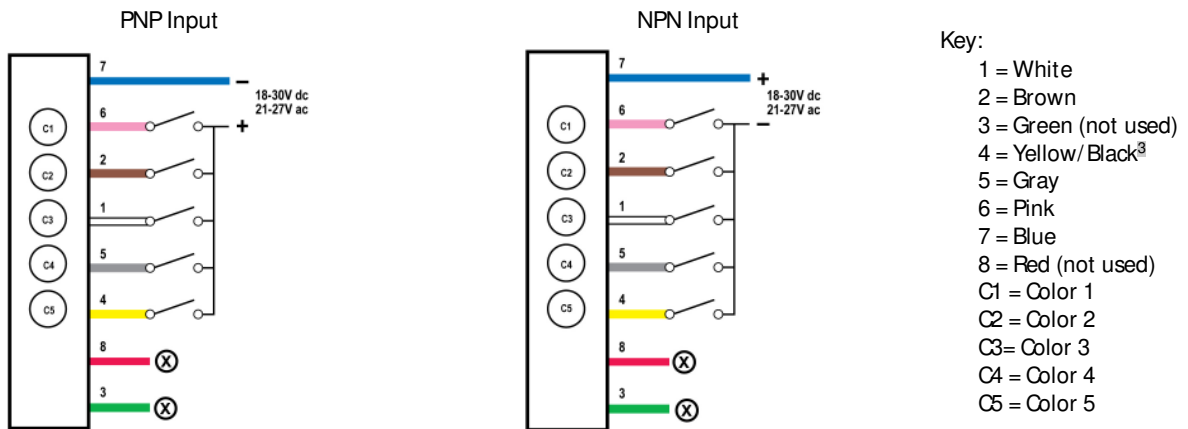

Specifications

Supply Voltage and Current

18 V dc to 30 V dc (10% max. ripple) or 21 V ac to 27 V ac at 18 mA max. per LED color

Indicators

LEDs are independently selected: Green, Red, Yellow, Blue, or White; 3 or 5 colors, depending on model.

Input Response Time

Indicator ON/OFF: 1 ms max.

Construction

Black painted aluminum housing; thermoplastic end caps; acrylic light bar

Connections

Integral 4-pin or 8-pin M12/Euro-style QD, or 2 m (6.5 ft) integral cable, depending on model

Environmental Rating

IEC IP65

Operating Conditions

-40 °C to +50 °C (-40 °F to +122 °F)

Certifications



Dimensions

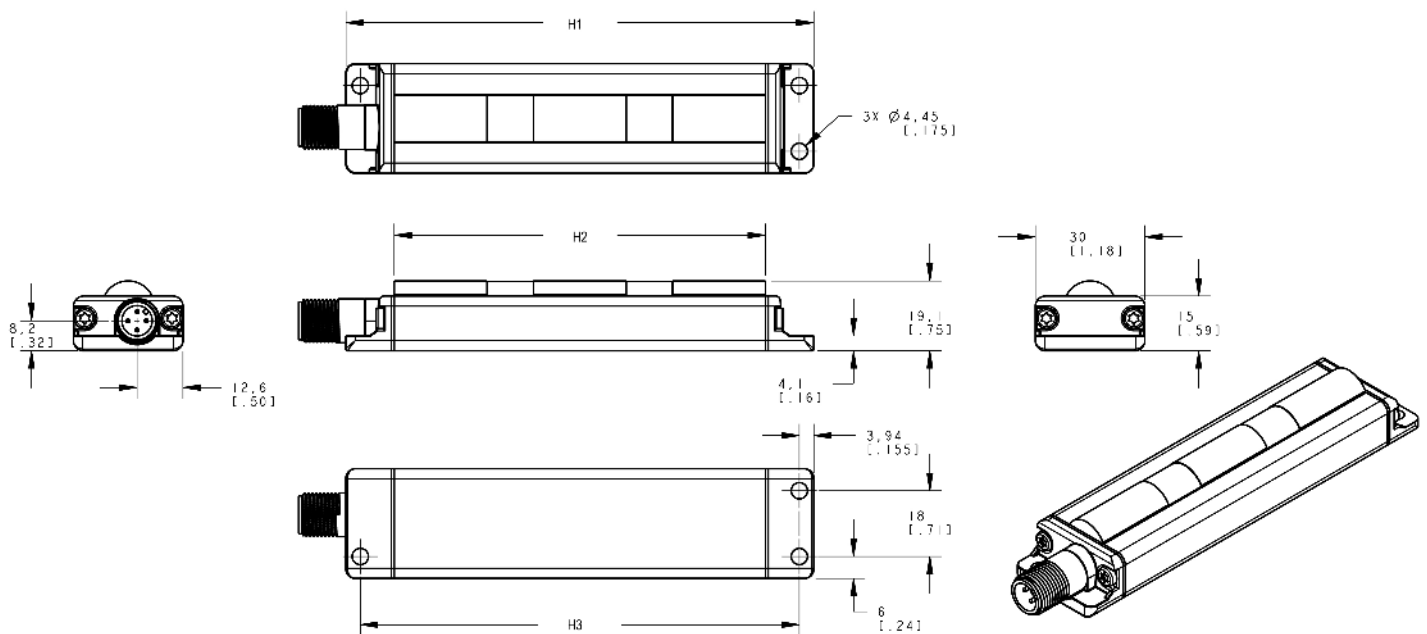

[§] Integral cable models use black wire; QD models use yellow wire.

Tower Height (H...)		
	3-Color Models	5-Color Models
H1	128.1 mm (5.04 in)	204.3 mm (8.04 in)
H2	101.6 mm (4.0 in)	177.8 mm (7.00 in)
H3	120.2 mm (4.73 in)	196.4 mm (7.73 in)

Accessories

4-Pin Euro-Style Cordsets

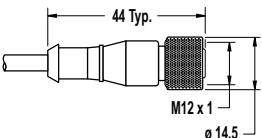
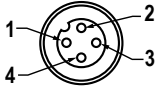
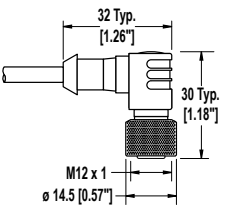
4-Pin Threaded M12/Euro-Style Cordsets				
Model	Length	Style	Dimensions	Pinout (Female)
MQDC-406	1.83 m (6 ft)	Straight		 <p>1 = Brown 2 = White 3 = Blue 4 = Black</p>
MQDC-415	4.57 m (15 ft)			
MQDC-430	9.14 m (30 ft)			
MQDC-450	15.2 m (50 ft)			
MQDC-406RA	1.83 m (6 ft)	Right-Angle		
MQDC-415RA	4.57 m (15 ft)			
MQDC-430RA	9.14 m (30 ft)			
MQDC-450RA	15.2 m (50 ft)			

8-pin Euro-Style Cordsets

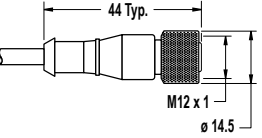
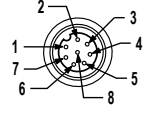
8-Pin Threaded M12/Euro-Style Cordsets with Open-Shield				
Model	Length	Style	Dimensions	Pinout (Female)
MQDC2S-806	1.83 m (6 ft)	Straight		 <p>1 = White 5 = Gray 2 = Brown 6 = Pink 3 = Green 7 = Blue 4 = Yellow 8 = Red</p>
MQDC2S-815	4.57 m (15 ft)			
MQDC2S-830	9.14 m (30 ft)			
MQDC2S-850	15.2 m (50 ft)			

Mounting Brackets

SMBPVA1

- Right-angle bracket
- Clearance for M4 (#10) hardware
- 303 stainless steel



SMBPVA2

- Set of 4 molded brackets
- Snaps onto standard 28 mm (1.1 in) diameter pipe
- 2 required per sensor



SMBPVA11

- Pair of two-piece swivel brackets for mounting indicator to 8 mm (5/16 in) metal rack system
- Articulation slot for $\pm 90^\circ$ rotation



SMBPVA6

- Set of 4 molded brackets
- Snaps onto standard 28 mm (1.1 in) diameter pipe
- 2 required per sensor



SMBPVA9

- Pair of two-piece swivel brackets
- Mount directly to sensor or to PVD or PVA protective brackets
- Designed for mounting sensor to "look down"



Banner Engineering Corp. Limited Warranty

Banner Engineering Corp. warrants its products to be free from defects in material and workmanship for one year following the date of shipment. Banner Engineering Corp. will repair or replace, free of charge, any product of its manufacture which, at the time it is returned to the factory, is found to have been defective during the warranty period. This warranty does not cover damage or liability for misuse, abuse, or the improper application or installation of the Banner product.

THIS LIMITED WARRANTY IS EXCLUSIVE AND IN LIEU OF ALL OTHER WARRANTIES WHETHER EXPRESS OR IMPLIED (INCLUDING, WITHOUT LIMITATION, ANY WARRANTY OF MERCHANTABILITY OR FITNESS FOR A PARTICULAR PURPOSE), AND WHETHER ARISING UNDER COURSE OF PERFORMANCE, COURSE OF DEALING OR TRADE USAGE.

This Warranty is exclusive and limited to repair or, at the discretion of Banner Engineering Corp., replacement. IN NO EVENT SHALL BANNER ENGINEERING CORP. BE LIABLE TO BUYER OR ANY OTHER PERSON OR ENTITY FOR ANY EXTRA COSTS, EXPENSES, LOSSES, LOSS OF PROFITS, OR ANY INCIDENTAL, CONSEQUENTIAL OR SPECIAL DAMAGES RESULTING FROM ANY PRODUCT DEFECT OR FROM THE USE OR INABILITY TO USE THE PRODUCT, WHETHER ARISING IN CONTRACT OR WARRANTY, STATUTE, TORT, STRICT LIABILITY, NEGLIGENCE, OR OTHERWISE.

Banner Engineering Corp. reserves the right to change, modify or improve the design of the product without assuming any obligations or liabilities relating to any product previously manufactured by Banner Engineering Corp. Any misuse, abuse, or improper application or installation of this product or use of the product for personal protection applications when the product is identified as not intended for such purposes will void the product warranty. Any modifications to this product without prior express approval by Banner Engineering Corp will void the product warranties. All specifications published in this document are subject to change; Banner reserves the right to modify product specifications or update documentation at any time. Specifications and product information in English supersede that which is provided in any other language. For the most recent version of any documentation, refer to:

www.bannerengineering.com.