

### DESCRIPTION

The MP4420H is a high-frequency, synchronous, rectified, step-down, switch-mode converter with built-in power MOSFETs. It offers a very compact solution to achieve a 2A continuous output current with excellent load and line regulation over a wide input supply range. The MP4420H has synchronous mode operation for higher efficiency over the output current load range.

Current-mode operation provides fast transient response and eases loop stabilization.

Full protection features include over-current protection and thermal shut down.

The MP4420H requires a minimal number of readily-available standard external components, and is available in a space-saving TSOT23-8 package.

### FEATURES

- Wide 4V to 36V Continuous Operating Input Range
- 90mΩ/55mΩ Low  $R_{DS(ON)}$  Internal Power MOSFETs
- High-Efficiency Synchronous Mode Operation
- Default 410kHz Switching Frequency
- Synchronizes to a 200kHz to 2.2MHz External Clock
- High Duty Cycle for Automotive Cold-crank
- Power-Save Mode
- Internal Soft-Start
- Power Good
- OCP Protection and Hiccup
- Thermal Shutdown
- Output Adjustable from 0.8V
- Available in an 8-pin TSOT23-8 package

### APPLICATIONS

- Automotive
- Industrial Control System
- Distributed Power Systems

All MPS parts are lead-free and adhere to the RoHS directive. For MPS green status, please visit MPS website under Quality Assurance. "MPS" and "The Future of Analog IC Technology" are Registered Trademarks of Monolithic Power Systems, Inc.

### TYPICAL APPLICATION

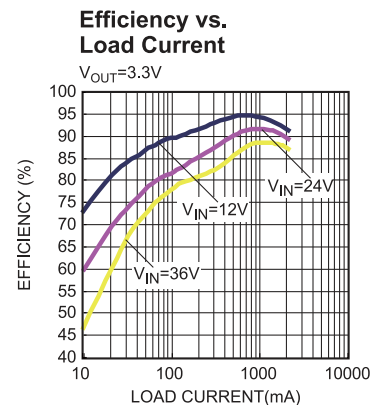
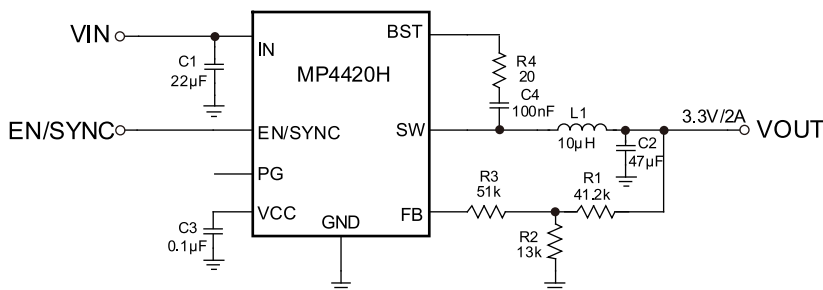

### ORDERING INFORMATION

Part Number*	Package	Top Marking
MP4420HGJ	TSOT23-8	See Below

\* For Tape & Reel, add suffix -Z (e.g. MP4420HGJ-Z)

### TOP MARKING

| **ALMY**

ALM: product code of MP4420HGJ;  
 Y: year code;

### PACKAGE REFERENCE

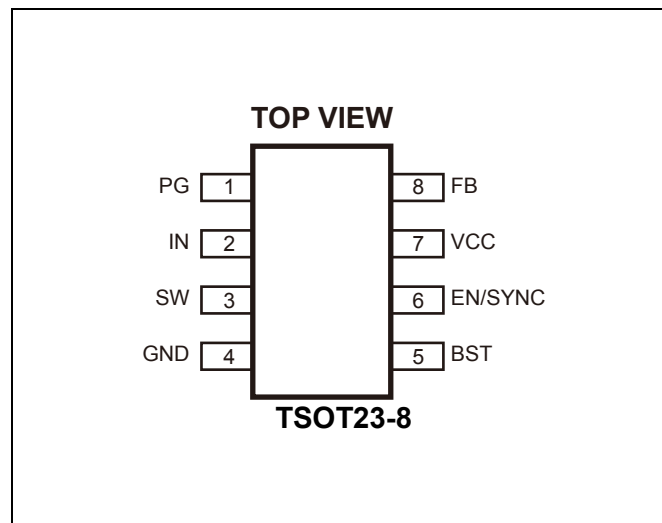

**ABSOLUTE MAXIMUM RATINGS <sup>(1)</sup>**

$V_{IN}$ .....	-0.3V to 40V
$V_{SW}$ .....	-0.3V to 41V
$V_{BS}$ .....	$V_{SW}+6V$
All Other Pins.....	-0.3V to 6V <sup>(2)</sup>
<b>Continuous Power Dissipation (<math>T_A = +25^\circ C</math>) <sup>(3)</sup></b>	
TSOT23-8.....	1.25W
Junction Temperature.....	150°C
Lead Temperature .....	260°C
Storage Temperature.....	-65°C to 150°C

**Recommended Operating Conditions**

Continuous Supply Voltage $V_{IN}$ .....	4V to 36V
Output Voltage $V_{OUT}$ .....	0.8V to 0.9 $\times V_{IN}$
Operating Junction Temp. ( $T_J$ ). -40°C to +125°C	

<b>Thermal Resistance <sup>(4)</sup></b>	<b><math>\theta_{JA}</math></b>	<b><math>\theta_{JC}</math></b>	
TSOT23-8 .....	100 .....	55 ...	°C/W

**Notes:**

- 1) Absolute maximum ratings are rated under room temperature unless otherwise noted. Exceeding these ratings may damage the device.
- 2) About the details of EN pin's ABS MAX rating, please refer to page 14, Enable/SYNC Control section.
- 3) The maximum allowable power dissipation is a function of the maximum junction temperature  $T_J$  (MAX), the junction-to-ambient thermal resistance  $\theta_{JA}$ , and the ambient temperature  $T_A$ . The maximum allowable continuous power dissipation at any ambient temperature is calculated by  $P_D$  (MAX) =  $(T_J$  (MAX)- $T_A$ )/ $\theta_{JA}$ . Exceeding the maximum allowable power dissipation will cause excessive die temperature, and the regulator will go into thermal shutdown. Internal thermal shutdown circuitry protects the device from permanent damage.
- 4) Measured on JESD51-7, 4-layer PCB.

**ELECTRICAL CHARACTERISTICS**
 **$V_{IN} = 12V$ ,  $T_J = +25^{\circ}C$ , unless otherwise noted.**

Parameter	Symbol	Condition	Min	Typ	Max	Units
Supply Current (Shutdown)	$I_{SHDN}$	$V_{EN} = 0V$			8	$\mu A$
Supply Current (Quiescent)	$I_Q$	$V_{EN} = 2V$ , $V_{FB} = 1V$		0.5	0.7	mA
HS Switch-ON Resistance	$R_{ON\_HS}$	$V_{BST-SW}=5V$		90	105	m $\Omega$
LS Switch-ON Resistance	$R_{ON\_LS}$	$V_{CC} = 5V$		55	75	m $\Omega$
Switch Leakage	$I_{LKG\_SW}$	$V_{EN} = 0V$ , $V_{SW} = 12V$			1	$\mu A$
Current Limit	$I_{LIMIT}$	Under 40% Duty Cycle	3.2	4.2	5.3	A
Oscillator Frequency	$f_{SW}$	$V_{FB}=750mV$	320	410	500	kHz
Fold-Back Frequency	$f_{FB}$	$V_{FB}<400mV$	70	100	130	kHz
Maximum Duty Cycle	$D_{MAX}$	$V_{FB}=750mV$ , 410kHz	92	95		%
Minimum ON Time <sup>(5)</sup>	$t_{ON\_MIN}$			70		ns
Sync Frequency Range	$f_{SYNC}$		0.2		2.4	MHz
Feedback Voltage	$V_{FB}$		780	792	804	mV
Feedback Current	$I_{FB}$	$V_{FB}=820mV$		10	100	nA
EN Rising Threshold	$V_{EN\_RISING}$		1.15	1.4	1.65	V
EN Falling Threshold	$V_{EN\_FALLING}$		1.05	1.25	1.45	V
EN Threshold Hysteresis	$V_{EN\_HYS}$			150		mV
EN Input Current	$I_{EN}$	$V_{EN}=2V$		4	6	$\mu A$
		$V_{EN}=0$		0	0.2	$\mu A$
VIN Under-Voltage Lockout Threshold-Rising	$INUV_{RISING}$		3.3	3.5	3.7	V
VIN Under-Voltage Lockout Threshold-Falling	$INUV_{FALLING}$		3.1	3.3	3.5	V
VIN Under-Voltage Lockout Threshold-Hysteresis	$INUV_{HYS}$			200		mV
VCC Regulator	$V_{CC}$	$I_{CC}=0mA$	4.6	4.9	5.2	V
VCC Load Regulation		$I_{CC}=5mA$		1.5	4	%
Soft-Start Period	$t_{SS}$	$V_{OUT}$ from 10% to 90%	0.55	1.45	2.45	ms
Thermal Shutdown <sup>(5)</sup>			150	170		$^{\circ}C$
Thermal Hysteresis <sup>(5)</sup>				30		$^{\circ}C$
PG Rising Threshold	$PG_{Vth\_RISING}$	as percentage of $V_{FB}$	86.5	90	93.5	%
PG Falling Threshold	$PG_{Vth\_FALLING}$	as percentage of $V_{FB}$	80.5	84	87.5	%

**ELECTRICAL CHARACTERISTICS (continued)**
 **$V_{IN} = 12V$ ,  $T_J = 25^{\circ}C$ , unless otherwise noted.**

Parameter	Symbol	Condition	Min	Typ	Max	Units
PG Threshold Hysteresis	$PG_{Vth\_HYS}$	as percentage of $V_{FB}$		6		%
PG Rising Delay	$PG_{Td\_RISING}$		40	90	160	$\mu s$
PG Falling Delay	$PG_{Td\_FALLING}$		30	55	95	$\mu s$
PG Sink Current Capability	$V_{PG}$	Sink 4mA		0.1	0.3	V
PG Leakage Current	$I_{LKG\_PG}$			10	100	nA

**Notes:**

5) Derived from bench characterization. Not tested in production

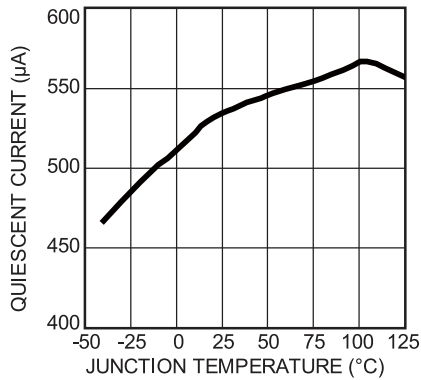
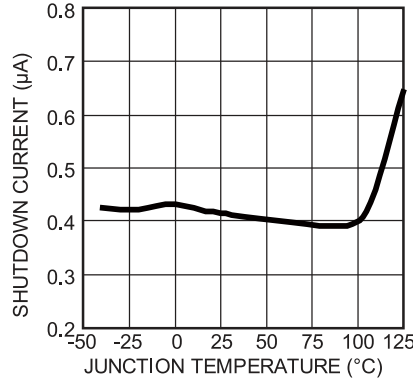
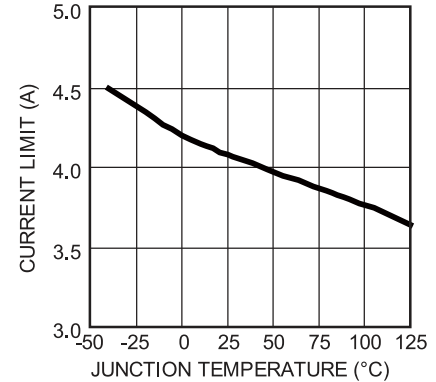
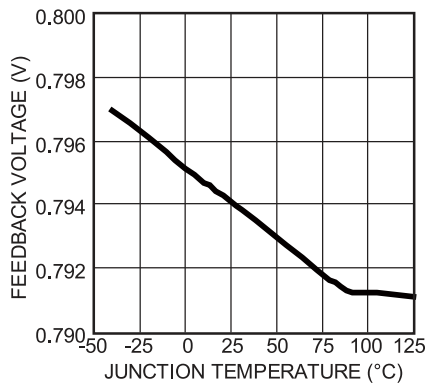
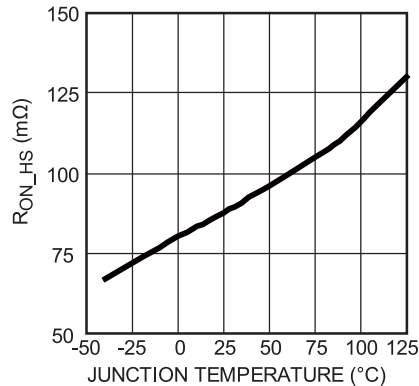
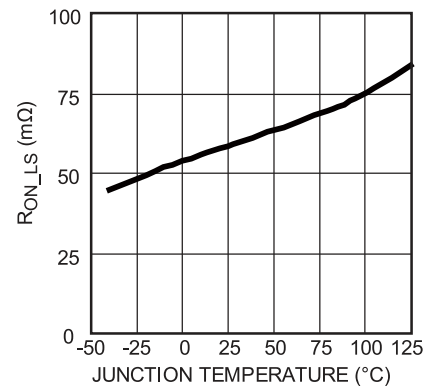
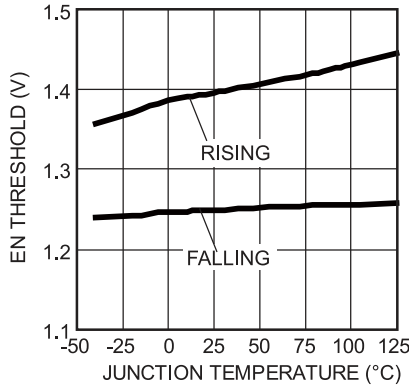
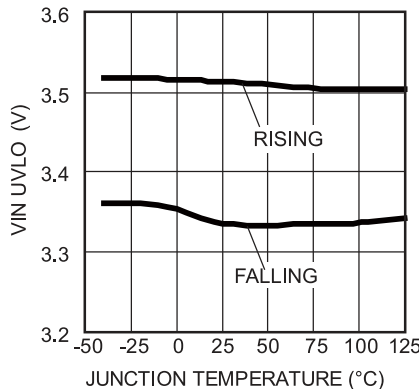
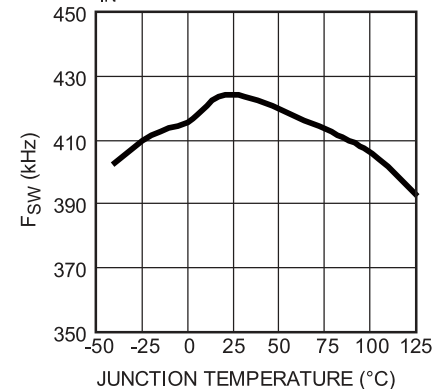
**TYPICAL CHARACTERISTICS**
**Quiescent Current vs. Junction Temperature**  
 $V_{IN}=12V$ 

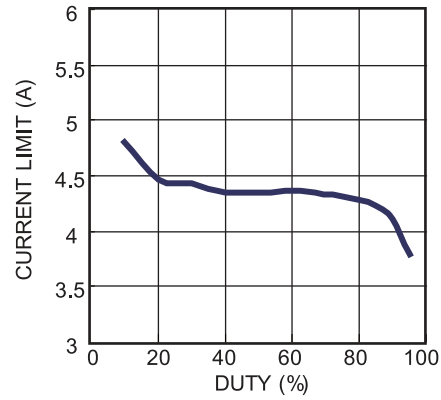
**Shutdown Current vs. Junction Temperature**  
 $V_{IN}=12V$ 

**Current Limit vs. Junction Temperature**  
 $V_{IN}=12V, V_{CC}=5V$   
 Duty Cycle=40%

**Feedback Voltage vs. Junction Temperature**  
 $V_{IN}=12V$ 

 **$R_{ON-HS}$  vs. Junction Temperature**  
 $V_{IN}=12V, BST-SW=5V$ 

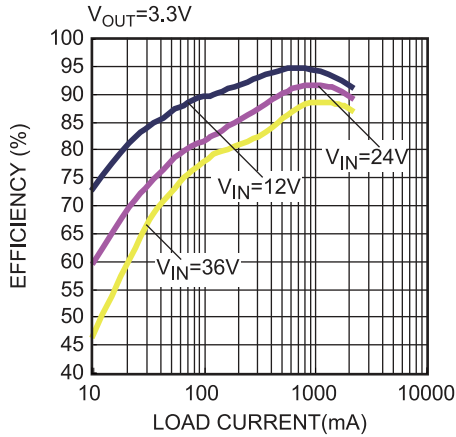
 **$R_{ON-LS}$  vs. Junction Temperature**  
 $V_{IN}=12V, V_{CC}=5V$ 

**EN Threshold vs. Junction Temperature**  
 $V_{IN}=12V$ 

 **$V_{IN}$  UVLO vs. Junction Temperature**

 **$F_{SW}$  vs. Junction Temperature**  
 $V_{IN}=12V$ 

**TYPICAL CHARACTERISTICS** *(continued)***Current Limit vs. Duty**  
 $T_J = +25^\circ\text{C}$ 

**TYPICAL PERFORMANCE CHARACTERISTICS**

$V_{IN} = 12V$ ,  $V_{OUT} = 3.3V$ ,  $L = 10\mu H$ ,  $R_{BST}=20\Omega$ ,  $T_A = +25^\circ C$ , unless otherwise noted.

**Efficiency vs. Load Current**



**Efficiency vs. Load Current**

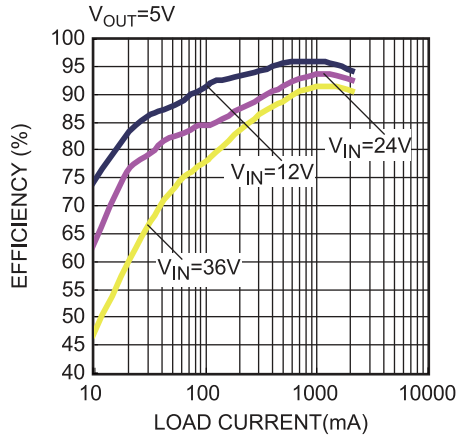

**Thermal Rise**

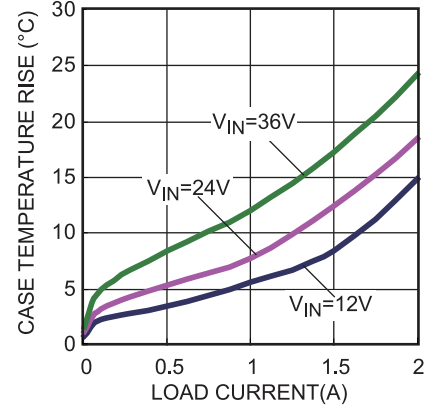

**Load Regulation**

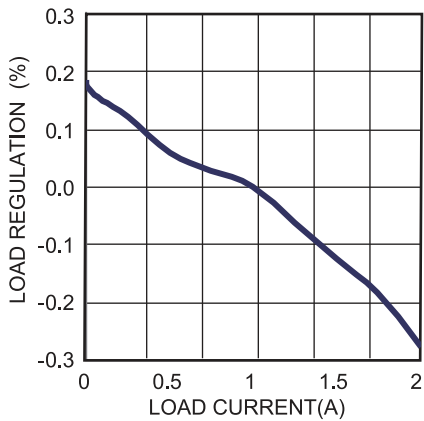

**Line Regulation**

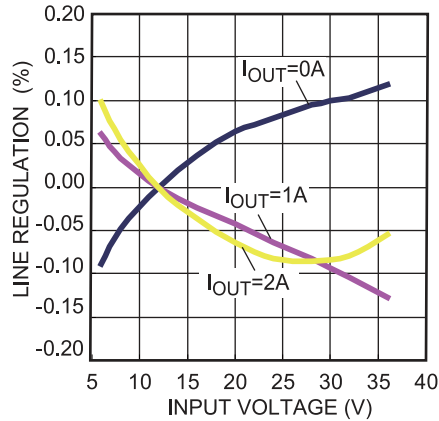



**TYPICAL PERFORMANCE CHARACTERISTICS** *(continued)*

$V_{IN} = 12V$ ,  $V_{OUT} = 3.3V$ ,  $L = 10\mu H$ ,  $R_{BST} = 20\Omega$ ,  $T_A = +25^\circ C$ , unless otherwise noted.

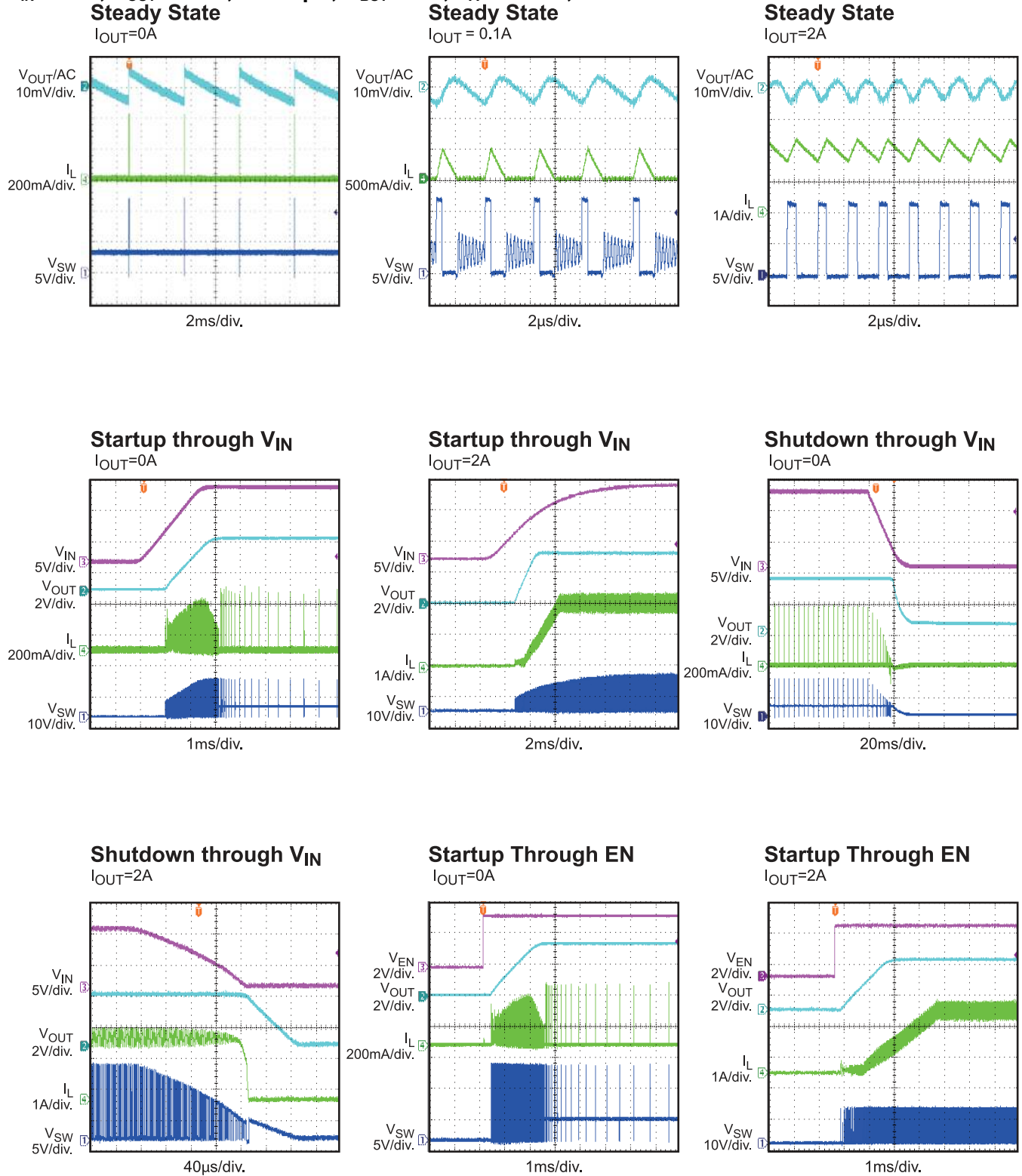

**TYPICAL PERFORMANCE CHARACTERISTICS (continued)**
 $V_{IN} = 12V, V_{OUT} = 3.3V, L = 10\mu H, R_{BST} = 20\Omega, T_A = +25^\circ C$ , unless otherwise noted.

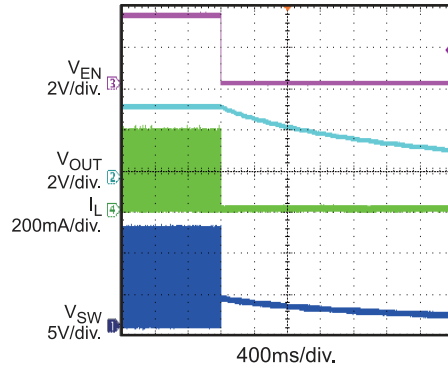
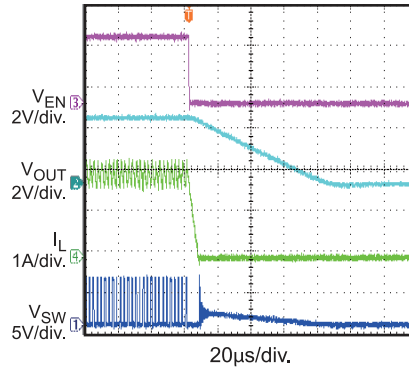
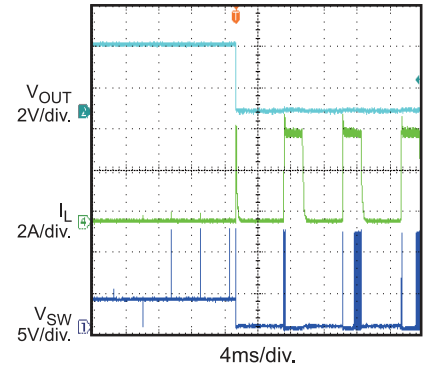
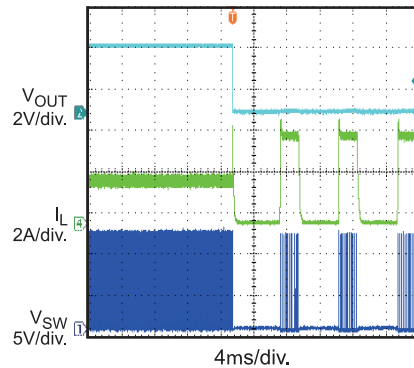
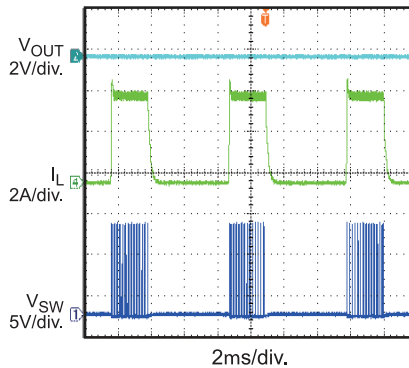
**Shutdown Through EN**
 $I_{OUT} = 0A$ 

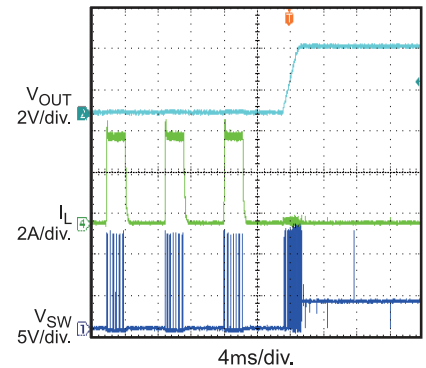
**Shutdown Through EN**
 $I_{OUT} = 2A$ 

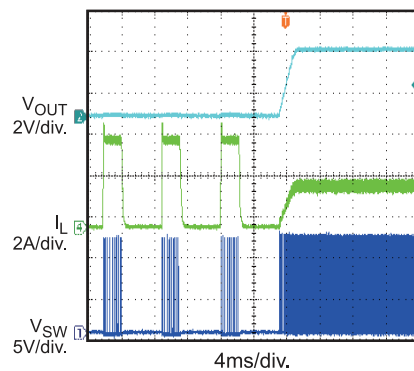
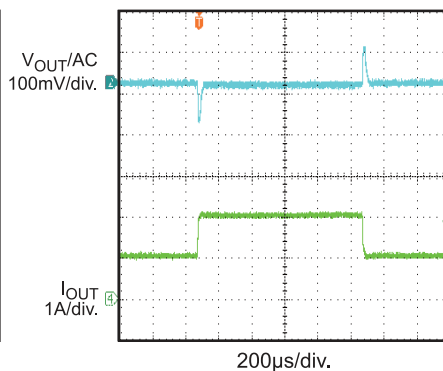
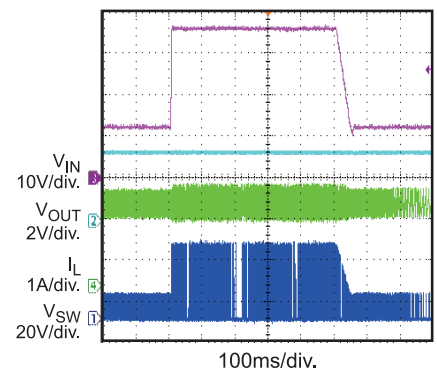
**SCP Entry**
 $I_{OUT} = 0A$  to Short Circuit

**SCP Entry**
 $I_{OUT} = 2A$  to Short Circuit

**SCP Steady State**

**SCP Recovery**

 Short Circuit to  $I_{OUT} = 0A$ 

**SCP Recovery**

 Short Circuit to  $I_{OUT} = 2A$ 

**Load Transient**
 $I_{OUT} = 1A \leftrightarrow 2A, 1.6A/\mu s$ 

**Load Dump**
 $V_{IN} = 12V \leftrightarrow 36V, I_{OUT} = 2A$ 

**TYPICAL PERFORMANCE CHARACTERISTICS** *(continued)*

$V_{IN} = 12V$ ,  $V_{OUT} = 3.3V$ ,  $L = 10\mu H$ ,  $R_{BST}=20\Omega$ ,  $T_A = +25^\circ C$ , unless otherwise noted.

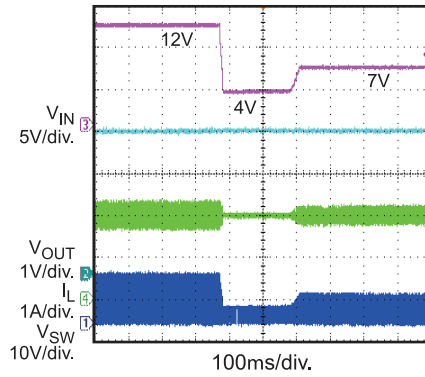
**Cold-Crank**

$V_{OUT}=3.3V$ ,  $I_{OUT}=2A$



**Cold-Crank**

$V_{OUT}=5V$ ,  $I_{OUT}=2A$

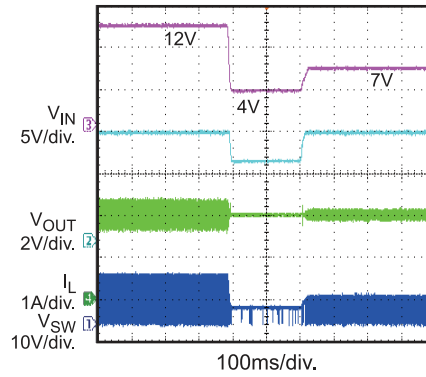

## PIN FUNCTIONS

Package Pin #	Name	Description
1	PG	Power Good. The output of this pin is an open drain and goes high if the output voltage exceeds 90% of the nominal voltage.
2	IN	Supply Voltage. The MP4420H operates from a 4V to 36V input rail. Requires C1 to decouple the input rail. Connect using a wide PCB trace.
3	SW	Switch Output. Connect using a wide PCB trace.
4	GND	System Ground. This pin is the reference ground of the regulated output voltage, and PCB layout requires special care. For best results, connect to GND with copper traces and vias.
5	BST	Bootstrap. Requires a capacitor connected between SW and BST pins to form a floating supply across the high-side switch driver. A 20Ω resistor placed between SW and BST cap is strongly recommended to reduce SW spike voltage.
6	EN/SYNC	Enable/Synchronize. EN high to enable the MP4420H. Apply an external clock to the EN pin to change the switching frequency.
7	VCC	Bias Supply. Decouple with 0.1μF-to-0.22μF capacitor. Select a capacitor that does not exceed 0.22μF
8	FB	Feedback. Connect to the tap of an external resistor divider from the output to GND, to set the output voltage. The frequency fold-back comparator lowers the oscillator frequency when the FB voltage is below 660mV to prevent current limit runaway during a short-circuit fault condition.

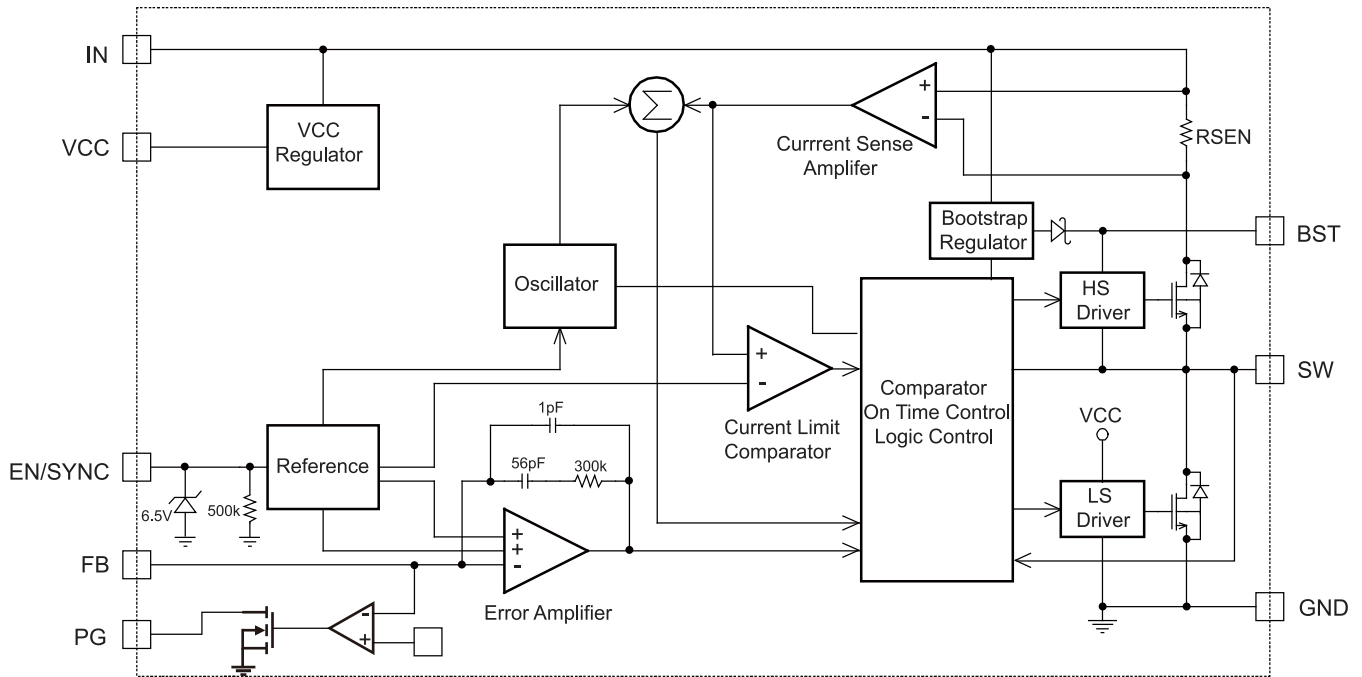
**BLOCK DIAGRAM**

**Figure 1: Functional Block Diagram**

## OPERATION

The MP4420H is a high-frequency, synchronous, rectified, step-down, switch-mode converter with built-in power MOSFETs. It offers a very compact solution to achieve 2A continuous output current with excellent load and line regulation over a wide input supply range.

The MP4420H operates in a fixed-frequency, peak-current-control mode to regulate the output voltage. An internal clock initiates a PWM cycle. The integrated high-side power MOSFET turns on and remains on until its current reaches the value set by the COMP voltage. When the power switch is off, it remains off until the next clock cycle starts. If the current in the power MOSFET does not reach the current value set by COMP within 95% of one PWM period, the power MOSFET will be forced to turn off.

### Internal Regulator

The 5V internal regulator powers most of the internal circuitries. This regulator takes the  $V_{IN}$  input and operates in the full  $V_{IN}$  range: When  $V_{IN}$  exceeds 5.0V, the output of the regulator is in full regulation; when  $V_{IN}$  falls below 5.0V, the output of the regulator decreases following the  $V_{IN}$ . A 0.1 $\mu$ F decoupling ceramic capacitor is needed at the pin.

### Error Amplifier

The error amplifier compares the FB pin voltage against the internal 0.8V reference (REF) and outputs a COMP voltage—this COMP voltage controls the power MOSFET current. The optimized internal compensation network minimizes the external component count and simplifies the control loop design.

### Enable/SYNC Control

EN/SYNC is a digital control pin that turns the regulator on and off. Drive EN high to turn on the regulator, drive it low to turn it off. An internal 500k $\Omega$  resistor from EN/SYNC to GND allows EN/SYNC to be floated to shut down the chip.

The EN pin is clamped internally using a 6.5V series Zener diode, as shown in Figure 2. Connect the EN input pin through a pullup resistor to any voltage connected to the  $V_{IN}$  pin—the pullup resistor limits the EN input current to less than 150 $\mu$ A.

For example, with 12V connected to  $V_{IN}$ ,  $R_{PULLUP} \geq (12V - 6.5V) \div 150\mu A = 36.7k\Omega$ .

Connecting the EN pin directly to a voltage source without any pullup resistor requires limiting voltage amplitude to  $\leq 6V$  to prevent damage to the Zener diode.

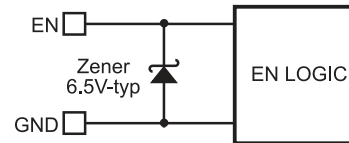

**Figure 2: 6.5V-type Zener Diode**

Connect an external clock with a range of 200kHz to 2.2MHz 2ms after output voltage is set to synchronize the internal clock rising edge to the external clock rising edge. The pulse width of external clock signal should be less than 1.7 $\mu$ s.

### Under-Voltage Lockout

Under-voltage lockout (UVLO) protects the chip from operating at an insufficient supply voltage. The MP4420H UVLO comparator monitors the output voltage of the internal regulator, VCC. The UVLO rising threshold is about 3.5V while its falling threshold is 3.3V.

### Internal Soft-Start

The soft-start prevents the converter output voltage from overshooting during startup. When the chip starts, the internal circuitry generates a soft-start voltage (SS) that ramps up from 0V to 1.2V. When SS is lower than REF, SS overrides REF so the error amplifier uses SS as the reference. When SS exceeds REF, the error amplifier uses REF as the reference. The SS time is internally set to 1.5ms.

### Over-Current Protection and Hiccup

The MP4420H has cycle-by-cycle over current limit when the inductor current peak value exceeds the set current limit threshold. If the output voltage starts to drop until FB is below the Under-Voltage (UV) threshold—typically 84% below the reference—the MP4420H enters hiccup mode to periodically restart the part. This protection

mode is especially useful when the output is dead-short-circuited to ground. The average short-circuit current is greatly reduced to alleviate the thermal issue and to protect the regulator. The MP4420H exits the hiccup mode once the over-current condition is removed.

### Thermal Shutdown

Thermal shutdown prevents the chip from operating at exceedingly high temperatures. When the silicon die temperature exceeds 170°C, it shuts down the whole chip. When the temperature drops below its lower threshold (typically 140°C) the chip is enabled again.

### Floating Driver and Bootstrap Charging

An external bootstrap capacitor powers the floating-power-MOSFET driver. A dedicated internal regulator (see figure 3) charges and regulates the bootstrap capacitor voltage to ~5V. When the voltage between the BST and SW nodes drops below regulation, a PMOS pass transistor connected from  $V_{IN}$  to BST turns on. The charging current path is from  $V_{IN}$ , BST and then to SW. The external circuit should provide enough voltage headroom to facilitate charging. As long as  $V_{IN}$  is significantly higher than SW, the bootstrap capacitor remains charged. When the HS-FET is ON,  $V_{IN} \approx V_{SW}$  so the bootstrap capacitor cannot charge. When the LS-FET is ON,  $V_{IN} - V_{SW}$  reaches its maximum for fast charging. When there is no inductor current,  $V_{SW} = V_{OUT}$  so the difference between  $V_{IN}$  and  $V_{OUT}$  can charge the bootstrap capacitor. The floating driver has its own UVLO protection, with a rising threshold of 2.2V and hysteresis of 150mV. A 20Ω resistor placed between SW and BST cap is strongly recommended to reduce SW spike voltage.

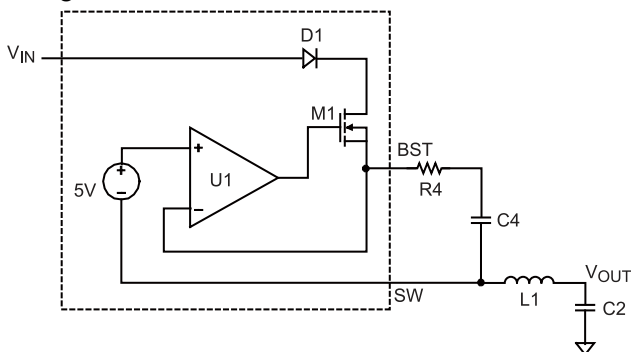

Figure 3: Internal Bootstrap Charging Circuit

### Startup and Shutdown

If both  $V_{IN}$  and EN exceed their appropriate thresholds, the chip starts: The reference block starts first, generating stable reference voltage and currents, and then the internal regulator is enabled. The regulator provides stable supply for the remaining circuitries.

Three events can shut down the chip: EN low,  $V_{IN}$  low, and thermal shutdown. In the shutdown procedure, the signaling path is first blocked to avoid any fault triggering. The COMP voltage and the internal supply rail are then pulled down. The floating driver is not subject to this shutdown command.

### Power Good

The MP4420H has power good (PG) output. The PG pin is the open drain of a MOSFET. It should be connected to VCC or some other voltage source through a resistor (e.g. 100kΩ). In the presence of an input voltage, the MOSFET turns on so that the PG pin is pulled to low before SS is ready. After  $V_{FB}$  reaches 90%×REF, the PG pin is pulled high after a delay, typically 90μs. When  $V_{FB}$  drops to 84%×REF, the PG pin is pulled low. Also, PG is pulled low if thermal shutdown or EN is pulled low.

## APPLICATION INFORMATION

### Setting the Output Voltage

The external resistor divider sets the output voltage (see Typical Application on page 1). The feedback resistor R1 also sets the feedback loop bandwidth with the internal compensation capacitor. Choose R1 around 40kΩ. R2 is then given by:

$$R2 = \frac{R1}{\frac{V_{OUT}}{0.792V} - 1}$$

The T-type network—as shown in Figure 4—is highly recommended when  $V_{OUT}$  is low.

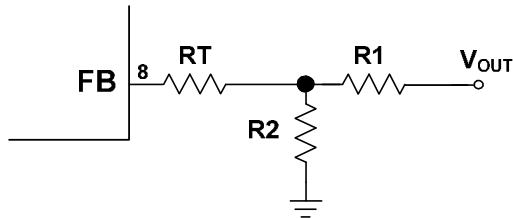

**Figure 4: T-Type Network**

$R_T+R_1$  is used to set the loop bandwidth. Basically, higher  $R_T+R_1$ , lower bandwidth. To ensure the loop stability, it is strongly recommended to limit the bandwidth lower than 40kHz based on the 410kHz default fsw. Table 1 lists the recommended T-type resistors value for common output voltages.

**Table 1: Resistor Selection for Common Output Voltages**

$V_{OUT}$ (V)	R1 (kΩ)	R2 (kΩ)	RT (kΩ)
3.3	41.2 (1%)	13 (1%)	51 (1%)
5	41.2 (1%)	7.68 (1%)	51 (1%)

### Selecting the Inductor

Use a 1μH-to-10μH inductor with a DC current rating of at least 25% percent higher than the maximum load current for most applications. For highest efficiency, an inductor with small DC resistance is recommended. For most designs, the inductance value can be derived from the following equation.

$$L_1 = \frac{V_{OUT} \times (V_{IN} - V_{OUT})}{V_{IN} \times \Delta I_L \times f_{OSC}}$$

Where  $\Delta I_L$  is the inductor ripple current.

Choose the inductor ripple current to be approximately 30% of the maximum load current. The maximum inductor peak current is:

$$I_{L(MAX)} = I_{LOAD} + \frac{\Delta I_L}{2}$$

Use a larger inductor for improved efficiency under light-load conditions—below 100mA.

### VIN UVLO Setting

MP4420H has internal fix under voltage lock out (UVLO) threshold: rising threshold is 3.5V while falling threshold is about 3.3V. For the application needs higher UVLO point, external resistor divider between EN and IN as shown in figure 4 can be used to get higher equivalent UVLO threshold.

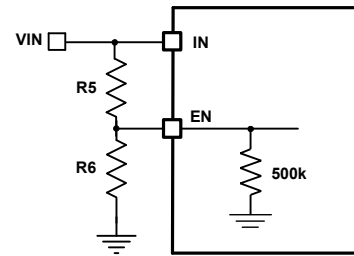

**Figure 5: Adjustable UVLO using EN divider**

The UVLO threshold can be computed from below two equations:

$$INUV_{RISING} = \left(1 + \frac{R5}{500k//R6}\right) \times V_{EN\_RISING}$$

$$INUV_{FALLING} = \left(1 + \frac{R5}{500k//R6}\right) \times V_{EN\_FALLING}$$

Where  $V_{EN\_RISING}=1.4V$ ,  $V_{EN\_FALLING}=1.25V$ .

When choose R5, make sure it is big enough to limit the current flows into EN pin lower than 150uA.



### Selecting the Input Capacitor

The input current to the step-down converter is discontinuous, therefore requires a capacitor is to supply the AC current to the step-down converter while maintaining the DC input voltage. Use low ESR capacitors for the best performance. Use ceramic capacitors with X5R or X7R dielectrics for best results because of their low ESR and small temperature coefficients.

For most application, a 22µF ceramic capacitor is sufficient to maintain the DC input voltage. And it is strongly recommended to use another lower value capacitor (e.g. 0.1µF) with small package size (0603) to absorb high frequency switching noise. Make sure place the small size capacitor as close to IN and GND pins as possible (see PCB LAYOUT section).

Since C1 absorbs the input switching current, it requires an adequate ripple current rating. The RMS current in the input capacitor can be estimated by:

$$I_{C1} = I_{LOAD} \times \sqrt{\frac{V_{OUT}}{V_{IN}} \times \left(1 - \frac{V_{OUT}}{V_{IN}}\right)}$$

The worse case condition occurs at  $V_{IN} = 2V_{OUT}$ , where:

$$I_{C1} = \frac{I_{LOAD}}{2}$$

For simplification, choose an input capacitor with an RMS current rating greater than half of the maximum load current.

The input capacitor can be electrolytic, tantalum or ceramic. When using electrolytic or tantalum capacitors, add a small, high quality ceramic capacitor (e.g. 1µF) placed as close to the IC as possible. When using ceramic capacitors, make sure that they have enough capacitance to provide sufficient charge to prevent excessive

voltage ripple at input. The input voltage ripple caused by capacitance can be estimated by:

$$\Delta V_{IN} = \frac{I_{LOAD}}{f_s \times C1} \times \frac{V_{OUT}}{V_{IN}} \times \left(1 - \frac{V_{OUT}}{V_{IN}}\right)$$

### Selecting the Output Capacitor

The output capacitor (C2) maintains the DC output voltage. Use ceramic, tantalum, or low-ESR electrolytic capacitors. For best results, use low ESR capacitors to keep the output voltage ripple low. The output voltage ripple can be estimated by:

$$\Delta V_{OUT} = \frac{V_{OUT}}{f_s \times L_1} \times \left(1 - \frac{V_{OUT}}{V_{IN}}\right) \times \left(R_{ESR} + \frac{1}{8 \times f_s \times C2}\right)$$

Where  $L_1$  is the inductor value and  $R_{ESR}$  is the equivalent series resistance (ESR) value of the output capacitor.

For ceramic capacitors, the capacitance dominates the impedance at the switching frequency, and the capacitance causes the majority of the output voltage ripple. For simplification, the output voltage ripple can be estimated by:

$$\Delta V_{OUT} = \frac{V_{OUT}}{8 \times f_s^2 \times L_1 \times C2} \times \left(1 - \frac{V_{OUT}}{V_{IN}}\right)$$

For tantalum or electrolytic capacitors, the ESR dominates the impedance at the switching frequency. For simplification, the output ripple can be approximated to:

$$\Delta V_{OUT} = \frac{V_{OUT}}{f_s \times L_1} \times \left(1 - \frac{V_{OUT}}{V_{IN}}\right) \times R_{ESR}$$

The characteristics of the output capacitor also affect the stability of the regulation system. The MP4420H can be optimized for a wide range of capacitance and ESR values.

### BST Resistor and External BST Diode

A 20ohm resistor in series with BST capacitor is recommended to reduce the SW spike voltage. Higher resistance is better for SW spike reduction, but will compromise the efficiency on the other hand.

An external BST diode can enhance the efficiency of the regulator when the duty cycle is high (>65%). A power supply between 2.5V and 5V can be used to power the external bootstrap diode and VCC or VOUT is the good choice of this power supply in the circuit as shown in Figure 6.

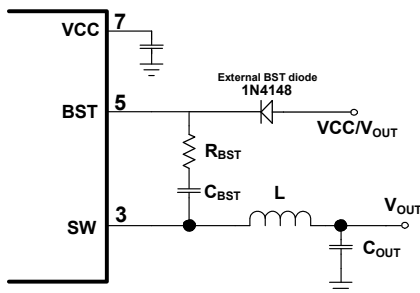

**Figure 6: Optional External Bootstrap Diode to Enhance Efficiency**

The recommended external BST diode is 1N4148, and the BST capacitor value is 0.1µF to 1µF.

### PCB Layout

PCB layout, especially the input capacitor and VCC capacitor placement, is very important to achieve stable operation. For the best results, follow these guidelines:

- 1) Place the ceramics input capacitor as close to IN and GND pins as possible, especially the small package size (0603) input bypass capacitor. Keep the connection of input capacitor and IN pin as short and wide as possible.
- 2) Place the VCC capacitor to VCC pin and GND pin as close as possible. Make the trace length of VCC pin-VCC capacitor anode-VCC capacitor cathode-chip GND pin as short as possible.

- 3) Use large ground plane directly connect to GND pin. Add vias near the GND pin if bottom layer is ground plane.
- 4) Route SW, BST away from sensitive analog areas such as FB.
- 5) Place the T-type feedback resistor close to chip to ensure the trace which connects to FB pin as the short as possible.

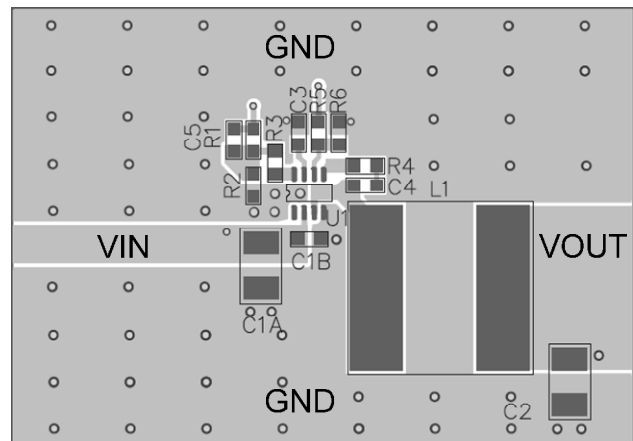

**Top Layer**

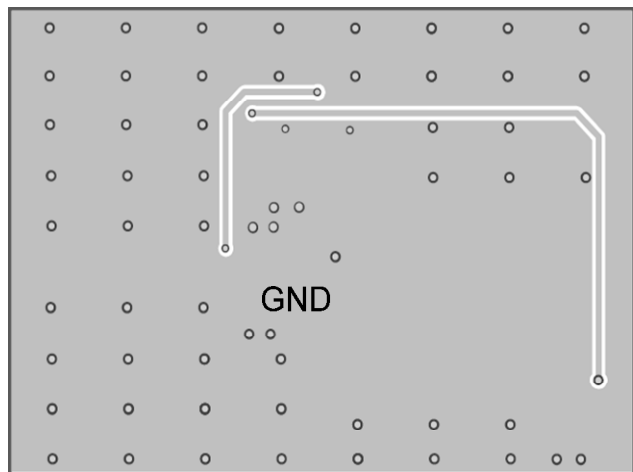

**Bottom Layer**

**Figure 7: Recommended PCB Layout**

## TYPICAL APPLICATION CIRCUITS

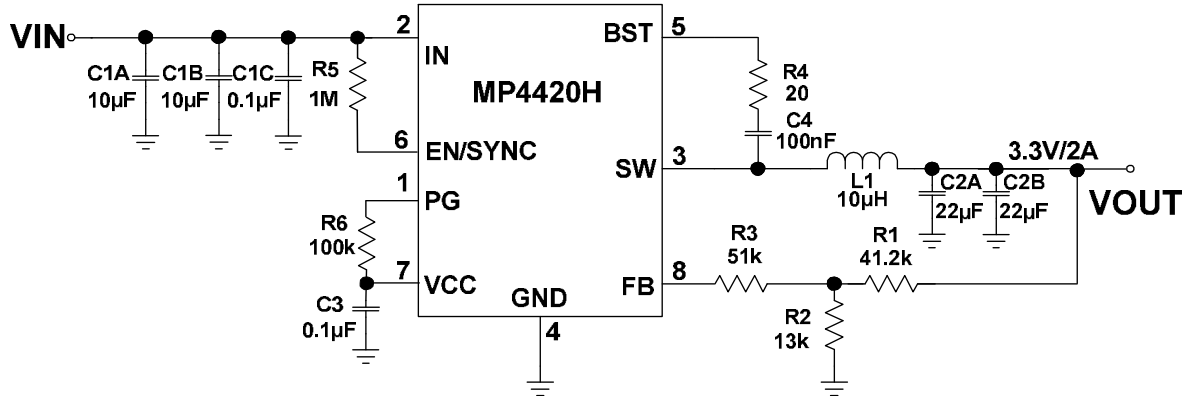
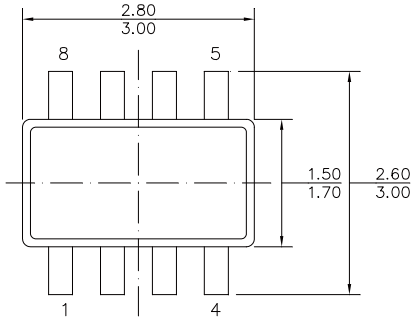

Figure 8: 3.3V Output Typical Application Circuit

## PACKAGE INFORMATION

### TSOT23-8



TOP VIEW

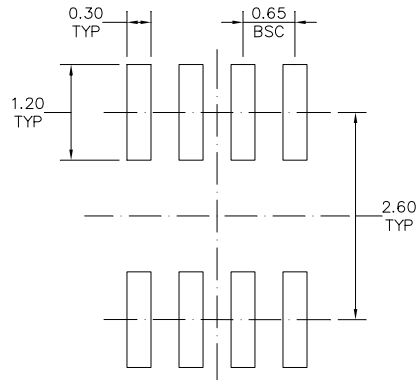

RECOMMENDED LAND PATTERN

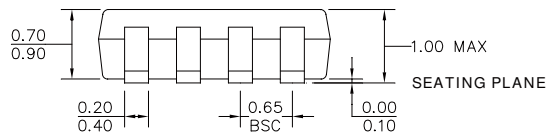

FRONT VIEW

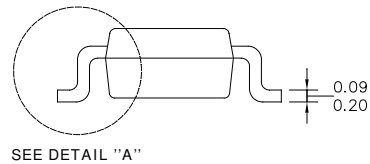

SIDE VIEW

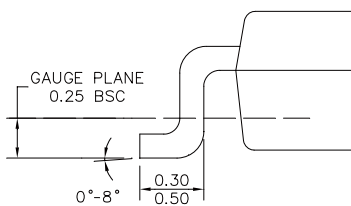

DETAIL "A"

### NOTE:

- 1) ALL DIMENSIONS ARE IN MILLIMETERS.
- 2) PACKAGE LENGTH DOES NOT INCLUDE MOLD FLASH, PROTRUSION OR GATE BURR.
- 3) PACKAGE WIDTH DOES NOT INCLUDE INTERLEAD FLASH OR PROTRUSION.
- 4) LEAD COPLANARITY (BOTTOM OF LEADS AFTER FORMING) SHALL BE 0.10 MILLIMETERS MAX.
- 5) JEDEC REFERENCE IS MO-193, VARIATION BA.
- 6) DRAWING IS NOT TO SCALE.

**NOTICE:** The information in this document is subject to change without notice. Users should warrant and guarantee that third party Intellectual Property rights are not infringed upon when integrating MPS products into any application. MPS will not assume any legal responsibility for any said applications.