

LUXslim Swerve 18V

Architectural Axial LED Tape

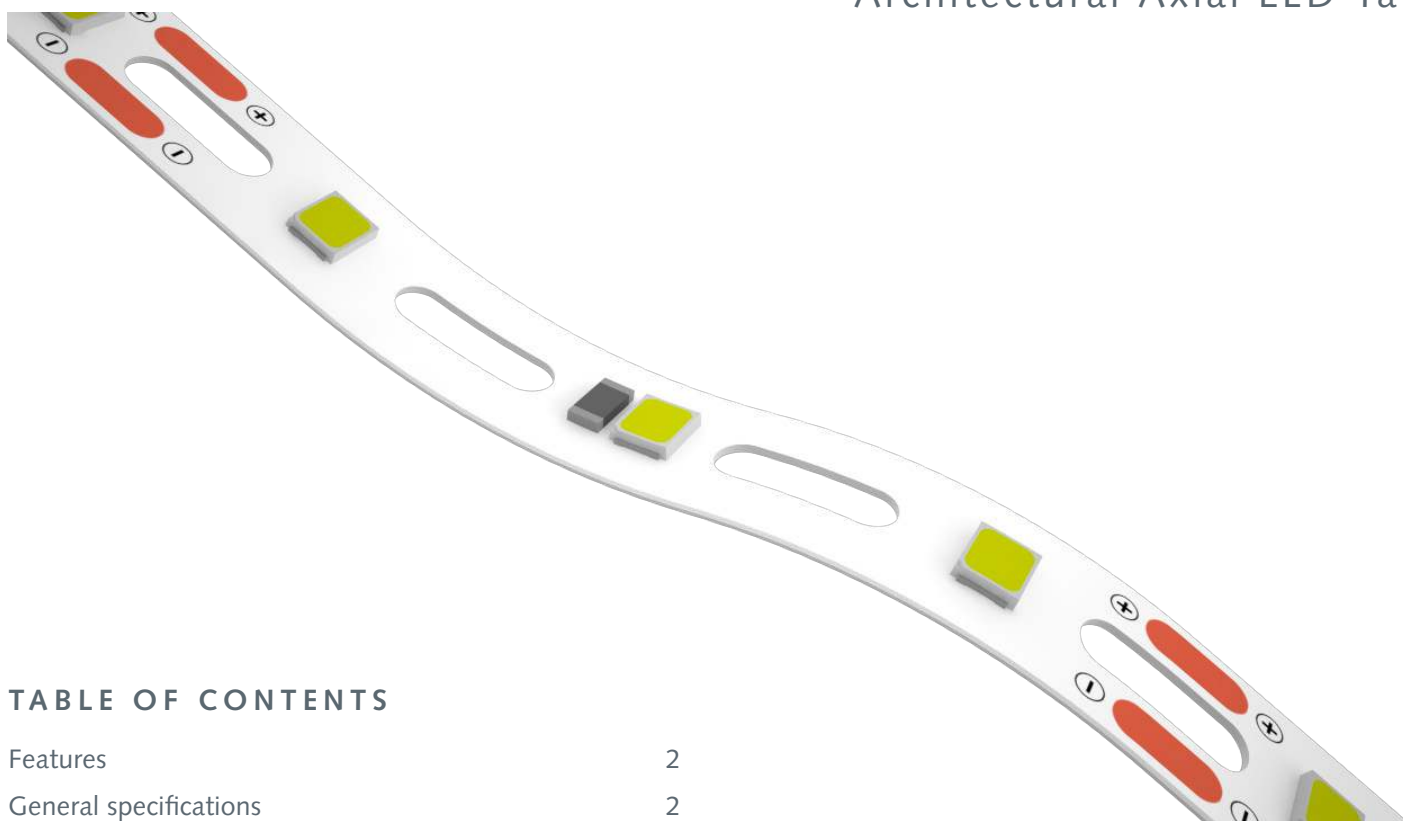

TABLE OF CONTENTS

Features	2
General specifications	2
Optical specifications	3
Electrical characteristics	5
Absolute maximum ratings	6
Derating	6
Mechanical characteristics	8
Accessories and design resources	9
Color binning information	10
Ordering information	11
About LUXTECH	12

Project ||

Type ||

Quantity ||

LUXslim Swerve 18V

Architectural Axial LED Tape

LUXTECH LUXslim Swerve not only flexes but also bends axially. Luminaire designers are no longer limited to illumination in a single plane. This high-performance, specification grade LED tape is cuttable in convenient 1.97" increments and accepts constant current input.

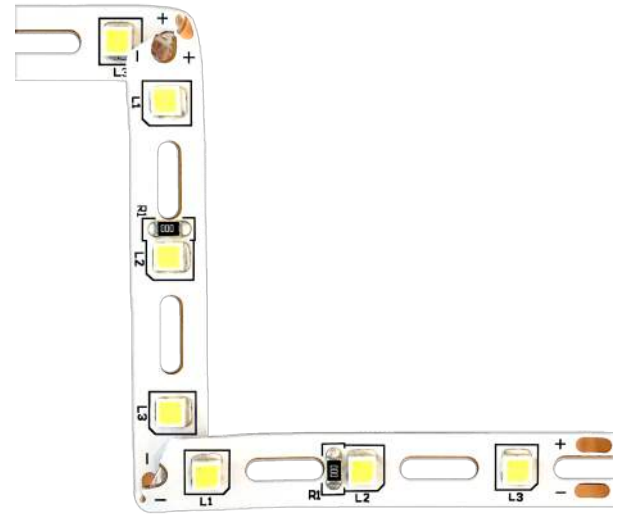

FEATURES

- » 5-Year Warranty
- » Flexible LED strip
- » Polyimide substrate
- » Cuttable every 1.97"
- » 0.31" (8mm) Width
- » Constant Current Input
- » White LEDs LM-80 Tested by Nichia
- » 3-Step MacAdam Binning
- » 90 CRI Standard
- » Axially bendable over 90 degrees, radially bendable up to 90 degrees
- » Specification-Grade 3M 200MP Adhesive Backing
- » Tape application on bare aluminum recommended

GENERAL SPECIFICATIONS

- » Forward Voltage: 18V
- » Max Output: 2280 lm/ft (3000K 90 CRI White LEDs)
- » LED Pitch: 0.66"
- » Color Rendering Index: 90+
- » L70 > 36,000 hours at 105°C
- » 1+1 oz Copper
- » R9: 50+
- » Max Recommended Run Length: 7'
- » Beam Angle: 120°
- » 125 lm/W Nominal Efficacy
- » 16.4' reels

Project ||

Type ||

Quantity ||

OPTICAL SPECIFICATIONS

SPECTRAL POWER DISTRIBUTION, WHITE

2700K 3-STEP

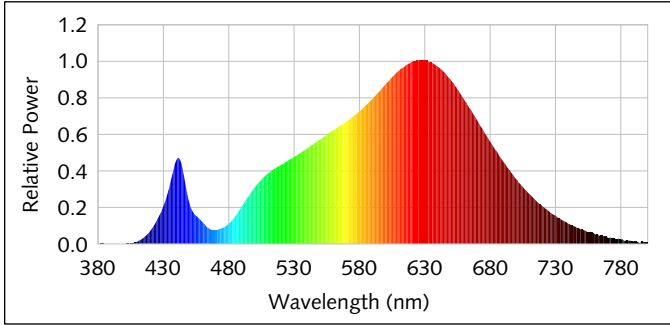

4000K 3-STEP

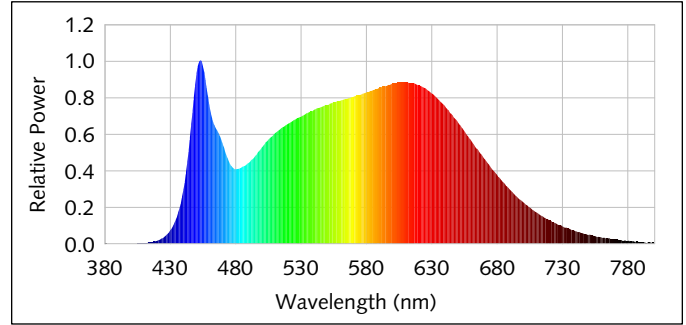

3000K 3-STEP

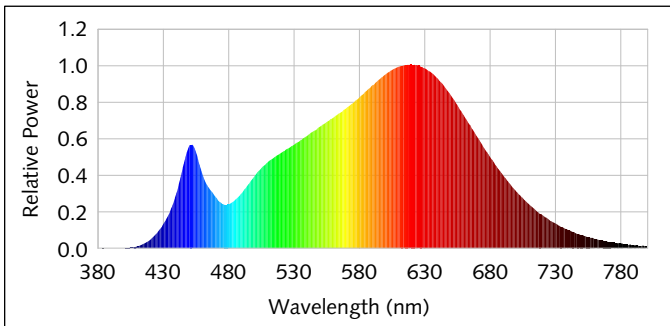

5000K 3-STEP

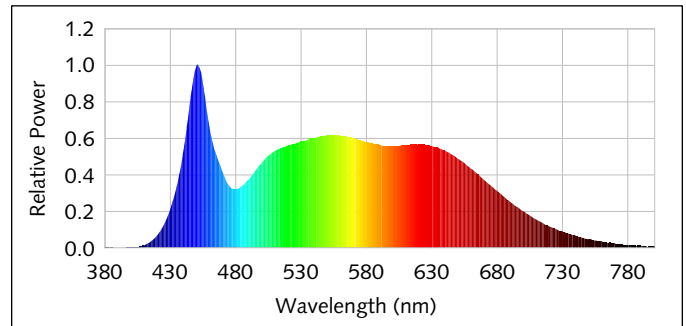

3500K 3-STEP

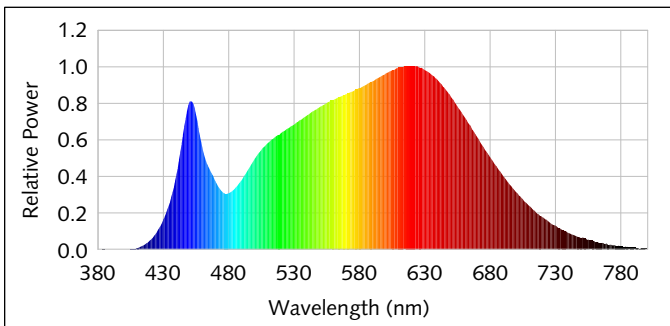

6500K 3-STEP

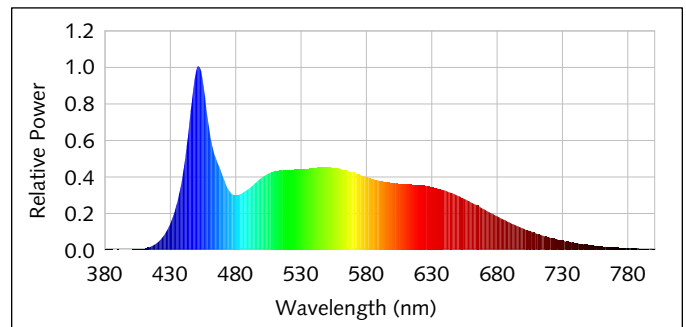

Project ||

Type ||

Quantity ||

OPTICAL SPECIFICATIONS

BEAM ANGLE

WHITE

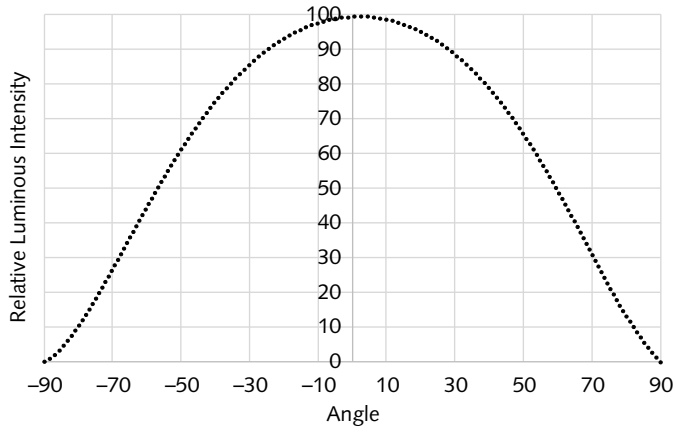

Project ||

Type ||

Quantity ||

ELECTRICAL CHARACTERISTICS

Assuming 35K 90 CRI, 25°C

1 FOOT					
Current (mA)	100	150	390	900	1080
Voltage (V)	16	16.2	17.1	18.9	19.5
Flux (lm/ft)	280	430	870	1740	2280

4 FEET					
Current (mA)	400	600	1560	3600	4320
Voltage (V)	16	16.2	17.1	18.9	19.5
Flux (lm)	1120	1720	3480	6960	9120

6 FEET					
Current (mA)	600	900	2340	5400	6480
Voltage (V)	16	16.2	17.1	18.9	19.5
Flux (lm)	1680	2580	5220	10440	13680

INSTRUCTIONS

Determine the drive current for your application:

1. Start with the target length and lumens/ft to determine the nominal drive current.
2. Multiply by the de-rating factor for the target color temperature.
3. Multiply by the re-rating factor for the expected case temperature.
4. Pick a driver that is compatible with the calculated drive current and compliance voltage range.

EFFICACY VS. CURRENT

WHITE

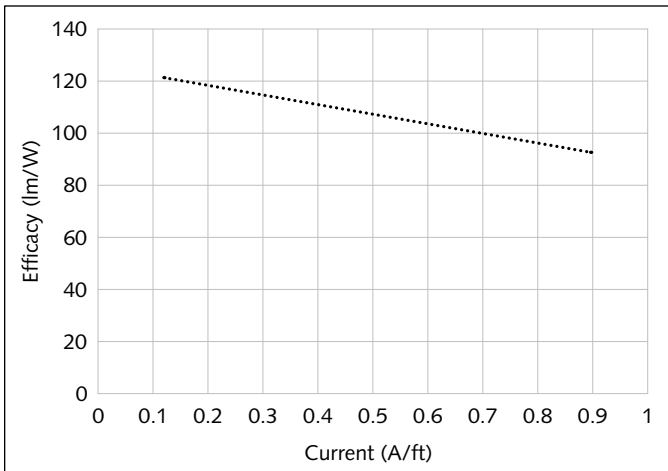

Project ||

Type ||

Quantity ||

ABSOLUTE MAXIMUM RATINGS

30K, 90CRI

Current (mA/ft)	1080
Voltage (V)	20
Flux (lm/ft)	2280
Temperature (°C)	85

COMPONENTS

Max Recommended Run Length (ft)	8
---------------------------------	---

Project ||

Type ||

Quantity ||

DERATING

COLOR TEMPERATURE	LIGHT OUTPUT
2700K	97%
3000K	100%
3500K	106%
4000K	111%
5000K	111%
6500K	107%

VOLTAGE VS. TEMPERATURE

WHITE

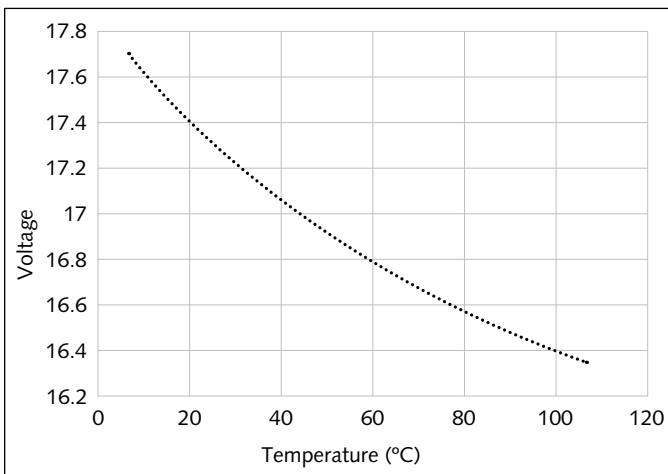

FLUX VS. TEMPERATURE

WHITE

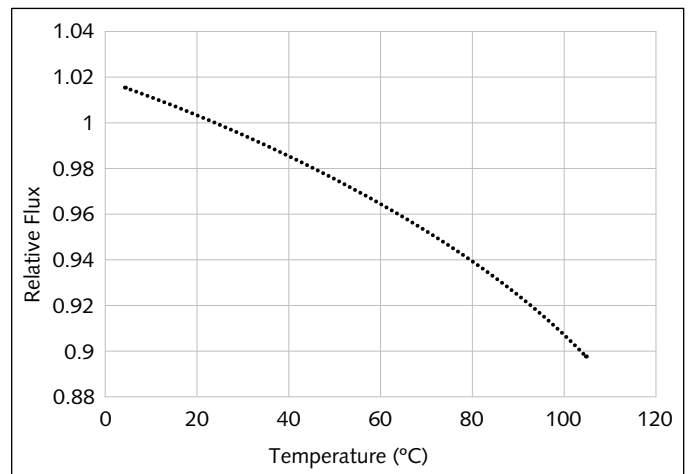

Project ||

Type ||

Quantity ||

MECHANICAL CHARACTERISTICS

TECHNICAL DRAWING

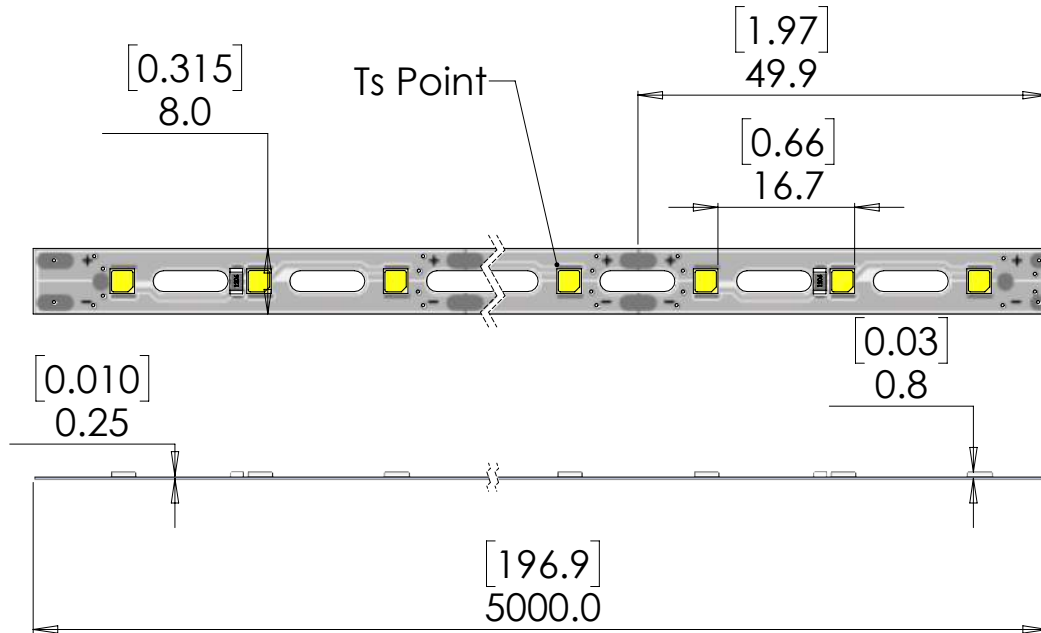

PRODUCT DIMENSIONS

DIMENSION	VALUE (IN)
Length	197.0
Width	0.31
Thickness	0.12
Cutable Length	1.97
LED Pitch	0.66

Project ||

Type ||

Quantity ||

ACCESSORIES AND DESIGN RESOURCES

CAD files available at LUXTECH.com

Project ||

Type ||

Quantity ||

COLOR BINNING INFORMATION

2700K 3-STEP

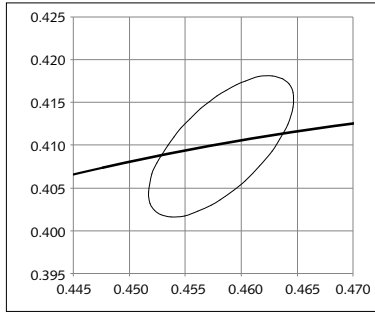

4000K 3-STEP

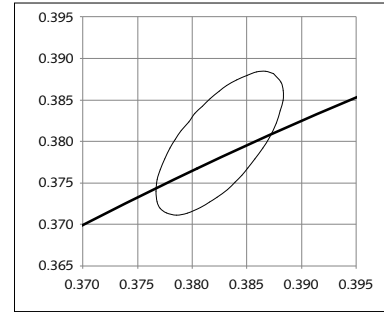

3000K 3-STEP

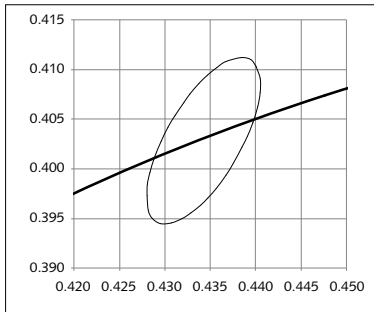

5000K 3-STEP

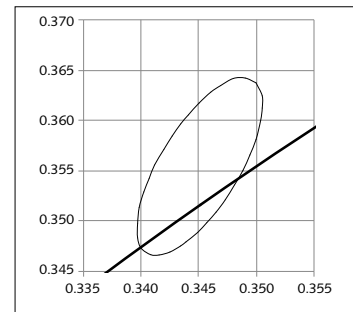

3500K 3-STEP

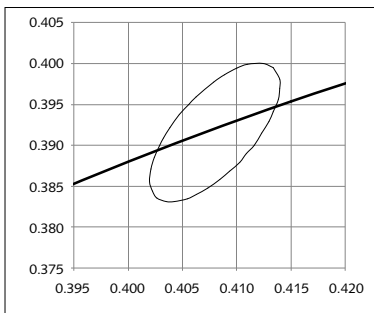

6500K 3-STEP

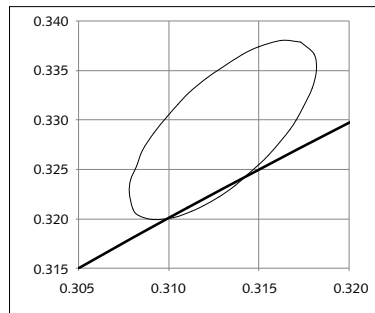

Project ||

Type ||

Quantity ||

ORDERING INFORMATION

PRODUCT CODES

LUXSLIM REELS ARE 16.4' LONG

PRODUCT	COLOR TEMP	CRI	REEL LENGTH (METERS)
LUXSLIM-SW-20-18V	27K	80	5
	30K	90	
	35K		
	40K		
	50K		
	65K		

*Normally stocked

EXAMPLE: LUXSLIM-SW-20-18V-XXK-YY-5

FORMERLY FX-SW-20-18V-XXK-YY-5

SUGGESTED CONNECTORS

PRODUCT	MANUFACTURER	DESCRIPTION
OL11-SL8XB-2W	Onlumi	8mm Narrow Wire-to-Board Connector with Multicolored Wire
OL11-SL8XB-2	Onlumi	8mm Narrow Wire-to-Board Connector, No Wire
OL11-SL8BB-2W	Onlumi	8mm Narrow Board-to-Board Connector with Multicolored Wire
OL11-SL8BXB-2	Onlumi	8mm Narrow Board-to-Board Connector, No Wire
OL11-SEN8XB-2W	Onlumi	8mm Clear Hippo Wire-to-Board Connector with Multicolored Wire
OL11-SEN8XB-2	Onlumi	8mm Clear Hippo Wire-to-Board Connector, No Wire
OL11-SEN8BB-2W	Onlumi	8mm Clear Hippo Board-to-Board Connector with Multicolored Wire
OL11-SEN8BB-2	Onlumi	8mm Clear Hippo Board-to-Board Connector, No Wire



Architectural-Grade LED Modules

ABOUT LUXTECH

LUXTECH is an LED component design and manufacturing company specializing in high quality LED modules and architectural grade lighting solutions. LUXTECH is a catalyst for health and well-being through human centric lighting systems. Our inventive custom engineering for natural lighting is advancing emotional wellness and productivity with the potential for global social impact. LUXTECH is located in Philadelphia's Old City neighborhood.

325 Chestnut St. Suite 1212,
Philadelphia, PA 19106

sales@luxtech.com
luxtech.com

215-494-3333