

GlobTek, Inc. www.globtek.com 186 Veterans Drive, Northvale, NJ 07647 Tel. (201) 784-1000 Fax (201) 784-0111	Drawing Title: NEMA 5-15P (TYPE B) 2 CONDUCTOR + GROUND PLUG to IEC60320 C13 2 CONDUCTORS + GROUND, GT Cable #106: 18 / 3 Conductors, 7.8mm OD, SJT, 60 Degree, 300V, BLK/WHT/GRN, Approvals: UL, CSA or cUL,2440±50mm, GlobTek Black	
	Model No. Power Cord	
	Part No./Ordering No. 3021068F701SW(R)	Rev A

CUSTOMIZED LENGTHS, COLORS, CABLE TYPES, TERMINATIONS/PLUGS/RECEPTACLES AVAILABLE UPON REQUEST. ADDITIONAL PLUG OPTIONS ARE AVAILABLE AT <https://www.globtek.com/connectors/> STANDARD PLUGS AND CONNECTORS CAN BE SEEN ONLINE AT <https://www.globtek.com/connectors/> ACTUAL CONNECTORS, OVERMOLDS, FERRITES MAY VARY SLIGHTLY FROM THE PICTURE BELOW DIMENSIONS ARE IN MM UNLESS SPECIFIED OTHERWISE

REVISION HISTORY

REV	DESCRIPTION	SUB	DATE	APPROVED
A	Initial release	DR	04/06/2021	DAVID

In Addition to GlobTek Inc.'s renewed ISO9001:2008 - Quality Management System Certification, GlobTek Inc. is now certified to:

ISO13485:2003 - Medical Devices Quality Management System Certification
ISO14001:2004 - Environmental Management System Certification

ISO Certificates are available online at <https://www.globtek.com/iso-certificates/>
Prop 65 Statement: <https://en.globtek.com/prop-65-statement.pdf>

Customer Approval of Specification:

Please approve, sign and send back to GlobTek so we can complete order processing.

A delay in receipt of this form will delay delivery schedule.

Company Name:

Customer P/N:

Quote Number:

Date:

Authorized Representative Name:

Authorized Representative Signature:

RELEASED

By pudxc at 8:54 am, Apr 21, 2021

The acceptance of this specification and use of the product described in this document indicates the acceptance and binding of the customer to Globtek terms and conditions, which supersede all other agreements, terms, and conditions (<https://en.globtek.com/terms-and-conditions/>).

The purchaser of this product (Customer) agrees that it is their sole responsibility to determine suitability/fitness of the product described in this specification for their application and to take precautions for protection against any hazards attendant to the handling and use of the product.

PROPRIETARY INFORMATION

PROPRIETARY OF GLOBTEK, INC. ANY REPRODUCTION, DISCLOSURE OR USE OF THIS DRAWING, IN WHOLE OR IN PART, IS HEREBY PROHIBITED EXCEPT AS SPECIFIED IN WRITING BY GLOBTEK, INC. © GlobTek, Inc.

2021 - 2021

specC /04/21/2021 10:23:25 AM CLONED FROM 3021068F701(R)

GlobTek, Inc. www.globtek.com 186 Veterans Drive, Northvale, NJ 07647 Tel. (201) 784-1000 Fax (201) 784-0111	Drawing Title: NEMA 5-15P (TYPE B) 2 CONDUCTOR + GROUND PLUG to IEC60320 C13 2 CONDUCTORS + GROUND, GT Cable #106: 18 / 3 Conductors, 7.8mm OD, SJT, 60 Degree, 300V, BLK/WHT/GRN, Approvals: UL, CSA or cUL,2440±50mm, GlobTek Black	
	Model No. Power Cord	
Part No./Ordering No. 3021068F701SW(R)		Rev A

CUSTOMIZED LENGTHS, COLORS, CABLE TYPES, TERMINATIONS/PLUGS/RECEPTACLES AVAILABLE UPON REQUEST. ADDITIONAL PLUG OPTIONS ARE AVAILABLE AT <https://www.globtek.com/connectors/> STANDARD PLUGS AND CONNECTORS CAN BE SEEN ONLINE AT <https://www.globtek.com/connectors/> ACTUAL CONNECTORS, OVERMOLDS, FERRITES MAY VARY SLIGHTLY FROM THE PICTURE BELOW DIMENSIONS ARE IN MM UNLESS SPECIFIED OTHERWISE

Footnote:

GlobTek Inc. will not be liable for the safety and performance of these power supplies if unauthorized access and repair occurs. End user should consult applicable UL, CSA or EN standards for proper installation instruction.

Limitation of Use:

GlobTek products are intended for use with commercial, medical, and/or industrial equipment only. GlobTek product are not authorized for use as mission critical components in life support hazardous environment, nuclear or aircraft applications without prior written approval from the CEO of GlobTek Inc.

Contents of this document are subject to change without prior notice.

GlobTek, Inc. www.globtek.com 186 Veterans Drive, Northvale, NJ 07647 Tel. (201) 784-1000 Fax (201) 784-0111	Drawing Title: NEMA 5-15P (TYPE B) 2 CONDUCTOR + GROUND PLUG to IEC60320 C13 2 CONDUCTORS + GROUND, GT Cable #106: 18 / 3 Conductors, 7.8mm OD, SJT, 60 Degree, 300V, BLK/WHT/GRN, Approvals: UL, CSA or cUL,2440±50mm, GlobTek Black	
	Model No. Power Cord	
	Part No./Ordering No. 3021068F701SW(R)	Rev A

CUSTOMIZED LENGTHS, COLORS, CABLE TYPES, TERMINATIONS/PLUGS/RECEPTACLES AVAILABLE UPON REQUEST. ADDITIONAL PLUG OPTIONS ARE AVAILABLE AT <https://www.globtek.com/connectors/> STANDARD PLUGS AND CONNECTORS CAN BE SEEN ONLINE AT <https://www.globtek.com/connectors/> ACTUAL CONNECTORS, OVERMOLDS, FERRITES MAY VARY SLIGHTLY FROM THE PICTURE BELOW DIMENSIONS ARE IN MM UNLESS SPECIFIED OTHERWISE

Cordset Information:
CordsetColor:GlobTek Black
Cord Length (mm):2440±50

NOTES:

SWITCH IS # 303 OR EQUAL, UL,CSA/cUL, RATING 3A/120V

GlobTek, Inc. www.globtek.com 186 Veterans Drive, Northvale, NJ 07647 Tel. (201) 784-1000 Fax (201) 784-0111	Drawing Title: NEMA 5-15P (TYPE B) 2 CONDUCTOR + GROUND PLUG to IEC60320 C13 2 CONDUCTORS + GROUND, GT Cable #106: 18 / 3 Conductors, 7.8mm OD, SJT, 60 Degree, 300V, BLK/WHT/GRN, Approvals: UL, CSA or cUL,2440±50mm, GlobTek Black
	Model No. Power Cord
Part No./Ordering No. 3021068F701SW(R)	Rev A

CUSTOMIZED LENGTHS, COLORS, CABLE TYPES, TERMINATIONS/PLUGS/RECEPTACLES AVAILABLE UPON REQUEST. ADDITIONAL PLUG OPTIONS ARE AVAILABLE AT <https://www.globtek.com/connectors/> STANDARD PLUGS AND CONNECTORS CAN BE SEEN ONLINE AT <https://www.globtek.com/connectors/> ACTUAL CONNECTORS, OVERMOLDS, FERRITES MAY VARY SLIGHTLY FROM THE PICTURE BELOW DIMENSIONS ARE IN MM UNLESS SPECIFIED OTHERWISE

END A

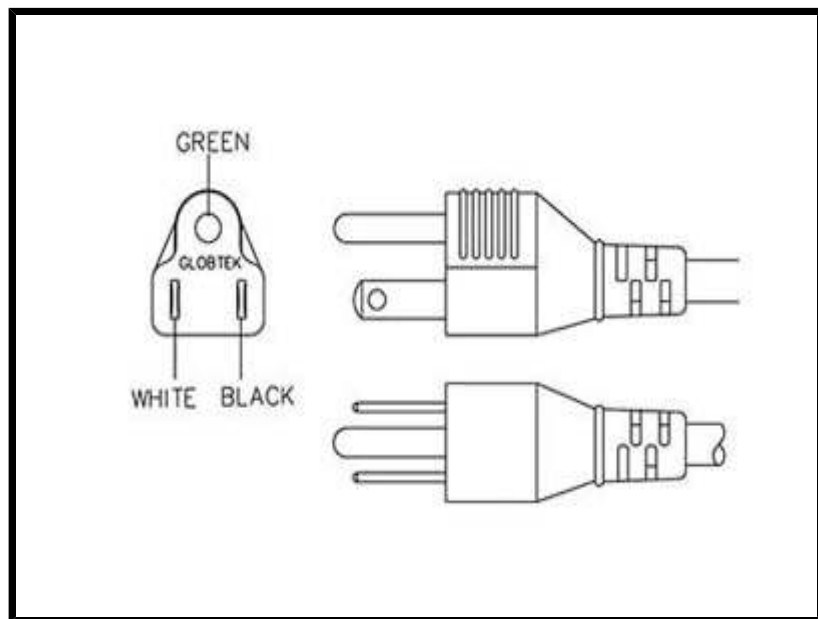

END B

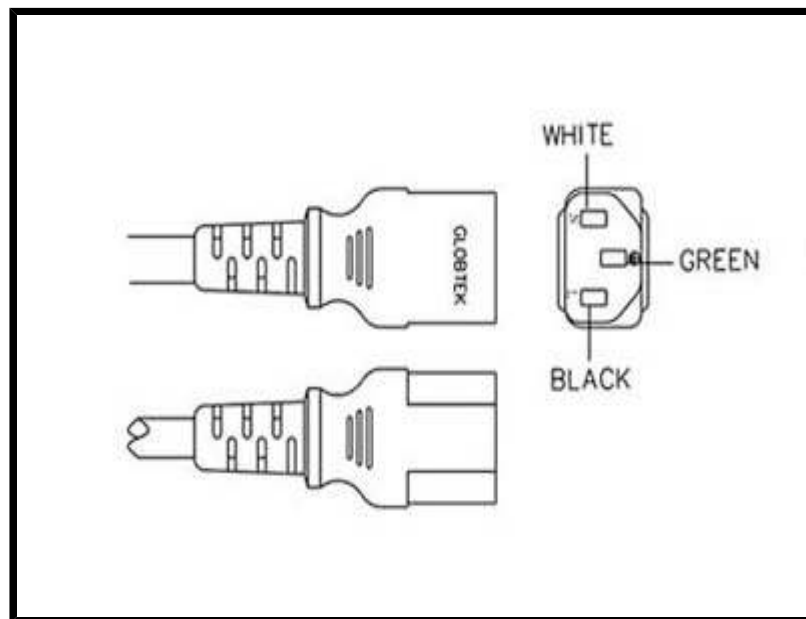

GlobTek, Inc. www.globtek.com 186 Veterans Drive, Northvale, NJ 07647 Tel. (201) 784-1000 Fax (201) 784-0111	Drawing Title: NEMA 5-15P (TYPE B) 2 CONDUCTOR + GROUND PLUG to IEC60320 C13 2 CONDUCTORS + GROUND, GT Cable #106: 18 / 3 Conductors, 7.8mm OD, SJT, 60 Degree, 300V, BLK/WHT/GRN, Approvals: UL, CSA or cUL, 2440±50mm, GlobTek Black
	Model No. Power Cord
Part No./Ordering No. 3021068F701SW(R)	Rev A

CUSTOMIZED LENGTHS, COLORS, CABLE TYPES, TERMINATIONS/PLUGS/RECEPTACLES AVAILABLE UPON REQUEST. ADDITIONAL PLUG OPTIONS ARE AVAILABLE AT <https://www.globtek.com/connectors/> STANDARD PLUGS AND CONNECTORS CAN BE SEEN ONLINE AT <https://www.globtek.com/connectors/> ACTUAL CONNECTORS, OVERMOLDS, FERRITES MAY VARY SLIGHTLY FROM THE PICTURE BELOW DIMENSIONS ARE IN MM UNLESS SPECIFIED OTHERWISE

CABLE IMAGE

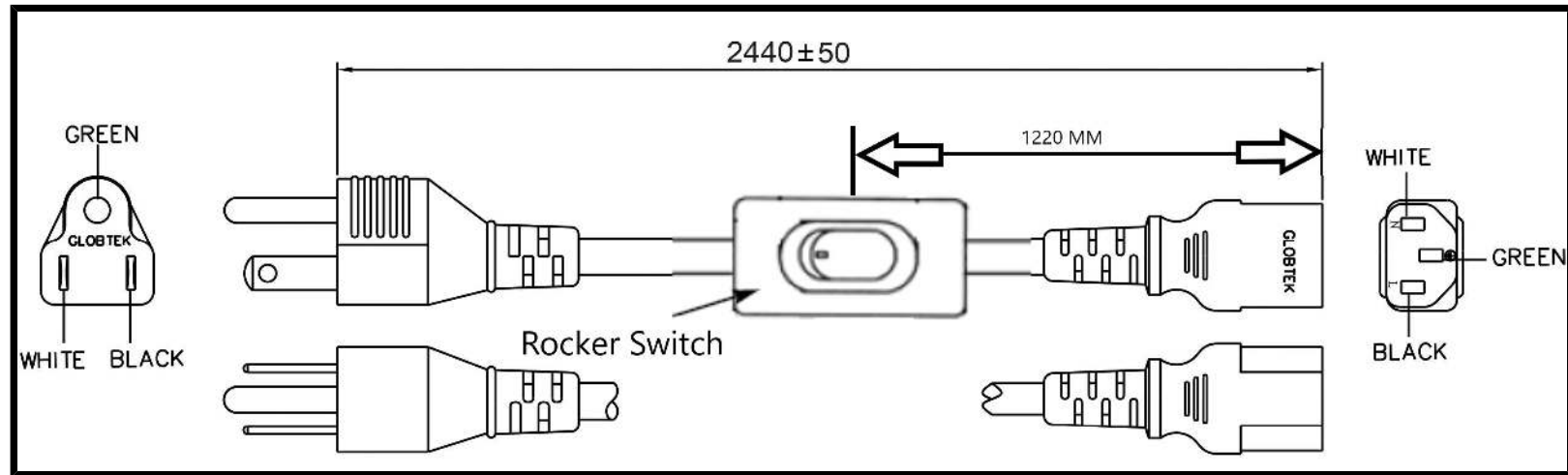



GlobTek, Inc. www.globtek.com 186 Veterans Drive, Northvale, NJ 07647 Tel. (201) 784-1000 Fax (201) 784-0111	Drawing Title: NEMA 5-15P (TYPE B) 2 CONDUCTOR + GROUND PLUG to IEC60320 C13 2 CONDUCTORS + GROUND, GT Cable #106: 18 / 3 Conductors, 7.8mm OD, SJT, 60 Degree, 300V, BLK/WHT/GRN, Approvals: UL, CSA or cUL,2440±50mm, GlobTek Black	
	Model No. Power Cord	
Part No./Ordering No. 3021068F701SW(R)		Rev A

CUSTOMIZED LENGTHS, COLORS, CABLE TYPES, TERMINATIONS/PLUGS/RECEPTACLES AVAILABLE UPON REQUEST. ADDITIONAL PLUG OPTIONS ARE AVAILABLE AT <https://www.globtek.com/connectors/> STANDARD PLUGS AND CONNECTORS CAN BE SEEN ONLINE AT <https://www.globtek.com/connectors/> ACTUAL CONNECTORS, OVERMOLDS, FERRITES MAY VARY SLIGHTLY FROM THE PICTURE BELOW DIMENSIONS ARE IN MM UNLESS SPECIFIED OTHERWISE

End A Code:302 Description:NEMA 5-15P (TYPE B) 2 CONDUCTOR + GROUND PLUG Rating (V):125 Rating (A):15,0 Gender:Male Overmolded:Yes	Cable Code:106 Description:GT Cable #106: 18 / 3 Conductors, 7.8mm OD, SJT, 60 Degree, 300V, BLK/WHT/GRN, Approvals: UL, CSA or cUL Color:GlobTek Black Wire Gauge(AWG):18 Cond:3 Type:SJT Temperature:60 Amps:10 Volts:300 OD:7.8 ConductorsColors:BLK/WHT/GRN	End B Code:701 Description:IEC60320 C13 2 CONDUCTORS + GROUND Rating (V):250 Rating (A):15,0 Gender:Female Overmolded:Yes
--	--	---

Overall cable rating:10A / 125V

Plug Approvals	Cable Approvals	Connector Approvals
----------------	-----------------	---------------------

 UL 817 LINK TO CERT	UL/CUL	 UL 817 LINK TO CERT	UL/CUL	 UL 817 LINK TO CERT	UL/CUL
--	--------	--	--------	--	--------

GlobTek, Inc. www.globtek.com 186 Veterans Drive, Northvale, NJ 07647 Tel. (201) 784-1000 Fax (201) 784-0111	Drawing Title: NEMA 5-15P (TYPE B) 2 CONDUCTOR + GROUND PLUG to IEC60320 C13 2 CONDUCTORS + GROUND, GT Cable #106: 18 / 3 Conductors, 7.8mm OD, SJT, 60 Degree, 300V, BLK/WHT/GRN, Approvals: UL, CSA or cUL,2440±50mm, GlobTek Black	
	Model No. Power Cord	
	Part No./Ordering No. 3021068F701SW(R)	Rev A

CUSTOMIZED LENGTHS, COLORS, CABLE TYPES, TERMINATIONS/PLUGS/RECEPTACLES AVAILABLE UPON REQUEST. ADDITIONAL PLUG OPTIONS ARE AVAILABLE AT <https://www.globtek.com/connectors/> STANDARD PLUGS AND CONNECTORS CAN BE SEEN ONLINE AT <https://www.globtek.com/connectors/> ACTUAL CONNECTORS, OVERMOLDS, FERRITES MAY VARY SLIGHTLY FROM THE PICTURE BELOW DIMENSIONS ARE IN MM UNLESS SPECIFIED OTHERWISE

Hanking:250
 Description:250 +/- 30mm
 Image:

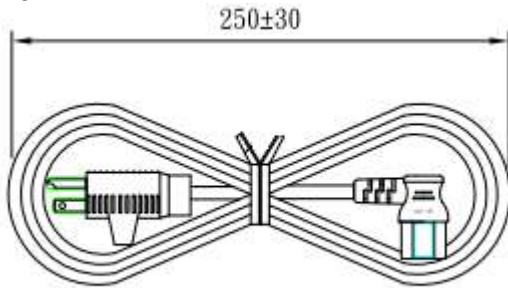

Notes/Modifications/Customizations (notes in this section supersede the values shown in the standard spec):