

Fast Recovery Diodes (T-Modules), 40 A/70 A/85 A



D-55

FEATURES

- Fast recovery time characteristics
- Electrically isolated base plate
- 3500 V_{RMS} isolating voltage
- Standard JEDEC package
- Simplified mechanical designs, rapid assembly
- Large creepage distances
- UL E78996 approved 
- Compliant to RoHS directive 2002/95/EC
- Designed and qualified for industrial level



RoHS
COMPLIANT

DESCRIPTION

The series of T-modules uses fast recovery power diodes in a single diode configuration. The semiconductors are electrically isolated from the metal base, allowing common heatsink and compact assemblies to be built.

These single diode modules can be used in conjunction with the thyristor modules as a freewheel diode. Application includes self-commutated inverters, DC choppers, motor control, inductive heating and electronic welders. These modules are intended for those applications where very fast recovery characteristics are required and for general power switching applications.

PRODUCT SUMMARY

$I_{F(AV)}$	40 A/70 A/85 A
Type	Modules - Diode, Fast

MAJOR RATINGS AND CHARACTERISTICS

SYMBOL	CHARACTERISTICS	T40HFL	T70HFL	T85HFL	UNITS
$I_{F(AV)}$		40	70	85	A
$I_{F(RMS)}$		63	110	133	A
I_{FSM}	50 Hz	475	830	1300	A
	60 Hz	500	870	1370	
I^2t	50 Hz	1130	3460	8550	A ² s
	60 Hz	1030	3160	7810	
V_{RRM}	Range	100 to 1000			V
t_{rr}	Range	200 to 1000			ns
T_J	Range	- 40 to 125			°C

T40HFL, T70HFL, T85HFL Series



Vishay Semiconductors

Fast Recovery Diodes
(T-Modules), 40 A/70 A/85 A

ELECTRICAL SPECIFICATIONS

VOLTAGE RATINGS					
TYPE NUMBER	VOLTAGE CODE	t_{rr} CODE	V_{RRM} , MAXIMUM REPETITIVE PEAK REVERSE VOLTAGE V	V_{RSM} , MAXIMUM NON-REPETITIVE PEAK REVERSE VOLTAGE V	I_{RRM} MAXIMUM AT $T_J = 25^\circ\text{C}$ μA
T40HFL.. T70HFL.. T85HFL..	10	S02, S05, S10	100	150	100
	20	S02, S05, S10	200	300	
	40	S02, S05, S10	400	500	
	60	S02, S05, S10	600	700	
	80	S05, S10	800	900	
	100	S05, S10	1000	1100	

FORWARD CONDUCTION								
PARAMETER	SYMBOL	TEST CONDITIONS			T40HFL	T70HFL	T85HFL	UNITS
Maximum average forward current at case temperature	$I_{F(AV)}$	180° conduction, half sine wave			40	70	85	A
					70			°C
Maximum RMS forward current	$I_{F(RMS)}$				63	110	133	A
Maximum peak, one-cycle forward, non-repetitive surge current	I_{FSM}	t = 10 ms	No voltage reappplied	Sinusoidal half wave, initial $T_J = T_J$ maximum	475	830	1300	A
		t = 8.3 ms			500	870	1370	
		t = 10 ms	100 % V_{RRM} reappplied		400	700	1100	
		t = 8.3 ms			420	730	1150	
Maximum I^2t for fusing	I^2t	t = 10 ms	No voltage reappplied		1130	3460	8550	A ² s
		t = 8.3 ms			1030	3160	7810	
		t = 10 ms	100 % V_{RRM} reappplied		800	2450	6050	
		t = 8.3 ms			730	2230	5520	
Maximum $I^2\sqrt{t}$ for fusing	$I^2\sqrt{t}$	t = 0.1 ms to 10 ms, no voltage reappplied			11 300	34 600	85 500	A ² √s
Low level value of threshold voltage	$V_{F(TO)1}$	$T_J = 25^\circ\text{C}$, $(16.7\% \times \pi \times I_{F(AV)} < I < \pi \times I_{F(AV)})$			0.82	0.87	0.84	V
High level value of threshold voltage	$V_{F(TO)2}$	$T_J = 25^\circ\text{C}$, $(I > \pi \times I_{F(AV)})$			0.84	0.90	0.86	
Low level value of forward slope resistance	r_{f1}	$T_J = 25^\circ\text{C}$, $(16.7\% \times \pi \times I_{F(AV)} < I < \pi \times I_{F(AV)})$			7.0	2.77	2.15	mΩ
High level value of forward slope resistance	r_{f2}	$T_J = 25^\circ\text{C}$, $(I > \pi \times I_{F(AV)})$			6.8	2.67	2.07	
Maximum forward voltage drop	V_{FM}	$I_{FM} = \pi \times I_{F(AV)}$, $T_J = 25^\circ\text{C}$, $t_p = 400 \mu\text{s}$ square wave Average power = $V_{F(TO)} \times I_{F(AV)} + r_f \times (I_{F(RMS)})^2$			1.60	1.73	1.55	V



T40HFL, T70HFL, T85HFL Series

Fast Recovery Diodes
(T-Modules), 40 A/70 A/85 A

Vishay Semiconductors

REVERSE RECOVERY CHARACTERISTICS												
PARAMETER	SYMBOL	TEST CONDITIONS ⁽¹⁾	T40HFL			T70HFL			T85HFL			UNITS
			S02	S05	S10	S02	S05	S10	S02	S05	S10	
Maximum reverse recovery time	t_{rr}	$T_J = 25\text{ }^\circ\text{C}$, $-di_F/dt = 100\text{ A}/\mu\text{s}$ $I_F = 1\text{ A}$ to $V_R = 30\text{ V}$	70	110	270	70	110	270	80	120	290	ns
		$T_J = 25\text{ }^\circ\text{C}$, $-di_F/dt = 25\text{ A}/\mu\text{s}$ $I_{FM} = \pi \times \text{rated } I_{F(AV)}$, $V_R = -30\text{ V}$	200	500	1000	200	500	1000	200	500	1000	
Maximum reverse recovery charge	Q_{rr}	$T_J = 25\text{ }^\circ\text{C}$, $-di_F/dt = 100\text{ A}/\mu\text{s}$ $I_F = 1\text{ A}$ to $V_R = 30\text{ V}$	0.25	0.4	1.35	0.25	0.4	1.35	0.3	0.6	1.6	μC
		$T_J = 25\text{ }^\circ\text{C}$, $-di_F/dt = 25\text{ A}/\mu\text{s}$ $I_{FM} = \pi \times \text{rated } I_{F(AV)}$, $V_R = -30\text{ V}$	0.55	2.0	8.0	0.6	2.1	8.5	0.8	3.5	1.5	

Note

⁽¹⁾ Tested on LEM 300 A diodometer tester

BLOCKING						
PARAMETER	SYMBOL	TEST CONDITIONS	T40HFL	T70HFL	T85HFL	UNITS
Maximum peak reverse leakage current	I_{RRM}	$T_J = 125\text{ }^\circ\text{C}$	20			mA
RMS isolation voltage	V_{ISOL}	50 Hz, circuit to base, all terminals shorted, $T_J = 25\text{ }^\circ\text{C}$, $t = 1\text{ s}$	3500			V

THERMAL AND MECHANICAL SPECIFICATIONS						
PARAMETER	SYMBOL	TEST CONDITIONS	T40HFL	T70HFL	T85HFL	UNITS
Junction operating temperature range	T_J		- 40 to 125			$^\circ\text{C}$
Storage temperature range	T_{Stg}		- 40 to 150			
Maximum internal thermal resistance, junction to case per module	R_{thJC}	DC operation	0.85	0.53	0.46	K/W
Thermal resistance, case to heatsink per module	R_{thCS}	Mounting surface, flat, smooth and greased	0.2			
Mounting torque $\pm 10\%$	base to heatsink	M3.5 mounting screws ⁽¹⁾ Non-lubricated threads	1.3 $\pm 10\%$			Nm
	busbar to terminal	M5 screws terminals Non-lubricated threads	3 $\pm 10\%$			
Approximate weight		See dimensions - link at the end of datasheet	54			g
			19			oz.
Case style			D-55 (T-module)			

Note

⁽¹⁾ A mounting compound is recommended and the torque should be rechecked after a period of about 3 hours to allow for the spread of the compound

ΔR CONDUCTION											
DEVICES	SINUSOIDAL CONDUCTION AT T_J MAXIMUM					RECTANGULAR CONDUCTION AT T_J MAXIMUM					UNITS
	180°	120°	90°	60°	30°	180°	120°	90°	60°	30°	
T40HFL	0.06	0.08	0.10	0.14	0.24	0.05	0.08	0.10	0.15	0.24	K/W
T70HFL	0.05	0.06	0.08	0.11	0.19	0.04	0.06	0.08	0.12	0.19	
T85HFL	0.04	0.05	0.06	0.09	0.15	0.03	0.05	0.07	0.09	0.015	

Note

• The table above shows the increment of thermal resistance R_{thJC} when devices operate at different conduction angles than DC

T40HFL, T70HFL, T85HFL Series

Vishay Semiconductors

Fast Recovery Diodes
(T-Modules), 40 A/70 A/85 A

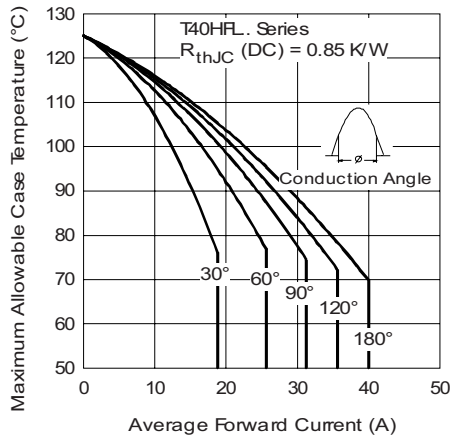

Fig. 1 - Current Ratings Characteristics

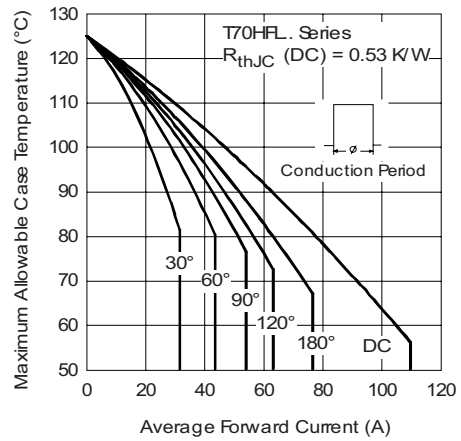

Fig. 4 - Current Ratings Characteristics

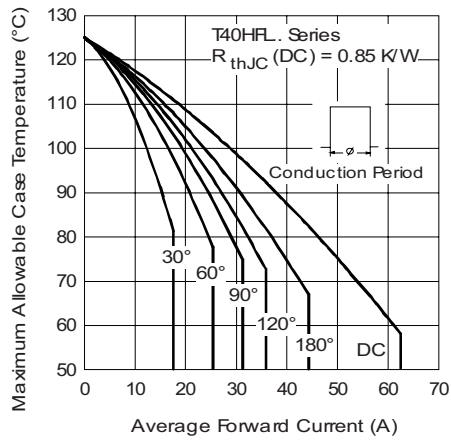

Fig. 2 - Current Ratings Characteristics

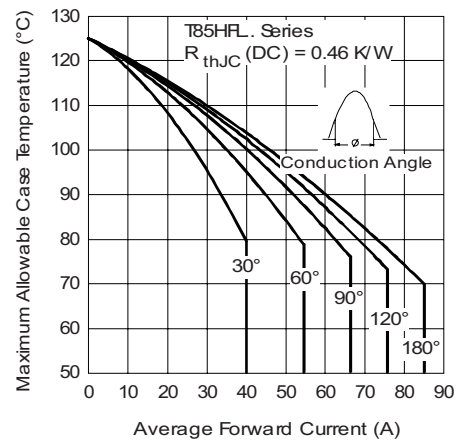

Fig. 5 - Current Ratings Characteristics

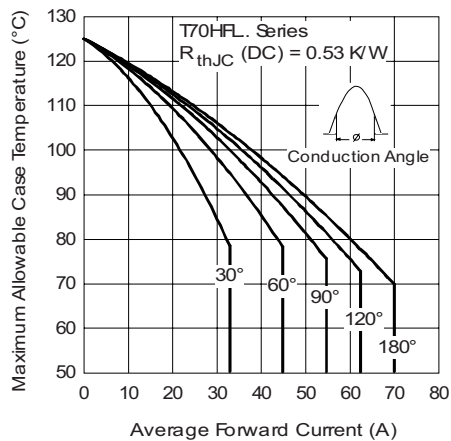

Fig. 3 - Current Ratings Characteristics

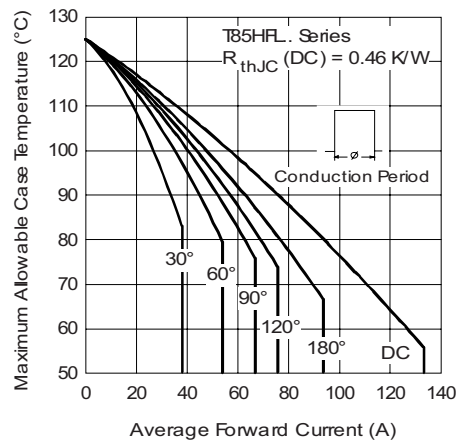

Fig. 6 - Current Ratings Characteristics



T40HFL, T70HFL, T85HFL Series

Fast Recovery Diodes
(T-Modules), 40 A/70 A/85 A

Vishay Semiconductors

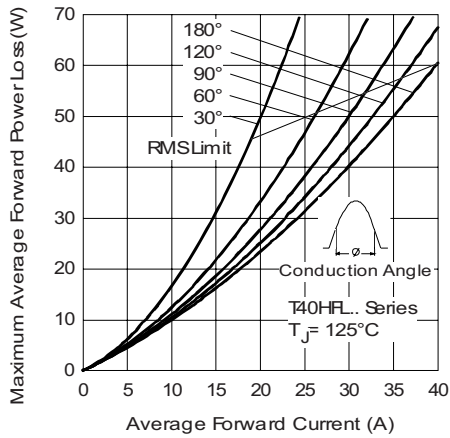

Fig. 7 - Forward Power Loss Characteristics

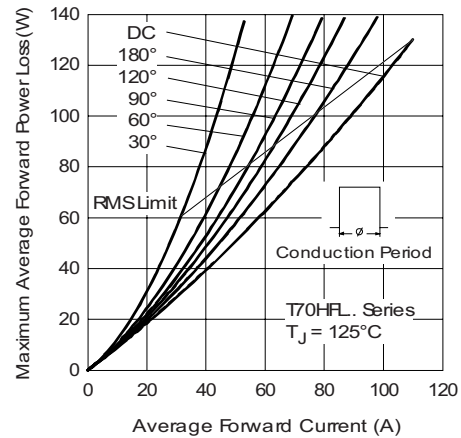

Fig. 10 - Forward Power Loss Characteristics

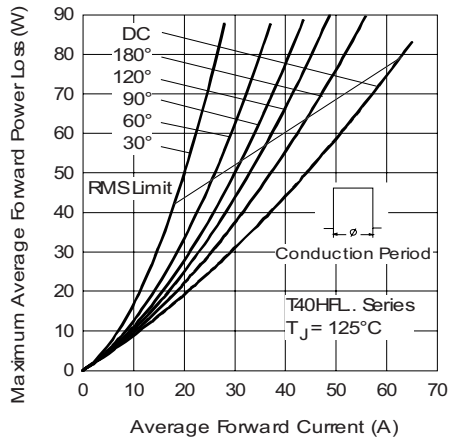

Fig. 8 - Forward Power Loss Characteristics

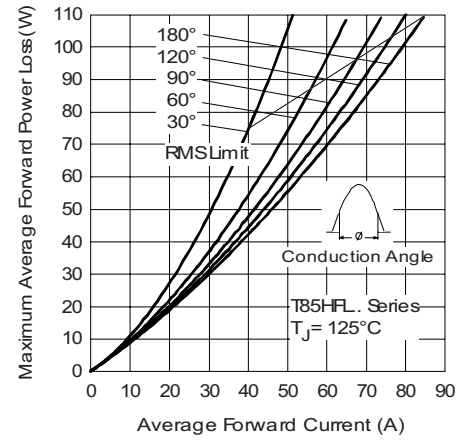

Fig. 11 - Forward Power Loss Characteristics

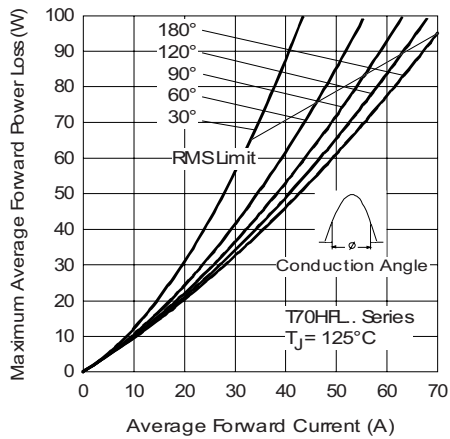

Fig. 9 - Forward Power Loss Characteristics

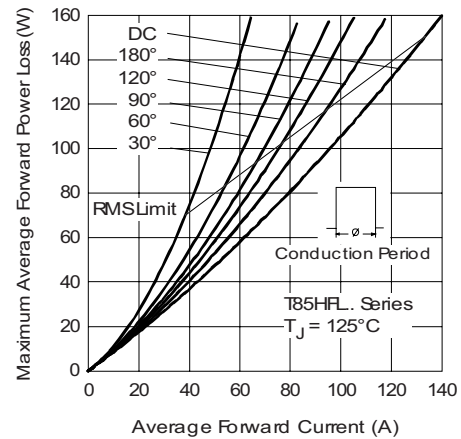

Fig. 12 - Forward Power Loss Characteristics

T40HFL, T70HFL, T85HFL Series



Vishay Semiconductors

Fast Recovery Diodes
(T-Modules), 40 A/70 A/85 A

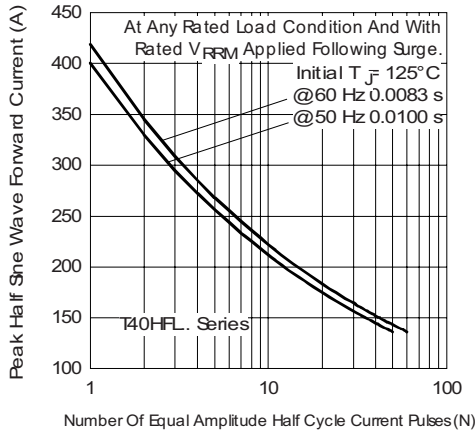

Fig. 13 - Maximum Non-Repetitive Surge Current

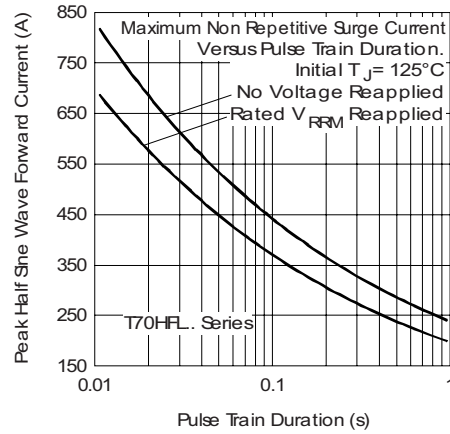

Fig. 16 - Maximum Non-Repetitive Surge Current

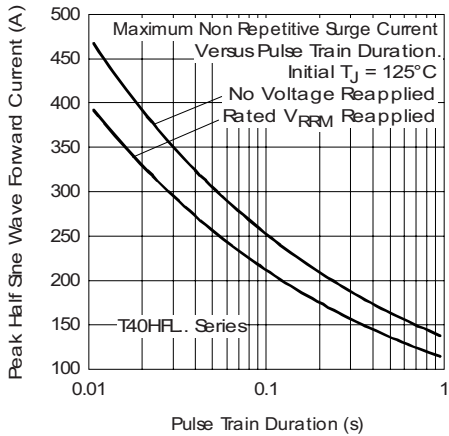

Fig. 14 - Maximum Non-Repetitive Surge Current

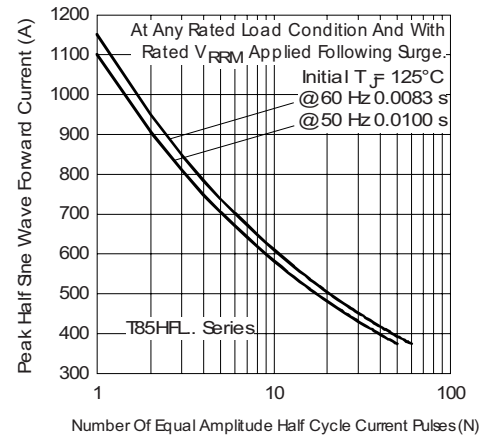

Fig. 17 - Maximum Non-Repetitive Surge Current

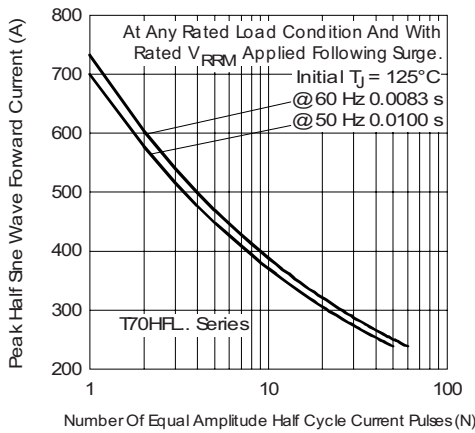

Fig. 15 - Maximum Non-Repetitive Surge Current

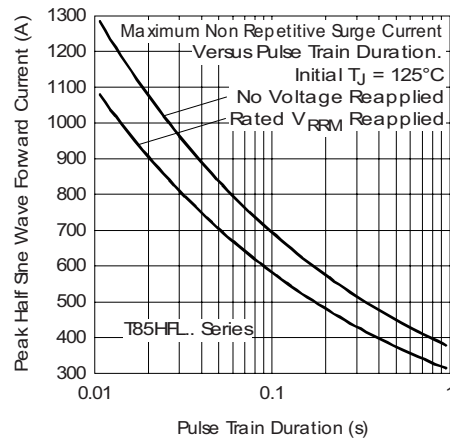

Fig. 18 - Maximum Non-Repetitive Surge Current



T40HFL, T70HFL, T85HFL Series

Fast Recovery Diodes
(T-Modules), 40 A/70 A/85 A

Vishay Semiconductors

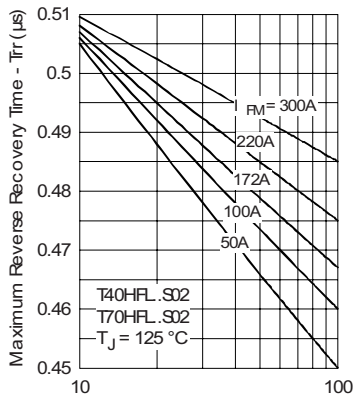

Rate Of Fall Of Forward Current - di/dt (A/µs)

Fig. 19 - Recovery Time Characteristics

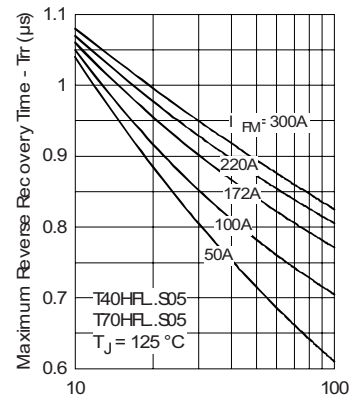

Rate Of Fall Of Forward Current - di/dt (A/µs)

Fig. 22 - Recovery Time Characteristics

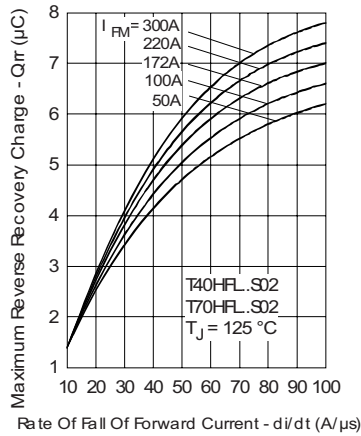

Fig. 20 - Recovery Charge Characteristics

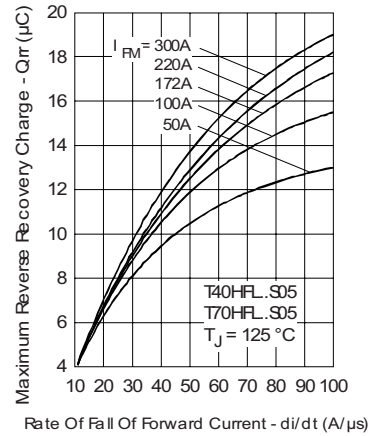

Fig. 23 - Recovery Charge Characteristics

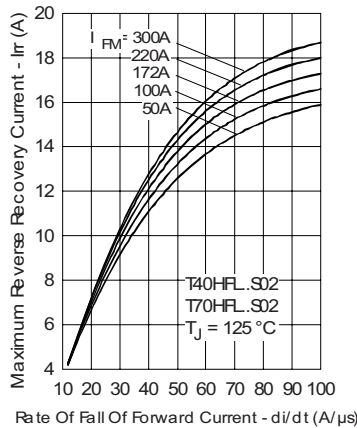

Fig. 21 - Recovery Current Characteristics

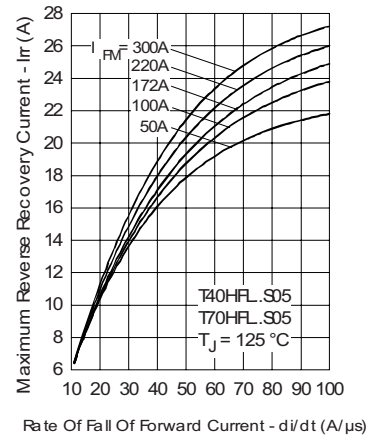

Fig. 24 - Recovery Current Characteristics

T40HFL, T70HFL, T85HFL Series

Vishay Semiconductors

Fast Recovery Diodes
(T-Modules), 40 A/70 A/85 A

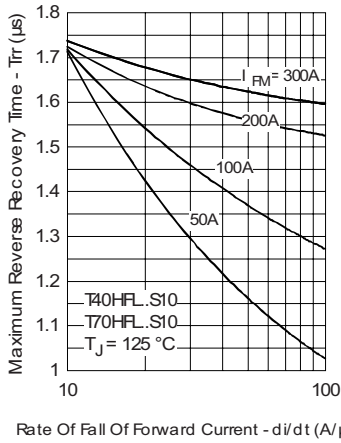

Fig. 25 - Recovery Time Characteristics

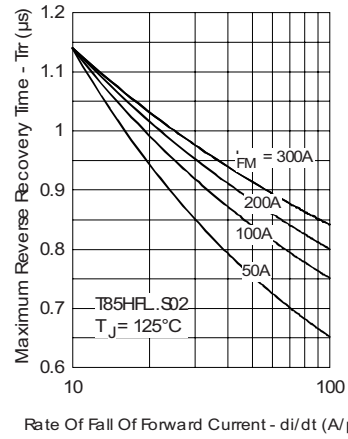

Fig. 28 - Recovery Time Characteristics

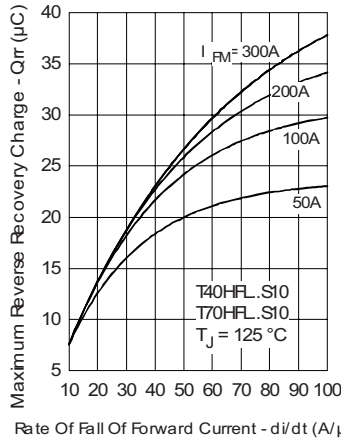

Fig. 26 - Recovery Charge Characteristics

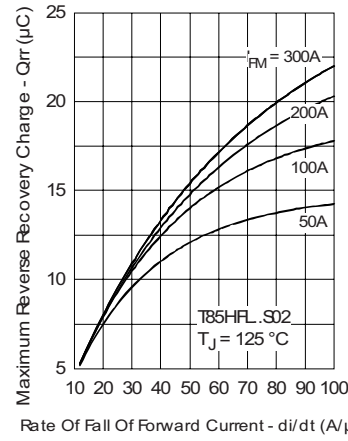

Fig. 29 - Recovery Charge Characteristics

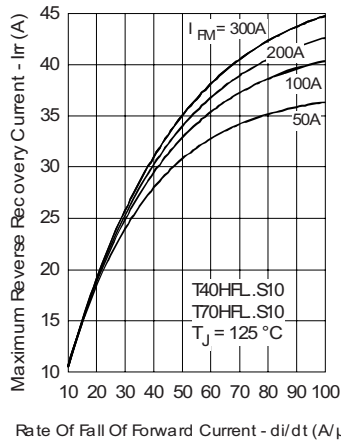

Fig. 27 - Recovery Current Characteristics

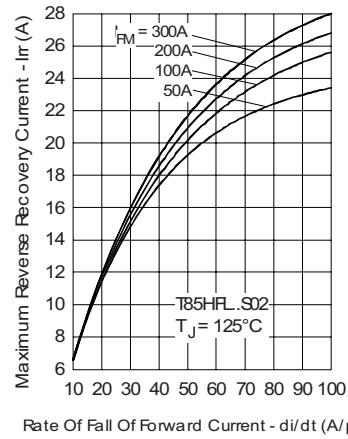

Fig. 30 - Recovery Current Characteristics



T40HFL, T70HFL, T85HFL Series

Fast Recovery Diodes
(T-Modules), 40 A/70 A/85 A

Vishay Semiconductors

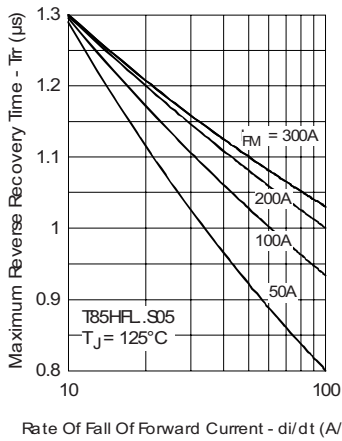

Fig. 31 - Recovery Time Characteristics

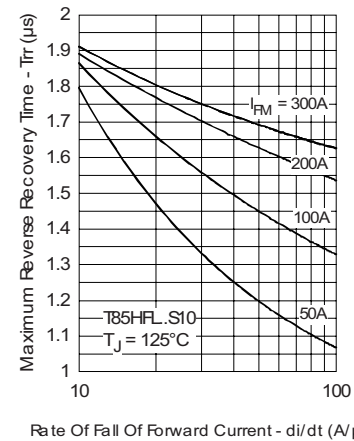

Fig. 34 - Recovery Time Characteristics

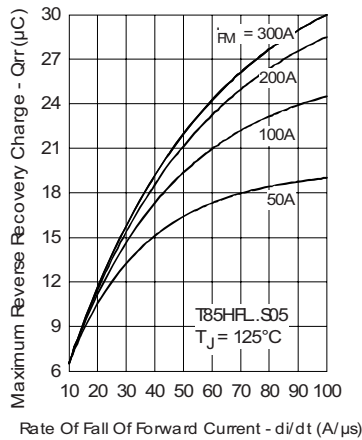

Fig. 32 - Recovery Charge Characteristics

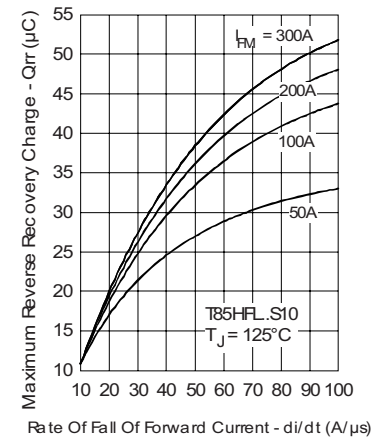

Fig. 35 - Recovery Charge Characteristics

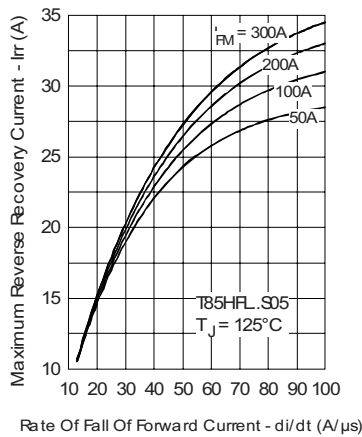

Fig. 33 - Recovery Current Characteristics

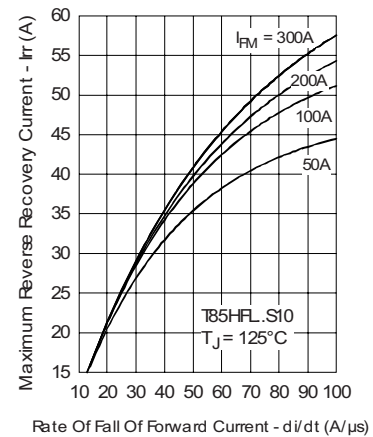

Fig. 36 - Recovery Current Characteristics

T40HFL, T70HFL, T85HFL Series

Vishay Semiconductors

Fast Recovery Diodes
(T-Modules), 40 A/70 A/85 A

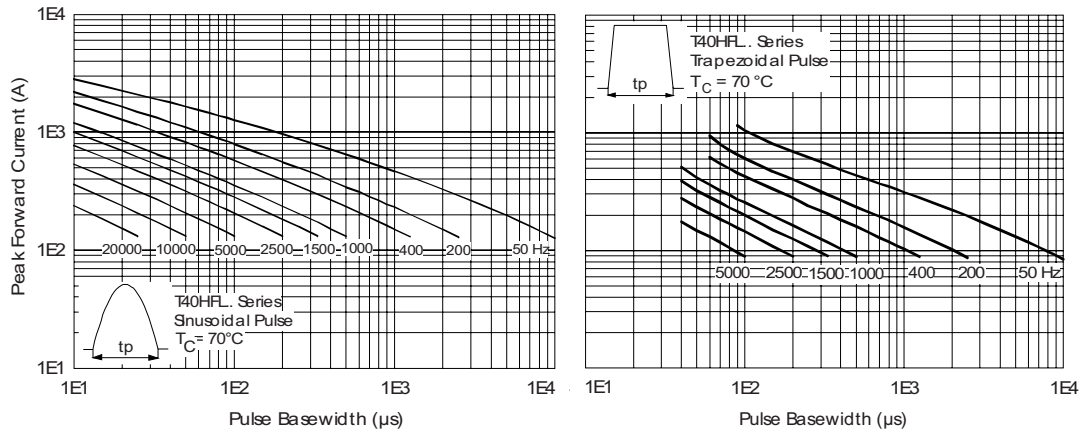

Fig. 37 - Frequency Characteristics

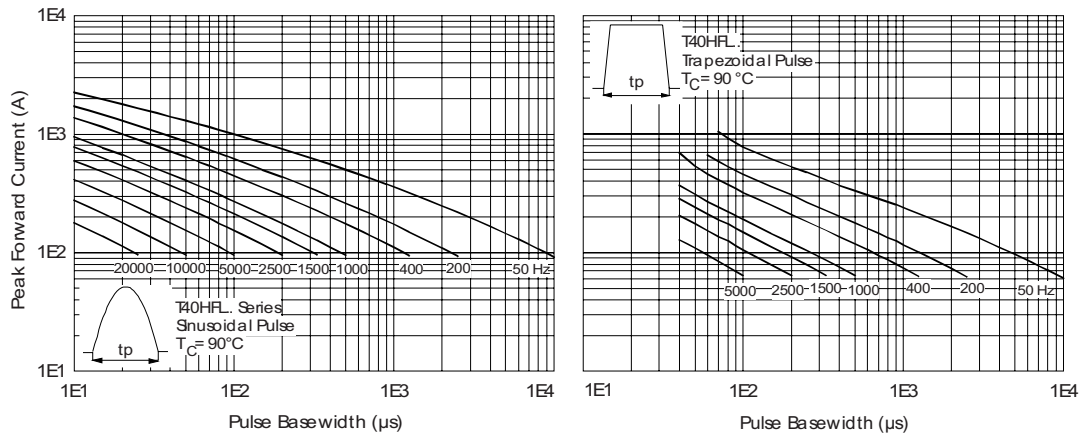

Fig. 38 - Frequency Characteristics

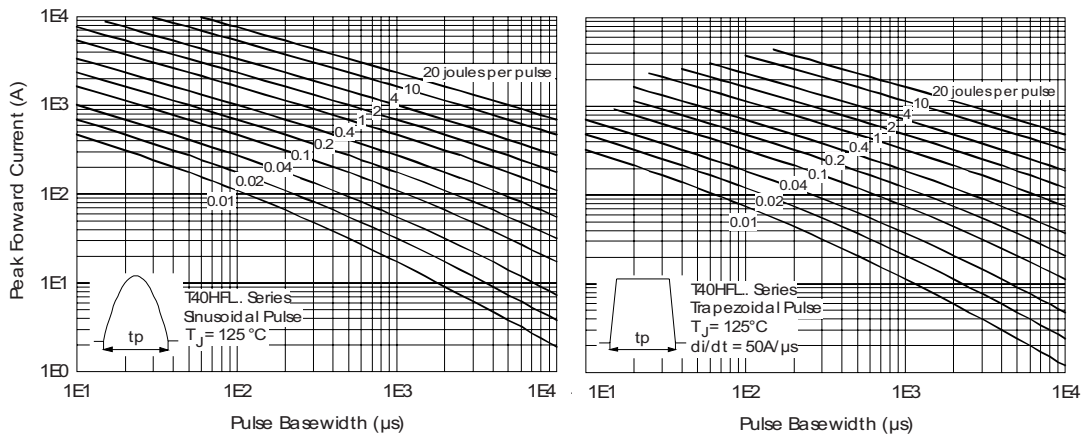

Fig. 39 - Maximum Forward Energy Power Loss Characteristics



T40HFL, T70HFL, T85HFL Series

Fast Recovery Diodes
(T-Modules), 40 A/70 A/85 A

Vishay Semiconductors

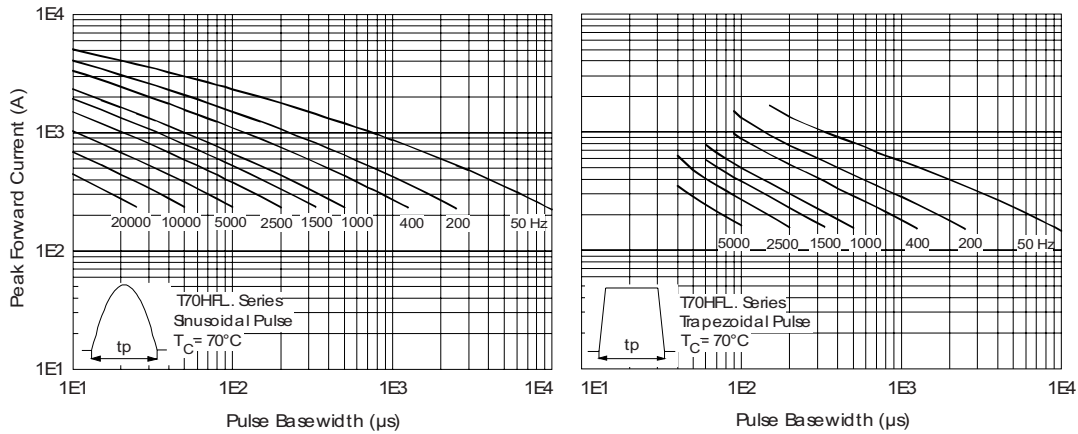

Fig. 40 - Frequency Characteristics

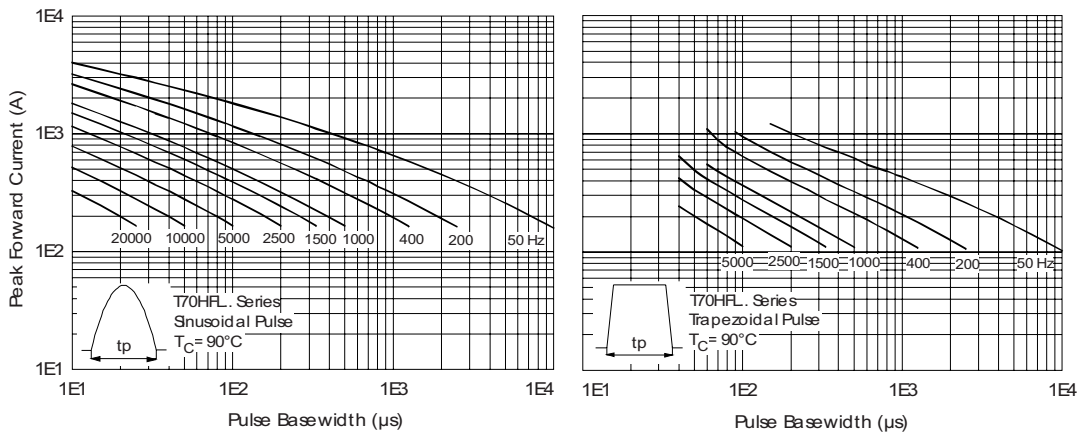

Fig. 41 - Frequency Characteristics

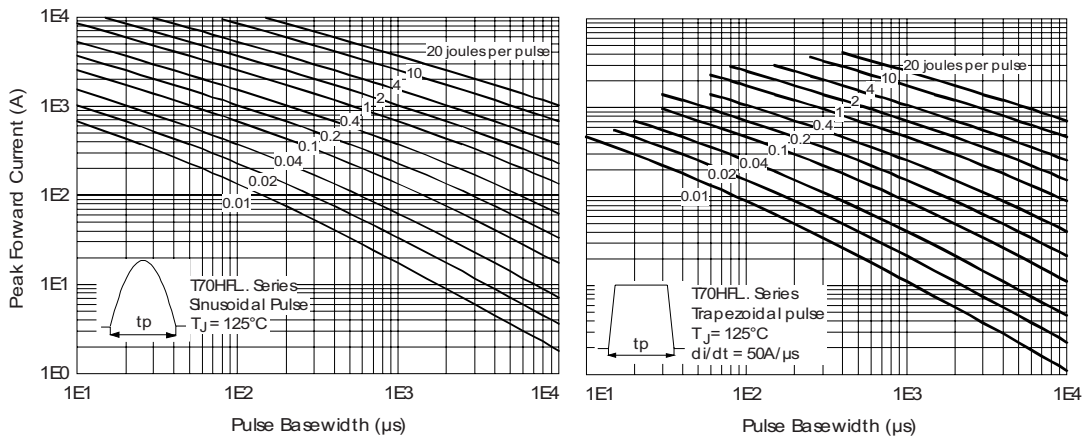

Fig. 42 - Maximum Forward Energy Power Loss Characteristics

T40HFL, T70HFL, T85HFL Series

Vishay Semiconductors

Fast Recovery Diodes
(T-Modules), 40 A/70 A/85 A

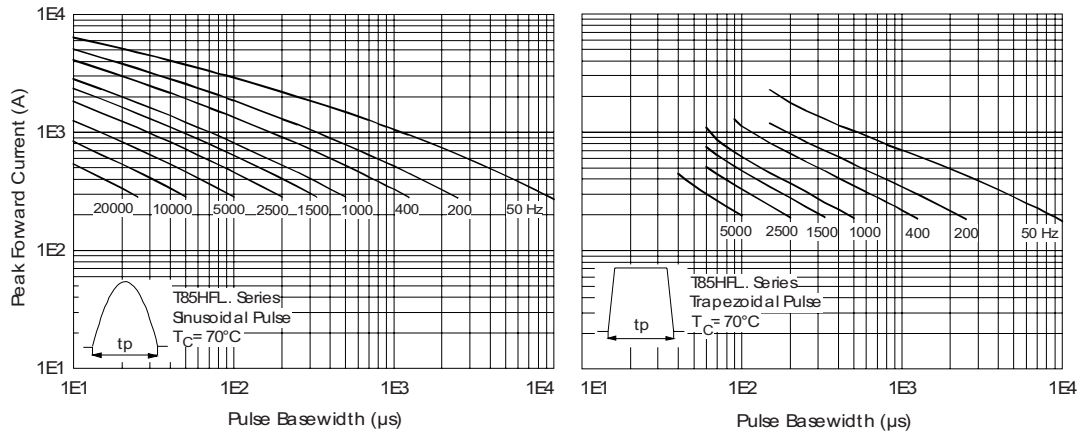

Fig. 43 - Frequency Characteristics

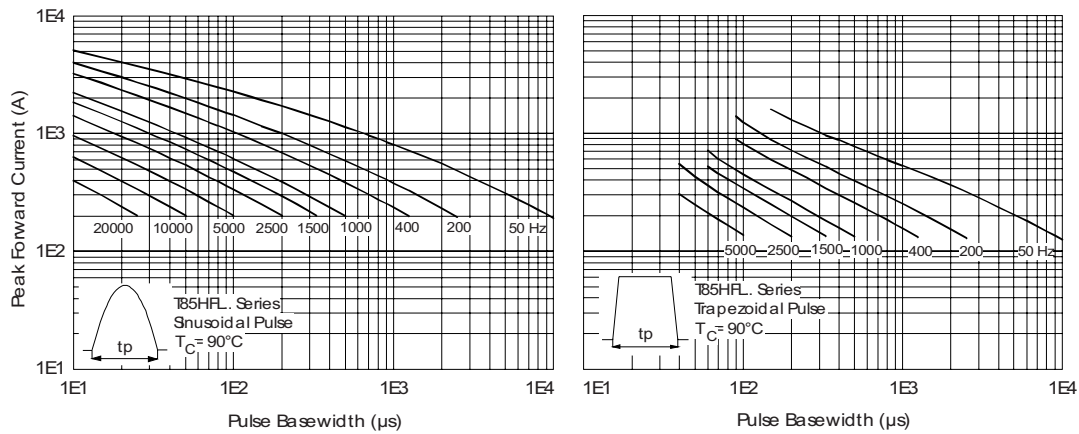

Fig. 44 - Frequency Characteristics

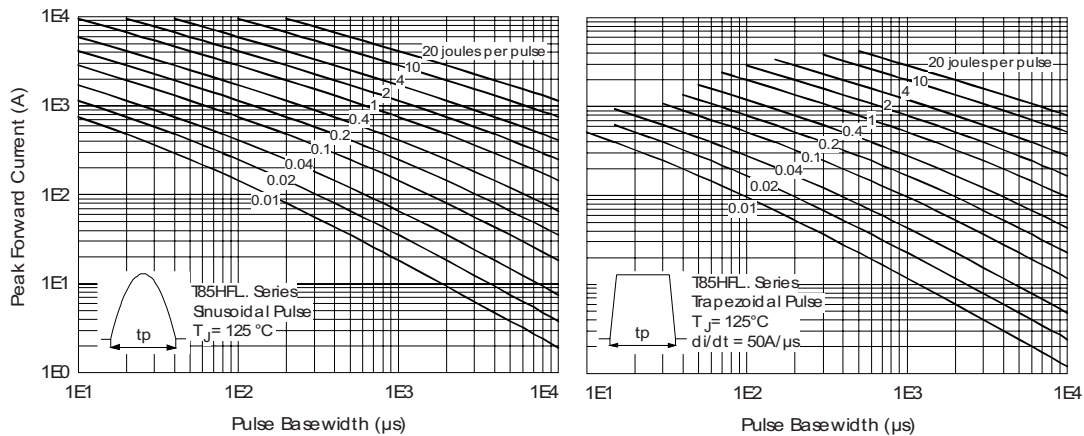

Fig. 45 - Maximum Forward Energy Power Loss Characteristics



T40HFL, T70HFL, T85HFL Series

Fast Recovery Diodes
(T-Modules), 40 A/70 A/85 A

Vishay Semiconductors

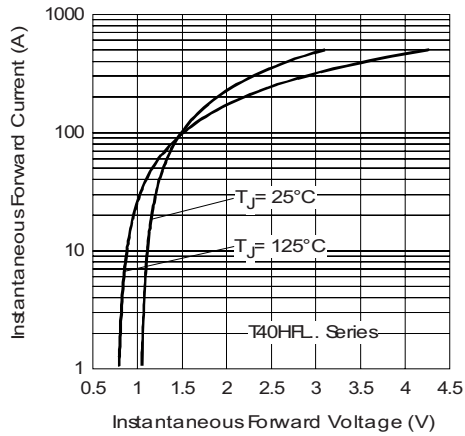

Fig. 46 - Forward Voltage Drop Characteristics

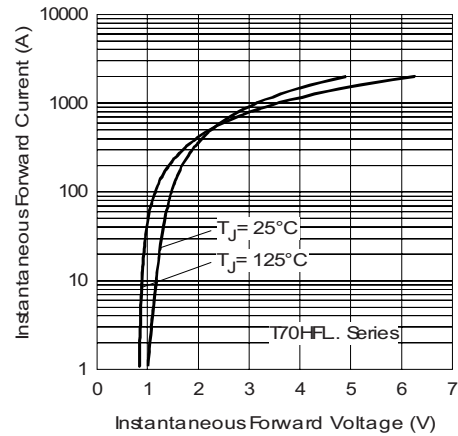

Fig. 47 - Forward Voltage Drop Characteristics

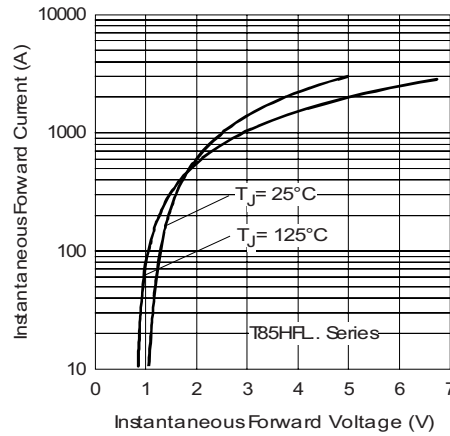

Fig. 48 - Forward Voltage Drop Characteristics

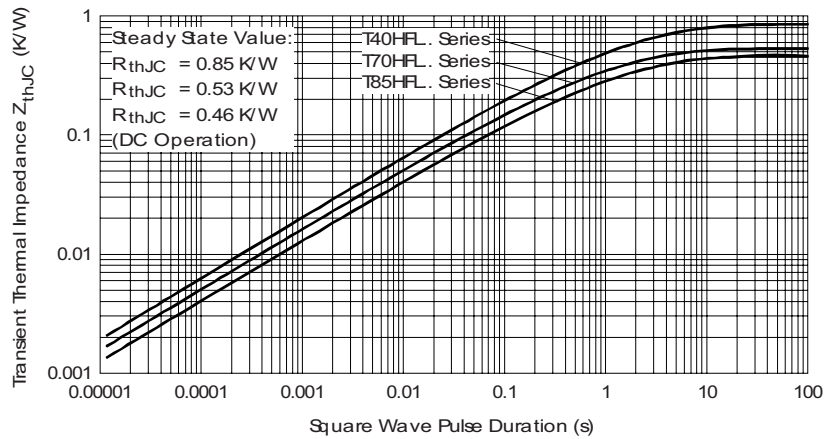

Fig. 49 - Thermal Impedance Z_{thJC} Characteristics

T40HFL, T70HFL, T85HFL Series



Vishay Semiconductors

Fast Recovery Diodes
(T-Modules), 40 A/70 A/85 A

ORDERING INFORMATION TABLE

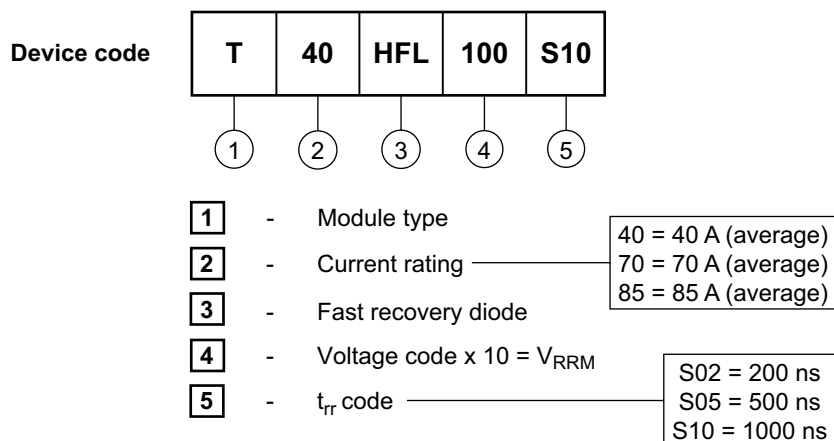

CIRCUIT CONFIGURATION		
CIRCUIT	CIRCUIT CONFIGURATION CODE	CIRCUIT DRAWING
Single switch diode	N/A	

LINKS TO RELATED DOCUMENTS	
Dimensions	www.vishay.com/doc?95313

D-55 T-Module Diode Standard and Fast Recovery

DIMENSIONS in millimeters (inches)

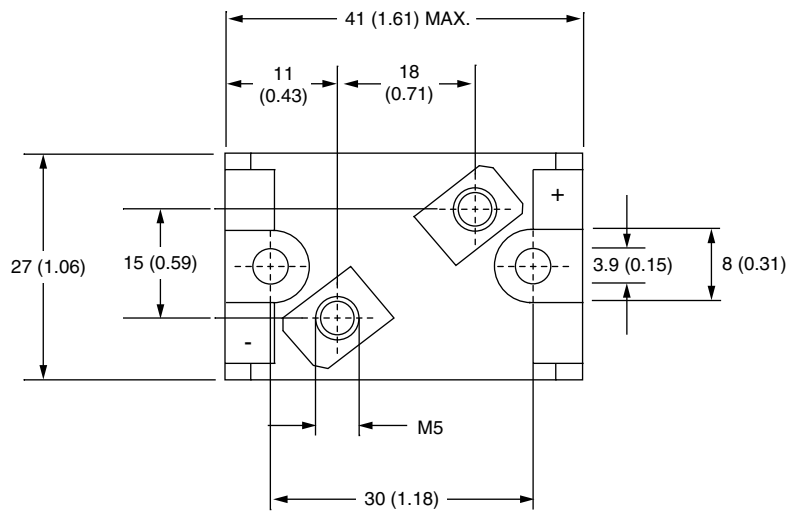
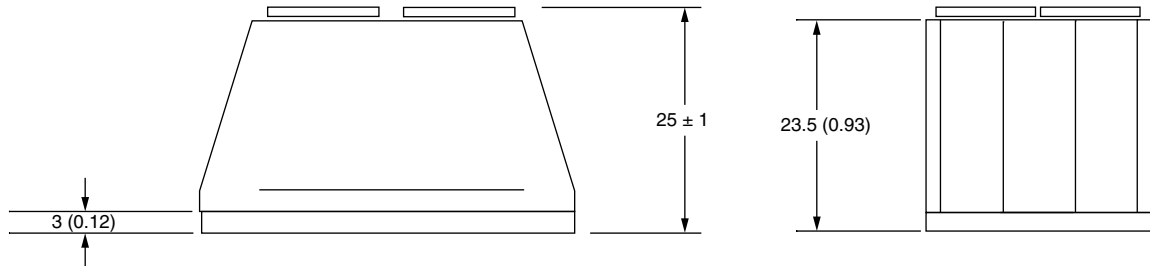



Disclaimer

ALL PRODUCT, PRODUCT SPECIFICATIONS AND DATA ARE SUBJECT TO CHANGE WITHOUT NOTICE TO IMPROVE RELIABILITY, FUNCTION OR DESIGN OR OTHERWISE.

Vishay Intertechnology, Inc., its affiliates, agents, and employees, and all persons acting on its or their behalf (collectively, "Vishay"), disclaim any and all liability for any errors, inaccuracies or incompleteness contained in any datasheet or in any other disclosure relating to any product.

Vishay makes no warranty, representation or guarantee regarding the suitability of the products for any particular purpose or the continuing production of any product. To the maximum extent permitted by applicable law, Vishay disclaims (i) any and all liability arising out of the application or use of any product, (ii) any and all liability, including without limitation special, consequential or incidental damages, and (iii) any and all implied warranties, including warranties of fitness for particular purpose, non-infringement and merchantability.

Statements regarding the suitability of products for certain types of applications are based on Vishay's knowledge of typical requirements that are often placed on Vishay products in generic applications. Such statements are not binding statements about the suitability of products for a particular application. It is the customer's responsibility to validate that a particular product with the properties described in the product specification is suitable for use in a particular application. Parameters provided in datasheets and/or specifications may vary in different applications and performance may vary over time. All operating parameters, including typical parameters, must be validated for each customer application by the customer's technical experts. Product specifications do not expand or otherwise modify Vishay's terms and conditions of purchase, including but not limited to the warranty expressed therein.

Except as expressly indicated in writing, Vishay products are not designed for use in medical, life-saving, or life-sustaining applications or for any other application in which the failure of the Vishay product could result in personal injury or death. Customers using or selling Vishay products not expressly indicated for use in such applications do so at their own risk and agree to fully indemnify and hold Vishay and its distributors harmless from and against any and all claims, liabilities, expenses and damages arising or resulting in connection with such use or sale, including attorneys fees, even if such claim alleges that Vishay or its distributor was negligent regarding the design or manufacture of the part. Please contact authorized Vishay personnel to obtain written terms and conditions regarding products designed for such applications.

No license, express or implied, by estoppel or otherwise, to any intellectual property rights is granted by this document or by any conduct of Vishay. Product names and markings noted herein may be trademarks of their respective owners.

Material Category Policy

Vishay Intertechnology, Inc. hereby certifies that all its products that are identified as RoHS-Compliant fulfill the definitions and restrictions defined under Directive 2011/65/EU of The European Parliament and of the Council of June 8, 2011 on the restriction of the use of certain hazardous substances in electrical and electronic equipment (EEE) - recast, unless otherwise specified as non-compliant.

Please note that some Vishay documentation may still make reference to RoHS Directive 2002/95/EC. We confirm that all the products identified as being compliant to Directive 2002/95/EC conform to Directive 2011/65/EU.