

PRECISION 5.0 VOLT MICROPPOWER VOLTAGE REFERENCE

ZR4040-5.0

ISSUE 2 - MARCH 1998

DEVICE DESCRIPTION

The ZR4040-5.0 uses a bandgap circuit design to achieve a precision micropower voltage reference of 5.0 volts. The device is available in small outline surface mount packages, ideal for applications where space saving is important, as well as packages for through hole requirements.

The ZR4040-5.0 design provides a stable voltage without an external capacitor and is stable with capacitive loads. The ZR4040-5.0 is recommended for operation between 60 μ A and 15mA and so is ideally suited to low power and battery powered applications.

Excellent performance is maintained to an absolute maximum of 25mA, however the rugged design and 20 volt processing allows the reference to withstand transient effects and currents up to 200mA. Superior switching capability allows the device to reach stable operating conditions in only a few microseconds.

FEATURES

- Small outline SO8 and SOT23 packages
- TO92 style package
- No stabilising capacitor required
- Typical T_c 20ppm/ $^{\circ}$ C
- Typical slope resistance 0.33 Ω
- 2% and 1% tolerance
- Industrial temperature range
- Operating current 60 μ A to 15mA
- Transient response, stable in less than 10 μ s

APPLICATIONS

- Battery powered and portable equipment.
- Metering and measurement systems.
- Instrumentation.
- Test equipment.
- Data acquisition systems.
- Precision power supplies.

SCHEMATIC DIAGRAM

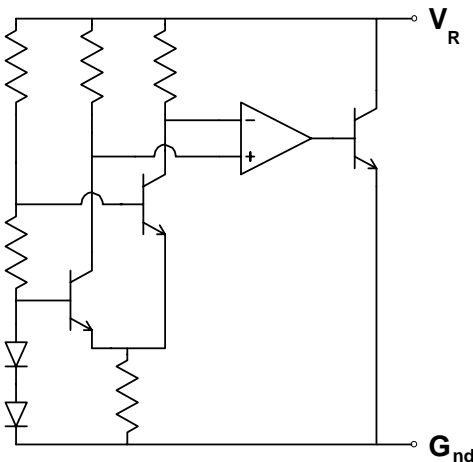

ZR4040-5.0

ABSOLUTE MAXIMUM RATING

| | |
|-----------------------|--------------|
| Reverse Current | 25mA |
| Forward Current | 25mA |
| Operating Temperature | -40 to 85°C |
| Storage Temperature | -55 to 125°C |

Power Dissipation (T_{amb}=25°C)

| | |
|----------------------|-------|
| SOT23 | 330mW |
| SO8 | 625mW |
| E-Line, 3 pin (TO92) | 500mW |

ELECTRICAL CHARACTERISTICS

TEST CONDITIONS (Unless otherwise stated) T_{amb}=25°C

| SYMBOL | PARAMETER | CONDITIONS | LIMITS | | | TOL. % | UNITS |
|------------------|---|--|--------------|------------|--------------|--------|----------|
| | | | MIN | TYP | MAX | | |
| V _R | Reverse Breakdown Voltage | I _R =150μA | 4.95 4.90 | 5.0 5.0 | 5.05 5.10 | 1 2 | V |
| I _{MIN} | Minimum Operating Current | | | 30 | 60 | | μA |
| I _R | Recommended Operating Current | | 0.06 | | 15 | | mA |
| T _C † | Average Reverse Breakdown Voltage Temp. Co. | I _{R(min)} to I _{R(max)} | | 20 | 100 | | ppm/°C |
| R _S § | Slope Resistance | | | 0.33 | 1.5 | | Ω |
| Z _R | Reverse Dynamic Impedance | I _R = 1mA f = 100Hz I _{AC} =0.1 I _R | | 0.4 | 1.0 | | Ω |
| E _N | Wideband Noise Voltage | I _R = 1mA f = 10Hz to 10kHz | | 105 | | | μV (rms) |

$$\dagger T_C = \frac{(V_{R(max)} - V_{R(min)}) \times 1000000}{V_R \times (T_{(max)} - T_{(min)})}$$

Note: V_{R(max)} - V_{R(min)} is the maximum deviation in reference voltage measured over the full operating temperature range.

$$\S R_S = \frac{V_R \text{ Change}(I_R(min) \text{ to } I_R(max))}{I_R(max) - I_R(min)}$$

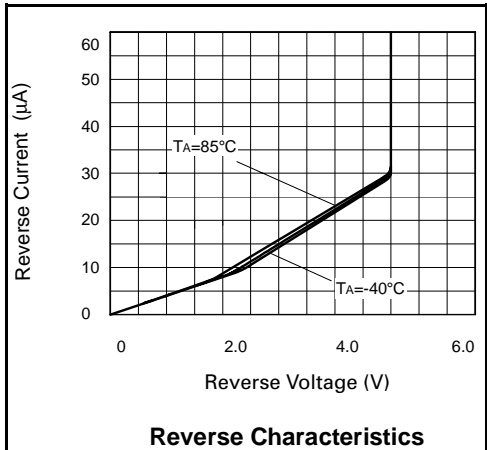

TYPICAL CHARACTERISTICS

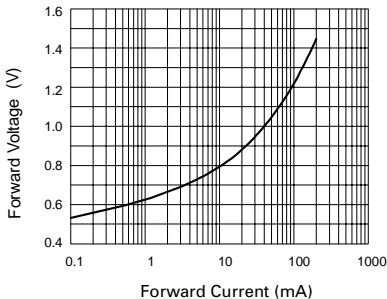

Forward Characteristics

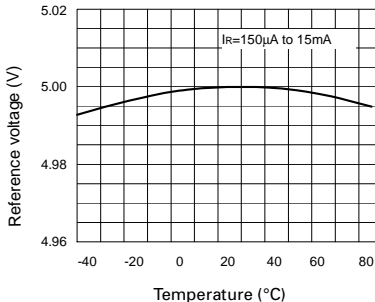

Temperature Drift

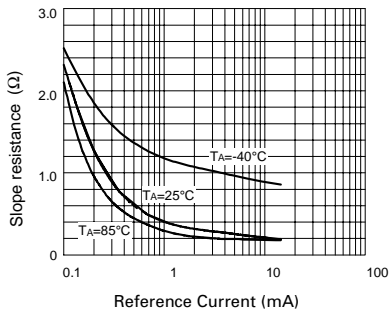

Slope Resistance v Current

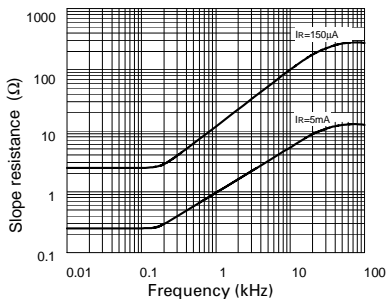

Slope Resistance v Frequency

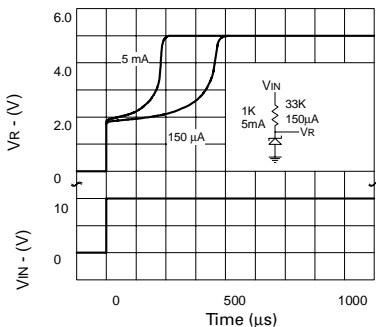

**Transient Response
(Single Pulse)**

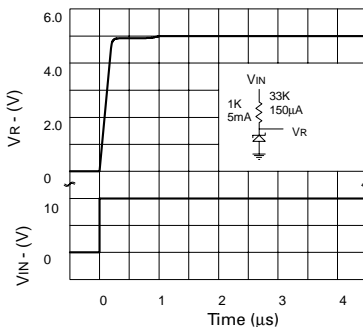

**Transient Response
(Repetitive Pulse)**

ZR4040-5.0

CONNECTION DIAGRAMS

SO8 Package Suffix – N8

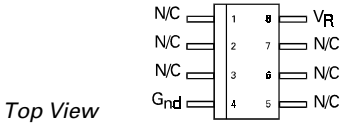

SOT23 Package Suffix – F

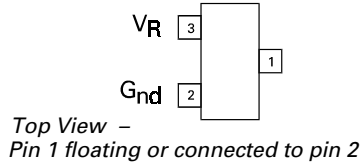

E-Line, 3 pin, Rev Package Suffix – R

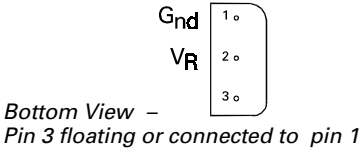

ORDERING INFORMATION

| Part Number | Tol% | Package | Partmark |
|-------------|------|----------|-----------|
| ZR40402F50 | 2 | SOT23 | 50L |
| ZR40401F50 | 1 | SOT23 | 50M |
| ZR40402N850 | 2 | SO8 | ZR4040250 |
| ZR40401N850 | 1 | SO8 | ZR4040150 |
| ZR40402R50 | 2 | E-Line * | ZR4040250 |
| ZR40401R50 | 1 | E-Line * | ZR4040150 |

* E-Line, 3 pin Reversed