

LOC		DJUST		REVISIONS			
P	LTR	DESCRIPTION	DATE	DWN	APVD		
CM	53	E	REV & REDWN PER EC OL30-0073-96	10-11-96	JH RS		

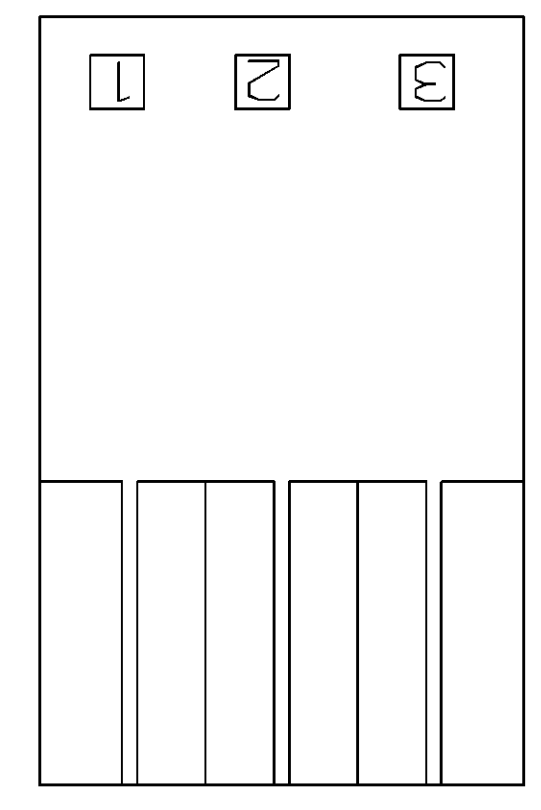

△1 MATERIAL: NYLON UL94V-2 (NATURAL).
 △2 MARKING FOR UL LOGO AND CSA LOGO LOCATED APPROXIMATELY AS SHOWN.

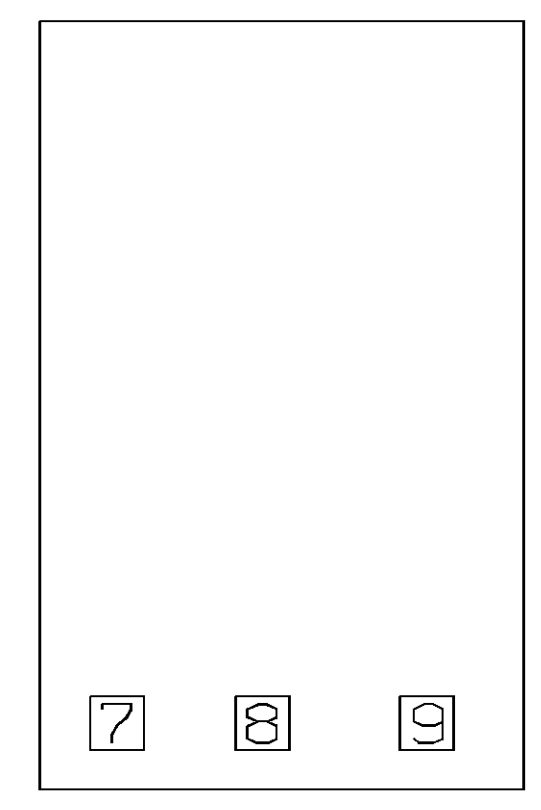
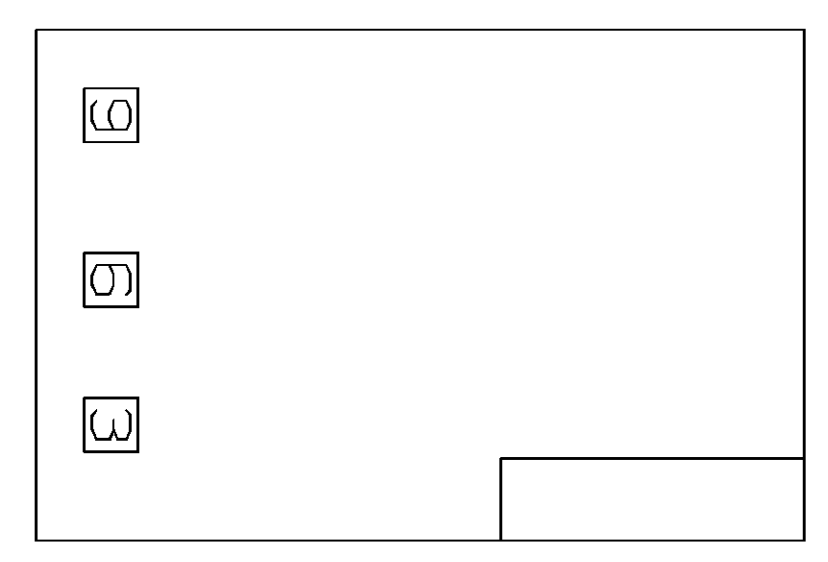
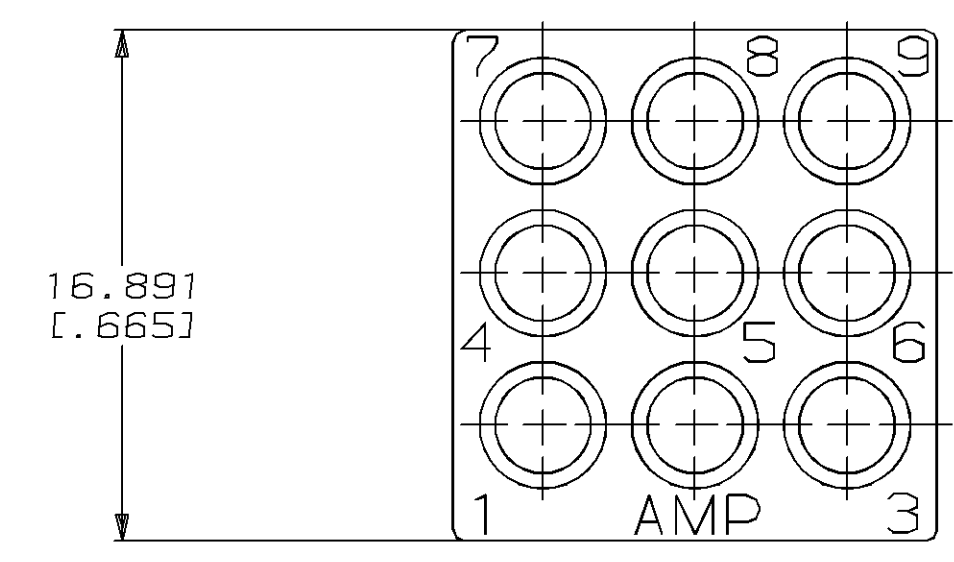
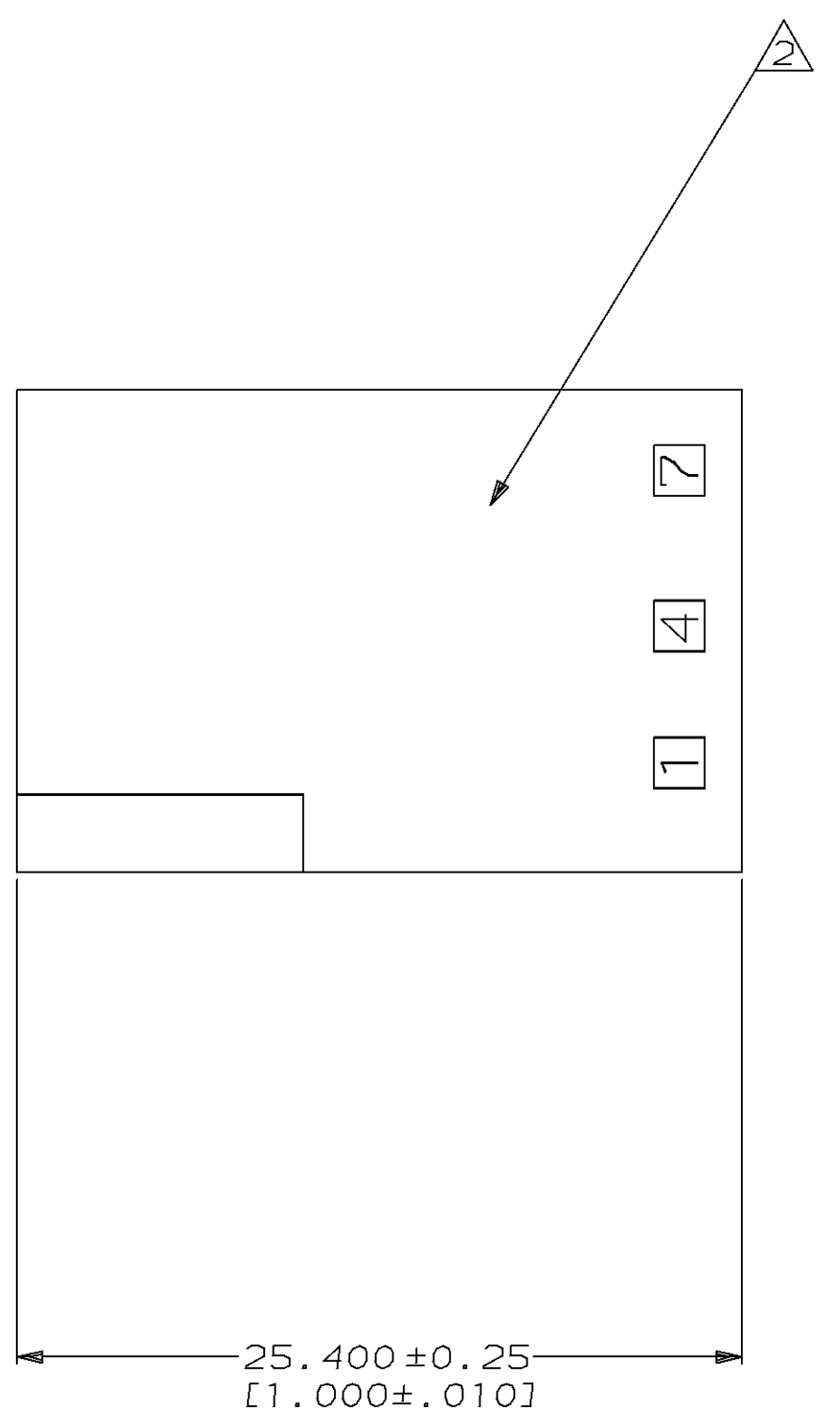
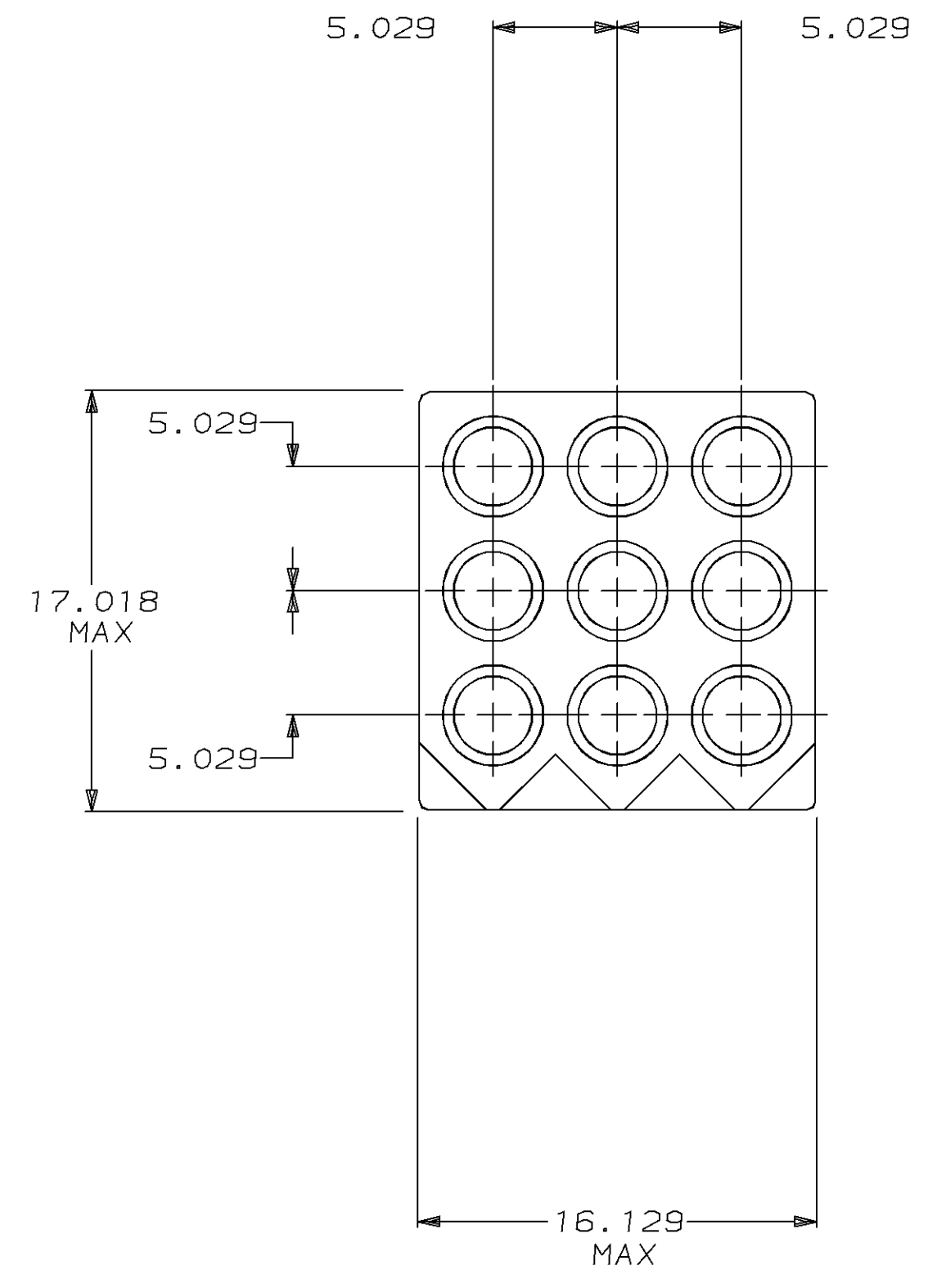
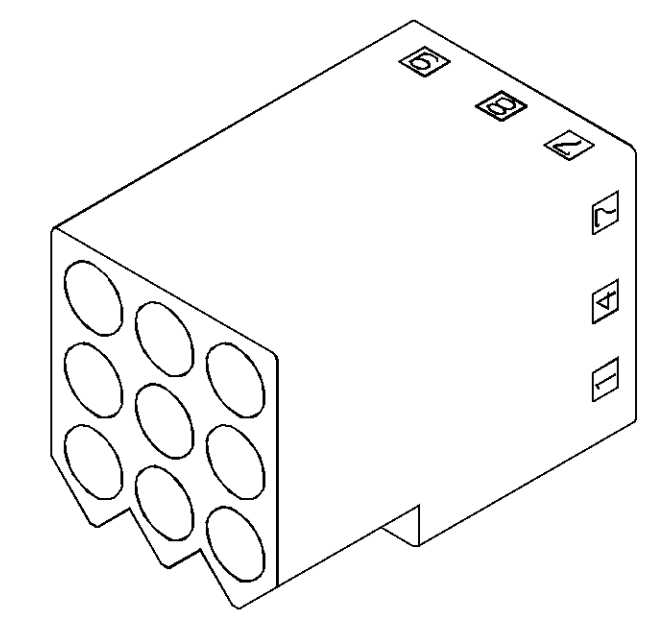

3D MODEL NTS

770094-1
 PART NUMBER

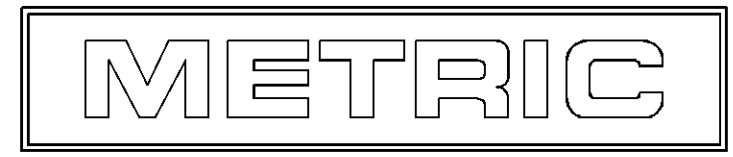

THIS DRAWING IS A CONTROLLED DOCUMENT.		DWN J. HUFFMAN 10-11-96	AMP Incorporated Harrisburg, PA 17105-3608
DIMENSIONS: INCHES		CHK R. SWING 10-11-96	NAME C. CASH 10-16-96
TOLERANCES UNLESS OTHERWISE SPECIFIED:		APVD C. CASH 10-16-96	PRODUCT SPEC
0 PLC ±-	1 PLC ±-	APPLICATION SPEC	SIZE A1
2 PLC ±-	3 PLC ±0.13	RESTRICTED TO	CARE CODE 770094
4 PLC ±-	ANGLES ±-	WEIGHT	DRAWING NO 770094
MATERIAL △1	FINISH	CUSTOMER DRAWING	SCALE 4:1
		SHEET 1 of 1	REV E